

Oracle® Fusion Middleware

Administrator's Guide for Oracle Access Management

11g Release 2 (11.1.2.3) for All Platforms

E54424-09

July 2017

Oracle Fusion Middleware Administrator's Guide for Oracle Access Management, 11g Release 2 (11.1.2.3) for All Platforms

E54424-09

Copyright © 2000, 2017, Oracle and/or its affiliates. All rights reserved.

Primary Author: Vinayak Lokhande

Contributing Authors: Annapoorna Jagannathan, Kavitha Ramasamy, Binitha Monnappa, Vagdevi Jayashankar

Contributors: Deepak Ramakrishnan, Vamsi Motokuru, Damien Carru, Peter Povinec, Weifang Xie, Satish Madawand, Neelima Jadhav, Charles Wesley, Harshal X Shaw, Jeremy Banford, Rey Ong, Ramana Turlapati, David Goldsmith, Vishal Parashar, Carlos Subi, Patricia Fuzesy

This software and related documentation are provided under a license agreement containing restrictions on use and disclosure and are protected by intellectual property laws. Except as expressly permitted in your license agreement or allowed by law, you may not use, copy, reproduce, translate, broadcast, modify, license, transmit, distribute, exhibit, perform, publish, or display any part, in any form, or by any means. Reverse engineering, disassembly, or decompilation of this software, unless required by law for interoperability, is prohibited.

The information contained herein is subject to change without notice and is not warranted to be error-free. If you find any errors, please report them to us in writing.

If this is software or related documentation that is delivered to the U.S. Government or anyone licensing it on behalf of the U.S. Government, then the following notice is applicable:

U.S. GOVERNMENT END USERS: Oracle programs, including any operating system, integrated software, any programs installed on the hardware, and/or documentation, delivered to U.S. Government end users are "commercial computer software" pursuant to the applicable Federal Acquisition Regulation and agency-specific supplemental regulations. As such, use, duplication, disclosure, modification, and adaptation of the programs, including any operating system, integrated software, any programs installed on the hardware, and/or documentation, shall be subject to license terms and license restrictions applicable to the programs. No other rights are granted to the U.S. Government.

This software or hardware is developed for general use in a variety of information management applications. It is not developed or intended for use in any inherently dangerous applications, including applications that may create a risk of personal injury. If you use this software or hardware in dangerous applications, then you shall be responsible to take all appropriate fail-safe, backup, redundancy, and other measures to ensure its safe use. Oracle Corporation and its affiliates disclaim any liability for any damages caused by use of this software or hardware in dangerous applications.

Oracle and Java are registered trademarks of Oracle and/or its affiliates. Other names may be trademarks of their respective owners.

Intel and Intel Xeon are trademarks or registered trademarks of Intel Corporation. All SPARC trademarks are used under license and are trademarks or registered trademarks of SPARC International, Inc. AMD, Opteron, the AMD logo, and the AMD Opteron logo are trademarks or registered trademarks of Advanced Micro Devices. UNIX is a registered trademark of The Open Group.

This software or hardware and documentation may provide access to or information about content, products, and services from third parties. Oracle Corporation and its affiliates are not responsible for and expressly disclaim all warranties of any kind with respect to third-party content, products, and services unless otherwise set forth in an applicable agreement between you and Oracle. Oracle Corporation and its affiliates will not be responsible for any loss, costs, or damages incurred due to your access to or use of third-party content, products, or services, except as set forth in an applicable agreement between you and Oracle.

Contents

Preface	lxiii
Audience	lxiii
Documentation Accessibility	lxiii
Related Documents.....	lxiii
Conventions.....	lxiv
What's New in This Guide?	lxv
Updates in July 2017 Documentation Refresh for 11g Release 2 (11.1.2.3.0).....	lxv
Updates in January 2017 Documentation Refresh for 11g Release 2 (11.1.2.3.0).....	lxv
Updates in October 2016 Documentation Refresh for 11g Release 2 (11.1.2.3.0).....	lxvi
Updates in August 2016 Documentation Refresh for 11g Release 2 (11.1.2.3.0).....	lxvii
Product Enhancements for Oracle Access Management 11.1.2.3.0	lxvii
Product Enhancements for Oracle Access Management 11.1.2.2.0	lxviii
Product Enhancements for Oracle Access Management 11.1.2.1.0	lxix
Product Enhancements in Oracle Access Management 11.1.2.0.0	lxx
November 2012 Book Refresh.....	lxxi
August 2012 Book Refresh	lxxii
Access Management Services	lxxii
Access Tester	lxxii
Attribute Type Authorization Condition.....	lxxiii
Deprecation	lxxiii
Detached Credential Collection	lxxiii
Dynamic Multi-Factor/Multi-Step Authentication.....	lxxiv
Identity Context.....	lxxiv
Integration with Third Party Products.....	lxxiv
LDAP Search Filters in Identity Conditions	lxxiv
Leverage SubjectAltName Extension Data/Integrate with Multiple OCSP Endpoints	lxxv
Mobile and Social	lxxv
Multiple Identity Store Support	lxxv
OpenSSO Support	lxxvi
Password Policy Management	lxxvi
Query String Name and Value Parameters in a Resource Definition Pattern	lxxvi

Resource Type TokenServiceRP for Non-Browser Client-enabled WebGate	lxxvi
RESTful Services	lxxvii
Shared Secret Key: Access Client and Software Developer Kit Enhancement	lxxvii
Token Issuance Policy for Mobile and Social	lxxvii
Tuning Performance	lxxviii
User-Defined Parameters: 11g WebGate	lxxviii
Product and Component Name Changes with 11.1.2	lxxviii

Part I Introduction to Oracle Access Management

1 Introducing Oracle Access Management

1.1 Understanding Oracle Access Management Services	1-1
1.2 Understanding Oracle Access Management Access Manager.....	1-4
1.2.1 About Components in Access Manager.....	1-4
1.2.2 Understanding Access Manager Deployments	1-6
1.3 About Access Manager 11.1.2.3.0	1-7
1.3.1 Features of Access Manager 11.1.2.3.0.....	1-7
1.3.2 Features Not In Access Manager 11.1.2.3.0.....	1-10
1.4 System Requirements and Certification	1-11
1.5 Understanding Oracle Access Management Installation.....	1-11
1.5.1 About Oracle Access Management Installation	1-11
1.5.2 Oracle Access Management and WebGates	1-12
1.5.3 About Oracle Access Management Post-Installation Tasks.....	1-12

2 Getting Started with Oracle Access Management

2.1 Starting and Stopping Servers in Your Deployment	2-1
2.1.1 Starting Node Manager	2-1
2.1.2 Starting and Stopping WebLogic AdminServer	2-2
2.1.3 Starting and Stopping Managed WebLogic Servers and Access Manager Servers....	2-3
2.2 About Oracle Access Management Administrators	2-3
2.3 Oracle Access Management Console and the Policy Manager Console.....	2-4
2.4 Understanding the Oracle Access Management Console	2-5
2.4.1 System Launch Pad.....	2-6
2.4.2 Access Manager Launch Pad.....	2-7
2.4.3 Agents Launch Pad	2-7
2.4.4 Help Desk Launch Pad	2-7
2.4.5 Self Service Launch Pad.....	2-8
2.5 About Logging Into the Oracle Access Management Console	2-8
2.5.1 Logging Into The Oracle Access Management Console.....	2-9
2.5.2 Logging Into the Secure Oracle Access Management Console (HTTPS).....	2-10
2.6 Using the Oracle Access Management Console	2-11
2.6.1 Logging Out of the Oracle Access Management Console	2-12
2.6.2 Accessing Online Help in the Oracle Access Management Console	2-12

2.6.3 SSO Agent Search Page	2-13
2.7 Command-Line Tools for Configuration	2-13
2.8 Logging, Auditing, Reporting, and Monitoring Performance	2-14
2.9 Configuring Oracle Access Management Login Options	2-14
2.9.1 Administering the Forgot Password URL	2-14
2.9.2 Choosing a User Login Language.....	2-15
2.9.3 Understanding Persistent Login	2-19

Part II Managing Common and System Configurations

3 Managing Common Services and Certificate Validation

3.1 Configuration Options in Oracle Access Management Console	3-1
3.2 Available Services of the Common Configuration Section	3-3
3.2.1 Enabling or Disabling Available Services.....	3-5
3.3 Common Settings.....	3-6
3.3.1 Managing Common Settings	3-7
3.3.2 Viewing Common Coherence Settings	3-8
3.4 Certificate Validation and Revocation.....	3-9
3.4.1 Enabling the Certificate Revocation List Functionality	3-9
3.4.2 Enabling OCSP Certificate Validation	3-10
3.4.3 Enabling CRL Distribution Point Extensions.....	3-11
3.4.4 Additional OCSP Configurations	3-11
3.5 WLST updateHTTPProxyConfig.....	3-13
3.6 WLST configureOAMOSCSPCertValidation	3-14

4 Delegating Administration

4.1 Understanding Administrator Roles	4-1
4.2 About Delegating the Identity Store.....	4-2
4.3 Assigning Roles Using the Administration Console.....	4-3
4.4 Understanding the Container Security Framework and MBeans	4-3
4.5 Using the Remote Registration Utility.....	4-4
4.6 About Auditing Reports	4-5

5 Managing Data Sources

5.1 Data Sources for Oracle Access Management	5-1
5.1.1 oam-config.xml Configuration Data File	5-4
5.1.2 About the Default LDAP Group	5-4
5.2 Registering and Managing User Identity Stores	5-5
5.2.1 Understanding User Identity Stores	5-5
5.2.2 About using the System Store for User Identities	5-6
5.2.3 About Using Multiple Identity Stores	5-7
5.2.4 User Identity Store Settings	5-9
5.2.5 Registering a New User Identity Store.....	5-15

5.2.6	Viewing or Editing a User Identity Store Registration	5-16
5.2.7	Deleting a User Identity Store Registration.....	5-17
5.3	Managing the Identity Directory Service User Identity Stores	5-17
5.3.1	Identity Directory Services.....	5-18
5.3.2	Creating an Identity Directory Service Profile.....	5-20
5.3.3	Editing or Deleting an Identity Directory Service Profile	5-24
5.3.4	Creating a Form-fill Application Identity Directory Service Profile.....	5-28
5.3.5	Understanding the Pre-Configured Identity Directory Service Profile	5-28
5.3.6	Creating an Identity Directory Service Repository	5-28
5.4	Managing Administrator Roles	5-30
5.4.1	Understanding Administrator Roles	5-30
5.4.2	Defining and Removing Administrator Roles	5-31
5.5	Managing the Policy and Session Database	5-32
5.5.1	About the Database Store for Policy, Password Management, and Sessions.....	5-33
5.5.2	About Database Deployment	5-33
5.5.3	Configuring a Separate Database for Access Manager Sessions	5-34
5.6	Introduction to Oracle Access Management Keystores	5-35
5.6.1	Access Manager Security Keys and the Embedded Java Keystore.....	5-35
5.6.2	Access Manager Keystores.....	5-36
5.6.3	Identity Federation Keystore	5-38
5.7	Integrating a Supported LDAP Directory with Oracle Access Manager	5-38

6 Managing Server Registration

6.1	Before You Register	6-1
6.2	Understanding OAM Server Registration and Management	6-1
6.2.1	About Individual OAM Server Registrations	6-2
6.2.2	About the Embedded Proxy Server and Backward Compatibility.....	6-3
6.2.3	About 11g SSO, Legacy 10g SSO in Combination with OSSO 10g	6-3
6.2.4	About Communication Between OAM Servers and WebGates.....	6-4
6.2.5	Conditions Requiring Server Restart.....	6-5
6.3	Managing Individual OAM Server Registrations	6-5
6.3.1	OAM Server Registration Page	6-5
6.3.2	Registering a Fresh OAM Server Instance.....	6-9
6.3.3	Viewing or Editing Individual OAM Server Registrations and Proxy Settings	6-10
6.3.4	Deleting an Individual Server Registration.....	6-11

Part III Logging, Auditing, Reporting and Monitoring Performance

7 Logging Component Event Messages

7.1	About Oracle Access Management Logging	7-1
7.2	Logging Component Event Messages	7-1
7.2.1	Component Loggers for Security Token Service and Access Manager.....	7-3
7.2.2	Sample Logger and Log Handler Definition.....	7-5

7.2.3	About Logging Levels	7-5
7.3	Configuring Logging for Access Manager	7-6
7.3.1	Modifying the Logger Level for Access Manager	7-7
7.3.2	Adding an Access Manager-Specific Logger and Log Handler	7-8
7.4	Configuring Logging for Security Token Service and Identity Federation	7-10
7.4.1	Configuring Logging for Security Token Service or Identity Federation	7-10
7.4.2	Defining Log Level and Log Details for Security Token Service or Identity Federation	7-11
7.5	Mobile and Social Logging	7-12
7.6	Logging for the Access Portal Service.....	7-12
7.7	Validating Run-time Event Logging Configuration.....	7-12

8 Auditing Administrative and Run-time Events

8.1	Introduction to Oracle Fusion Middleware Auditing	8-1
8.2	Oracle Access Management Auditing	8-2
8.2.1	Understanding Oracle Access Management Auditing	8-2
8.2.2	About Oracle Access Management Auditing Configuration	8-3
8.2.3	About Audit Record Storage	8-3
8.2.4	About Audit Reports and Oracle Business Intelligence Publisher	8-5
8.2.5	Oracle BI Enterprise Edition (Oracle BI EE)	8-5
8.2.6	About the Audit Log and Data.....	8-7
8.3	Access Manager Events You Can Audit.....	8-7
8.3.1	Access Manager Administrative Events You Can Audit	8-7
8.3.2	Access Manager Run-time Events You Can Audit.....	8-10
8.3.3	Auditing Authentication Events	8-12
8.3.4	Auditing Events for Delegated Administrators.....	8-13
8.4	Mobile and Social Events You Can Audit.....	8-14
8.4.1	REST Run-Time Audit Events	8-14
8.4.2	Mobile and Social Audit Events	8-15
8.5	Identity Federation Events You Can Audit	8-16
8.5.1	Session Management Events for Identity Federation	8-17
8.5.2	Protocol Flow Events for Identity Federation	8-18
8.5.3	Server Configuration Events for Identity Federation	8-18
8.5.4	Security Events for Identity Federation	8-19
8.6	Security Token Service Events You Can Audit	8-20
8.6.1	About Audit Record Content Common to All Events	8-20
8.6.2	Security Token Service Administrative Events You Can Audit.....	8-20
8.6.3	Security Token Service Run-time Events You Can Audit	8-23
8.7	Setting Up Auditing for Oracle Access Management	8-24
8.7.1	Setting Up the Audit Database Store.....	8-25
8.7.2	Preparing Oracle Business Intelligence Publisher EE	8-26
8.7.3	Using the Oracle Access Management Console for Audit Configuration	8-27
8.7.4	Adding, Viewing, or Editing Audit Settings	8-29

8.8	Validating Auditing and Reports	8-29
9	Logging WebGate Event Messages	
9.1	Understanding Logging for WebGate instances	9-1
9.1.1	About Logging, Log Levels, and Log Output	9-2
9.1.2	Log Levels.....	9-2
9.1.3	Log Output	9-4
9.2	About Log Configuration File Paths and Contents	9-5
9.2.1	Log Configuration File Paths and Names.....	9-5
9.2.2	Log Configuration File Contents.....	9-6
9.3	About Directing Log Output to a File or the System File	9-10
9.4	Structure and Parameters of the WebGate Log Configuration File	9-11
9.4.1	Structure of WebGate Log Configuration XML File Header	9-11
9.4.2	Structure of WebGate Initial Compound List	9-11
9.4.3	Parameters in the WebGate Simple List and Logging Threshold	9-12
9.4.4	Parameters in the WebGate Second Compound List and Log Handlers.....	9-13
9.4.5	Parameters in the WebGate List for Per-Module Logging.....	9-15
9.4.6	Parameters in the WebGate Filter List.....	9-15
9.4.7	WebGate XML Element Order	9-16
9.5	Activating and Suppressing Logging Levels.....	9-16
9.5.1	About Log Handler Precedence	9-17
9.6	Mandatory Log Configuration File Parameters	9-17
9.6.1	Settings in the Default Log Configuration File	9-19
9.6.2	Description of the Settings in the Default Log Configuration File.....	9-21
9.7	Configuring Different Threshold Levels for Different Types of Data	9-23
9.7.1	About the MODULE_CONFIG Section	9-23
9.7.2	Configuring a Log Level Threshold for a Function or Module	9-26
9.8	Filtering Sensitive Attributes	9-28
10	Understanding Oracle Access Management Reports	
10.1	About Reports in Oracle Access Management.....	10-1
10.2	Accessing Oracle Access Management Reports.....	10-2
10.3	Supported Output Formats	10-3
10.4	Classification of Reports for Access Manager	10-3
10.4.1	Account Management Reports.....	10-3
10.4.2	Authentication Reports.....	10-3
10.4.3	Errors and Exceptions.....	10-5
10.5	About Creating Reports Using Third-Party Software.....	10-7
11	Monitoring Oracle Access Management Performance and Access Manager Health	
11.1	Introduction to Performance Monitoring.....	11-1
11.2	Monitoring Server Metrics Using Oracle Access Management Console.....	11-2
11.2.1	Monitoring Server Instance Performance	11-2

11.2.2	Oracle Access Manager Server Metrics	11-2
11.3	Monitoring SSO Agent Metrics Using Oracle Access Management Console	11-6
11.3.1	WebGate Metrics	11-7
11.3.2	OSSO Agent Metrics	11-8
11.4	OAM Proxy Metrics and Tuning	11-9
11.4.1	OAM Proxy Metrics	11-10
11.4.2	OAM Proxy Server Tuning Parameters	11-10
11.5	Monitoring Metrics Using the DMS Console	11-11
11.5.1	Monitoring OAM Metrics	11-11
11.5.2	Monitoring Coherence Caches	11-12
11.5.3	Monitoring OpenSSO Proxy Metrics	11-13
11.6	Monitoring the Health of an Access Manager Server	11-15
11.6.1	Understanding WebGate and Access Manager Communications	11-15
11.6.2	Monitoring Access Manager Server Health	11-16

12 Monitoring Performance and Logs with Fusion Middleware Control

12.1	Introduction to Fusion Middleware Control	12-1
12.2	Logging In to and Out of Fusion Middleware Control	12-2
12.2.1	Logging In To Fusion Middleware Control	12-3
12.2.2	Logging Out of Fusion Middleware Control	12-3
12.3	Displaying Menus and Pages in Fusion Middleware Control	12-3
12.3.1	Farm Page in Fusion Middleware Control	12-4
12.3.2	Context Menus and Pages in Fusion Middleware Control	12-5
12.3.3	Displaying Context Menus and Target Details in Fusion Middleware Control	12-8
12.4	Viewing Performance in Fusion Middleware Control	12-9
12.4.1	Resulting Pages for Selected Nodes and Targets	12-9
12.4.2	Performance Overview Pages in Fusion Middleware Control	12-10
12.4.3	Metrics Palette and the Performance Summary Page	12-17
12.4.4	Displaying Performance Metrics in Fusion Middleware Control	12-20
12.4.5	Displaying Component-Specific Performance Details	12-22
12.5	Managing Log Level Changes in Fusion Middleware Control	12-22
12.5.1	Dynamic Log Level Changes in Fusion Middleware Control	12-23
12.5.2	Setting Log Levels Dynamically Using Fusion Middleware Control	12-26
12.6	Managing Log File Configuration from Fusion Middleware Control	12-27
12.6.1	Log File Configuration Page in Fusion Middleware Control	12-27
12.6.2	Managing Log Files with Fusion Middleware Control	12-29
12.7	Viewing Log Messages in Fusion Middleware Control	12-30
12.7.1	About Finding, Viewing, and Exporting Log Messages	12-30
12.7.2	Viewing Logged Messages With Fusion Middleware Control	12-34
12.8	Displaying MBeans in Fusion Middleware Control	12-36
12.8.1	Fusion Middleware Control System MBean Browser	12-36
12.8.2	Managing Mbeans	12-39

Part IV Managing Access Manager Settings and Agents

13 Configuring Access Manager Settings

13.1	Oracle Access Management Overview	13-1
13.2	Managing Load Balancing	13-1
13.2.1	About Common Load Balancing Settings	13-1
13.2.2	Managing OAM Server Load Balancing Settings	13-2
13.3	Managing Secure Error Modes	13-3
13.3.1	OAM Server Error Modes	13-3
13.3.2	Viewing or Editing OAM Server Secure Error Modes.....	13-6
13.4	Managing SSO Tokens and IP Validation	13-6
13.4.1	Access Manager SSO Tokens and IP Validation Settings.....	13-6
13.4.2	Viewing or Editing SSO Tokens and IP Validation.....	13-7
13.5	Managing the Access Protocol for OAM Proxy Simple and Cert Mode Security	13-7
13.5.1	OAM Proxy Simple and Cert Mode Transport Security	13-8
13.5.2	Configuration Settings of Common OAM Proxy Page for Secure Server Communications.....	13-10
13.5.3	Viewing or Editing Simple or Cert Settings for OAM Proxy	13-10
13.5.4	Configuring 64-bit WebGate in Cert Mode	13-11
13.5.5	Tuning the Simple Mode WebGate	13-11
13.6	Managing Run Time Policy Evaluation Caches	13-11
13.6.1	Settings for Run Time Policy Evaluation Caches.....	13-12
13.6.2	Managing Run Time Policy Evaluation Caches.....	13-12

14 Introduction to Agents and Registration

14.1	Introduction to Policy Enforcement Agents	14-1
14.1.1	Agent Types and Runtime Processing for OAM Agents.....	14-1
14.1.2	About 11g WebGate Configured as a Detached Credential Collector	14-6
14.1.3	About 11g WebGate Functionality for Mobile and Social	14-6
14.1.4	About the Pre-Registered 10g WebGate IAMSuiteAgent	14-7
14.2	Introduction to Agent Registration	14-7
14.2.1	Keys and Policies Generated during Agent Registration.....	14-7
14.2.2	File System Changes and Artifacts for Registered Agents.....	14-8
14.3	OAM Remote Registration	14-10
14.3.1	Performing In-Band Remote Registration	14-11
14.3.2	Performing Out-of-Band Remote Registration	14-11
14.3.3	Updating Agent Configuration Files.....	14-12

15 Registering and Managing OAM 11g Agents

15.1	Before Registering and Managing Agents	15-1
15.2	OAM Agent Registration Parameters in the Console.....	15-2
15.2.1	Creating OAM WebGate Page and Parameters.....	15-2

15.2.2	User-Defined WebGate Parameters.....	15-7
15.2.3	IP Address Validation for WebGates	15-13
15.3	Registering an OAM Agent Using the Console	15-16
15.4	Bulk Updates to WebGates.....	15-18
15.4.1	Updating Multiple WebGate Profiles.....	15-18
15.4.2	WLST Commands for Bulk Updates to WebGate Profiles.....	15-19
15.5	Configuring and Managing Registered OAM Agents Using the Console.....	15-23
15.5.1	Registered OAM Agent Configuration Parameters in the Console.....	15-23
15.5.2	WebGate Search Controls.....	15-31
15.5.3	Viewing or Editing an OAM Agent Registration Page in the Console	15-33
15.5.4	Deleting OAM Agent Registration Using the Console	15-34
15.6	Remote Registration Tool, Modes, and Process	15-35
15.6.1	Remote Registration Command Arguments and Modes	15-35
15.6.2	Common Elements within Remote Registration Request Templates.....	15-37
15.6.3	Key Use, Generation, Provisioning, and Storage.....	15-39
15.7	Remote Registration Templates: OAM Agents	15-40
15.7.1	OAM Agent Parameters for Remote Registration.....	15-41
15.8	Performing Remote Registration for OAM Agents	15-46
15.8.1	Acquiring and Setting Up the Remote Registration Tool	15-46
15.8.2	Creating Your Remote Registration Request	15-47
15.8.3	Performing In-Band Remote Registration	15-48
15.8.4	Performing Out-of-Band Remote Registration	15-49
15.9	Remote Agent Update Modes and Templates.....	15-51
15.9.1	Remote Agent Update Modes	15-51
15.9.2	Remote 11g OAM Agent Updates Template.....	15-52
15.10	Updating Agents Remotely	15-53
15.10.1	Updating Agent Registrations Remotely	15-53
15.10.2	Validating an Agent Registration Remotely.....	15-54
15.10.3	Removing an Agent Registration Remotely	15-54
15.11	Validating Remote Registration and Resource Protection	15-55
15.11.1	Validating Agent Registration using the Oracle Access Management Console ..	15-55
15.11.2	Verifying Authentication and Access After Remote Registration	15-55
15.12	Replacing the IAMSuiteAgent with an 11g WebGate	15-57
15.12.1	Registering a Replacement 11g WebGate for IAMSuiteAgent	15-58
15.12.2	Installing the Replacement 11g WebGate for IAMSuiteAgent	15-60
15.12.3	Updating the WebLogic Server Plug-in Configuration	15-60
15.12.4	Confirming the AutoLogin Host Identifier for an OAM / OIG Integration	15-61
15.12.5	Configuring OAM Security Providers for WebLogic	15-62
15.12.6	Disabling IAMSuiteAgent	15-66
15.12.7	Verifying the Webgate Configuration.....	15-66
15.13	Managing the Preferred Host in 10g WebGates.....	15-67
15.14	setAllowEmptyHostIdentifier.....	15-67

16 Maintaining Access Manager Sessions

16.1	Introducing Access Manager Session Management	16-1
16.2	Understanding Server-Side Session Management.....	16-2
16.2.1	About Securing Access Manager Sessions.....	16-2
16.2.2	Access Manager Session Lifecycle, States, and Enforcement.....	16-3
16.2.3	Access Manager Sessions and the Role of Oracle Coherence	16-7
16.3	Server-Side Session Enforcement Examples	16-8
16.3.1	Example 1: Single Authentication Scheme	16-8
16.3.2	Example 2: Multiple Authentication Schemes	16-9
16.4	Configuring the Server-Side Session Lifecycle	16-10
16.4.1	Global Session Lifecycle Settings	16-11
16.4.2	Application-Specific Session Overrides	16-12
16.4.3	Viewing or Modifying Global Session Settings	16-13
16.4.4	Viewing or Modifying Optional Application-Specific Session Overrides.....	16-14
16.5	Managing Active Server-Side Sessions.....	16-14
16.5.1	Session Management Controls	16-14
16.5.2	Locating and Managing Active Sessions	16-17
16.6	Validating Server-Side Session Operations.....	16-18
16.7	Understanding Client-Side Session Management	16-19
16.8	Using WLST To Configure Session Management.....	16-19
16.8.1	displaySSOSessionType	16-19
16.8.2	configSSOSessionType	16-20

Part V Implementing Multi-Data Centers

17 Understanding Multi-Data Centers

17.1	Introducing the Multi-Data Center	17-1
17.1.1	Understanding Cookies for Multi-Data Center	17-3
17.1.2	Session Adoption During Authorization.....	17-5
17.1.3	Session Indexing	17-5
17.1.4	Supported Multi-Data Center Topologies	17-6
17.2	Multi-Data Center Deployments.....	17-8
17.2.1	Session Adoption Without Re-authentication, Session Invalidation or Session Data Retrieval	17-9
17.2.2	Session Adoption Without Re-authentication But With Session Invalidation and Session Data Retrieval.....	17-10
17.2.3	Session Adoption Without Re-authentication and Session Invalidation But With On-demand Session Data Retrieval	17-11
17.2.4	Authentication and Authorization Requests Served By Different Data Centers...	17-11
17.2.5	Logout and Session Invalidation.....	17-14
17.2.6	Stretch Cluster Deployments.....	17-15
17.3	Active-Active Multi-Data Center Topology Deployment	17-17

17.4	Load Balancing Between Access Management Components.....	17-19
17.5	Understanding Time Outs and Session Syncs.....	17-21
17.5.1	Maximum Session Constraints.....	17-21
17.5.2	Multi-Data Center Policy Configurations for Idle Timeout.....	17-21
17.5.3	Expiring Multi-Data Center Sessions.....	17-22
17.5.4	Session Synchronization and Multi-Data Center Fail Over.....	17-22
17.6	Replicating a Multi-Data Center Environment.....	17-24
17.6.1	Replicating Data Using the WLST.....	17-25
17.6.2	Syncing Data Using Automated Policy Synchronization.....	17-25
17.7	Multi-Data Center Recommendations.....	17-25
17.7.1	Using a Common Domain.....	17-26
17.7.2	Concerning the DCC and the OAM_GITO.....	17-26
17.7.3	Using an External Load Balancer.....	17-27
17.7.4	Honoring Maximum Sessions.....	17-27
17.7.5	WebGate Cookie Cannot Be Refreshed During Authorization.....	17-27
18	Configuring Multi-Data Centers	
18.1	Before Setting Up a Multi-Data Center.....	18-1
18.2	Primary Multi-Data Center Use Cases.....	18-2
18.3	Setting Up a Multi-Data Center.....	18-2
18.3.1	Enabling the Master Data Center.....	18-3
18.3.2	Setting Up the Clone Data Center.....	18-3
18.4	Adding A Second Clone to An Existing Multi-Data Center Setup.....	18-5
18.5	Multi-Data Center Security Modes.....	18-6
18.5.1	OPEN Security Mode.....	18-6
18.5.2	SIMPLE Security Mode.....	18-6
18.5.3	CERT Security Mode.....	18-7
18.6	WLST Commands for Multi-Data Centers.....	18-9
18.7	enableMultiDataCentreMode.....	18-9
18.8	disableMultiDataCentreMode.....	18-12
18.9	addPartnerForMultiDataCentre.....	18-12
18.10	removePartnerForMultiDataCentre.....	18-14
18.11	setMultiDataCenterType.....	18-14
18.12	setMultiDataCenterWrite.....	18-15
18.13	setMultiDataCentreClusterName.....	18-15
18.14	validateMDCCConfig.....	18-15
18.15	exportAccessStore.....	18-16
18.16	importAccessStore.....	18-16
19	Synchronizing Data In A Multi-Data Center	
19.1	Understanding the Multi-Data Center Synchronization.....	19-1
19.1.1	How Replication Works.....	19-2
19.1.2	Understanding the Replication Agreement.....	19-4

19.1.3	About Synchronizing Data Manually in a Multi-Data Center.....	19-4
19.2	Enabling Data Replication.....	19-4
19.3	Synchronizing Master and Clone Metadata.....	19-5
19.3.1	Synchronizing the UDM Metadata.....	19-5
19.3.2	Creating a Replication Agreement.....	19-5
19.3.3	Modifying a Replication Agreement.....	19-8
19.4	Customizing Transformation Rules.....	19-10
19.5	Modifying a Rule Document.....	19-12
19.6	Using REST API for Replication Agreements.....	19-14
19.6.1	Querying for Replication Agreement Details.....	19-14
19.6.2	Modifying an Existing Replication Agreement.....	19-15
19.6.3	Deleting a Replication Agreement.....	19-16
19.7	Replicating Domains in Identity Manager Deployments.....	19-16
19.8	Best Practices for Replication.....	19-17
19.8.1	Enabling Replication Logs.....	19-17
19.8.2	Changing the User Identifier.....	19-18

20 Setting Up the Multi-Data Center: A Sequence

20.1	Before You Begin.....	20-1
20.2	Setting Up a Multi-Data Center.....	20-2
20.3	Enabling Automated Policy Synchronization.....	20-10
20.4	Troubleshooting the Multi-Data Center Setup.....	20-11

Part VI Managing Access Manager SSO, Policies, and Testing

21 Understanding Single Sign-On with Access Manager

21.1	Access Manager Single Sign-On Components.....	21-1
21.1.1	Multiple Network Domain SSO.....	21-4
21.1.2	Application SSO and Access Manager.....	21-5
21.1.3	Multiple WebLogic Server Domain SSO.....	21-6
21.1.4	Reverse-Proxy SSO.....	21-7
21.2	Access Manager Policy Model.....	21-7
21.3	Anatomy of an Application Domain and Policies.....	21-11
21.3.1	Resource Definitions for Policies.....	21-12
21.3.2	About Authentication Policies.....	21-13
21.3.3	About Authorization Policies.....	21-14
21.3.4	About Token Issuance Policies.....	21-14
21.4	Policy Conditions and Rules.....	21-15
21.5	Understanding SSO Cookies.....	21-16
21.5.1	Single Sign-On Cookies During User Login.....	21-16
21.5.2	Single Sign-On Server and Agent Cookies.....	21-18
21.6	Configuring Single Sign-On with Access Manager.....	21-23

22 Managing Authentication and Shared Policy Components

22.1 Prerequisites to Managing Authentication and Shared Policy Components	22-1
22.2 Configuring Shared Policy Components.....	22-1
22.3 Managing Resource Types	22-2
22.3.1 Resource Types and Their Use	22-3
22.3.2 Resource Type Page	22-4
22.3.3 Searching for a Specific Resource Type.....	22-7
22.3.4 Creating a Custom Resource Type	22-7
22.4 Managing Host Identifiers.....	22-8
22.4.1 About Host Identifiers.....	22-8
22.4.2 About Virtual Web Hosting.....	22-11
22.4.3 Host Identifier Page	22-15
22.4.4 Creating a Host Identifier.....	22-16
22.4.5 Searching for a Host Identifier Definition	22-17
22.4.6 Viewing or Editing a Host Identifier Definition	22-18
22.4.7 Deleting a Host Identifier Definition.....	22-18
22.5 Understanding Authentication Methods and Credential Collectors.....	22-19
22.5.1 Authentication Methods Supported by Access Manager.....	22-19
22.5.2 Embedded Credential Collector Versus Detached Credential Collector	22-21
22.5.3 Authentication Event Logging and Auditing	22-27
22.6 Managing Native Authentication Modules.....	22-28
22.6.1 Native Access Manager Authentication Modules.....	22-28
22.6.2 Viewing or Editing Native Authentication Modules.....	22-33
22.6.3 Deleting a Native Authentication Module	22-34
22.7 Orchestrating Multi-Step Authentication with Plug-in Based Modules	22-34
22.7.1 Simple Form Versus Multi-Factor (Multi-Step) Authentication.....	22-35
22.7.2 Access Manager Plug-ins for Multi-Step Authentication Modules	22-36
22.7.3 Pre-populated Plug-ins for Configuring Access Manager with Multi-Step Authentication.....	22-48
22.7.4 Example: Leveraging SubjectAltName Extension Data and Integrating with Multiple OCSP Endpoints	22-53
22.7.5 Creating a Custom Authentication Module using Bundled Plug-ins	22-55
22.7.6 Steps and Plug-ins in Customized Step-up Authentication Module.....	22-57
22.7.7 Configuring Step-up Authentication.....	22-59
22.7.8 Configuring an HTTPToken Extractor Plug-in.....	22-63
22.7.9 JSON Web Token Plug-in.....	22-64
22.8 Deploying and Managing Individual Plug-ins for Authentication.....	22-66
22.8.1 About Managing Your Own Authentication Plug-ins.....	22-66
22.8.2 Making Custom Authentication Plug-ins Available for Use	22-70
22.8.3 Checking an Authentication Plug-in's Activation Status	22-71
22.8.4 Deleting Your Custom Authentication Plug-ins.....	22-71
22.9 Managing Authentication Schemes	22-72

22.9.1	Authentication Schemes and Pages	22-72
22.9.2	Understanding Multi-Level and Step-Up Authentication	22-94
22.9.3	Creating an Authentication Scheme	22-97
22.9.4	Searching for an Authentication Scheme	22-98
22.9.5	Viewing, Editing, or Deleting an Authentication Scheme	22-99
22.10	Extending Authentication Schemes with Advanced Rules	22-100
22.10.1	Advanced Rules Use Cases	22-101
22.10.2	Context Data for Advanced Rules	22-102
22.11	Configuring Challenge Parameters for Encrypted Cookies	22-104
22.11.1	Challenge Parameters for Encrypted Cookies	22-104
22.11.2	Configuring Challenge Parameters for Security of Encrypted Cookies.....	22-106
22.11.3	Setting Challenge Parameters for Persistence of Encrypted Cookies.....	22-106
22.12	Configuring Authentication POST Data Handling	22-107
22.12.1	Authentication POST Data Preservation and Restoration	22-107
22.12.2	Authentication POST Data Handling	22-109
22.12.3	Post Data Size Limits	22-111
22.12.4	Configuring Authentication POST Data Handling	22-111
22.12.5	Testing POST Data Handling Configuration	22-112
22.13	Long URL Handling During Authentication	22-113
22.13.1	About Long URLs and Authentication Handling	22-113
22.13.2	Configuration Requirements for Long URL Handling.....	22-114
22.14	Using Application Initiated Authentication	22-116

23 Understanding Credential Collection and Login

23.1	Overview of Access Manager Credential Collection.....	23-1
23.1.1	Overview of the Login process with Self-Service Provisioning Applications.....	23-2
23.1.2	Overview of the Login Process with Access Manager-Protected Resources.....	23-2
23.2	Overview of the SSO Login Process with OAM Agents and ECC	23-3
23.3	Overview of the SSO Login Process with OAM Agents and DCC	23-6
23.4	Overview of the SSO Login Process with OSSO Agents (mod_osso) and ECC.....	23-9
23.5	Configuring 11g WebGate and Authentication Policy for DCC.....	23-11
23.5.1	Enabling DCC Credential Operations.....	23-12
23.5.2	Locating and Updating DCC Forms for Password Policy	23-13
23.5.3	Adding PasswordPolicyValidationScheme to Authentication Policy for DCC.....	23-13
23.5.4	Supporting Federation Flows With DCC.....	23-15
23.6	Tunneling from DCC to Access Manager Over Oracle Access Protocol	23-16
23.6.1	How DCC Tunneling with OAP Works	23-16
23.6.2	Configuring OAP Tunneling	23-17
23.7	Configuring a DCC WebGate for X509 Authentication	23-17
23.7.1	Configuring the WebLogic Server	23-18
23.7.2	Configuring a WebGate For DCC	23-22
23.7.3	Converting the DCC WebGate to SSL.....	23-22

24 Using Password Policy

24.1	Understanding Password Management.....	24-1
24.2	Enabling Password Management.....	24-2
24.3	Accessing Password Policy Configuration Page.....	24-3
24.3.1	Password Policy Configuration Page.....	24-3
24.4	Specifying Credential Collector URLs with Password Policy.....	24-6
24.5	Oracle-Provided Password Forms	24-10
24.6	Managing Global Password Policy	24-13
24.6.1	Defining Your Global Password Policy	24-14
24.6.2	Designating the Default Store for Your Password Policy	24-14
24.6.3	Adding Key Password Attributes to the Default Store	24-15
24.6.4	Adding an Administrator to Change User Attributes After a Password Change..	24-18
24.7	Configuring Password Policy Authentication	24-19
24.7.1	Password Policy Validation Authentication Module	24-19
24.7.2	Configuring the PasswordPolicyValidationScheme	24-23
24.7.3	Adding Your PasswordPolicyValidationScheme to ECC Authentication Policy..	24-24
24.7.4	Supporting DCC Authentication Schemes with Pre-Authentication Rules	24-25
24.8	Completing Password Policy Configuration.....	24-26
24.8.1	Setting the Error Message Mode for Password Policy Messages.....	24-26
24.8.2	Overriding Native LDAP Password Policy Validation	24-26
24.8.3	Disabling ECC Operation and Using DCC Exclusively	24-27
24.8.4	Testing Your Multi-Step Authentication	24-28
24.9	Configuring the IPFUserPasswordPolicyPlugin.....	24-29
24.9.1	Enabling the IPF Password Service	24-30
24.9.2	Configuring Password Policy for IPF Password Service.....	24-30
24.9.3	Extending the LDAP Definitions	24-31
24.9.4	Configuring the Password Policy Validation Authentication Module and Scheme	24-31
24.9.5	Setting Up the Forgot Password Module.....	24-31

25 Managing Policies to Protect Resources and Enable SSO

25.1	Prerequisites to Managing Policies and Protecting Resources	25-1
25.2	Introduction to Application Domain and Policy Creation	25-2
25.2.1	About Generating Application Domains and Policies Automatically	25-3
25.2.2	About Managing Application Domains and Policies Remotely	25-4
25.2.3	Creating or Managing an Application Domain and Policies.....	25-4
25.3	Understanding Application Domain and Policy Management	25-5
25.3.1	Application Domain Pages	25-5
25.3.2	Application Domain Summary Page.....	25-6
25.3.3	Resource Container in an Application Domain.....	25-7
25.3.4	Authentication Policy Pages	25-7
25.3.5	Authorization Policy Pages.....	25-9
25.3.6	Token Issuance Policy Pages	25-10

25.4	Managing Application Domains Using the Console.....	25-11
25.4.1	Creating a New Application Domain.....	25-11
25.4.2	Searching for an Existing Application Domain	25-12
25.4.3	Viewing or Editing an Application Domain	25-13
25.4.4	Deleting an Application Domain and Its Contents	25-13
25.5	Adding and Managing Policy Resource Definitions	25-14
25.5.1	Resources in an Application Domain.....	25-14
25.5.2	Defining Resources in an Application Domain	25-29
25.5.3	Searching for a Resource Definition	25-30
25.5.4	Viewing, Editing, or Deleting a Resource Definition	25-32
25.6	Defining Authentication Policies for Specific Resources	25-33
25.6.1	Authentication Policy Page.....	25-33
25.6.2	Creating an Authentication Policy for Specific Resources	25-35
25.6.3	Searching for an Authentication Policy.....	25-36
25.6.4	Viewing or Editing an Authentication Policy	25-37
25.6.5	Deleting an Authentication Policy	25-37
25.7	Defining Authorization Policies for Specific Resources.....	25-38
25.7.1	Authorization Policies for Specific Resources.....	25-38
25.7.2	Creating an Authorization Policy and Specific Resources.....	25-39
25.7.3	Searching for an Authorization Policy	25-40
25.7.4	Viewing or Editing an Authorization Policy and Resources	25-41
25.7.5	Deleting an Entire Authorization Policy	25-41
25.8	Configuring Success and Failure URLs for Authorization Policies	25-42
25.9	Introduction to Authorization Policy Rules and Conditions	25-43
25.9.1	About Allow or Deny Rules.....	25-43
25.9.2	Authorization Policy Conditions	25-44
25.9.3	About Classifying Users and Groups for Conditions	25-45
25.9.4	Guidelines for Authorization Responses Based on Conditions	25-46
25.10	Defining Authorization Policy Conditions	25-46
25.10.1	Choosing a Condition Type	25-46
25.10.2	Defining Identity Conditions.....	25-48
25.10.3	Defining IP4 Range Conditions.....	25-56
25.10.4	Defining Temporal Conditions	25-59
25.10.5	Defining Attribute Conditions	25-61
25.10.6	Viewing, Editing, or Deleting Authorization Policy Conditions	25-65
25.11	Defining Authorization Policy Rules.....	25-66
25.11.1	Authorization Policy Rules	25-66
25.11.2	Expressions and Expression-Based Policy.....	25-69
25.11.3	Defining Rules in an Authorization Policy.....	25-72
25.12	Configuring Policy Ordering	25-73
25.13	Introduction to Policy Responses for SSO.....	25-75
25.13.1	Authentication and Authorization Policy Responses for SSO.....	25-75
25.13.2	About the Policy Response Language.....	25-77

25.13.3	Namespace and Variable Names for Policy Responses.....	25-78
25.13.4	About Constructing a Policy Response for SSO	25-79
25.13.5	About Policy Response Processing	25-82
25.13.6	Assertion Claims and Processing.....	25-82
25.14	Adding and Managing Policy Responses for SSO.....	25-83
25.14.1	Adding a Policy Response for SSO.....	25-83
25.14.2	Viewing, Editing, or Deleting a Policy Response for SSO.....	25-84
25.15	Validating Authentication and Authorization in an Application Domain.....	25-85
25.16	Understanding Remote Policy and Application Domain Management.....	25-86
25.16.1	Remote Policy Management Modes, Templates, and Flags.....	25-86
25.16.2	Create Policy Request Template.....	25-88
25.16.3	Update Policy Request Template.....	25-89
25.16.4	Remote Policy Management Template Elements	25-89
25.17	Managing Policies and Application Domains Remotely	25-91
25.18	Application and Application-types.....	25-92

26 Validating Connectivity and Policies Using the Access Tester

26.1	Prerequisites to Using the Access Tester to Validate Connectivity and Policies	26-1
26.2	Introduction to the Access Tester for Access Manager 11g	26-1
26.2.1	About OAM Agent and Server Interoperability	26-3
26.2.2	About Access Tester Security and Processing.....	26-5
26.2.3	About Access Tester Modes and Administrator Interactions	26-6
26.3	Installing and Starting the Access Tester	26-8
26.3.1	Installing the Access Tester.....	26-9
26.3.2	System Properties Supported by the Access Tester	26-10
26.3.3	Starting the Tester Without System Properties For Use in Tester Console Mode .	26-11
26.3.4	Starting the Access Tester with System Properties For Use in Command Line Mode.....	26-12
26.4	Access Tester Console, Navigation, and Controls	26-13
26.4.1	Access Tester Menus and Command Buttons.....	26-15
26.5	Testing Connectivity and Policies from the Access Tester Console.....	26-17
26.5.1	Establishing a Connection Between the Access Tester and the OAM Server.....	26-18
26.5.2	Validating Resource Protection from the Access Tester Console.....	26-21
26.5.3	Testing User Authentication from the Access Tester Console.....	26-23
26.5.4	Testing User Authorization from the Access Tester Console	26-26
26.5.5	Observing Request Latency	26-27
26.6	Creating and Managing Test Cases and Scripts.....	26-28
26.6.1	About Test Cases and Test Scripts	26-28
26.6.2	Capturing Test Cases	26-29
26.6.3	Generating an Input Test Script	26-30
26.6.4	Personalizing an Input Test Script.....	26-32
26.6.5	Executing a Test Script	26-33
26.7	Evaluating Scripts, Log File, and Statistics	26-36

26.7.1	About Evaluating Test Results	26-36
26.7.2	Saved Connection Configuration File	26-37
26.7.3	Generated Input Test Script	26-38
26.7.4	Target Output File Containing Test Run Results	26-39
26.7.5	Statistics Document.....	26-41
26.7.6	Execution Log	26-43
26.8	Validating User Authentication without Password	26-44

27 Configuring Centralized Logout for Sessions Involving 11g WebGates

27.1	Prerequisites for the Configuration of Centralized Logout Sessions Involving 11g WebGates	27-1
27.2	Introduction to Centralized Logout for Access Manager 11g.....	27-2
27.2.1	About Centralized Logout for 11g WebGates	27-2
27.2.2	About Logout Parameters for 11g WebGates.....	27-3
27.3	Configuring Centralized Logout for 11g WebGates.....	27-5
27.3.1	Configuring Centralized Logout for 11g WebGates When the ECC is Used	27-5
27.3.2	Configuring Logout When Using Detached Credential Collector-Enabled WebGate.....	27-6
27.4	Validating Global Sign-On and Centralized Logout	27-7
27.4.1	Confirming Global Sign-On.....	27-7
27.4.2	Validating Global Sign-On with Mixed Agent Types.....	27-8
27.4.3	Observing Centralized Logout.....	27-9

Part VII Registering and Using Agents with Access Manager

28 Registering and Managing Legacy OpenSSO Agents

28.1	Introduction to OpenSSO, Agents, Migration and Co-existence.....	28-1
28.1.1	About Migration and Co-existence Between OpenSSO and Access Manager	28-2
28.1.2	OpenSSO Agent Reliance on Access Manager.....	28-5
28.2	Runtime Processing Between OpenSSO Agents and Access Manager.....	28-8
28.3	Understanding OpenSSO Agent Registration Parameters	28-13
28.3.1	OpenSSO Agent Registration Parameters	28-13
28.3.2	The Expanded OpenSSO Agent Page and Parameters.....	28-15
28.4	Registering and Managing OpenSSO Agents Using the Console	28-27
28.4.1	Registering an OpenSSO Agent using the Oracle Access Management Console..	28-27
28.4.2	Configuring and Managing Registered OpenSSO Agents Using the Console	28-28
28.5	Performing Remote Registration for OpenSSO Agents	28-29
28.5.1	Request Templates for OpenSSO Agent Remote Registration	28-30
28.5.2	OpenSSO Bootstrap Configuration Mappings.....	28-32
28.5.3	Performing In-Band Remote Registration with OpenSSO Agents.....	28-34
28.5.4	Performing Out-of-Band Remote Registration with OpenSSO Agents	28-35
28.6	Open SSO Remote Registration versus Remote Updates	28-36
28.6.1	Updating OpenSSO Agents Remotely	28-36

28.7	Other OpenSSO Agent Information in this Guide.....	28-37
29	Registering and Managing Legacy OSSO Agents	
29.1	Understanding OSSO Agents with Access Manager	29-1
29.1.1	About OSSO Agents with Access Manager.....	29-1
29.1.2	Comparing Access Manager 11g SSO versus OSSO 10g.....	29-2
29.2	Registering OSSO Agents Using Oracle Access Management Console	29-7
29.2.1	Understanding the Create OSSO Agent Registration Page and Parameters.....	29-7
29.2.2	Registering an OSSO Agent (mod_osso) Using the Console	29-9
29.3	Configuring and Managing Registered OSSO Agents Using the Console	29-10
29.3.1	About the Expanded OSSO Agent Page in the Console.....	29-10
29.3.2	Searching for an OSSO Agent (mod_osso) Registration	29-11
29.3.3	Viewing or Editing OSSO Agent (mod_osso) Registration.....	29-12
29.3.4	Deleting an OSSO Agent (mod_osso) Registration.....	29-13
29.4	Performing Remote Registration for OSSO Agents.....	29-13
29.4.1	About Request Templates for OSSO Remote Registration	29-14
29.4.2	Performing In-Band Remote Registration of OSSO Agents.....	29-15
29.4.3	Performing Out-of-Band Remote Registration for OSSO Agents	29-16
29.5	Updating Registered OSSO Agents Remotely.....	29-17
29.6	Configuring Logout for OSSO Agents with Access Manager 11.1.2.....	29-19
29.6.1	About Centralized Logout with OSSO Agents (mod_OSSO) and Access Manager	29-19
29.6.2	Removing Custom mod_osso Cookies on Logout	29-19
29.7	Locating Other OSSO Agent Information	29-20
30	Registering and Managing 10g WebGates with Access Manager 11g	
30.1	Prerequisites for Registering and Managing 10g WebGates with Access Manager 11g....	30-1
30.2	Introduction to 10g OAM Agents for Access Manager 11g	30-2
30.2.1	About IAMSuiteAgent: A Pre-Configured 10g WebGate Registered with Access Manager	30-2
30.2.2	About Legacy Oracle Access Manager 10g Deployments and WebGates.....	30-2
30.2.3	About Installing Fresh 10g WebGates to Use With Access Manager 11.1.2	30-3
30.2.4	About Centralized Logout with 10g OAM Agents and 11g OAM Servers	30-5
30.3	Comparing Access Manager 11.1.2 and 10g	30-5
30.3.1	Comparing Access Manager 11g versus 10g.....	30-5
30.3.2	Comparing Access Manager 11g versus 10g Policy Model	30-8
30.4	Configuring Centralized Logout for IAMSuiteAgent	30-12
30.5	Registering a 10g WebGate with Access Manager 11g Remotely	30-13
30.6	Managing 10g OAM Agents Remotely	30-15
30.7	Locating and Installing the Latest 10g WebGate for Access Manager 11g	30-16
30.7.1	Preparing for a Fresh 10g WebGate Installation with Access Manager 11g.....	30-16
30.7.2	Locating and Downloading 10g WebGates for Use with Access Manager 11g.....	30-19
30.7.3	Starting WebGate 10g Installation	30-19
30.7.4	Specifying a Transport Security Mode	30-20

30.7.5	Requesting or Installing Certificates for Secure Communications	30-20
30.7.6	Specifying WebGate Configuration Details	30-21
30.7.7	Updating the WebGate Web Server Configuration	30-22
30.7.8	Finishing WebGate Installation.....	30-23
30.7.9	Installing Artifacts and Certificates	30-24
30.7.10	Confirming WebGate Installation.....	30-25
30.8	Configuring Centralized Logout for 10g WebGate with 11g OAM Servers.....	30-25
30.8.1	About Centralized Logout Processing for 10g WebGate with 11g OAM Server...	30-26
30.8.2	Centralized Logout Script for 10g WebGates with 11g OAM Servers	30-27
30.8.3	Configuring Centralized Logout for 10g WebGates with Access Manager	30-29
30.9	Removing a 10g WebGate from the Access Manager 11g Deployment.....	30-30

31 Configuring Apache, OHS, IHS for 10g WebGates

31.1	Prerequisites for Configuring Apache, OHS, IHS for 10g WebGates	31-1
31.2	About Oracle HTTP Server and Access Manager.....	31-1
31.3	About Access Manager with Apache and IHS v2 Webgates.....	31-2
31.3.1	About the Apache HTTP Server.....	31-3
31.3.2	About the IBM HTTP Server.....	31-3
31.3.3	About the Apache and IBM HTTP Reverse Proxy Server.....	31-3
31.4	About Apache v2 Architecture and Access Manager.....	31-4
31.4.1	Requirements or Webgates Installed with IHS and Apache v2	31-5
31.4.2	Limitations of Apache and IHS v2 Web Servers.....	31-5
31.5	Requirements for Oracle HTTP Server, IHS, Apache v2 Web Servers	31-6
31.5.1	Requirements for IHS2 Web Servers	31-6
31.5.2	Requirements for Apache and IHS v2 Reverse Proxy Servers	31-6
31.5.3	Requirements for Apache v2 Web Servers	31-7
31.6	Preparing Your Web Server	31-8
31.6.1	Preparing the IHS v2 Web Server	31-9
31.6.2	Preparing Apache and Oracle HTTP Server Web Servers on Linux	31-12
31.6.3	Preparing Oracle HTTP Server Web Servers on Linux and Windows Platforms ..	31-12
31.6.4	Setting Oracle HTTP Server Client Certificates	31-13
31.6.5	Preparing the Apache v2 Web Server on UNIX.....	31-13
31.6.6	Preparing the Apache v2 SSL Web Server on AIX.....	31-17
31.6.7	Apache v2 Installation on Windows versus Installation on UNIX.....	31-18
31.6.8	Preparing Apache v2 for Windows	31-20
31.7	Activating Reverse Proxy for Apache v2 and IHS v2.....	31-20
31.7.1	Activating Reverse Proxy For Apache v2 Web Servers.....	31-21
31.7.2	Activating Reverse Proxy For IHS v2 Web Servers.....	31-21
31.8	Verifying httpd.conf Updates for Webgates.....	31-23
31.8.1	Verifying Webgate Details	31-24
31.8.2	Verifying Language Encoding.....	31-26
31.9	Tuning Oracle HTTP Server Webgates for Access Manager.....	31-26
31.10	Tuning OHS /Apache Prefork and Worker MPM Modules for OAM.....	31-27

31.10.1	Oracle HTTP Server / Apache Prefork MPM Module Parameters	31-28
31.10.2	Oracle HTTP Server / Apache Worker MPM Module Parameters	31-28
31.10.3	Kernel Parameters	31-29
31.11	Starting and Stopping Oracle HTTP Server Web Servers	31-29
31.12	Tuning Apache/IHS v2 Webgates for Access Manager	31-29
31.12.1	About Apache v2 bundled with Security-Enhanced Linux	31-30
31.12.2	About Apache v2 bundled SELinux-enabled Linux Distribution.....	31-30
31.12.3	Apache v2 Directives	31-31
31.13	Removing Web Server Configuration Changes After Uninstall.....	31-32
31.14	Helpful Information about Building an Apache Release and Source Code.....	31-32

32 Configuring the ISA Server for 10g WebGates

32.1	Prerequisites for Configuring the ISA Server for 10g WebGates.....	32-1
32.2	About Access Manager and the ISA Server	32-1
32.3	Compatibility and Platform Support	32-2
32.4	Installing and Configuring Webgate for the ISA Server	32-2
32.4.1	Installing Webgate with ISA Server.....	32-3
32.4.2	Changing /access Directory Permissions	32-3
32.5	Configuring the ISA Server for the ISAPI Webgate.....	32-3
32.5.1	Registering Access Manager Plug-ins as ISA Server Web Filters	32-4
32.5.2	Configuring ISA Firewall Policies for ISA Web Filters.....	32-5
32.5.3	Ordering the ISAPI Filters.....	32-7
32.6	Starting, Stopping, and Restarting the ISA Server	32-7
32.7	Removing Access Manager Filters Before Webgate Uninstall on ISA Server.....	32-8

33 Configuring the IIS Web Server for 10g WebGates

33.1	Prerequisites for Configuring the IIS Web Server for 10g WebGates	33-1
33.2	About WebGate Guidelines for IIS Web Servers	33-1
33.2.1	About Guidelines for ISAPI WebGates	33-2
33.3	Prerequisites for Installing Webgate for IIS 7	33-6
33.3.1	Prerequisites for Installing Any 10g Webgate for IIS 7.....	33-6
33.3.2	Prerequisite for Installing a 32-bit Webgate for IIS 7	33-6
33.3.3	Adding the IIS 6 Management Compatibility Module for a 32-bit Webgate for IIS and Simple or Cert Security	33-7
33.4	Updating IIS 7 Web Server Configuration on Windows 2008	33-7
33.5	Completing Webgate Installation with IIS.....	33-7
33.5.1	Enabling Client Certificate Authentication on the IIS Web Server	33-8
33.5.2	Ordering the ISAPI Filters.....	33-9
33.5.3	Enabling Pass-Through Functionality for POST Data	33-10
33.5.4	Protecting a Web Site When the Default Site is Not Setup	33-15
33.6	Installing and Configuring Multiple 10g WebGates for a Single IIS 7 Instance.....	33-15
33.6.1	Installing Each IIS 7 Webgate in a Multiple Webgate Scenario.....	33-16
33.6.2	Setting the Impersonation DLL for Multiple IIS 7 Webgates.....	33-18

33.6.3	Enabling Client Certification for Multiple IIS 7 Webgates.....	33-19
33.6.4	Configuring IIS 7 Webgates for Pass Through Functionality	33-20
33.6.5	Confirming IIS 7 Webgate Installation.....	33-21
33.7	Installing and Configuring Multiple Webgates for a Single IIS 6 Instance	33-22
33.7.1	Installing Each Webgate in a Multiple Webgate Scenario.....	33-23
33.7.2	Setting the Impersonation DLL for Multiple Webgates	33-25
33.7.3	Enabling SSL and Client Certification for Multiple Webgates	33-26
33.7.4	Confirming Multiple Webgate Installation	33-27
33.8	Finishing 64-bit Webgate Installation	33-27
33.8.1	Setting Access Permissions, ISAPI filters, and Directory Security Authentication	33-28
33.8.2	Setting Client Certificate Authentication.....	33-29
33.9	Confirming Webgate Installation on IIS.....	33-29
33.10	About Starting, Stopping, and Restarting the IIS Web Server	33-30
33.11	Removing Web Server Configuration Changes Before Uninstall.....	33-30

34 Configuring Lotus Domino Web Servers for 10g WebGates

34.1	Prerequisites for Configuring Lotus Domino Web Servers for 10g WebGates	34-1
34.2	Installing the Domino Web Server	34-1
34.3	Setting Up the First Domino Web Server	34-3
34.4	Starting the Domino Web Server.....	34-3
34.5	Enabling SSL by Generating a Keyring and a Stash File.....	34-4
34.6	Installing a Domino Security (DSAPI) Filter	34-5
34.6.1	Completing the WebGate Installation.....	34-5

Part VIII Managing the Adaptive Authentication Service and Oracle Mobile Authenticator

35 Introducing the Adaptive Authentication Service

35.1	About Adaptive Authentication Service	35-1
35.2	Working with the Adaptive Authentication Service	35-2
35.2.1	Understanding the One Time Password Option	35-3
35.2.2	Understanding the Access Request (Push) Notification Option	35-5
35.2.3	Using the Oracle Mobile Authenticator with OTP And Access Request.....	35-7
35.3	Understanding Adaptive Authentication Service and OMA Configurations	35-7
35.4	Configuring an Adaptive Authentication Service	35-7
35.4.1	Generating a Secret Key for the Oracle Mobile Authenticator	35-8
35.4.2	Configuring Mobile OAuth Services to Protect a Secret Key	35-8
35.4.3	Configuring the Adaptive Authentication Plug-in in the Oracle Access Management Console.....	35-8
35.4.4	Setting Credentials for UMS, iOS, and Android.....	35-10
35.4.5	Creating a Java KeyStore for iOS Access Request (Push) Notifications.....	35-12
35.4.6	Configuring Host Name Verifier for Android Access Request (Push) Notifications	35-13

35.4.7	Configuring Access Manager for VPN in a Use Case	35-13
--------	--	-------

36 Configuring the Oracle Mobile Authenticator

36.1	Understanding Oracle Mobile Authenticator Configuration.....	36-1
36.2	Using the Oracle Mobile Authenticator App on iOS.....	36-3
36.2.1	Configuring the Oracle Mobile Authenticator for iOS	36-4
36.2.2	Initializing the Oracle Mobile Authenticator on iOS	36-4
36.2.3	Copying a One-Time Password from the Oracle Mobile Authenticator on iOS.....	36-6
36.2.4	Editing an Account on the Oracle Mobile Authenticator on iOS.....	36-6
36.2.5	Deleting an Account on the Oracle Mobile Authenticator on iOS.....	36-7
36.2.6	Responding to Access Request (Push) Notifications on iOS.....	36-7
36.2.7	Displaying Access Request (Push) Notifications History on iOS	36-7
36.2.8	Displaying Service Account Details on iOS.....	36-7
36.2.9	Displaying Access Manager Registered Accounts on iOS	36-8
36.2.10	Displaying the OMA Version on iOS	36-8
36.3	Using the Oracle Mobile Authenticator App on Android.....	36-8
36.3.1	Configuring the Oracle Mobile Authenticator for Android.....	36-9
36.3.2	Initializing the Oracle Mobile Authenticator on Android.....	36-9
36.3.3	Copying a One-Time Password from the Oracle Mobile Authenticator on Android	36-11
36.3.4	Editing an Account on the Oracle Mobile Authenticator on Android	36-11
36.3.5	Deleting an Account on the Oracle Mobile Authenticator on Android	36-11
36.3.6	Responding to Access Request (Push) Notifications on Android.....	36-12
36.3.7	Displaying Access Request (Push) Notifications History on Android.....	36-12
36.3.8	Displaying Service Account Details on Android.....	36-12
36.3.9	Displaying Access Manager Registered Accounts on Android	36-12
36.3.10	Displaying the OMA Version on Android	36-13
36.4	Configuring the Google Authenticator App.....	36-13
36.5	Using a QR Code for Configuration	36-13

Part IX Managing Oracle Access Management Identity Federation

37 Introducing Identity Federation in Oracle Access Management

37.1	Integrating Identity Federation with Access Manager.....	37-1
37.2	Deploying Identity Federation with Oracle Access Management	37-2
37.3	Understanding How Identity Federation Works.....	37-3
37.4	Using Identity Federation.....	37-3
37.4.1	Achieving SSO	37-4
37.4.2	Logging Out	37-4
37.4.3	Authorizing	37-4
37.4.4	Forcing Authentication.....	37-5
37.4.5	Indicating a Passive Identity Provider	37-5
37.4.6	User and Assertion Mapping	37-5

37.4.7	Platform Dependencies	37-5
37.5	Initiating Federation SSO.....	37-5
37.5.1	IdP Initiated Federation SSO Service.....	37-6
37.5.2	SP Initiated Federation SSO Service	37-7
37.5.3	Attribute Consuming Service	37-7
37.6	Exchanging Identity Federation Data	37-16
37.6.1	Using SAML 2.0.....	37-16
37.6.2	Using SAML 1.1.....	37-20
37.6.3	Using OpenID 2.0	37-22
37.6.4	Using WS-Federation 1.1.....	37-24
37.7	Administrating Identity Federation.....	37-25
37.8	Enabling Identity Federation	37-26

38 Managing Identity Federation Partners

38.1	Understanding Federation And Partners.....	38-1
38.2	Managing Federation Partners	38-2
38.3	Administering Identity Federation As A Service Provider	38-2
38.3.1	Creating Remote Identity Provider Partners.....	38-3
38.3.2	Managing the Remote Identity Provider Partners	38-10
38.4	Administering Identity Federation As An Identity Provider	38-11
38.4.1	Creating Remote Service Provider Partners.....	38-12
38.4.2	Managing the Remote Service Provider Partners.....	38-13
38.5	Using Attribute Mapping Profiles.....	38-14
38.5.1	Using the SP Attribute Mapping Profile.....	38-15
38.5.2	Using the IdP Attribute Mapping Profile	38-17
38.6	Mapping Federation Authentication Methods to Access Manager Authentication Schemes	38-18
38.6.1	Understanding Federation SSO As An IdP	38-19
38.6.2	Understanding Federation SSO As An SP	38-20
38.6.3	Configuring an Alternate Authentication Scheme	38-20
38.6.4	Using WLST For Mapping Administration.....	38-21
38.7	Using the Attribute Sharing Plug-in for the Attribute Query Service	38-21
38.7.1	Understanding the Plug-in and Query Service Design	38-22
38.7.2	Configuring for Attribute Sharing	38-25
38.8	Using the Federation Proxy	38-29
38.9	Using WLST for Identity Federation Administration	38-29

39 Managing Settings for Identity Federation

39.1	Prerequisites for Settings in Federation Identity.....	39-1
39.2	About Federation Settings.....	39-1
39.3	Managing General Federation Settings	39-2
39.3.1	About Managing General Federation Settings.....	39-2
39.3.2	Managing General Federation Settings.....	39-3

39.4	Managing Proxy Settings for Federation.....	39-3
39.4.1	About Proxy Settings for Federation	39-4
39.4.2	Managing Proxy Settings for Identity Federation	39-4
39.5	Defining Keystore Settings for Federation.....	39-5
39.5.1	About Managing Keystore Settings for Identity Federation	39-5
39.5.2	Managing Identity Federation Encryption/Signing Keys	39-5
39.6	Exporting Metadata.....	39-8

40 Managing Federation Schemes and Policies

40.1	Use of Identity Federation and Access Manager Together	40-1
40.2	Using Authentication Schemes and Modules for Identity Federation 11g Release 2 (11.1.2.2).....	40-2
40.2.1	About the FederationScheme Authentication Scheme	40-2
40.2.2	About the FederationMTScheme	40-3
40.2.3	About the FederationPlugin Authentication Module.....	40-3
40.2.4	Managing Authentication with Identity Federation in 11g Release 2.....	40-5
40.3	Using Authentication Schemes and Modules for Oracle Identity Federation 11g Release 1	40-7
40.3.1	About Scheme OIFScheme.....	40-8
40.3.2	About the OIFMTLDAPPlugin Authentication Module.....	40-9
40.3.3	Managing Authentication with Oracle Identity Federation Release 11gR1	40-9
40.4	Managing Access Manager Policies for Use with Identity Federation.....	40-11
40.4.1	About Policy Responses with Assertion Attributes for Identity Federation.....	40-11
40.4.2	Defining Policy Responses with Assertion Attributes for Identity Federation.....	40-12
40.5	Testing Identity Federation Configuration	40-14
40.5.1	Test SP Module	40-14
40.5.2	Accessing the Test SP Module and Performing a Federation SSO Operation	40-14
40.5.3	Troubleshooting Errors During Federation Configuration After an Upgrade	40-15
40.6	Using the Default Identity Provisioning Plug-in	40-15
40.6.1	Why Use a Provisioning Plug-in?	40-15
40.6.2	About the Default Provisioning Plug-in	40-16
40.6.3	Using the Default Provisioning Plug-in.....	40-16
40.6.4	Switching to a Custom Provisioning Plug-in	40-16
40.7	Configuring the Identity Provider Discovery Service.....	40-16
40.7.1	Configuring the Bundled IdP Discovery Service.....	40-17
40.7.2	Configuring Identity Federation with a Custom IdP Discovery Service	40-17
40.7.3	Disabling the use of an IdP Discovery Service.....	40-19
40.8	Configuring the Federation User Self-Registration Module	40-20
40.8.1	Enabling or Disabling a User Self Registration Module	40-20
40.8.2	Configuring User Registration Properties	40-21
40.9	Integrating OAM Identity Provider With Microsoft Office 365 Service Provider	40-22
40.9.1	Configuring Microsoft Office 365 for OAM Integration.....	40-23
40.9.2	Configuring OAM for Microsoft Office 365 Integration.....	40-24

40.9.3	Verifying Federation Single Sign-On.....	40-25
--------	--	-------

Part X Managing Oracle Access Management Security Token Service

41 Introducing the Oracle Access Management Security Token Service

41.1	About the Security Token Service	41-1
41.2	Using the Security Token Service	41-2
41.3	About Security Token Service Key Terms and Concepts	41-3
41.4	Integrating the Oracle Web Services Manager	41-7
41.5	About the Architecture of the Security Token Service	41-9
41.6	Security Token Service Supported Token Matrix	41-9
41.7	Deploying Security Token Service	41-10
41.7.1	About the Centralized Token Authority Deployment.....	41-10
41.7.2	About Tokens Behind a Firewall Deployment.....	41-11
41.7.3	About Web Services SSO Deployment.....	41-12
41.8	About the Installation of the Security Token Service	41-12
41.8.1	About Security Token Service Cluster in Single WLS Domain	41-12
41.8.2	About Endpoint Exposure through a Web Server Proxy	41-13
41.8.3	About Interoperability of Requester and Relying Party with Other Oracle WS-Trust based Clients	41-13
41.8.4	About Security Token Service Installation Overview	41-13
41.8.5	Post-Installation Tasks: Security Token Service	41-14
41.9	Administrating the Security Token Service	41-14

42 Security Token Service Implementation Scenarios

42.1	Typical Token Ecosystem	42-1
42.1.1	Actors and Process Overview: In a typical token ecosystem.....	42-2
42.2	Scenario: Identity Propagation with the Access Manager Token.....	42-2
42.2.1	Actors and Process Overview: Identity Propagation.....	42-3
42.2.2	About Component Processing: Identity Propagation with the OAM Token	42-4
42.2.3	Request Security Token Attributes and Run Time Processing.....	42-6
42.2.4	Configuration Requirements: Identity Propagation with the OAM Token.....	42-8
42.2.5	Testing Your Implementation.....	42-15
42.3	Scenario: Web Service Security On Behalf Of Username Token	42-16
42.3.1	Component interactions for Identity Propagation with Username Token.....	42-16
42.3.2	RST Attributes and Processing for Identity Propagation with a Username Token	42-17
42.3.3	Configuration Requirements: Identity Propagation with the Username Token....	42-19

43 Configuring Security Token Service Settings

43.1	Prerequisites for the Configuration of Security Token Service Settings.....	43-1
43.2	Introduction to Security Token Service Configuration	43-1
43.2.1	Post-Installation Configuration	43-2
43.2.2	About OAM Servers and Security Token Service.....	43-3

43.2.3	About Security Token Service Clients	43-4
43.2.4	About Agents and Security Token Service	43-4
43.2.5	About Security Token Service End Points and Policies	43-5
43.3	Enabling and Disabling Security Token Service	43-8
43.3.1	About Security Token Service and the Oracle Access Management Console	43-8
43.3.2	About Enabling Services for Security Token Service	43-9
43.3.3	Enabling and Disabling Services for Security Token Service	43-9
43.4	Defining Security Token Service Settings	43-10
43.4.1	About Security Token Service Settings	43-10
43.4.2	Managing Security Token Service Settings.....	43-12
43.5	Using and Managing WSS Policies for Oracle WSM Agents	43-13
43.5.1	Using and Modifying Oracle Workspace Studio Policies	43-13
43.5.2	Managing WSS Policies for Security Token Service: Classpath	43-14
43.5.3	Managing WSS Policies for Security Token Service: Oracle WSM Policy Manager	43-14
43.6	Configuring OWSM for WSS Protocol Communication.....	43-15
43.6.1	Task Overview: Configuring Communication with Oracle WSM Agents	43-16
43.6.2	About Oracle WSM Agent WS-Security Policies for Security Token Service.....	43-16
43.6.3	Retrieving the Oracle WSM Keystore Password	43-16
43.6.4	Extracting the Oracle STS/Oracle WSM Signing and Encryption Certificate.....	43-17
43.6.5	Adding Trusted Certificates to the Oracle WSM Keystore	43-18
43.6.6	Validating Trusted Certificates in the Oracle WSM Keystore	43-18
43.6.7	Configuring Oracle WSM Agent for WSS Kerberos Policies	43-19
43.7	Managing and Migrating Security Token Service Policies	43-20
43.7.1	About Managing and Migrating Security Token Service Policies	43-20
43.7.2	Managing Security Token Service Policies	43-21
43.7.3	Migrating Security Token Service Policies	43-21
43.8	Logging Security Token Service Messages	43-21
43.9	Auditing the Security Token Service	43-22
43.9.1	About Security Token Service Audit Record Storage	43-23
43.9.2	About Audit Reports and Oracle Business Intelligence Publisher	43-24
43.9.3	About the Audit Log.....	43-24
43.9.4	About Auditing Security Token Service Events	43-24

44 Managing Security Token Service Certificates and Keys

44.1	Prerequisites for Managing Security Token Service Certificates and Keys	44-1
44.2	Introduction to Security Token Service Certificates and Keys.....	44-1
44.2.1	About Keystores and Security Token Service	44-2
44.2.2	About the Oracle Web Services Manager Keystore (default-keystore.jks).....	44-3
44.2.3	About Using the OPSS Keystore for Requester Certificates	44-4
44.3	Managing Security Token Service Encryption and Signing Keys	44-4
44.3.1	Task Overview: Managing Security Token Service Encryption/Signing Keys	44-4
44.3.2	Resetting System Keystore (.oamkeystore) and Trust Keystore (amtruststore) Password.....	44-4

44.3.3	Adding a New Key Entry to the System Keystore (.oamkeystore).....	44-5
44.3.4	Extracting an Security Token Service Certificate.....	44-7
44.4	Managing Partner Keys for WS-Trust Communications.....	44-7
44.4.1	About Partner Certificates.....	44-8
44.4.2	About Downloading the Relying Party's Certificate at Run Time.....	44-8
44.4.3	Setting the Partner's Signing or Encryption Certificate.....	44-9
44.5	Managing Certificate Validation.....	44-9
44.5.1	Managing the Trust Anchors Store (amtruststore).....	44-10
44.5.2	Managing Certificate Revocation Lists.....	44-11
44.5.3	Using a Custom Trust Anchor Store for Security Token Service.....	44-11

45 Managing Templates, Endpoints, and Policies

45.1	Introduction.....	45-1
45.2	Searching for an Existing Template.....	45-2
45.2.1	About Template Search Controls.....	45-3
45.2.2	Searching For a Template.....	45-5
45.3	Managing Token Issuance Templates.....	45-5
45.3.1	About Managing Token Issuance Templates.....	45-5
45.3.2	Managing a Token Issuance Template.....	45-14
45.4	Managing Token Validation Templates.....	45-15
45.4.1	About Managing Token Validation Templates.....	45-15
45.4.2	Managing Token Validation Templates.....	45-29
45.5	Managing Security Token Service Endpoints.....	45-31
45.5.1	About Managing Endpoints.....	45-31
45.5.2	Managing EndPoints.....	45-32
45.6	Managing Token Issuance Policies, Conditions, and Rules.....	45-33
45.6.1	About Token Issuance Policies.....	45-33
45.6.2	About Managing Token Issuance Conditions and Rules.....	45-33
45.6.3	Managing Token Issuance Policies and Conditions.....	45-35
45.7	Managing TokenServiceRP Type Resources.....	45-37
45.7.1	About Managing TokenServiceRP Type Resources in Access Manager.....	45-38
45.7.2	Managing TokenServiceRP Type Resources in Application Domains.....	45-39
45.8	Making Custom Classes Available.....	45-39
45.8.1	About Making Classes Available.....	45-40
45.8.2	About Narrowing a Search for Custom Tokens.....	45-42
45.8.3	Managing Custom Tokens.....	45-44
45.9	Managing a Custom Security Token Service Configuration.....	45-45
45.9.1	Creating a Validation Template.....	45-46
45.9.2	Creating the Issuance Template for a Custom Token.....	45-47
45.9.3	Adding the Custom Token to a Requester Profile.....	45-49
45.9.4	Adding a Custom Token to a Relying Party Profile.....	45-50
45.9.5	Mapping the Token to a Requestor.....	45-51
45.9.6	Creating an /wssuser EndPoint.....	45-51

46 Managing Token Service Partners and Partner Profiles

46.1 Prerequisites to Using Token Service Partners and Partner Profiles	46-1
46.2 Introduction to Token Service Partners and Partner Profiles	46-1
46.2.1 About Token Service Partners	46-1
46.2.2 About Security Token Service Partner Profiles	46-2
46.3 Managing Token Service Partners	46-3
46.3.1 New Requester Partner Page	46-3
46.3.2 Managing a Token Service Partner	46-6
46.3.3 Refining Partner Searches	46-8
46.4 Managing Token Service Partner Profiles	46-8
46.4.1 About Managing Partner Profiles	46-8
46.4.2 Managing a Token Service Partner Profile	46-20
46.4.3 Refining a Profile Search	46-22

47 Troubleshooting Security Token Service

47.1 Authorization Issues	47-1
47.2 Endpoint Issues	47-2
47.3 Mapping Operation Issues	47-3

Part XI Managing Oracle Access Management Mobile and Social

48 Understanding Mobile and Social

48.1 Introducing Mobile and Social	48-1
48.1.1 Installation Combinations for Mobile and Social	48-3
48.1.2 Deployment Constraints for Mobile and Social	48-4
48.1.3 Enabling Mobile and Social	48-5
48.2 Understanding Mobile and Social Services	48-5
48.2.1 Mobile and Social Components	48-6
48.2.2 Introducing Authentication Services and Authorization Services	48-6
48.2.3 Understanding the Mobile and Social Services Authorization Flow	48-8
48.2.4 Understanding Single Sign-on (SSO) for Mobile and Social Services	48-8
48.2.5 Introducing the Mobile and Social Services Client SDK	48-10
48.2.6 Introducing User Profile Services	48-10
48.3 Understanding the Mobile and Social Services Processes	48-11
48.3.1 Registration Flow for a Mobile Device With User Authentication	48-12
48.3.2 Authentication Flow for a User With a Registered Device	48-15
48.3.3 Flow of REST Calls for User Authentication	48-17
48.3.4 Authentication Flow for User With a Mobile Browser-Based Web App	48-18
48.3.5 Authorization Using the Mobile OAuth Authorization Flow	48-19
48.4 Using Mobile and Social Services	48-21
48.4.1 Protecting the Mobile Client Registration Endpoint	48-21
48.4.2 Token Requirements for Mobile and Social Server	48-22

48.4.3	Protecting User Profile Services And Authorization Services.....	48-23
48.4.4	How Mobile and Social Services Work with Oracle Access Manager.....	48-24
48.4.5	How Mobile and Social Services Work with Oracle Adaptive Access Manager Services.....	48-24
48.5	Understanding Social Identity	48-24
48.6	Understanding Social Identity Processes	48-25
48.6.1	Basic Flow for Social Identity Authentication.....	48-26
48.6.2	Authentication Flow for a Returning User With a Local Account.....	48-26
48.6.3	Authentication Flow for a New User With No Local Account.....	48-28
48.6.4	OAuth Flow For Access Token Retrieval.....	48-29
48.6.5	Authentication Flow for a User With Access Manager and Social Identity	48-31
48.6.6	Authentication Flow for a Local User	48-33
48.7	Using Social Identity	48-34
48.7.1	How Social Identity Works with Oracle Access Manager	48-34
48.7.2	How Social Identity Works with Mobile and Social Services.....	48-34
48.7.3	About the Social Identity SDK.....	48-35

49 Configuring Mobile and Social Services

49.1	Opening the Mobile and Social Services Configuration Page.....	49-1
49.2	About Mobile and Social Services Configuration	49-2
49.2.1	Service Providers.....	49-2
49.2.2	Service Profiles.....	49-3
49.2.3	Security Handler Plug-ins.....	49-3
49.2.4	Application Profiles	49-4
49.2.5	Service Domains	49-4
49.3	Defining Service Providers.....	49-5
49.3.1	Defining, Modifying or Deleting an Authentication Service Provider	49-5
49.3.2	Defining, Modifying or Deleting an Authorization Service Provider	49-19
49.3.3	Defining, Modifying or Deleting a User Profile Service Provider	49-21
49.4	Defining Service Profiles.....	49-25
49.4.1	Defining, Modifying, and Deleting an Authentication Service Profile	49-26
49.4.2	Defining, Modifying and Deleting an Authorization Service Profile.....	49-27
49.4.3	Defining, Modifying and Deleting a User Profile Service Profile	49-29
49.5	Defining Security Handler Plug-ins.....	49-30
49.5.1	Creating a Security Handler Plug-in	49-30
49.5.2	Editing or Deleting a Security Handler Plug-in.....	49-31
49.5.3	Device Fingerprinting and Device Profile Attributes	49-31
49.6	Defining Application Profiles	49-32
49.6.1	Creating an Application Profile	49-32
49.6.2	Editing or Deleting an Application Profile.....	49-33
49.6.3	Application Profile Properties	49-33
49.7	Defining Service Domains	49-35
49.7.1	Creating a Service Domain.....	49-35

49.7.2	Editing or Deleting a Service Domain	49-39
49.8	Using the Jailbreak Detection Policy	49-39
49.8.1	Creating a New Jailbreak Detection Policy with the Oracle Access Management Console	49-40
49.8.2	Editing a Jailbreak Detection Policy	49-41
49.9	Configuring Mobile and Social Services with Other Oracle Products	49-41
49.9.1	Configuring Mobile and Social Services for Access Manager	49-42
49.9.2	Configuring Mobile and Social Services for Oracle Adaptive Access Manager	49-48
50	Configuring Social Identity	
50.1	Opening the Manage Social Identity Page	50-1
50.2	Understanding Social Identity Configuration	50-2
50.2.1	Social Identity Providers	50-2
50.2.2	Service Provider Interfaces	50-2
50.2.3	Application Profiles	50-3
50.3	Defining Social Identity Providers	50-3
50.3.1	Creating a Social Identity Provider.....	50-3
50.3.2	Editing or Deleting a Social Identity Provider	50-9
50.3.3	Generating the Consumer Key and Consumer Secret for OAuth Providers.....	50-9
50.3.4	Troubleshooting Facebook Social Identity Providers	50-12
50.4	Defining Service Provider Interfaces	50-13
50.4.1	Creating a Service Provider Interface.....	50-13
50.4.2	Editing or Deleting an Service Provider Interface.....	50-14
50.4.3	Adding a Custom Service Provider Interface Implementation	50-14
50.5	Defining Application Profiles	50-14
50.5.1	Creating an Application Profile	50-15
50.5.2	Editing or Deleting an Application Profile.....	50-19
50.6	Integrating Social Identity With Mobile Applications	50-19
50.7	Linking Social Identity Provider Accounts.....	50-20
50.7.1	Social Identity Provider Account Linking Flow	50-20
50.7.2	Social Identity Provider Account Linking Configuration	50-22
51	Configuring Social Identity System Settings	
51.1	Accessing the Social Identity Settings Interface	51-1
51.1.1	Social Identity Settings Page	51-1
51.2	Logging and Auditing.....	51-2
51.3	Deploying Mobile and Social With Oracle Access Manager	51-2
51.4	Configuring a Webgate to Support Social Identity.....	51-4
51.5	Configuring Social Identity After Running Test-to-Production Scripts	51-6
51.6	Configuring Social Identity for High Availability (HA)	51-7
51.7	Enabling the REST Client to Specify a Tenant Name	51-7

Part XII Managing the Oracle Access Management OAuth Service

52 Understanding OAuth Services

52.1	About Oracle Access Management OAuth Services	52-1
52.2	Understanding OAuth Services Authorization for Web Clients	52-2
52.2.1	Understanding 3-Legged Authorization	52-3
52.2.2	Understanding 2-Legged Authorization	52-5
52.3	Understanding OAuth Services Authorization for Mobile Clients.....	52-5
52.4	Understanding the OAuth Services Components	52-9
52.4.1	Identity Domains - Identity Federation and OAuth Services.....	52-9
52.4.2	Service Profiles - Identity Federation and OAuth Services.....	52-10
52.4.3	Clients - Identity Federation and OAuth Services.....	52-10
52.4.4	Service Providers - Identity Federation and OAuth Services.....	52-12
52.4.5	Resource Servers - Identity Federation and OAuth Services.....	52-12
52.4.6	Plug-Ins - Identity Federation and OAuth Services	52-17
52.4.7	Server Settings - Identity Federation and OAuth Services.....	52-18
52.4.8	Jailbreak Detection Policy - OAuth Services	52-18
52.4.9	Token Life Cycle Management - Identity Federation and OAuth Services.....	52-18
52.5	About OAuth Services Tokens.....	52-18
52.5.1	OAuth Services Access Tokens	52-19
52.5.2	OAuth Services Refresh Tokens	52-20
52.5.3	Mobile OAuth Services Client Tokens	52-20
52.6	Understanding the Authorization and Authentication Endpoints	52-20
52.7	Enforcing Access Control	52-21
52.8	Understanding Mobile OAuth Services Server-Side Single Sign-on	52-22
52.8.1	Understanding the Server-Side Single Sign-On Credential Collection Options ...	52-22
52.8.2	Understanding Server-Side SSO For Mobile OAuth Services 3-Legged Flows	52-23
52.8.3	Understanding Server-Side SSO For Mobile OAuth Services 2-Legged Flows	52-24
52.9	OAuth Services Plug-ins.....	52-25

53 Configuring OAuth Services

53.1	Enabling OAuth Services.....	53-1
53.2	Configuring OAuth Services Components in an Identity Domain.....	53-2
53.3	Configuring OAuth Services Settings.....	53-3
53.3.1	Configuring Identity Domains	53-4
53.3.2	Configuring Service Profiles	53-6
53.3.3	Configuring Clients.....	53-13
53.3.4	Configuring the Service Provider	53-19
53.3.5	Configuring Custom Resource Servers	53-22
53.3.6	Configuring User Profile Services	53-24
53.3.7	Configuring Consent Management Services.....	53-27
53.3.8	Configuring Plug-Ins	53-29

53.3.9	Server Settings.....	53-31
53.3.10	Jailbreak Detection Policy	53-32
53.3.11	Token Life Cycle Management.....	53-33
53.4	Configuring OAuth Services for Third-Party JWT Bearer Assertions	53-34
53.4.1	Default Service Profile Keystore	53-34
53.4.2	Finding Credentials with Oracle Enterprise Manager Fusion Middleware Control Console	53-35
53.4.3	Creating a Non-Default Keystore for a Service Profile.....	53-35
53.4.4	Configuring a Third-Party JWT Trust Issuer	53-39
53.5	Configuring a WebGate to Protect OAuth Services	53-40
53.6	Configuring OAM Session Synchronization	53-42
53.7	Configuring Mobile OAuth for SSO Servlet Authentication	53-43
53.7.1	Configuring OAM and Your App to use the Mobile SSO Servlet	53-44
53.7.2	Configuring the MobileSSOServlet Authentication Scheme	53-45
53.8	Configuring the Mobile Security Manager Plug-in	53-46

Part XIII Managing Oracle Access Management Oracle Access Portal

54 Configuring the Access Portal Service

54.1	Prerequisites for Deploying the Access Portal Service.....	54-1
54.2	Overview of the Access Portal Service Deployment Process	54-2
54.3	Deploying the Access Portal Service.....	54-4
54.3.1	Deploying Java Cryptography Extension Policy Files.....	54-4
54.3.2	Identity Store Configuration File	54-5
54.3.3	Oracle Access Manager Configuration File	54-7
54.3.4	Understanding the Access Portal Service Repository Objects.....	54-11
54.3.5	Preparing and Enabling the Access Portal Service on an Oracle Repository	54-11
54.3.6	Preparing and Enabling the Access Portal Service on Microsoft Active Directory	54-14
54.3.7	(Active Directory Only) Deploying the OAMAgent Web Application.....	54-18
54.3.8	Setting the Policy Cache Refresh Interval.....	54-20
54.3.9	About Integrating with Oracle Privileged Account Manager	54-21
54.3.10	Deploying the Oracle Traffic Director Administration Server	54-24
54.3.11	Deploying Webgate Binaries and Secure Trust Artifacts	54-25
54.3.12	(Optional) Configuring the ESSOProvisioning Plugin	54-26
54.3.13	Creating an Oracle Traffic Director Configuration	54-27
54.3.14	Protecting the Oracle Traffic Director Instance with the Webgate Plugin.....	54-27
54.3.15	(Optional) Enabling the Detached Credential Collector for the Target Webgate	54-29
54.3.16	Configuring Logon Manager for Compatibility with the Access Portal Service	54-31
54.4	Enabling Form-Fill Single Sign-On for an Application	54-33
54.4.1	Configuring a Form-Fill Application Policy.....	54-33
54.4.2	Configuring the OTD EssoDirectSubmit Server Application Function	54-38
54.4.3	Configuring Proxy Rules for an Oracle Access Portal Application	54-39
54.4.4	Configuring the Webgate Request Filtering.....	54-46

54.5	Adding a Federated Partner Provider Application	54-51
54.6	Adding an Oracle SSO Agent Application	54-52
54.7	Creating an Application Configuration Package	54-53
54.7.1	Contents of the Application Configuration Package	54-53
54.7.2	Required Environment-Specific Configuration Data	54-54
54.7.3	Customizing an Application Configuration Package to the Target Environment	54-54
54.7.4	Generating the Customized Application Configuration Package	54-56
54.7.5	Deploying the Customized Application Configuration Package.....	54-57
54.8	Password Generation Policies.....	54-58
54.8.1	Searching for an Existing Password Generation Policy.....	54-58
54.8.2	Creating a New Password Generation Policy	54-58
54.8.3	Managing Policy Subscribers.....	54-61
54.9	Managing Credential Sharing Groups.....	54-62
54.9.1	Searching for a Credential Sharing Groups.....	54-63
54.9.2	Creating a Credential Sharing Group.....	54-64
54.9.3	Managing Applications in Credential Sharing Groups	54-65
54.10	Managing Global Agent Settings.....	54-66
54.10.1	Searching for Sets of Global Agent Settings	54-66
54.10.2	Importing an INI File with a Global Agent Settings Configuration	54-67
54.10.3	Creating a Set of Global Agent Settings	54-67

Part XIV Using Identity Context

55 Using Identity Context

55.1	Introducing Identity Context	55-1
55.2	Understanding Identity Context	55-3
55.3	Working With the Identity Context Service.....	55-4
55.3.1	Identity Context Dictionary	55-4
55.3.2	Identity Context Runtime.....	55-9
55.4	Identity Context API	55-11
55.5	Configuring the Identity Context Service Components.....	55-13
55.5.1	Configuring Oracle Fusion Middleware.....	55-13
55.5.2	Configuring Access Manager	55-14
55.5.3	Configuring Oracle Adaptive Access Manager	55-15
55.5.4	Configuring Web Service Security Manager	55-17
55.5.5	Configuring Oracle Entitlements Server.....	55-17
55.5.6	Configuring Oracle Enterprise Single Sign On	55-18
55.5.7	Configuring Oracle Access Management Mobile and Social.....	55-19
55.6	Validating Identity Context.....	55-21

Part XV Integrating Access Manager with Other Products

56 Integrating RSA SecurID Authentication with Access Manager

56.1	Introduction to Access Manager and RSA SecurID Authentication	56-1
56.2	RSA Features Supported by Access Manager	56-2
56.3	Components Required for SecurID Authentication	56-3
56.3.1	Supported Versions and Platforms.....	56-3
56.3.2	Required RSA Components.....	56-3
56.3.3	Installation and Configuration Requirements	56-4
56.4	SecurID Authentication Modes	56-5
56.4.1	Standard SecurID Authentication.....	56-5
56.4.2	SecurID Next Tokencode Authentication.....	56-6
56.4.3	SecurID New PIN Authentication	56-7
56.5	Configuring Access Manager for RSA SecurID Authentication.....	56-7
56.6	Running a Custom RSA Plug-in.....	56-11

57 Configuring Access Manager for Windows Native Authentication

57.1	Introducing Access Manager with Windows Native Authentication.....	57-1
57.1.1	Understanding Access Manager WNA Login and Fall Back Authentication	57-2
57.1.2	Supported Kerberos Authentication Modules.....	57-5
57.2	About Preparing Your Active Directory and Kerberos Topology	57-5
57.2.1	Preparing Active Directory and Kerberos	57-8
57.3	Confirming Access Manager Operations	57-11
57.4	Enabling the Browser to Return Kerberos Tokens	57-12
57.4.1	Enabling Kerberos Tokens in Internet Explorer	57-12
57.4.2	Enabling Kerberos Tokens in Mozilla Firefox.....	57-12
57.5	Integrating KerberosPlugin with Oracle Virtual Directory	57-13
57.5.1	Preparing Oracle Virtual Directory for Integration.....	57-13
57.5.2	Registering Oracle Virtual Directory as the Default Store for WNA.....	57-14
57.5.3	Setting Up Authentication with Access Manager KerberosPlugin and OVD.....	57-15
57.6	Integrating the KerberosPlugin with Search Failover	57-16
57.6.1	Registering Microsoft Active Directory Instances with Access Manager	57-17
57.6.2	Setting Up the KerberosPlugin for ADGCs.....	57-18
57.7	Configuring Access Manager for Windows Native Authentication.....	57-20
57.7.1	Creating the Authentication Scheme for Windows Native Authentication.....	57-20
57.7.2	Configuring Policies for Windows Native Authentication.....	57-21
57.7.3	Configuring WNA for NTLM Fallback.....	57-21
57.7.4	Configuring WNA Fallback to FORM-based Authentication Scheme.....	57-22
57.7.5	Verifying the Access Manager Configuration File	57-23
57.8	Validating WNA with Access Manager Protected Resources	57-24
57.9	Configuring WNA For Use With DCC.....	57-24
57.9.1	Initializing the Kerberos Protocol	57-25

57.9.2	Configuring Access Manager	57-26
57.10	Troubleshooting WNA Configuration	57-27
57.10.1	Kinit Fails.....	57-27
57.10.2	"An Incorrect Username or Password was Specified" Is Displayed.....	57-28
57.10.3	User Identity Store is Not Registered Correctly	57-28
57.10.4	Two BASIC Authentication Prompts Are Displayed.....	57-28

58 Integrating JBoss with Access Manager

58.1	Overview of JBoss Integration with Access Manager	58-1
58.1.1	Configuration and Processing by the JBoss Agent.....	58-2
58.1.2	Configuration and Processing by the Login Module.....	58-4
58.1.3	Login Module Process in usernamePassword Mode.....	58-5
58.1.4	Login Module Process in tokenBased Mode	58-6
58.2	Understanding the Integration Topology	58-6
58.2.1	Topology: Access Manager with JBoss Agent	58-6
58.2.2	Topology: JBoss Agent Behind Web Server Configured with WebGate.....	58-6
58.2.3	Sample Integration Topology	58-7
58.3	Preparing Your Environment for JBoss 6.x Integration	58-8
58.4	Preparing Your Environment for JBoss 5.x Integration	58-10
58.5	Protecting JBoss-Specific Resources.....	58-11
58.5.1	Registering the JBoss Agent with Automatic Policy Creation.....	58-11
58.5.2	Creating a Custom Policy for JBoss Resource Protection.....	58-13
58.6	Protecting Web Applications with the JBoss Agent	58-14
58.6.1	Creating Configuration Properties for the JBoss Agent	58-14
58.6.2	Configuring the Authentication Valve.....	58-15
58.6.3	Mapping the Filter in the Application's web.xml File	58-16
58.6.4	Configuring the JBoss Login Module to Use Access Manager Policies	58-17
58.7	Configuring JBoss Server to Access a Host Name (not localhost).....	58-17
58.8	Configuring the Login Module to Secure EJBs.....	58-18
58.8.1	Configuring the Server to Secure EJBs	58-18
58.8.2	Configuring the Client Side for Login Module to Secure EJBs.....	58-20
58.9	Configuring the Login Module to Secure Web Service Access.....	58-21
58.9.1	Configuring the Server to Secure Web Services Access.....	58-21
58.9.2	Configuring the Client to Secure Web Services Access	58-22
58.10	Configuring Logging for the JBoss Agent and Login Module.....	58-23
58.11	Validating Your Configuration.....	58-23

59 Integrating Microsoft SharePoint Server with Access Manager

59.1	What is Supported in This Release?.....	59-2
59.2	Introduction to Integrating With the SharePoint Server	59-2
59.2.1	About Windows Impersonation.....	59-3
59.2.2	Form Based Authentication With This Integration	59-3

59.2.3	Authentication With Windows Impersonation and SharePoint Server Integration	59-4
59.2.4	Access Manager Support for Windows Native Authentication	59-5
59.3	Integration Requirements	59-6
59.3.1	Requirements Confirmation	59-6
59.3.2	Required Access Manager Components	59-6
59.3.3	Required Microsoft Components	59-7
59.4	Preparing for Integration With SharePoint Server	59-9
59.5	Integrating With Microsoft SharePoint Server	59-11
59.5.1	Creating a New Web Application in Microsoft SharePoint Server	59-12
59.5.2	Creating a New Site Collection for Microsoft SharePoint Server	59-14
59.6	Setting Up Microsoft Windows Impersonation	59-15
59.6.1	Creating Trusted User Accounts	59-16
59.6.2	Assigning Rights to the Trusted User	59-17
59.6.3	Binding the Trusted User to Your WebGate	59-18
59.6.4	Adding an Impersonation Response to an Authorization Policy	59-19
59.6.5	Adding an Impersonation DLL to IIS	59-19
59.6.6	Testing Impersonation	59-22
59.7	Completing the SharePoint Server Integration	59-24
59.7.1	Configuring IIS Security	59-24
59.8	Integrating With Microsoft SharePoint Server Configured With LDAP Membership Provider	59-25
59.8.1	About Integrating With Microsoft SharePoint Server Configured With LDAP Membership Provider	59-26
59.8.2	Installing Access Manager for Microsoft SharePoint Server Configured With LDAP Membership Provider	59-27
59.8.3	Configuring an Authentication Scheme for Use With LDAP Membership Provider	59-28
59.8.4	Updating the Application Domain Protecting the SharePoint Web Site	59-29
59.8.5	Creating an Authorization Response for Header Variable SP_SSO_UID	59-30
59.8.6	Creating an Authorization Response for the OAMAuthCookie	59-31
59.8.7	Configuring and Deploying OAMCustomMembershipProvider	59-31
59.8.8	Enabling Logging for CustomMemberShipProvider	59-34
59.8.9	Ensuring Directory Servers are Synchronized	59-34
59.8.10	Testing the Integration	59-35
59.9	Configuring Single Sign-On for Office Documents	59-35
59.10	Configuring Single Sign-off for Microsoft SharePoint Server	59-35
59.10.1	Configuring a Custom Logout URL in SharePoint Server	59-36
59.10.2	Configuring Logout in SharePoint Server With Impersonation	59-36
59.11	Setting Up Access Manager and Windows Native Authentication	59-37
59.11.1	Setting Up Access Manager WNA	59-37
59.11.2	Setting Up WNA With SharePoint Server	59-37
59.11.3	Installing Access Manager for WNA and SharePoint Server	59-38

59.11.4	Testing Your WNA Implementation	59-39
59.12	Synchronizing User Profiles Between Directories	59-40
59.13	Testing Your Integration.....	59-40
59.13.1	Testing the SharePoint Server Integration.....	59-40
59.13.2	Testing Single Sign-On for the SharePoint Server Integration	59-41
59.14	Troubleshooting.....	59-41
59.14.1	Internet Explorer File Downloads Over SSL Might Not Work	59-41

60 Integrating Access Manager with Outlook Web Application

60.1	What is New in This Release?	60-1
60.2	Introduction to Integration with Outlook Web Application.....	60-1
60.2.1	About Impersonation Provided by Microsoft Windows.....	60-1
60.2.2	Access Manager 11g Support for Windows Impersonation	60-2
60.2.3	Single Sign-On for Authenticated Access Manager Users into Exchange	60-2
60.2.4	Confirming Requirements.....	60-3
60.3	Enabling Impersonation With a Header Variable.....	60-3
60.3.1	Requirements for Impersonation with a Header Variable.....	60-3
60.3.2	Creating an Impersonator as a Trusted User	60-4
60.3.3	Assigning Rights to the Trusted User	60-5
60.3.4	Binding the Trusted User to Your WebGate	60-6
60.3.5	Adding an Impersonation Response to An Application Domain.....	60-6
60.3.6	Adding an Impersonation DLL to IIS.....	60-7
60.3.7	Testing Impersonation.....	60-8
60.4	Setting Up Impersonation for Outlook Web Application (OWA).....	60-10
60.4.1	Prerequisites to Setting Impersonation for Outlook Web Application	60-11
60.4.2	Creating a Trusted User Account for Outlook Web Application.....	60-11
60.4.3	Assigning Rights to the Outlook Web Application Trusted User.....	60-11
60.4.4	Binding the Trusted Outlook Web Application User to Your WebGate.....	60-12
60.4.5	Adding an Impersonation Action to an Application Domain for Outlook Web Application	60-13
60.4.6	Adding an Impersonation dll to IIS.....	60-13
60.4.7	Configuring IIS Security	60-14
60.4.8	Testing Impersonation for Outlook Web Application.....	60-15
60.5	Setting Up Access Manager WNA for Outlook Web Application	60-16

61 Integrating Microsoft Forefront Threat Management Gateway 2010 with Access Manager

61.1	What is New in This Release?	61-1
61.2	Introduction to Integration with TMG Server 2010.....	61-1
61.2.1	About This Integration	61-1
61.2.2	About Confirming Certification Requirements	61-2
61.3	Creating a Forefront TMG Policy and Rules	61-2
61.3.1	Creating a Custom Policy for Forefront TMG.....	61-2

61.3.2	Creating a Forefront TMG Firewall Policy Rule	61-3
61.3.3	Verifying Forefront TMG Proxy Configuration.....	61-6
61.4	Installing and Configuring 10g Webgate for Forefront TMG Server	61-6
61.4.1	Installing 10g Webgate with TMG Server.....	61-6
61.4.2	Changing /access Directory Permissions	61-7
61.5	Configuring the TMG 2010 Server for the ISAPI 10g Webgate.....	61-7
61.5.1	Registering Access Manager Plug-ins as TMG Server Web Filters.....	61-8
61.5.2	Ordering the ISAPI Filters.....	61-8
61.5.3	Verifying Form-based Authentication	61-9
61.6	Starting, Stopping, and Restarting the TMG Server	61-9
61.7	Removing Access Manager Filters Before WebGate Uninstall on TMG Server	61-9
61.8	Troubleshooting	61-10
62	Integrating Access Manager with SAP NetWeaver Enterprise Portal	
62.1	What is Supported in This Release?	62-1
62.2	Supported Versions and Platforms	62-1
62.3	Integration Architecture	62-2
62.3.1	Process Overview: Integration with SAP NetWeaver Enterprise Portal	62-2
62.4	Configuring Oracle Access Management and NetWeaver Enterprise Portal 7.0.x.....	62-3
62.4.1	Before You Begin Configuring OAM and NetWeaver Enterprise Portal 7.0.x	62-3
62.4.2	Configuring the Apache HTTP Server as a Proxy	62-4
62.4.3	Configuring SAP NetWeaver Enterprise Portal for External Authentication.....	62-5
62.4.4	Adjusting the Login Module Stacks for using Header Variables.....	62-6
62.4.5	Configuring Access Manager for SAP Enterprise Portal	62-7
62.5	Configuring Oracle Access Management and NetWeaver Enterprise Portal 7.4.x.....	62-8
62.5.1	Before You Begin Configuring OAM and NetWeaver Enterprise Portal 7.4.x	62-9
62.5.2	Configuring Access Manager for SAP NetWeaver Enterprise Portal 7.4.x	62-9
62.5.3	Configuring Apache Web Server 2.0.x or 2.2.x	62-11
62.5.4	Configuring SAP Enterprise Portal 7.4 for External Authentication	62-12
62.5.5	Adjusting the Login Module Stacks for Using Header Variables	62-13
62.6	Testing the Integration	62-14
62.7	Troubleshooting the Integration.....	62-14
63	Integrating Oracle Access Manager with SAP NetWeaver Enterprise Portal Using OpenSSO Policy Agent 2.2	
63.1	What is Supported in This Release?	63-1
63.2	Registering the OpenSSO Agent.....	63-1
63.3	Installing the OpenSSO Policy Agent 2.2 on SAP Enterprise Portal	63-3
63.3.1	Post-Installation Steps.....	63-4
63.4	Deploying the Agent Software Delivery Archive	63-4
63.5	Making a Class Loader Reference to the Login Module	63-5
63.6	Modifying the SAP Enterprise Portal 7.0 / Web Application Server 7.0 Class Path	63-5
63.7	Deploying and Starting the Agentapp.war File	63-5

63.8	Using Telnet to Create a Reference Between agentapp and Library AmSAPAgent2.2	63-5
63.9	Adding the Login Module to the Stack	63-6
63.10	Modifying the Login Module Stack	63-6
63.11	Updating the ume.logoff.redirect.uri.....	63-7
63.12	Configuring the AMAgent.properties File.....	63-7
63.13	Testing the Integration	63-8

Part XVI Appendixes

A Integrating Oracle ADF Applications with Access Manager SSO

A.1	Introducing Oracle Platform Security Services and Oracle Application Developer Framework	A-1
A.1.1	Oracle Platform Security Services Single Sign-on Framework.....	A-1
A.1.2	Oracle Application Developer Framework	A-2
A.2	Integrating Access Manager With Web Applications Using Oracle ADF Security and the OPSS SSO Framework.....	A-3
A.2.1	Sample SSO Configuration for Access Manager	A-5
A.2.2	SSO Provider Configuration Details.....	A-6
A.3	Configuring Centralized Logout for Oracle ADF-Coded Applications.....	A-7
A.3.1	Centralized Logout Processing for Applications Coded to Oracle ADF Standards ..	A-8
A.3.2	Configuring Centralized Logout for ADF-Coded Applications with Access Manager	A-9
A.4	Confirming Application-Driven Authentication During Runtime	A-11

B Internationalization and Multibyte Data Support for 10g WebGates

B.1	Internationalization and Multibyte Data Support on Oracle Access Manager.....	B-1
B.1.1	Languages For Localized Messages	B-1
B.1.2	Bi-directional Language Support.....	B-3
B.1.3	UTF-8 Encoding	B-4

C Securing Communication

C.1	Prerequisites to Setting up a Secure Communication between OAM Servers and Webgates	C-1
C.2	Securing Communication Between OAM Servers and WebGates	C-1
C.2.1	About Certificates, Authorities, and Encryption Keys	C-4
C.2.2	About Security Modes and X509Scheme Authentication	C-4
C.2.3	The Importcert Tool	C-5
C.3	Generating Client Keystores for OAM Tester in Cert Mode	C-6
C.4	Configuring Cert Mode Communication for Access Manager	C-7
C.4.1	About Cert Mode Encryption and Files	C-7
C.4.2	Generating a Certificate Request and Private Key for OAM Server	C-8
C.4.3	Retrieving the OAM Keystore Alias and Password	C-9
C.4.4	Importing the Trusted, Signed Certificate Chain Into the Keystore	C-10

C.4.5	Adding Certificate Details to Access Manager Settings	C-12
C.4.6	Generating a Private Key and Certificate Request for WebGates	C-13
C.4.7	Updating WebGate to Use Certificates	C-13
C.5	Configuring Simple Mode Communication with Access Manager	C-15
C.5.1	About Simple Mode, Encryption, and Keys	C-16
C.5.2	Retrieving the Global Passphrase for Simple Mode.....	C-16
C.5.3	Updating WebGate Registration for Simple Mode	C-17
C.5.4	Verifying SIMPLE Mode Configuration	C-18
D	Reviewing Bundled, Generated, and Migrated Artifacts	
D.1	Bundled 10g IAMSuiteAgent Artifacts.....	D-1
D.1.1	Pre-Registered 10g IAMSuiteAgent	D-1
D.1.2	IAMSuiteAgent Security Provider Settings, WebLogic Administration Console	D-2
D.1.3	IAMSuiteAgent Registration	D-3
D.1.4	Resources Protected by IAMSuiteAgent.....	D-4
D.1.5	Pre-seeded IAM Suite Application Domain and Policies.....	D-5
D.2	Generated Artifacts: OpenSSO	D-8
D.2.1	Generated OpenSSOAgentAuthPlugin	D-9
D.2.2	Generated Host Identifier: OpenSSOAgent1	D-9
D.2.3	Generated Application Domain: OpenSSOAgent1	D-10
D.2.4	Generated Resources: OpenSSOAgent1	D-10
D.2.5	Generated Authentication Policy: OpenSSOAgent Application Domain	D-10
D.2.6	Generated Authorization Policy: OpenSSOAgent Application Domain.....	D-11
D.3	Migrated Artifacts: OpenSSO	D-11
D.3.1	Migrated User Identity Store: OpenSSOAgent1.....	D-12
D.3.2	Migrated Agents: OpenSSOAgent1.....	D-13
D.3.3	Migrated Authentication Module: OpenSSOAgent1.....	D-14
D.3.4	Migrated Host Identifier: OpenSSOAgent1	D-14
D.3.5	Migrated Application Domain: OpenSSOAgent1	D-14
D.3.6	Migrated Resources: OpenSSOAgent1.....	D-15
D.3.7	Migrated Authentication Policy: OpenSSOAgent1.....	D-15
D.3.8	Migrated Authorization Policy: OpenSSOAgent1	D-15
E	Troubleshooting	
E.1	Introduction to Oracle Access Management Troubleshooting.....	E-2
E.1.1	System Analysis and Problem Scenarios.....	E-2
E.1.2	LDAP Server or Identity Store Issues	E-3
E.1.3	OAM Server or Host Issues	E-4
E.1.4	Agent-Side Configuration and Load Issues.....	E-5
E.1.5	Runtime Database (Audit or Session Data) Issues.....	E-5
E.1.6	Change Propagation or Activation Issues.....	E-6
E.1.7	Policy Store Database Issues	E-6
E.2	My Oracle Support for Additional Troubleshooting Information.....	E-7

E.3	Administrator Lockout.....	E-7
E.4	Error During Federation Configuration After Upgrade from PS1 to PS2.....	E-8
E.5	Oracle Access Management Console Inconsistent State.....	E-8
E.6	AdminServer Won't Start if the Wrong Java Path Given with WebLogic Server Installation.....	E-9
E.7	Agent Naming Not Unique	E-9
E.8	Application URL Requirements.....	E-9
E.9	Authentication Issues	E-10
E.9.1	Anonymous Authentication Issues	E-10
E.9.2	X.509Scheme and SSL Handshake Issues.....	E-10
E.9.3	X.509 Protected Resource and Single Sign Off.....	E-11
E.9.4	X509CredentialExtractor Certificate Validation Error.....	E-12
E.10	Authorization Issues.....	E-12
E.10.1	Authorization Condition Error	E-12
E.10.2	LDAP Search Filter Test Results	E-12
E.10.3	Authorization Header Response Names.....	E-13
E.11	Cannot Access Authentication LDAP or Database	E-13
E.12	Cannot Find Configuration.....	E-13
E.12.1	Configuration Does Not Exist	E-13
E.13	Co-existence Between OSSO and Access Manager	E-14
E.14	Could Not Find Partial Trigger	E-14
E.15	Denial of Service Attacks.....	E-14
E.15.1	Protecting the OAM Server from Crashing Under Load	E-15
E.15.2	Compensating for Network Latency	E-16
E.15.3	Protecting OAM Servers from a Flood of HTTP Requests	E-16
E.16	Deployments with Freshly Installed 10g Webgates.....	E-17
E.16.1	Authentication Issues with 10g Webgates	E-17
E.16.2	Logout Issues with 10g Webgates	E-17
E.17	Diagnosing Initialization and Performance Issues.....	E-18
E.17.1	Diagnosing an Initialization Issue	E-18
E.17.2	Diagnosing a Performance Issue	E-18
E.17.3	Diagnosing Out-of-Memory Issues With a Heap Dump	E-19
E.18	Disabling Windows Challenge/Response Authentication on IIS Web Servers	E-19
E.19	Changing UserIdentityStore1 Type Can Lock Out Administrators	E-20
E.20	IIS Web Server Issues.....	E-20
E.20.1	Form Authentication or Pass-Through Not Working	E-20
E.20.2	IIS and General Web Component Guidelines.....	E-20
E.20.3	Issues with IIS v6 Web Servers	E-21
E.20.4	Page Cannot Be Displayed Error	E-22
E.20.5	Removing and Reinstalling IIS DLLs.....	E-22
E.21	Import and File Upload Limits.....	E-22
E.22	jps Logger Class Instantiation Warning is Logged on Authentication	E-23
E.23	Internationalization, Languages, and Translation.....	E-23

E.23.1	Automatically Generated Descriptions Are Not Translated	E-23
E.23.2	Console Looks Messy	E-23
E.23.3	Authentication Fails: Users with Non-ASCII Characters.....	E-24
E.23.4	Access Tester Does Not Work with Non-ASCII Agent Names.....	E-24
E.23.5	Locales, Languages, and Oracle Access Management Console Login Page	E-24
E.24	Login Failure for a Protected Page.....	E-25
E.25	OAM Metric Persistence Timer IllegalStateException: SafeCluster	E-25
E.26	Partial Cluster Failure and Intermittent Login and Logout Failures.....	E-25
E.27	RSA SecurID Issues and Logs.....	E-26
E.28	Registration Issues.....	E-26
E.28.1	Problem: Remote Registration Tool Failure	E-26
E.28.2	Problem: No ObAccessClient.xml File Generated	E-27
E.28.3	Problem: Partner Registration Failure	E-27
E.29	Rowkey does not have any primary key attributes Error	E-27
E.30	SELinux Issues	E-27
E.31	Session Issues	E-28
E.31.1	Session Impersonation Not Enabled by Default	E-28
E.31.2	Sessions with Oracle Access Manager 11.1.1 Integrated with Oracle Identity Federation 11.1.1	E-29
E.32	SSL versus Open Communication	E-29
E.33	Start Up Issues	E-29
E.33.1	AdminServer Startup (or Remote Registration Tool Failure) on AIX Platforms....	E-29
E.33.2	Connection to OAM Server could not be established: Exception in connecting to server. Connection refused.....	E-30
E.34	Synchronizing OAM Server Clocks.....	E-30
E.35	Trivial server error popup in Policy Manager	E-31
E.36	Using Coherence	E-31
E.37	Validation Errors	E-32
E.37.1	Resource not added to Authentication or Authorization Policy	E-32
E.37.2	Validation Failure - "description" attribute is not valid	E-33
E.38	Web Server Issues.....	E-33
E.38.1	Server Fails on an Apache Web Server	E-33
E.38.2	Apache v2 on HP-UX	E-34
E.38.3	Apache v2 Bundled with Red Hat Enterprise Linux 4.....	E-34
E.38.4	Apache v2 Bundled with Security-Enhanced Linux.....	E-34
E.38.5	Apache v2 on UNIX with the mpm_worker_module for Webgate	E-35
E.38.6	Domino Web Server Issues.....	E-36
E.38.7	Errors, Loss of Access, and Unpredictable Behavior	E-36
E.38.8	Known Issues for ISA Web Server	E-37
E.38.9	Oracle HTTP Server Fails to Start with LinuxThreads.....	E-37
E.38.10	Oracle HTTP Server Webgate Fails to Initialize On Linux Red Hat 4	E-38
E.38.11	Oracle HTTP Server Web Server Configuration File Issue.....	E-38
E.38.12	Issues with IIS v6 Web Servers	E-38

E.38.13	PCLOSE Error When Starting Sun Web Server	E-39
E.38.14	Removing and Reinstalling IIS DLLs.....	E-40
E.39	Windows Native Authentication	E-40

List of Examples

8-1	Audit log for privileged user granting a role to an identity.....	8-13
8-2	Audit log for privileged user revoking a role from an identity.....	8-14
8-3	Audit log for privileged user granting a role to an identity within an Application Domain.....	8-14
8-4	Audit log for privileged user revoking a role from an identity within an Application Domain.....	8-14
15-1	Example.....	15-20
15-2	Example.....	15-21
15-3	Example.....	15-22
15-4	Example.....	15-22
15-5	Example.....	15-23
15-6	Example.....	15-23
37-1	Example.....	37-10
37-2	Example	37-10
37-3	Example.....	37-11
37-4	Example	37-11
37-5	Example	37-12
37-6	Example	37-13
37-7	Example	37-13
37-8	Example	37-14
37-9	Example	37-15
37-10	Example	37-15

List of Figures

1-1	Oracle Access Management Overview.....	1-2
1-2	Access Manager 11g Components and Services.....	1-5
1-3	Access Manager 11g Component Distribution.....	1-5
2-1	Oracle Access Management Administrator Launch Pad.....	2-7
2-2	Self Service Launch Pad.....	2-8
2-3	SSO Agent Search Page.....	2-13
3-1	Oracle Access Management Configuration Options.....	3-2
3-2	Available Services.....	3-4
3-3	Common Settings Page (Collapsed View).....	3-6
3-4	Common Coherence Settings.....	3-8
3-5	Certificate Revocation List Dialog Box.....	3-10
3-6	OCSP/CDP Settings.....	3-11
5-1	Creating User Identity Store Registration	5-10
5-2	System Store Registration	5-15
5-3	Identity Directory Service Console Page.....	5-19
5-4	Create IDS Profile Page.....	5-21
5-5	Create IDS Repository Page.....	5-29
5-6	Add System Administrator Roles.....	5-31
6-1	OAM Server Registration Page with Proxy Tab Displayed	6-6
8-1	Audit to Database Architecture.....	8-5
8-2	Common Settings: Auditing Configuration.....	8-27
9-1	Log-Level Activation in the Default Log Configuration File.....	9-22
11-1	Server Processes Overview Page.....	11-3
11-2	OAM Server Metrics: Session Operations Monitoring Page.....	11-4
11-3	OAM Server Metrics: Server Operations Tab.....	11-5
11-4	OAM Server Metrics: WebGates Tab.....	11-6
11-5	Webgate Metrics: Connectivity Table	11-7
11-6	Webgate Metrics: Operations Overview Table	11-7
11-7	Webgate Metrics: Operations Detail Table	11-7
11-8	Webgate Metrics: Detached Information Table	11-8
11-9	OSSO Agent Monitoring Page with Operation Details.....	11-8
11-10	OSSO Agent Monitoring Process Overview Table	11-9
11-11	OSSO Agent Operation Details Table	11-9
11-12	OAM Metrics Table.....	11-12
11-13	Weblogic Metrics.....	11-12
12-1	Fusion Middleware Control (AS-Control) Deployment Architecture	12-2
12-2	OAM Farm Page in Fusion Middleware Control.....	12-4
12-3	Farm Navigation Tree in Fusion Middleware Control.....	12-5
12-4	Node Information Page in Fusion Middleware Control.....	12-6
12-5	Application Deployment Summary for the Selected Internal Application.....	12-6
12-6	Application Deployment Menu.....	12-7
12-7	WebLogic Server Domain Summary with Context Menu Exposed.....	12-8
12-8	Cluster Page	12-11
12-9	Key Metrics for Server Page	12-11
12-10	Aggregated Access Manager Component Metrics for the Cluster.....	12-15
12-11	Access Manager Component Metrics for a Single OAM Server Instance.....	12-15
12-12	Aggregated STS Component Metrics for the Cluster.....	12-16
12-13	STS Component Metrics for an Individual OAM Server Instance.....	12-17
12-14	Performance Summary Command.....	12-17
12-15	Performance Summary Page with Metric Palette	12-18
12-16	Access Manager Log Levels on the Log Configuration Tab.....	12-24

12-17	Log Levels for Security Token Service	12-24
12-18	Log Files Configuration Page.....	12-27
12-19	Typical Log Messages Page in Fusion Middleware Control.....	12-31
12-20	System MBean Browser and Attributes Tab.....	12-38
13-1	Access Manager Settings: Load Balancer.....	13-2
13-2	Access Manager Settings: Server Error Mode.....	13-3
13-3	Access Manager Settings: SSO.....	13-7
13-4	Common Policy Evaluation Caches.....	13-12
15-1	Create OAM 11g WebGate Page.....	15-3
15-2	Load Balanced Deployment.....	15-15
15-3	Expanded 11g WebGate Page with Defaults	15-24
15-4	WebGate Search Controls and Create Button.....	15-31
15-5	Key Generation.....	15-39
16-1	Global Session Details: Common Settings Page.....	16-11
16-2	Common Configuration: Session Management Page.....	16-15
17-1	Multi-Data Center System Architecture.....	17-2
17-2	Active-Active Deployment Mode.....	17-6
17-3	Active-Active Mode Failover.....	17-7
17-4	Multi-Data Center Deployment.....	17-8
17-5	Requests Served By Different Data Centers.....	17-13
17-6	Logout and Session Invalidation.....	17-15
17-7	Stretch Cluster Deployment.....	17-16
17-8	Traditional MDC Deployment.....	17-17
17-9	Active-Active Topology.....	17-18
17-10	Active-Active Topology Across Multiple Data Centers.....	17-19
17-11	Load Balancing Access Manager Components.....	17-20
17-12	Global Load Balancer Front Ends Local Load Balancer.....	17-21
19-1	Replication Flow.....	19-3
19-2	Starting Sequence Illustrated.....	19-6
19-3	Applying Custom Transformation Rules.....	19-12
21-1	Access Manager 11g Policy Model	21-8
21-2	Access Manager Shared Policy Components.....	21-8
21-3	Anatomy of Access Manager Policies.....	21-12
22-1	Default HTTP Resource Type Definition.....	22-5
22-2	Default Resource Type wl_authen.....	22-5
22-3	Default Resource Type TokenServiceRP Resource Type.....	22-6
22-4	Create Host Identifier Page.....	22-16
22-5	Native Kerberos Authentication Module.....	22-29
22-6	Native LDAP Authentication Module.....	22-30
22-7	Native X.509 Authentication Module.....	22-32
22-8	Access Manager Plug-ins for Customized Authentication Modules.....	22-38
22-9	Creating Custom Authentication Modules: General	22-39
22-10	Adding a Step and Associating a Plug-in.....	22-40
22-11	Plug-in Based Authentication Module Steps and Details.....	22-46
22-12	Steps Orchestration for Plug-in Based Authentication Modules.....	22-47
22-13	KerberosPlugin.....	22-48
22-14	Default KerberosPlugin Steps and Details.....	22-49
22-15	Default KerberosPlugin Steps and Orchestration.....	22-49
22-16	LDAPPlugin.....	22-49
22-17	Default LDAPPlugin Steps and Details.....	22-50
22-18	Default Orchestration of Steps for LDAPplugin.....	22-50
22-19	X509Plugin.....	22-50
22-20	X509Plugin Default Steps and Details.....	22-51
22-21	Default Orchestration for X509Plugin Steps.....	22-52

22-22	Password Policy Validation Module Plug-ins.....	22-52
22-23	Steps Orchestration: Password Policy Validation Plug-ins.....	22-53
22-24	Plug-ins Page.....	22-67
22-25	Plugin Details: Activation Status of Selected Plug-in.....	22-69
22-26	Default LDAPScheme Page.....	22-73
23-1	SSO Log-in with Embedded Credential Collector and OAM Agents.....	23-4
23-2	Example: Separate Resource WebGate and DCC WebGate Deployment	23-7
23-3	Combined DCC and WebGate Configuration.....	23-8
23-4	SSO Login Processing with OSSO Agents and ECC.....	23-10
23-5	OAP Tunneling with DCC.....	23-17
23-6	Enable SSL.....	23-19
23-7	Keystore Configuration.....	23-19
23-8	Add Private Key Alias.....	23-20
23-9	SSL Advanced Options.....	23-20
23-10	New X509 Scheme.....	23-24
24-1	Password Policy Configuration Page.....	24-4
24-2	Password Policy Validation Authentication Module with Orchestrated Plug-ins.....	24-20
24-3	Step Orchestration for Password Policy Validation Module.....	24-20
24-4	Server Error Mode for Password Management.....	24-26
25-1	Application Domains Search Page.....	25-6
25-2	Example Application Domain Summary Page.....	25-6
25-3	Search Results for Resources in an Application Domain.....	25-7
25-4	Authentication Policies Tab.....	25-8
25-5	Authentication Policy Page: Resources and Responses	25-8
25-6	Authorization Policies Page.....	25-9
25-7	Individual Authorization Policy Page.....	25-10
25-8	Individual Authorization Policy Resources tab.....	25-10
25-9	Token Issuance Policies Page.....	25-10
25-10	Create Resource Page in the Application Domain.....	25-15
25-11	HTTP Resources, Query String Resource URL Controls.....	25-27
25-12	Resource Search within an Application Domain.....	25-31
25-13	Sample Authentication Policies Page in the Application Domain.....	25-34
25-14	Sample Individual Authentication Policy Page	25-34
25-15	Sample Individual Authorization Policy Page.....	25-39
25-16	Individual Authorization Policy Conditions Tab.....	25-44
25-17	Add Condition Window	25-47
25-18	Condition Containers on the Authorization Policy Page.....	25-47
25-19	Add Identities Window	25-50
25-20	Identity Condition and Details.....	25-51
25-21	Add Search Filter Controls.....	25-52
25-22	Identity Conditions: Details.....	25-53
25-23	IP4 Range Conditions.....	25-58
25-24	Temporal Condition Type Details Page.....	25-59
25-25	Attribute Conditions Page.....	25-62
25-26	Add Attribute Condition Dialog	25-63
25-27	Authorization Policy Rules Tab: Simple Mode.....	25-68
25-28	Rules Tab: Expression Rule Mode.....	25-70
25-29	Adding a Resource Prefix for Policy Ordering.....	25-74
25-30	Authorization Policy Response in the Console.....	25-76
25-31	Simple Response Samples.....	25-80
25-32	Complex Response Sample	25-81
26-1	OAM Agent (PEP) and OAM Server (PDP) Inter-operability.....	26-4
26-2	User Interactions with the Access Tester.....	26-7
26-3	Access Tester Console.....	26-14

26-4	Server Connection Panel in the Access Tester.....	26-18
26-5	Protected Resource URI Panel in the Access Tester.....	26-21
26-6	Access Tester User Identity Panel.....	26-24
26-7	Test Case Workflow.....	26-29
28-1	Typical Deployment with OpenSSO and Access Manager.....	28-8
28-2	Create OpenSSO Agent Page.....	28-13
28-3	Expanded OpenSSO Web Agent Registration Page.....	28-16
28-4	Expanded OpenSSO J2EE Agent Registration Page.....	28-17
29-1	Create OSSO Agent Page.....	29-8
29-2	OSSO Agent Page and Confirmation Window.....	29-11
35-1	Second Factor Authentication Preferred Method Page.....	35-2
35-2	One Time Password Login Page.....	35-4
35-3	Access Request Notification Preferred Method Page.....	35-6
35-4	Access Request Notification Wait Screen.....	35-6
37-1	Available Services Page.....	37-27
38-1	New Identity Provider Page, Service Details Loaded from Metadata.....	38-3
38-2	New Identity Provider Page, Service Details entered Manually.....	38-4
38-3	Searching for Identity Providers.....	38-11
38-4	Attribute Sharing Plug-in Design.....	38-22
39-1	Identity Federation Service Settings Page.....	39-2
39-2	Keystore Settings.....	39-5
40-1	FederationScheme.....	40-2
40-2	FederationPlugin Steps.....	40-4
40-3	FederationPlugin Orchestration.....	40-4
40-4	Setting Up the Authentication Policy with FederationScheme.....	40-7
40-5	OIFScheme.....	40-8
40-6	OIFMTLDAPPlugin.....	40-9
40-7	Authorization Policy Response Tab.....	40-11
40-8	Adding a Federation Response Attribute to an AuthZ Policy.....	40-13
41-1	Security Token Service Architecture.....	41-9
41-2	Security Token Service Token Support.....	41-10
41-3	Token Translation at a Centralized Authority.....	41-11
41-4	Translating Tokens Behind a Firewall.....	41-11
41-5	Web Services SSO.....	41-12
42-1	Typical Token Ecosystem.....	42-1
42-2	Identity Propagation with the OAM Token.....	42-3
42-3	Process Flow During Identity Propagation.....	42-3
42-4	Identity Propagation Deployment.....	42-4
42-5	Identity Propagation Processing.....	42-5
42-6	Required v1.0 WebLogic Server Identity Assertion Providers.....	42-10
42-7	IAP-Security Token Service Details.....	42-11
42-8	LDAP Provider: IAP-DSEE.....	42-12
42-9	Default Identity Store Defined in Access Manager.....	42-12
42-10	Token Issuance Policy for Identity Propagation.....	42-13
42-11	/wssuser Endpoint for Identity Assertion.....	42-14
42-12	Default Identity Store Defined for Access Manager.....	42-21
42-13	Token Issuance Policy for Identity Propagation.....	42-21
42-14	/wss11user Endpoint for Identity Assertion.....	42-22
43-1	Default Endpoints, Policies, and Validation Templates.....	43-6
43-2	WS-Security 1.0 and 1.1 Policies.....	43-7
43-3	Security Token Service Page.....	43-10
45-1	Validation Templates Search Controls.....	45-3
45-2	Issuance Template Search Controls.....	45-3
45-3	Issuance Template: General Details and Defaults.....	45-6

45-4	Issuance Properties: Username Token Type.....	45-7
45-5	Issuance Properties: SAML Token Types.....	45-8
45-6	Security Details: SAML Tokens.....	45-10
45-7	New Validation Template page: General Page Defaults.....	45-17
45-8	New Validation Template: General Authentication Details.....	45-19
45-9	Token Mapping: SAML2 WS-Security Validation Template.....	45-22
45-10	Token Mapping, username-wstrust-validation-template.....	45-23
45-11	Token Mapping: x509-wss-validation-template.....	45-24
45-12	Endpoints Page.....	45-31
45-13	Token Issuance Policies and Conditions.....	45-34
45-14	Pre-defined Resource Type: TokenServiceRP	45-38
45-15	Search: Resource Type TokenServiceRP in Application Domain.....	45-38
45-16	New Custom Token Page.....	45-40
45-17	Custom Tokens Search Page and Controls.....	45-43
45-18	General Details: email-wstrust-valid-temp.....	45-46
45-19	Token Mapping: email-wstrust-valid-temp.....	45-46
45-20	General Details: email-issuance-temp	45-47
45-21	Issuance Properties: email-issuance-temp	45-48
46-1	New Requester Partner Page.....	46-4
46-2	New Relying Party Partners Page.....	46-5
46-3	Partner Search Controls.....	46-8
46-4	Requester Profile: General.....	46-9
46-5	Requester Profile: Token and Attributes.....	46-10
46-6	Relying Party Profile Token and Attributes.....	46-12
46-7	Token and Attributes: Issuing Authority	46-16
46-8	Issuing Authority Profile: Token Mapping Tab.....	46-18
46-9	Search Partner Profiles Page: Requester Profiles.....	46-22
48-1	First Time Device/Application Registration and Authentication Process.....	48-14
48-2	Mobile SSO Agent Requests Access Token from Access Manager.....	48-15
48-3	Mobile SSO Agent Has Valid Access Token in Credential Store.....	48-16
48-4	Mobile SSO Agent Does Not Have Valid Access Token in Credential Store.....	48-17
48-5	User Authentication Using REST.....	48-18
48-6	Authenticating User From Browser-based Web App on Registered Mobile Device....	48-19
48-7	48-21
48-8	Authenticating a Returning User with a Local Account.....	48-27
48-9	Authenticating a New User with No Local Account.....	48-29
48-10	Authenticating a User With an OAuth Identity Provider.....	48-31
48-11	Authenticating a User with Access Manager.....	48-33
48-12	Authenticating a User Locally.....	48-34
49-1	Using ODSM to create the PIN attribute in OUD.....	49-16
49-2	Using ODSM to create the pinperson object class.....	49-16
49-3	Using the OAM Console to create an IdentityStore.....	49-17
50-1	Social Identity Account Linking.....	50-21
52-1	OAuth 3-Legged Flow Diagram.....	52-5
52-2	Using a Split Request to get a Client Verification Code.....	52-6
52-3	The Complete Mobile App Authorization Request Flow.....	52-9
53-1	Mobile (top) and Federation (bottom) Identity Domain Screens.....	53-2
53-2	Identity Federation DefaultDomain Configuration Page.....	53-3
53-3	Mobile Security DefaultDomain Configuration Page.....	53-3
53-4	OAuth Services Service Profile Configuration Page.....	53-40
54-1	Password Generation Policies Search/Create Tab.....	54-58
54-2	New Password Generation Policy Summary Tab.....	54-59
54-3	Password Constraints Tab of a Password Generation Policy.....	54-61
54-4	Add Applications Dialog.....	54-62

54-5	Credential Sharing Groups tab.....	54-63
54-6	New Credential Sharing Group Page.....	54-65
54-7	Add Applications Dialog.....	54-65
54-8	Global Agent Settings Search tab.....	54-66
54-9	New Global Agent Settings Page.....	54-68
55-1	End to End Identity Context Process.....	55-3
55-2	End To End Identity Context Process Components.....	55-4
55-3	Identity Context Process Flow.....	55-10
55-4	OAM Authentication Provider Configuration.....	55-20
58-1	Various Clients Deployed on JBoss Application Server.....	58-6
58-2	JBoss Agent Deployed with an Oracle HTTP Server WebGate.....	58-7
58-3	Sample Integration Topology.....	58-7
59-1	Setting up a Trusted User Account for Windows Impersonation.....	59-17
59-2	Configuring Rights for the Trusted User in Windows Impersonation.....	59-18
59-3	Registering the Impersonation Module.....	59-21
59-4	Verifying Event Viewer Settings.....	59-23
59-5	Impersonation Authentication.....	59-25
60-1	Setting up a Trusted User Account for Windows Impersonation.....	60-5
60-2	Configuring Rights for the Trusted User in Windows Impersonation.....	60-6
60-3	Verifying Event Viewer Settings.....	60-9
60-4	Impersonation Authentication.....	60-14
C-1	Communication Channels for OAM Servers and WebGates.....	C-3
D-1	IAMSuiteAgent Settings in the WebLogic Administration Console.....	D-2
D-2	IAMSuiteAgent Registration.....	D-3
D-3	Resources Protected by the IAMSuiteAgent.....	D-5
D-4	IAMSuite Authentication Policy: OAM Admin Console Policy.....	D-6
D-5	Protected HigherLevel Policy: Authentication, LDAP Scheme.....	D-6
D-6	Protected LowerLevel Policy: Authentication, OIMScheme	D-7
D-7	Public Policy: Authentication, AnonymousSheme.....	D-7
D-8	IAM Suite Authorization Policy.....	D-8
D-9	IAM Suite Token Issuance Policy and Resource URLs.....	D-8
D-10	Generated Authentication Module: OpenSSOAgentAuthPlugin.....	D-9
D-11	Generated Host Identifier: OpenSSOAgent1.....	D-9
D-12	Generated Application Domain: OpenSSOAgent1.....	D-10
D-13	Application Domain Resources: OpenSSOAgent1.....	D-10
D-14	Generated Authentication Policy: OpenSSOAgent Application Domain.....	D-10
D-15	Generated Authorization Policy: OpenSSOAgent Application Domain.....	D-11
D-16	Migrated User Identity Store.....	D-12
D-17	Migrated Agent: OpenSSOAgent1.....	D-13
D-18	Migrated Authentication Module: OpenSSOAgent1.....	D-14
D-19	Migrated Host Identifier: OpenSSOAgent1.....	D-14
D-20	Migrated Application Domain: OpenSSOAgent1.....	D-14
D-21	Migrated Resources: OpenSSOAgent1.....	D-15
D-22	Migrated Authentication Policy: OpenSSOAgent1.....	D-15
D-23	Migrated Authorization Policy2 Condition: OpenSSOAgent1.....	D-15
D-24	Migrated Authorization Policy2: IP Condition Details.....	D-16

List of Tables

1-1	Access Manager Deployment Types.....	1-6
1-2	Features in Access Manager 11.1.2.....	1-7
1-3	Oracle Access Management Post-Installation Tasks.....	1-12
2-1	Language Codes For Login Pages.....	2-16
2-2	Oracle Access Management Language Selection Methods.....	2-17
2-3	OAM_LANG_PREF Cookie.....	2-18
2-4	Application Integration for Language Preference.....	2-18
3-1	Configuration Options.....	3-2
3-2	Common Services.....	3-4
3-3	Common Settings.....	3-6
3-4	Common Coherence Settings.....	3-8
3-5	OCSP Responder Configuration Options.....	3-13
4-1	Roles for Delegating Administration.....	4-2
5-1	Data Sources for Oracle Access Management.....	5-2
5-2	Data Sources for Oracle Access Management Services.....	5-3
5-3	Components That Use Identity Stores.....	5-9
5-4	User Identity Store Elements.....	5-10
5-5	Access Manager Keys and Storage.....	5-36
5-6	Keystores for Access Manager and Security Token Service.....	5-37
6-1	Conditions Requiring Server Restart.....	6-5
6-2	OAM Server Instance Settings.....	6-6
6-3	OAM Proxy Settings for an Individual OAM Server.....	6-7
6-4	Default Coherence Settings for Individual OAM Servers.....	6-9
7-1	Logging Files.....	7-2
7-2	Logging Defaults.....	7-2
7-3	Oracle Access Management Server-Side Component Loggers.....	7-3
7-4	Oracle Access Management Shared-Service Engine Component Loggers.....	7-4
7-5	Oracle Access Management Foundation API Component Loggers.....	7-4
7-6	Mapping of ODL to Java Levels.....	7-6
7-7	Oracle Security Token Service and Identity Federation Loggers.....	7-10
8-1	Oracle Business Intelligence Enterprise Edition Reports for OAM.....	8-6
8-2	Access Manager Administrative Audit Events.....	8-8
8-3	Access Manager Run-time Audit Events.....	8-10
8-4	REST Run-Time Audit Events.....	8-14
8-5	Mobile and Social Run-Time Audit Events.....	8-15
8-6	Categories of Audit Events for Identity Federation.....	8-17
8-7	Identity Federation Session Management Events.....	8-17
8-8	Protocol Flow Events for Identity Federation.....	8-18
8-9	Server Configuration Identity Federation	8-18
8-10	Security Events for Identity Federation.....	8-19
8-11	Security Token Service Configuration Management Operations.....	8-21
8-12	Security Token Service-specific Run-time Events.....	8-23
8-13	Audit Configuration Elements.....	8-28
9-1	Logging Levels.....	9-2
9-2	Log Configuration File Names for Components.....	9-5
9-3	Log Writers.....	9-10
9-4	Global Parameters in the First Compound List.....	9-12
9-5	Factors that Determine Whether Logging Is Active.....	9-17
9-6	Mandatory Log Configuration File Parameters.....	9-18
9-7	Log Data File Configuration Parameters.....	9-19
9-8	ParamName Values You Can Configure for Per-Module Logging Threshold.....	9-24

10-1	Accounts_Locked_Out Report Fields.....	10-3
10-2	Authentication_statistics Report Fields.....	10-4
10-3	AuthenticationFromIPByUser Report Fields.....	10-4
10-4	AuthenticationPerIP Report Fields.....	10-4
10-5	AuthenticationStatisticsPerServer Report Fields.....	10-5
10-6	All Errors and Exceptions Report Fields.....	10-5
10-7	Authentication Failures Report Fields.....	10-6
10-8	Authentication History Report Fields.....	10-6
10-9	Authorization History Report Fields.....	10-6
10-10	Multiple Logins From Same IP Report Fields.....	10-7
11-1	OAM Proxy Metrics.....	11-10
11-2	OAM Proxy Tuning Parameters.....	11-11
11-3	OpenSSO Proxy Server Events	11-13
11-4	OpenSSO Proxy Metrics: Server	11-14
11-5	OpenSSO Proxy Metrics: Agent.....	11-14
12-1	Farm Page Sections.....	12-4
12-2	Resulting Pages for Selected Nodes and Targets.....	12-10
12-3	Summary of Performance Overviews in Fusion Middleware Control.....	12-12
12-4	Access Manager Component Metrics.....	12-15
12-5	STS Component-Specific Metrics.....	12-17
12-6	Status and Controls on Performance Summary Pages.....	12-18
12-7	OAM Log Availability and Functions in Fusion Middleware Control.....	12-23
12-8	Log Levels Tab on Log Configuration Page.....	12-25
12-9	Log Files Elements	12-28
12-10	OAM Log Message Search Controls in Fusion Middleware Control.....	12-32
12-11	System MBean Browser.....	12-36
12-12	MBeans that Access Manager and Security Token Service Deploy.....	12-37
12-13	System MBean Browser.....	12-38
13-1	Access Manager Settings: Load Balancer.....	13-2
13-2	Server Error Mode.....	13-4
13-3	Error Trigger Condition, Modes, and Message Codes.....	13-4
13-4	External Error Codes, Trigger Conditions, and Recommended Messages.....	13-5
13-5	Access Manager Settings: SSO.....	13-7
13-6	Summary: Simple and Cert Mode	13-8
13-7	Server Common OAM Proxy Secure Communication Settings.....	13-10
13-8	Policy Evaluation Caches.....	13-12
14-1	Agent Types.....	14-2
14-2	Agent Registration and SSO Support	14-3
14-3	Run Time Processing Overview for Access Manager	14-5
14-4	Keys and Policies Generated During Agent Registration.....	14-8
14-5	Artifacts Associated with Agent Registration.....	14-9
14-6	Copying Generated Artifacts.....	14-9
14-7	Remote Registration Methods.....	14-10
14-8	Agent Registration and Configuration Update Artifacts.....	14-12
15-1	Elements on Create Pages for 11g and 10g OAM Agents.....	15-3
15-2	User-Defined WebGate Parameters.....	15-7
15-3	Elements on Expanded 11g and 10g WebGate/Access Client Registration Pages.....	15-25
15-4	Agent Search Controls.....	15-32
15-5	Environment Variables to Set within oamreg.....	15-36
15-6	Remote Registration Command Arguments: mode.....	15-36
15-7	Remote Registration Command Samples.....	15-36
15-8	Common Elements in Remote Registration Requests.....	15-38
15-9	Remote Registration Request Templates for OAM Agents.....	15-40
15-10	Elements in Extended OAM Agent Remote Registration Requests.....	15-41

15-11	Variables Required for Remote Registration.....	15-47
15-12	Files Returned by in-band Administrator to out-of-band Administrator.....	15-50
15-13	Remote Agent Update Modes and Input Files.....	15-52
15-14	Delta: OAM Agent Update versus Registration Request.....	15-52
16-1	Session Lifecycle States.....	16-3
16-2	Session Checks for State Changes.....	16-4
16-3	Session Removal.....	16-5
16-4	Application Domain-Specific Overrides.....	16-6
16-5	Session Content: Single Authentication Scheme.....	16-8
16-6	Session Outcomes: Multiple Authentication Schemes.....	16-10
16-7	Global Session Settings.....	16-11
16-8	Application-Specific Session Timing Overrides.....	16-13
16-9	Session Management Controls and the Results Table.....	16-15
17-1	Multi-Data Center Policy Configurations for Idle Timeout.....	17-22
17-2	Session Synchronization and Failover Scenarios.....	17-23
18-1	MDC Use Cases.....	18-2
18-2	oamMDC.properties Properties.....	18-10
18-3	Properties for MDC.properties File.....	18-11
18-4	partnerInfo.properties Properties.....	18-13
19-1	Replication States.....	19-3
19-2	Modifying Replication Agreement Properties.....	19-9
19-3	Modifying Replication Agreement Properties.....	19-15
21-1	Summary: SSO Components.....	21-2
21-2	Introduction to SSO Implementations.....	21-4
21-3	Access Manager Global, Shared Policy Components.....	21-9
21-4	Access Manager Policy Components.....	21-11
21-5	Condition Types.....	21-15
21-6	SSO Cookies.....	21-16
22-1	Comparison: Resource Types for Access Manager versus 10g.....	22-3
22-2	Resource Type Definition.....	22-6
22-3	Host Identifiers Examples.....	22-8
22-4	Host Identifier Definitions.....	22-16
22-5	Comparing the DCC and ECC.....	22-22
22-6	Native Authentication Modules.....	22-28
22-7	Native Kerberos Authentication Module Definition.....	22-29
22-8	Native LDAP Authentication Modules Definition.....	22-31
22-9	X509 Authentication Module Definition.....	22-32
22-10	Simple Form versus Multi-Step Authentication.....	22-36
22-11	General tab.....	22-39
22-12	Add New Step Entries, Steps Results Table, and Details Section.....	22-40
22-13	Parameter Details for Various Plug-ins.....	22-41
22-14	Steps Orchestration Tab.....	22-47
22-15	X509 Step Details (KEY_CERTIFICATE_ATTRIBUTE_TO_EXTRACT).....	22-51
22-16	Steps and Plug-ins in a Customized Step-up Authentication Module.....	22-57
22-17	Managing Custom Plug-ins Actions.....	22-67
22-18	Plugins Status Table.....	22-69
22-19	Example of Plugin Details Extracted from XML Metadata File.....	22-69
22-20	Authentication Scheme Definition.....	22-73
22-21	Pre-configured Authentication Schemes.....	22-77
22-22	Challenge Parameters in Pre-configured Schemes.....	22-88
22-23	User-Defined Challenge Parameters for Authentication Schemes.....	22-89
22-24	Advanced Rules Attributes.....	22-100
22-25	Sample Advanced Rules.....	22-101
22-26	Request Context Data.....	22-102

22-27	Location Context Data.....	22-103
22-28	Session Context Data.....	22-103
22-29	User Context Data.....	22-104
22-30	Challenge Parameters for 10g/11g Encrypted Cookies.....	22-105
22-31	Resource Webgate Support of POST Data Preservation and Restoration.....	22-107
22-32	Parameters Required for Authentication POST Data Handling.....	22-109
22-33	ECC and DCC: Long URL Handling.....	22-114
22-34	Parameters Required for Long URL Handling.....	22-115
23-1	Login Processing with Access Manager-Protected Resources.....	23-3
23-2	DCC Deployment Support.....	23-6
24-1	Password Policy Configuration Parameters.....	24-3
24-2	Password Policy Elements.....	24-4
24-3	Specifying Credential Collectors and Related Forms for Authentication.....	24-6
24-4	Credential Collector Password Pages.....	24-10
24-5	Password Management Forms and Functions.....	24-11
24-6	Location of Oracle-provided LDIFs for LDAP Providers.....	24-16
24-7	Key Password Attributes in a Password Policy.....	24-17
24-8	User Password Step Details.....	24-21
24-9	Included LDIF Schema Files.....	24-31
25-1	Resource Definition Elements.....	25-16
25-2	HTTP Resources Sample URL Values.....	25-18
25-3	Supported Wildcards in Resource URL Patterns (Precedence Order).....	25-20
25-4	Sample Resource URLs.....	25-22
25-5	Pattern Matching for Requested URLs.....	25-23
25-6	Query String Matching: Examples.....	25-24
25-7	Resource Evaluation Outcomes.....	25-29
25-8	Search Elements for a Resource in an Application Domain.....	25-31
25-9	Authentication Policy Elements and Descriptions.....	25-35
25-10	Authorization Policy Elements and Descriptions.....	25-39
25-11	Authorization Policy Condition Tab.....	25-45
25-12	Add Condition Window Elements.....	25-47
25-13	Add identities Elements.....	25-50
25-14	Add Search Filter Elements.....	25-52
25-15	LDAP Search Filter Examples for Access Manager.....	25-54
25-16	Temporal Condition Details.....	25-60
25-17	Access Conditions that Require Attribute-Type Conditions.....	25-61
25-18	Attribute Condition Elements.....	25-63
25-19	Attribute Names for Request Built-ins.....	25-63
25-20	Attribute Names for Session Built-ins.....	25-64
25-21	Attribute Condition Data (Aggregation of Conditions)	25-64
25-22	Authorization Policy Rules Elements.....	25-68
25-23	Rule Tab in Expression Mode.....	25-70
25-24	Operators for Expressions in Authorization Rules.....	25-71
25-25	Response Elements.....	25-76
25-26	Namespace Request Variables for Single Sign-On	25-78
25-27	Namespace Session Variables for Single Sign-On	25-79
25-28	Namespace User Variables.....	25-79
25-29	Simple Responses and Descriptions.....	25-80
25-30	Complex Responses.....	25-81
25-31	Fresh OSSO Installation: Protected Policy Response (Header).....	25-83
25-32	Remote Policy Management Modes, Templates, and Flags.....	25-86
25-33	Remote Management Template Elements.....	25-90
26-1	User Interactions: Tester Console Mode versus Command Line Mode Operations.....	26-8
26-2	Access Tester Supported System Properties.....	26-10

26-3	Access Tester Console Panels.....	26-14
26-4	Command Buttons in Access Tester Panels.....	26-15
26-5	Additional Access Tester Buttons.....	26-16
26-6	Access Tester Menus.....	26-17
26-7	Connection Panel Information.....	26-19
26-8	Protected Resource URI Panel Fields and Controls	26-21
26-9	Access Tester User Identity Panel Fields and Controls.....	26-24
26-10	Access Tester Capture Request Options.....	26-30
26-11	Generate Script Command.....	26-31
26-12	Test Script Control Parameters.....	26-32
26-13	Run Test Script Commands.....	26-34
26-14	Mismatched Results Reasons in the Statistics Document.....	26-37
27-1	Centralized Logout Circumstances.....	27-2
27-2	Logout Details After Registration (ObAccessClient.xml).....	27-4
28-1	Features: OpenSSO Agents with Access Manager.....	28-2
28-2	OpenSSO Policy Migration.....	28-3
28-3	OpenSSO Reliance on Access Manager.....	28-5
28-4	Access Manager Processing with OpenSSO.....	28-9
28-5	Elements on the New OpenSSO Agent Page.....	28-14
28-6	Relocating OpenSSO Artifacts.....	28-15
28-7	Expanded OpenSSO Agent Registration Elements.....	28-18
28-8	OpenSSO Request Files for Remote Registration.....	28-30
28-9	OpenSSO Agent Remote Registration Request.....	28-31
28-10	J2EE Request File Mappings to the Properties File.....	28-33
28-11	Mapping the Web Request File to the Properties File.....	28-34
28-12	Delta: OpenSSO Remote Registration versus Remote Updates.....	28-36
28-13	Other OpenSSO Information in this Guide.....	28-38
29-1	OSSO Agents with Access Manager.....	29-2
29-2	11g Access Manager SSO versus OSSO 10g Component Summary.....	29-2
29-3	Create OSSO Agent Page Elements.....	29-8
29-4	Relocating OSSO Artifacts.....	29-9
29-5	Expanded OSSO Agent Elements.....	29-11
29-6	OpenSSO Request Files for Remote Registration.....	29-14
29-7	OSSO-Specific Elements in a Remote Registration Request.....	29-14
29-8	Delta: OSSO Remote Registration versus Remote Updates.....	29-18
29-9	Other OSSO Information in this Guide.....	29-21
30-1	Installation Comparison with 10g WebGates.....	30-4
30-2	Comparison: Access Manager 11g versus 10g	30-6
30-3	Comparing Access Manager 11g Policy Model versus 10g.....	30-8
30-4	Preparing for 10g WebGate Installation with Access Manager 11g.....	30-17
30-5	Sample end_url Parameter Specifications.....	30-29
33-1	IIS 7 Webgate Windows Server 2008.....	33-7
35-1	Adaptive Authentication Plugin Properties.....	35-9
35-2	Server Side Configuration for Adaptive Authentication Service.....	35-11
36-1	Location URL Parameter Definitions.....	36-2
36-2	Offline Configuration URL Parameters.....	36-3
37-1	Supported SAML 2.0 NameID Formats.....	37-17
37-2	SAML 2.0 URLs for Identity Federation Acting As Identity Provider.....	37-19
37-3	SAML 2.0 URLs for Identity Federation Acting as Service Provider.....	37-19
37-4	Supported SAML 1.1 NameID Formats.....	37-20
37-5	SAML 1.1 URLs for Identity Federation Acting As Identity Provider.....	37-21
37-6	SAML 1.1 URL for Identity Federation Acting as Service Provider.....	37-22
37-7	OpenID 2.0 URLs for Identity Federation Acting As Identity Provider.....	37-24
37-8	OpenID 2.0 URLs for Identity Federation Acting as Service Provider.....	37-24

37-9	Configuring Identity Federation Settings.....	37-25
37-10	Implementing Identity Federation.....	37-26
38-1	Default Partner Profiles.....	38-2
38-2	Identity Provider Partner Settings.....	38-4
38-3	Attributes for Google OpenID Partner.....	38-9
38-4	Attributes for Yahoo OpenID Partner.....	38-9
38-5	Elements Used for IdP Provider Search.....	38-10
38-6	Service Provider Partner Settings.....	38-12
38-7	Sample SP Attribute Mappings.....	38-15
38-8	Attribute Mapping Value Expressions.....	38-16
38-9	Sample IdP Attribute Mappings.....	38-17
38-10	Default Federation Authentication Method and Access Manager Authentication Scheme Mappings.....	38-19
38-11	Configuration Parameters for Attribute Sharing Plug-in.....	38-25
38-12	Session Attributes Accessible To Attribute Sharing Plug-in.....	38-26
39-1	Federation Settings in the Console.....	39-2
39-2	General Federation Settings.....	39-3
39-3	Federation Proxy Settings.....	39-4
39-4	Keystore Settings for Federation.....	39-5
40-1	FederationScheme Element Definitions.....	40-3
40-2	FederationPlugin Steps.....	40-4
40-3	Orchestration of FederationPlugin.....	40-5
40-4	OIFScheme Definition.....	40-8
40-5	IFMTLDAPPlugin Steps.....	40-9
40-6	Policy Response Elements	40-11
40-7	Message Attribute Mapping.....	40-24
40-8	Office 365 Service Provider Attribute Values.....	40-24
41-1	Security Token Service 11g Infrastructure.....	41-3
41-2	Security Token Service Terms.....	41-4
41-3	Integrated Oracle Web Services Manager.....	41-7
43-1	Security Token Service Settings.....	43-11
44-1	Security Token Service Public Keys Used at Run Time.....	44-2
44-2	Keystore Mbeans.....	44-3
44-3	Partner Keys for WS-Trust Communications.....	44-8
44-4	Successful Certificate Validation Requirements.....	44-10
45-1	Search Validation Template.....	45-4
45-2	Issuance Template Requirements	45-6
45-3	Issuance Template: General Details	45-6
45-4	Issuance Properties: Username Token Type.....	45-7
45-5	Issuance Properties: SAML Token Types	45-9
45-6	Security Details: SAML Tokens.....	45-10
45-7	Issuance Template: Attribute Mapping, SAML Token	45-12
45-8	Validation Template Protocols.....	45-16
45-9	New Validation Template: General Details.....	45-17
45-10	New Validation Template: Authentication Details.....	45-19
45-11	New Validation Template: Token Mapping.....	45-24
45-12	Endpoints Page.....	45-32
45-13	Conditions tab: Token Issuance Policy.....	45-34
45-14	New Custom Token Elements.....	45-41
45-15	Custom Tokens Search Elements and Controls.....	45-43
46-1	Security Token Service Partners.....	46-2
46-2	Security Token Service Clients.....	46-2
46-3	Security Token Service Partner Entry.....	46-2
46-4	Security Token Service Partner Profile Data.....	46-3

46-5	Partner Elements for Partner Types.....	46-4
46-6	Elements for Security Token Service Partners.....	46-5
46-7	Profile: General.....	46-9
46-8	Requester Profile: Token and Attributes.....	46-11
46-9	Relying Party Profile Requirements.....	46-12
46-10	Token and Attributes Elements: Issuing Authority.....	46-16
46-11	Issuing Authority Token Mapping Elements.....	46-18
48-1	Features in Mobile and Social Based on the Companion Services Installed.....	48-3
48-2	Mobile and Non-Mobile Authentication Service Providers in Mobile and Social Services.....	48-7
48-3	Android, iOS, and Java Features of the Mobile and Social Services Client SDK.....	48-10
48-4	Token Requirements for the Mobile and Social Server.....	48-22
48-5	Identity Providers That Mobile and Social Natively Supports.....	48-25
49-1	Pre-configured Authentication Service Providers.....	49-6
49-2	Access Manager Authentication Service Provider Default Attributes.....	49-9
49-3	Webgate Agent for Authentication Service Provider Default Attributes.....	49-11
49-4	JWT Authentication Service Provider Default Attributes.....	49-11
49-5	JWT-OAM Authentication Service Provider Default Attributes.....	49-12
49-6	Access Manager Authorization Service Provider Default Attributes.....	49-20
49-7	Webgate Agent for Authorization Service Provider Default Attributes.....	49-20
49-8	User Profile Service Provider Default Attribute Names and Values.....	49-22
49-9	User Profile Service Provider Default Attribute Names and Values.....	49-23
49-10	Authentication Service Profile Default General Properties.....	49-26
49-11	Token Support and URI Category Information Default Properties.....	49-27
49-12	Authorization Service Profile Default General Properties.....	49-28
49-13	User Profile Service Profile Default General Properties.....	49-29
49-14	Security Handler Plug-in General Properties.....	49-31
49-15	Application Profile General Properties.....	49-32
49-16	Service Domain General Properties.....	49-35
49-17	Application Profile Selection Properties.....	49-36
49-18	Service Profile Selection Properties.....	49-38
49-19	User Profile Service Protection Properties.....	49-38
49-20	Authorization Service Protection Properties.....	49-39
49-21	OAAM Policies Supported By Mobile and Social.....	49-49
49-22	Mapping Terms Between OAAM and Mobile and Social.....	49-49
50-1	OpenID Protocol Attributes.....	50-4
50-2	OAuth Protocol Attributes.....	50-5
50-3	User Attributes Returned By Google.....	50-7
50-4	User Attributes Returned By Yahoo.....	50-7
50-5	User Profile Attributes Returned By Foursquare.....	50-8
50-6	User Profile Attributes Returned By Windows Live.....	50-8
50-7	Service Provider Interface Information Properties.....	50-14
50-8	Account Linking Properties.....	50-22
51-1	Attribute Settings for an Oracle Access Manager 11gR1 PS1 Authentication Service Provider.....	51-2
52-1	Default User Profile Services Endpoint Operations.....	52-13
52-2	User Profile Resource Server - Scope Settings.....	52-15
53-1	OAuth Service Profile Configuration Attributes.....	53-9
53-2	Web Client Attributes Names and Values.....	53-15
53-3	OAuth Service Provider Attributes for Access Manager.....	53-20
53-4	User Profile Service Attributes.....	53-26
53-5	OAuth Server Settings Attributes.....	53-32
53-6	Default OAuth JKS Keystore File and Settings File.....	53-34
55-1	Identity Context Schema Attributes.....	55-5

55-2	Mapping Identity Context Operations.....	55-10
56-1	Access Manager Support for RSA Features.....	56-2
56-2	RSA Features Not Supported.....	56-3
57-1	Sample Naming.....	57-7
58-1	JBoss Agent Composition.....	58-4
59-1	Component Requirements.....	59-7
59-2	Microsoft Requirements for this Integration.....	59-8
59-3	Create Web Application Options for Microsoft SharePoint Server.....	59-12
59-4	Create a Web Application to Host a Site Collection for SharePoint Server.....	59-15
60-1	Requirements for Impersonation with a Header Variable.....	60-4
62-1	Login Module Stacks for using Header Variables.....	62-7
62-2	Login Module Stacks for using Header Variables.....	62-13
63-1	63-3
63-2	63-5
63-3	Ticket Authentication Values.....	63-7
A-1	addOAMSSOProvider Command-line Arguments.....	A-4
B-1	Languages for Localized Messages	B-2
C-1	importcert Command Syntax.....	C-5
D-1	Comparing IAMSuiteAgent with 11g and 10g Webgates.....	D-4

Preface

This guide provides information on administration and configuration tasks using Oracle Access Management.

Audience

This document is intended for Administrators who are familiar with:

- Oracle WebLogic Server concepts and administration
- LDAP server concepts and administration
- Database concepts and administration (for policy and session management data)
- Web server concepts and administration
- Webgate and mod_osso agents
- Auditing, logging, and monitoring concepts
- Security token concepts
- Integration of the Policy store, Identity store, and familiarity with Oracle Identity Management and OIS might be required

Documentation Accessibility

For information about Oracle's commitment to accessibility, visit the Oracle Accessibility Program website at <http://www.oracle.com/pls/topic/lookup?ctx=acc&id=docacc>.

Access to Oracle Support

Oracle customers that have purchased support have access to electronic support through My Oracle Support. For information, visit <http://www.oracle.com/pls/topic/lookup?ctx=acc&id=info> or visit <http://www.oracle.com/pls/topic/lookup?ctx=acc&id=trs> if you are hearing impaired.

Related Documents

This Preface is for the *Oracle Fusion Middleware Administrator's Guide for Oracle Access Management*. It explains how to manage configuration and policies for Access Manager, Security Token Service, Identity Federation, Access Portal, Mobile and Social, Adaptive Authentication, Identity Context and other available services. For

more information, see the following documents in the Oracle Fusion Middleware 11g Release 2 (11.1.2.3) documentation set:

- *Oracle Access Management 11g Release 2 (11.1.2.3) Release Notes*
- *Oracle Fusion Middleware Installation Guide for Oracle Identity and Access Management*—Explains how to use the Oracle Universal Installer and the WebLogic Configuration Wizard for initial Access Manager 11g deployment. Installing 11g WebGates for Access Manager is also covered.
- *Oracle Fusion Middleware Developer's Guide for Oracle Access Management*—Explains how to write custom applications and plug-ins to functions programmatically, to create custom Access Clients that protect non-Web-based resources.
- *Oracle Fusion Middleware Upgrade Guide for Java EE*—For information about the types of Java EE environments available in 10g and instructions for upgrading those environments to Oracle Fusion Middleware 11g.
- *Oracle Fusion Middleware Upgrade Guide for Oracle Identity and Access Management*
- *Oracle Fusion Middleware Migration Guide for Oracle Identity and Access Management*
- *Tuning Performance*
- *Administering Oracle Fusion Middleware*—Describes how to manage a secure Oracle Fusion Middleware environment, including how to change ports, deploy applications, and how to back up and recover Oracle Fusion Middleware. This guide also explains how to move data from a test to a production environment.
- *Oracle Fusion Middleware Enterprise Deployment Guide for Oracle Identity Management*—For a step-by-step guide to deployment.
- *High Availability Guide*—For high availability conceptual information as well as administration and configuration procedures for Administrators, developers, and others whose role is to deploy and manage Oracle Fusion Middleware with high availability requirements.
- *Oracle Fusion Middleware WebLogic Scripting Tool Command Reference for Identity and Access Management*—Provides details on customized Identity and Access Management WLST commands.
- *Administering Web Services*—Describes how to administer and secure Web services.

Conventions

The following text conventions are used in this document:

Convention	Meaning
boldface	Boldface type indicates graphical user interface elements associated with an action, or terms defined in text or the glossary.
<i>italic</i>	Italic type indicates book titles, emphasis, or placeholder variables for which you supply particular values.
monospace	Monospace type indicates commands within a paragraph, URLs, code in examples, text that appears on the screen, or text that you enter.

What's New in This Guide?

This chapter describes changes and updates to this book. See the following sections for details.

- [Updates in July 2017 Documentation Refresh for 11g Release 2 \(11.1.2.3.0\)](#)
- [Updates in January 2017 Documentation Refresh for 11g Release 2 \(11.1.2.3.0\)](#)
- [Updates in October 2016 Documentation Refresh for 11g Release 2 \(11.1.2.3.0\)](#)
- [Updates in August 2016 Documentation Refresh for 11g Release 2 \(11.1.2.3.0\)](#)
- [Product Enhancements for Oracle Access Management 11.1.2.3.0](#)
- [Product Enhancements for Oracle Access Management 11.1.2.2.0](#)
- [Product Enhancements for Oracle Access Management 11.1.2.1.0](#)
- [Product Enhancements in Oracle Access Management 11.1.2.0.0](#)
- [Product and Component Name Changes with 11.1.2](#)

Updates in July 2017 Documentation Refresh for 11g Release 2 (11.1.2.3.0)

This revision of *Administrator's Guide for Oracle Access Management* contains content updates to address bug fixes.

The following topics are updated in this refresh:

- The KeyStores generated may be reused across data centers that are in CERT mode. See [CERT Security Mode](#). The Common Name to be entered for generating a certificate request and private key for OAM cluster and WebGates are updated in [Generating a Certificate Request and Private Key for OAM Server](#) and [Generating a Private Key and Certificate Request for WebGates](#) respectively.
- Results Time Limit (seconds) is not supported in 11.1.2.3.0. Alternative option is provided in [User Identity Store Settings](#).

Updates in January 2017 Documentation Refresh for 11g Release 2 (11.1.2.3.0)

This revision of *Administrator's Guide for Oracle Access Management* contains information about the product enhancements in the latest Bundle Patch of Oracle Access Management 11g Release 2 (11.1.2.3.0) and bug fixes.

Important: Ensure that you have applied the latest Bundle Patch for these enhancements to be functional.

- When NTLM and Kerberos authentications do not work with a browser (such as a non-domain attached browser), the OAM Server displays an authorization error page. You can customize this error page to invoke WNA fallback to FORM-based authentication. For more information, see [Configuring WNA Fallback to FORM-based Authentication Scheme](#).
- When trust relationships are not established between forests, configure Kerberos authentication for multiple forests using KerberosPlugin instead of Kerberos authentication module. For more information, see [Configuring WNA for Multi-Forest Environment with No Cross-Forest Trust](#).
- Oracle Identity Federation supports RSA 1.5 as the key transport algorithm by default. The key transport algorithm can be changed from RSA 1.5 to RSA-OAEP based on the requirement, by adding a new property, defaultkeytransportmethod in `oam-config.xml` using the WLST commands. For more information, see [Using WLST for Key Transport Algorithm](#).

Updates in October 2016 Documentation Refresh for 11g Release 2 (11.1.2.3.0)

This revision of *Administrator's Guide for Oracle Access Management* contains information about the product enhancements in the latest Bundle Patch of Oracle Access Management 11g Release 2 (11.1.2.3.0) and bug fixes.

Important: Ensure that you have applied the latest Bundle Patch for these enhancements to be functional.

- OAM Federation service is enhanced to support standard SAML2v-based interfaces and elements. As part of the feature, elements such as `AttributeConsumingService` in the SP metadata, `AttributeConsumingServiceIndex` in the SAML authentication request, and `NameQualifier` in the `<samlp:issuer>` tag are introduced. For more information, see [Attribute Consuming Service](#).
- When DCC authentication schemes are used, pre-authentication rules are unable to distinguish between internal and external URLs from different proxies. To support DCC authentication schemes, create a new pre-authentication rule. For more information, see [Supporting DCC Authentication Schemes with Pre-Authentication Rules](#)
- The new cookie `OAM_WNA_OPT_OUT` supports WNA FORM fallback mechanism. For more information, see [Configuring WNA Fallback to FORM-based Authentication Scheme](#)
- User is provided with an ability to access bookmarked login pages. For more information, see [Accessing Oracle Access Manager protected resource when login page is bookmarked](#)

Updates in August 2016 Documentation Refresh for 11g Release 2 (11.1.2.3.0)

This revision of *Administrator's Guide for Oracle Access Management* contains information about the product enhancements in the latest Bundle Patch of Oracle Access Management 11g Release 2 (11.1.2.3.0) and bug fixes.

Important: Ensure that you have applied the latest Bundle Patch for these enhancements to be functional.

- Multiple WebGate profiles can be updated simultaneously by grouping common parameters of WebGates into a WebGate template. For details, see [Bulk Updates to WebGates](#)
- The security level of an authentication scheme can be changed during the authentication process by enabling custom authentication plug-ins. For details, see [Changing Security Level of an Authentication Scheme during the Authentication Process](#)
- WebGates handle a large DCCtxCookie cookie by splitting it into multiple DCCtxCookie cookies. The number of DCCtxCookie cookies generated after the split is tracked by the new cookie, `DCCtxCookie_COUNT`.
- As an enhanced behavior, During SSO, IdP sends the group attributes in separate SAML statements instead of comma separated values if the `multivaluegroups` flag is set to `true`. For details, see [Multivalue Attributes in SAML Assertion](#)
-
- Auditing of system configuration operations performed by delegated administrators are captured under **GenericAdminOperation** audit event. For details, see [Auditing Events for Delegated Administrators](#)
- Access Tester provides an admin mode where a delegated admin user is authenticated without a password. For details, see [Validating User Authentication without Password](#)

Product Enhancements for Oracle Access Management 11.1.2.3.0

This list of enhancements has been developed for this Oracle Access Management 11.1.2.3.0 release. Where applicable, links to the documentation are included.

- This Oracle Access Management 11g Release 2 (11.1.2.3) release allows for two console interfaces. The familiar Oracle Access Management Console has been updated and streamlined, and a new Access Manager Policy Manager Console, deployable on a WebLogic Managed Server, has been introduced. Additional information on the two consoles can be found in [Oracle Access Management Console and the Policy Manager Console](#).
- [Integrating OAM Identity Provider With Microsoft Office 365 Service Provider](#)
- AP Proxy Application Logon Packaging, see [Configuring the Access Portal Service](#) .
- New Administrator Roles, see [Delegating Administration](#) .

- The Adaptive Authentication Service now offers multifactor authentication in addition to the standard user name and password. Additional security is enforced by adding a One Time Password (OTP) or a Push Notification step as a second factor in the authentication process. It is configured in tandem with the Oracle Mobile Authenticator mobile app. For details, see [Managing the Adaptive Authentication Service and Oracle Mobile Authenticator](#)
- WS-Federation 1.1 support has been implemented in the Federation Service using WLST commands. See [Using WS-Federation 1.1](#).
- Mobile and Social
 - Mobile Services has been renamed to Mobile and Social Services.
 - Mobile and Social Services (Mobile Services) and OAuth Services now use a direct connection to communicate with OAM. Prior to version 11.1.2.3, Mobile and Social only communicated with OAM using TCP/IP (that is, remote mode). Now communication defaults to local, which is faster. **Important!** If Mobile and Social is configured to communicate with **OAM 10g** in your environment, set the `OAM_LOCAL_MODE` attribute to `false`. For details, see [Defining, Modifying or Deleting an Authentication Service Provider](#) (for Mobile and Social Services) and [Configuring the Service Provider](#) (for OAuth Services).
- DCC Enhancements for the following use cases:
 - Access Manager SSO flows for all OOTB schemes including forms, basic, WNA, X509, TOTP, and RSA.
 - Unsolicited login where an external custom login page can submit to a DCC end point instead of the ECC.
 - Converged Federation Service flows for both SP and IDP. DCC is capable of tunneling SAML tokens to Access Manager.
 - OAAM step-up flows. DCC is capable of redirecting to OAAM and sending the user's context, then tunneling the TAP token back to Access Manager.
 - Flows in an MDC set-up.

See [Understanding Authentication Methods and Credential Collectors](#) and [Understanding Credential Collection and Login](#) .
- Multi-Data Centers documentation has been upgraded and expanded. See [Implementing Multi-Data Centers](#)
- A JSON Web Token Plug-in has been added. See [JSON Web Token Plug-in](#).
- Access to the Forgot Password URL using Access Manager is discussed in [Administering the Forgot Password URL](#).

Product Enhancements for Oracle Access Management 11.1.2.2.0

This list of enhancements has been developed for this Oracle Access Management 11.1.2.2.0 release. Where applicable, links to the documentation are included.

- [Understanding Multi-Data Centers](#)
- [Delegating Administration](#)

- [OAuth Service](#)

The Oracle Access Manager OAuth 2.0 Service provides a standards compliant OAuth 2.0 authorization server with support for both 3-legged and 2-legged OAuth flows and enables the OAuth 2.0 Client and the OAuth 2.0 Resource Server roles. It also provides support for mobile OAuth 2.0 clients (such as native applications on mobile devices) and includes built-in support for mobile application registration and device identification during the OAM OAuth 2.0 mobile flow ensuring trusted access from mobile devices and built-in server side single sign-on. It is ideally suited for enterprise scenarios that may require higher levels of security during an OAuth flow and would benefit from built-in OAM integrations provided by the OAM OAuth 2.0 service.
- [Introduction to Application Domain and Policy Creation](#)
- [Administering Identity Federation As An Identity Provider](#)
- [Managing Oracle Access Management Oracle Access Portal](#)
- [Understanding the Oracle Access Management Console](#)

Policy Management Enhancements include:

 - Right click menu items available for all search result tables
 - Duplicate Resources, Authentication Policies, Authorization Policies and Token Issuance Policies and create new objects using the duplicate (Copy of)
 - Search for the Host Identifier from the Resource page
 - New Administrator tab in the Application Domain edit screen
 - New Advance Rules tab (with Pre-Authentication and Post-Authentication sub tabs) in Authentication Policy
- For Granular Timeout and cookie-based session management, see [Maintaining Access Manager Sessions](#)
- SHA2 encryption for all WebGate servers
- [Configuring Policy Ordering](#)
- [Using Application Initiated Authentication](#)
- [Understanding Persistent Login](#) (Remember Me)
- Coexistence enhancements
- Support added for Internet Protocol version 6 (IPv6)

Product Enhancements for Oracle Access Management 11.1.2.1.0

The following list outlines the enhancements available with Oracle Access Management 11.1.2.1.0.

- Newly certified integrations described in:
 - [Integrating Access Manager with Outlook Web Application](#) : Outlook Web Application (OWA) 2010

- [Integrating Microsoft Forefront Threat Management Gateway 2010 with Access Manager](#) : Microsoft Forefront Threat Management Gateway (TMG) 2010
- [Integrating Access Manager with SAP NetWeaver Enterprise Portal](#): SAP Enterprise Portal v6.0 and v7.0
- (WebSphere Portal)
- Authentication POST Data preservation and restoration is explained in: "[Configuring Authentication POST Data Handling](#)".
- Long URL handling is explained in "[Long URL Handling During Authentication](#)".
- Step up authentication is described in "[Steps and Plug-ins in Customized Step-up Authentication Module](#)".
- Language selection on Login page is described in "[Choosing a User Login Language](#)".
- Configurable WebGate Request Context Cookie Expiry Time is explained in:
 - [Table 15-2](#)
 - "[OAMRequestContext](#)"

Product Enhancements in Oracle Access Management 11.1.2.0.0

Oracle Access Management 11.1.2.0.0 provides new functions and enhancements outlined in following topics.

- [November 2012 Book Refresh](#)
- [August 2012 Book Refresh](#)
- [Access Management Services](#)
- [Access Tester](#)
- [Attribute Type Authorization Condition](#)
- [Deprecation](#)
- [Detached Credential Collection](#)
- [Dynamic Multi-Factor/Multi-Step Authentication](#)
- [Identity Context](#)
- [Integration with Third Party Products](#)
- [LDAP Search Filters in Identity Conditions](#)
- [Leverage SubjectAltName Extension Data/Integrate with Multiple OCSP Endpoints](#)
- [Mobile and Social](#)
- [Multiple Identity Store Support](#)
- [OpenSSO Support](#)

- [Password Policy Management](#)
- [Query String Name and Value Parameters in a Resource Definition Pattern](#)
- [Resource Type TokenServiceRP for Non-Browser Client-enabled WebGate](#)
- [RESTful Services](#)
- [Shared Secret Key: Access Client and Software Developer Kit Enhancement](#)
- [Token Issuance Policy for Mobile and Social](#)
- [Tuning Performance](#)
- [User-Defined Parameters: 11g WebGate](#)

November 2012 Book Refresh

The following information has been added or updated:

- Chapter 1: Added "[System Requirements and Certification](#)".
- Chapter 2: Removal (redundant) has altered chapter numbers.
- Chapter 3: Moved password policy, refocused for ECC, into Chapter 16 with other authentication details.
- Chapter 6: Added descriptions of loggers to:
 - [Table 7-3](#)
 - [Table 7-4](#)
 - [Table 7-5](#)
- Chapter 12: Re-focused for 11g OAM Agents (WebGates and Access Clients).
- Chapter 13:
 - Combined console and remote registration for 11g OAM Agents.
 - Moved [Configuring 11g WebGate and Authentication Policy for DCC](#) to chapter 20.
- Chapter 15:
 - Added [Understanding Credential Collection and Login](#) .
- Chapter 16: Relocated authentication details with other shared policy components:
 - Combined console and remote registration for 11g OAM Agents.
 - Added "[Understanding Credential Collection and Login](#) "
 - Refocused and moved from chapter 3: "[Managing Global Password Policy](#)"
 - Moved "[Configuring 11g WebGate and Authentication Policy for DCC](#)" from chapter 3.
- Chapter 17:

- Added "[Understanding Remote Policy and Application Domain Management](#)".
- Added "[Managing Policies and Application Domains Remotely](#)".
- Chapter 20: Relocated OpenSSO Agent registration and management details here.
- Chapter 20: Relocated OSSO Agent registration and management details here.
- Chapter 22: Expanded 10g OAM Agent details to include console and remote registration updates, and logout with Access Manager.
- Appendix A: Relocated to relevant logout configuration details.

August 2012 Book Refresh

This book has been updated to address reported issues. Global updates include cosmetic changes and updated screens.

See Also:

The following topics are new or updated in this release.

- [Table 25-31](#) for details about obtaining subscriber DN information from Oracle Internet Directory.
 - [Table 22-13](#)
 - [Creating Remote Identity Provider Partners](#) for details about defining OpenID 2.0 IdP partners for federation.
-
-

Access Management Services

Several previously separate access products of the Oracle Identity Management portfolio are combined into one product: Oracle Access Management.

See Also:

- [Introducing Oracle Access Management](#)
 - [Managing Access Manager Settings and Agents](#)
 - [Managing Oracle Access Management Identity Federation](#)
 - [Managing Oracle Access Management Mobile and Social](#)
 - [Using Identity Context](#)
-
-

Access Tester

The Access Tester can validate the connections in the pool and make cache flush (SYNC_INFO) requests to be sent over a connection that is already established; instead of using out-of-band connection for cache flush requests.

See Also:

[Validating Connectivity and Policies Using the Access Tester](#)

Attribute Type Authorization Condition

Authorization conditions enable you to implement dynamic security policies and resulted in changes to the Policy Configuration interface in the Oracle Access Management Console:

- Authorization Conditions: The earlier constraint class is renamed as a Condition Type. Conditions contain no Allow or Deny specification; however, new Rules specify Allow or Deny access options.

See Also:

["Introduction to Authorization Policy Rules and Conditions"](#)

- A new condition type: Attribute.

See Also:

["Attribute-Type Conditions"](#)

- Use of Implied Constraints option in policies is replace, allowing you to create particular condition types by instantiating those and selecting rules.

See Also:

["Introduction to Authorization Policy Rules and Conditions"](#)

Deprecation

Standard Authentication Modules (LDAP, Kerberos, and X509) are targeted for deprecation in future releases. Oracle strongly recommends using native or custom Plug-ins rather than standard Authentication Modules.

See Also:

- [Orchestrating Multi-Step Authentication with Plug-in Based Modules](#)
 - *Oracle Fusion Middleware Developer's Guide for Oracle Access Management* if you want to create custom authentication plug-ins.
-
-

Detached Credential Collection

Detached credential collection is an additional capability of the 11g WebGate (OAM Agent). This is required for secure dynamic multi-factor/multi-step authentication. You can easily enable the 11g WebGate to use as a DCC; or continue using the embedded credential collector (ECC) in the OAM Server.

See Also:

["Configuring 11g WebGate and Authentication Policy for DCC"](#)

Dynamic Multi-Factor/Multi-Step Authentication

Multi-factor authentication requires a custom authentication plug-in to transmit information to the back-end authentication scheme several times during the login process. All information collected by the plug-in and saved in the context will be available to the plug-in through the authentication process. Context data can also be used to set cookies or headers in the user's login page.

See Also:

- *Oracle Fusion Middleware Developer's Guide for Oracle Access Management*
-
-

Identity Context

Identity Context leverages the context-aware policy management and authorization capabilities built into the Oracle Access Management platform. Identity Context secures access to resources using traditional security controls (roles and groups) as and dynamic data established during authentication and authorization (strength, risk levels, device trust, and so on).

See Also:

[Using Identity Context](#)

Integration with Third Party Products

Details of integrating Access Manager with third-party products have moved from the earlier to this book. The following integrations are supported:

See Also:

[Integrating Access Manager with Other Products](#)

- [Integrating RSA SecurID Authentication with Access Manager](#)
 - [Configuring Access Manager for Windows Native Authentication](#)
 - [Integrating JBoss with Access Manager](#)
 - [Integrating Microsoft SharePoint Server with Access Manager](#)
-
-

LDAP Search Filters in Identity Conditions

Access Manager authorization conditions accept a list of users, groups, and LDAP search filters as part of allowed or denied identities. LDAP search filters provide a simple way of specifying a target identity population without having to reorganize or

create new groups in the identity store (directory server). This brings to Access Manager 11g, parity with Oracle Access Manager 10g.

See Also:

["LDAP Search Filter Support in Identity Conditions"](#)

Leverage SubjectAltName Extension Data/Integrate with Multiple OCSP Endpoints

Access Manager support for personal identity verification (PIV) cards (a United States Federal smart card), is to use FASC-N and EDIPI attributes from the SubjectAltName extension to map the user during X.509 authentication. While multiple OCSP providers are not supported, you can use an OCSP Gateway or write a custom authentication plug-in that uses the OSDT OCSP APIs to validate against multiple OCSP providers.

See Also:

- ["Example: Leveraging SubjectAltName Extension Data and Integrating with Multiple OCSP Endpoints"](#)
-
-

Mobile and Social

Mobile and Social serves as an intermediary between a user seeking to access protected resources, and the back-end Oracle Access Management and Oracle Identity Management services that protect those resources. Mobile and Social services' pluggable architecture enables Administrators to add, modify, and remove Identity and Access Management services without having to update user installed software.

See Also:

[Managing Oracle Access Management Mobile and Social](#)

Multiple Identity Store Support

Administrators can install multiple user identity stores for Access Manager. Each identity store can rely on a different LDAP provider. Each authentication module (or plug-in within an authentication step) can be configured to use a specific user identity store.

See Also:

- ["About Using Multiple Identity Stores"](#)
 - ["Orchestrating Multi-Step Authentication with Plug-in Based Modules "](#)
-
-

OpenSSO Support

Access Manager supports Web and Java Agents deployed on Web or J2EE containers. Each OpenSSO Agent is a filter that is plugged into the container (Oracle WebLogic Server, JBoss, Apache, and so on) that hosts applications.

Access Manager provides an OpenSSO Proxy to handle requests for resources protected by OpenSSO Agents. The Oracle-provided OpenSSO Proxy facilitates single sign-on to OpenSSO Agent-protected applications by enabling communication between the agent and the OAM Server.

See Also:

- [Registering and Managing Legacy OpenSSO Agents](#)
 - *Oracle Fusion Middleware Upgrade Guide for Oracle Identity and Access Management*
-
-

Password Policy Management

Access Manager enables password policy management through the Oracle Access Management Console. The global password policy applies to Access Manager users when the Password Policy Validation Module is implemented. The password policy is stored within the policy store and applies to all resources protected by Access Manager.

See Also:

- ["Managing Global Password Policy"](#)
 - ["Configuring 11g WebGate and Authentication Policy for DCC"](#)
-
-

Query String Name and Value Parameters in a Resource Definition Pattern

The Policy Model supports Query String Name and Value Parameters in a Resource Pattern Definition:

See Also:

- ["Query String Name and Value Parameters for Resource Definitions"](#)
-
-

Resource Type TokenServiceRP for Non-Browser Client-enabled WebGate

A TokenServiceRP type resource represents resources for, and is based on, the Token Service Relying Party (required for non-browser clients such as Identity Connect).

See Also:

["Managing TokenServiceRP Type Resources in Application Domains"](#)

RESTful Services

supports programmatic RESTful services.

See Also:

Oracle Fusion Middleware Developer's Guide for Oracle Access Management

Shared Secret Key: Access Client and Software Developer Kit Enhancement

Custom Access Clients developed using the Access Manager 11g Access Software Developer Kit support the 11g Shared Secret Key Per Agent (WebGate or Access Client) security feature. Each agent has its own secret key that is shared between the Access Client and the OAM Server to encrypt or decrypt the host-based Access-Client-specific OAMAuthnCookie. Even if one Access Client is compromised, the impact is limited to that particular Access Client; no other Access Clients are affected.

Note:

There is no impact to existing 10g ASDK users. Oblix class wrappers can be modified to create Access Client instances with 10g mode transparently. However, to operate in 11g compatible mode, Oracle java APIs should be used.

Access Manager 11g Pure Java ASDK provides both Oracle Java APIs (in oracle.security.am.asdk packages) and Oblix Java APIs (in com.oblix.access packages). Access Manager 11g Pure Java Access Clients:

- Communicate with OAM Servers using Oracle Java APIs and either Oracle Access Protocol version 3 (or version 4 which supports Shared Secret Key Per WebGate security feature)
 - Communicate with 10g Servers using Oblix Java APIs and Oracle Access Protocol version 3 only (with no support for SSKPA)
-
-

See Also:

Oracle Fusion Middleware Developer's Guide for Oracle Access Management

Token Issuance Policy for Mobile and Social

A Token Issuance Policy is required for clients for Mobile and Social performing authentication and authorization.

See Also:

[Managing Oracle Access Management Mobile and Social](#) for details about Mobile and Social Authentication Service

Tuning Performance

A survey of topics is provided to help tune a deployed environment to ensure optimal performance and stability.

See Also:

Tuning Performance

User-Defined Parameters: 11g WebGate

11g WebGate works with browser clients. However, there are cases where a non-browser (Representational State Transfer (REST) client needs to access HTTP resources and perform authentication and authorization.

See Also:

- ["About 11g WebGate Functionality for Mobile and Social "](#)
 - [Managing Oracle Access Management Mobile and Social](#)
 - *Oracle Fusion Middleware Developer's Guide for Oracle Access Management*
-
-

Product and Component Name Changes with 11.1.2

Oracle Access Management provided some product and component name changes, as shown in the following table.

Item	In Oracle Access Management 11.1.2	In Oracle Access Management 11.1.1
Services	Access Manager	Access Manager
	Identity Federation	N/A
	Security Token Service	Security Token Service
	Mobile and Social	N/A
	Identity Context (always enabled)	
Agents	WebGate (OAM Agent)	WebGate (OAM Agent)
	Access Client (OAM Agent)	Access Client (OAM Agent)
	OSSO Agent	OSSO Agent
	OpenSSO Agent	N/A
Console Names	Oracle Access Management Console	Oracle Access Manager Console
Administrators	Administrator or Oracle Access Management Administrator	Oracle Access Manager Administrator

Item	In Oracle Access Management 11.1.2	In Oracle Access Management 11.1.1
Agent and Application Domain Registration Policy Creation	Oracle Access Management Console Remote registration tool for automated Agent registration, Application Domain creation with default security policies.	Oracle Access Manager Console Remote registration tool
Authorization	Conditions and Rules	Constraints

Part I

Introduction to Oracle Access Management

The Oracle Access Management, an enterprise-level security platform, includes Oracle Access Management Access Manager (Access Manager) and many incorporated services including (but not limited to) Identity Federation and Identity Context.

This section contains information on the available services as well as instructions on how to login and start using the Oracle Access Management Console. It contains the following chapters:

- [Introducing Oracle Access Management](#)
- [Getting Started with Oracle Access Management](#)

Introducing Oracle Access Management

Oracle Access Management provides an enterprise-level security platform, which comprises Oracle Access Manager and many incorporated services including (but not limited to) Identity Federation and Identity Context

The following topics provide a high-level overview of the Oracle Access Management architecture and services:

- [Understanding Oracle Access Management Services](#)
- [Understanding Oracle Access Management Access Manager](#)
- [System Requirements and Certification](#)
- [Understanding Oracle Access Management Installation](#)

1.1 Understanding Oracle Access Management Services

Oracle Access Management is a Java, Enterprise Edition (Java EE)-based enterprise-level security application that provides a full range of Web-perimeter security functions and Web single sign-on services including identity context, authentication and authorization; policy administration; testing; logging; auditing; and more.

It leverages shared platform services including session management, Identity Context, risk analytics, and auditing, and provides restricted access to confidential information. Many existing access technologies in the Oracle Identity Management stack converge in the Oracle Access Management stack as illustrated in [Figure 1-1](#).

Figure 1-1 Oracle Access Management Overview

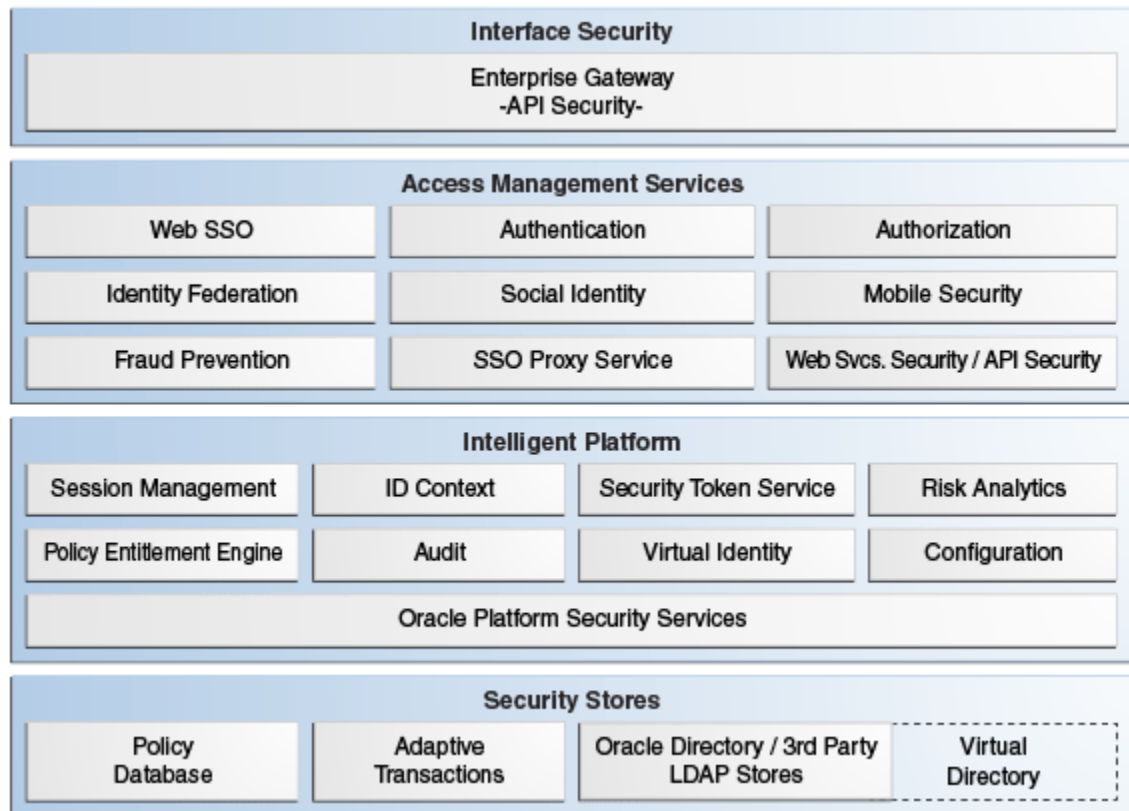

Starting with release 11.1.2, Oracle Access Management includes these services.

- Oracle Access Management Access Manager (Access Manager) is described in "[Understanding Oracle Access Management Access Manager](#)" and the following parts of this guide.
 - [Managing Common and System Configurations](#)
 - [Logging, Auditing, Reporting and Monitoring Performance](#)
 - [Managing Access Manager Settings and Agents](#)
 - [Managing Access Manager SSO, Policies, and Testing](#)
 - [Registering and Using Agents with Access Manager](#)
 - [Integrating Access Manager with Other Products](#)
- Oracle Access Management Identity Federation (Identity Federation) provides cross-domain single sign-on support using open federation protocol standards such as SAML and OpenID. Beginning with release 11.1.2, Identity Federation has been incorporated as a part of the Oracle Access Management platform, leveraging its shared services. This Identity Federation service includes a streamlined user interface and administration experience. For more information, see the chapters listed in [Managing Oracle Access Management Identity Federation](#)
- Oracle Access Management Security Token Service (Security Token Service) provides token validation and generation to facilitate access to services across

security domains and beyond organizational boundaries. Essentially the service acts as a trust-broker that receives and validates client requests and generates appropriate tokens for a requested resource. For more information, see the chapters listed in [Managing Oracle Access Management Security Token Service](#)

- Oracle Access Management Mobile and Social (Mobile and Social) acts as an intermediary between a user seeking access to protected resources, and the back-end Identity and Access Management services that protect the resources. Mobile and Social extends security and compliance to mobile platforms and simplifies integration with Social Identity services including Facebook and Google. Mobile and Social RESTful enables Identity and Access Management infrastructure and includes platform-specific developer kits for leading mobile platforms that enables developers to easily access security services and enable single sign-on across native and mobile browser-based applications. For more information, see the chapters listed in [Managing Oracle Access Management Mobile and Social](#)
- Oracle Access Portal is a hosted single sign-on proxy service that enables intranet and extranet applications with Oracle's form-fill single sign-on technology. It also provides REST interfaces that implement the Web Logon Manager end-user web application as well as custom front-end applications for user-level management of application credentials via desktop and mobile Web browsers. With the 11.1.2.2 release, Oracle Access Portal has been incorporated into the Oracle Access Management platform. For more information, see the chapters listed in [Managing Oracle Access Management Oracle Access Portal](#)
- The Adaptive Authentication Service is a One Time Password Authenticator that provides multifactor authentication in addition to the standard user name and password type authentication. It provides a framework for adding a custom second factor authentication processor that accepts a PIN from a user. For more information, see the chapters listed in [Managing the Adaptive Authentication Service and Oracle Mobile Authenticator](#)
- OAuth Services allows organizations to implement the open OAuth 2.0 Web authorization protocol in an Access Manager environment. OAuth Services enables a client to access resources protected by Access Manager that belong to another resource owner. An OAuth client can be an application or service created and controlled by your organization, or it can be an application or service created and controlled by another organization that requires access to resources protected by Access Manager. For more information, see the chapters listed in [Managing the Oracle Access Management OAuth Service](#)
- Identity Context provides context-aware security policy management that enables Administrators to control the level of security imposed in an application delivery environment through security frameworks provided by Oracle Identity Management. For more information, see the chapters listed in [Using Identity Context](#) .

OpenSSO 8.0 and Sun Access Manager 7.1 have also converged into Oracle Access Management 11.1.2. For more information, see:

- [Registering and Managing Legacy OpenSSO Agents](#)
- *Oracle Fusion Middleware Upgrade Guide for Oracle Identity and Access Management*

1.2 Understanding Oracle Access Management Access Manager

Oracle Access Management Access Manager (Access Manager) is the former (standalone) product named Oracle Access Manager. Access Manager provides the Oracle Fusion Middleware 11g single sign-on (SSO) solution.

It operates independently (as described in this book) but can also operate with the Access Manager Authentication Provider as described in the *Securing Applications with Oracle Platform Security Services*.

For information on the differences between Access Manager 11g, 10g and other software, see:

- ["Comparing Access Manager 11.1.2 and 10g"](#)
- ["Comparing Access Manager 11g SSO versus OSSO 10g"](#)
- ["Introduction to OpenSSO, Agents, Migration and Co-existence"](#)

Access Manager SSO allows users and groups to access multiple applications after authentication, eliminating the need for multiple sign-on requests. To enable SSO, a Web server, Application Server, or any third-party application must be protected by a WebGate (or mod_osso instance) that is registered as an agent with Access Manager. Administrators then define authentication and authorization policies to protect the resource. To enforce these authentication policies, the agent acts as a filter for HTTP requests.

Note:

WebGates are agents provided for various Web servers by Oracle as part of the product. Custom access clients, created using the Access Manager SDK, can be used with non-Web applications. Unless explicitly stated, information in this book applies equally to both.

You can also integrate any Web applications currently using Oracle ADF Security and the OPSS SSO Framework with Access Manager. (See [Integrating Oracle ADF Applications with Access Manager SSO](#).) The following sections contain more details on Access Manager.

- [About Components in Access Manager](#)
- [Understanding Access Manager Deployments](#)

1.2.1 About Components in Access Manager

Access Manager 11g sits on an instance of Oracle WebLogic Server and is part of the Oracle Fusion Middleware Access Management architecture.

While providing backward compatibility and co-existence with existing solutions, Access Manager 11g replaces and converges the earlier technologies Access Manager 10g and Oracle Application Server SSO (OSSO) 10g. [Figure 1-2](#) illustrates the primary Access Manager 11g components and services. The Protocol Compatibility Framework interfaces with OAM WebGates, mod_osso agents, and custom Access Clients created using the Access Manager Software Developer Kit (SDK).

Note:

This section does not illustrate or discuss all Access Manager components.

Figure 1-2 Access Manager 11g Components and Services

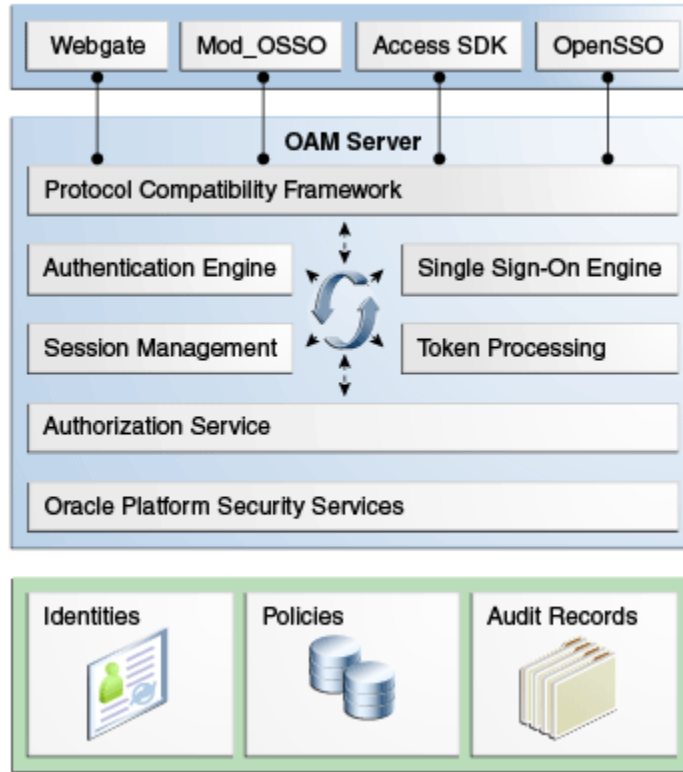
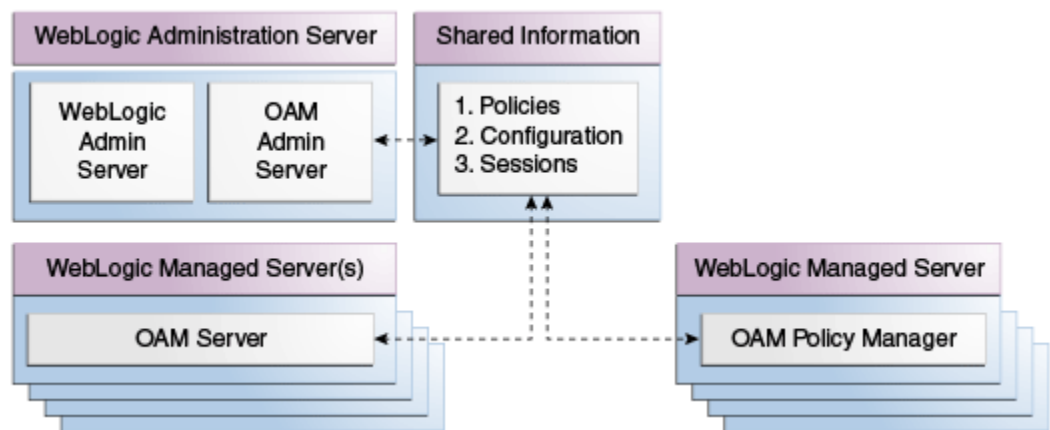

Figure 1-3 illustrates the distribution of Access Manager components.

Figure 1-3 Access Manager 11g Component Distribution



The Oracle Access Management Console resides on the Oracle WebLogic Administration Server (referred to as AdminServer). WebLogic Managed Servers hosting OAM runtime instances are known as OAM Servers. Information shared between the two includes:

- Agent and server configuration data

- Access Manager policies
- Session data (shared among all OAM Servers)

Starting in the 11g Release 2 (11.1.2.3), a Policy Manager Console can optionally be deployed on the WebLogic Managed Servers. See [Oracle Access Management Console and the Policy Manager Console](#) for details.

1.2.2 Understanding Access Manager Deployments

Your enterprise may have more than one Oracle Access Manager deployments. Irrespective of the deployment size, the configuration wizard installs various components in a newly created WebLogic Server domain.

[Table 1-1](#) describes the types of deployments in which Access Manager might be installed by your enterprise.

Table 1-1 Access Manager Deployment Types

Deployment Type	Description
Development Deployment	Ideally a <i>sandbox</i> -type setting where the dependency on the overall deployment is minimal
QA Deployment	Typically a smaller shared deployment used for testing
Pre-production Deployment	Typically a shared deployment used for testing with a wider audience
Production Deployment	Fully shared and available within the enterprise on a daily basis

During initial installation and configuration of Access Manager in your deployment, you create a new WebLogic Server domain (or extend an existing domain). Regardless of the deployment size or type, in a new WebLogic Server domain, the following components are installed using the Oracle Fusion Middleware Configuration Wizard.

- WebLogic Administration Server

Note:

In an existing WebLogic Server domain, the WebLogic Administration Server is already installed and operational.

- Oracle Access Management Console deployed on the WebLogic Administration Server
- A WebLogic Managed Server for Oracle Access Management services
- Application deployed on the Managed Server

See Also:

Understanding Oracle WebLogic Server Domains in *Understanding Domain Configuration for Oracle WebLogic Server*

Once the domain is configured, additional details are defined for OAM Servers, Database Schemas, (optional) WebLogic Managed Servers and clusters, and the following store types:

- **Policy Store:** The default policy store is file-based for development and demonstration purposes, and is not supported in production environments. All policy operations and configurations are performed directly on the database configured as the policy store in production environments.

See Also:

["Managing the Policy and Session Database "](#)

- **Identity Store:** The default Embedded LDAP data store is set as the primary user identity store for Access Manager.

See Also:

["Registering and Managing User Identity Stores "](#)

- **Keystore:** A Java keystore is configured for certificates for Simple or Certificate-based communication between OAM Servers and WebGates during authorization. The keystore bootstrap also occurs on the initial AdminServer startup after running the Configuration Wizard.

See Also:

["Managing the Policy and Session Database "](#)

1.3 About Access Manager 11.1.2.3.0

The following sections provide details on the features available (and not available) in Access Manager 11.1.2.3.0.

- [Features of Access Manager 11.1.2.3.0](#)
- [Features Not In Access Manager 11.1.2.3.0](#)

1.3.1 Features of Access Manager 11.1.2.3.0

[Table 1-2](#) provides an overview of Access Manager 11.1.2. For a list of names that have changed with 11.1.2, see "[Product and Component Name Changes with 11.1.2](#)".

Table 1-2 Features in Access Manager 11.1.2

Access Manager 11g	Description
Oracle Identity Management Infrastructure	Enables secure, central management of enterprise identities

Table 1-2 (Cont.) Features in Access Manager 11.1.2

Access Manager 11g	Description
Policy Enforcement Agents	<p>Resides with the relying parties and delegate authentication and authorization tasks to OAM Servers</p> <ul style="list-style-type: none"> • 11g OAM Agents, Registering and Managing OAM 11g Agents • 10g OAM Agents and the Pre-configured IAMSuiteAgent (10g OAM Agent), Registering and Managing 10g WebGates with Access Manager 11g • OpenSSO Agents, Registering and Managing Legacy OpenSSO Agents • 10g OSSO Agents (mod_osso), Registering and Managing Legacy OSSO Agents <p>Notes:</p> <p>Nine Administrator languages are supported.</p> <p>Unless explicitly stated, the term "Webgate" refers to both an out of the box Webgate or a custom Access Client.</p> <p>See Introduction to Agents and Registration for an introduction to agents.</p>
Server-side components	OAM Server (installed on a WebLogic Managed Sever)
Console	<p>Oracle Access Management Console provides access to all services and configuration details.</p> <p>See Getting Started with Oracle Access Management .</p>
Protocols for information exchange on the Internet	<ul style="list-style-type: none"> • Front-channel protocols exchanged between Agent and Server are HTTP and HTTPS. • Back-channel protocols: Authenticated clients can perform session operations using enhancements in the Oracle Access Protocol (OAP).
Proxy	<p>Provides support for legacy systems</p> <ul style="list-style-type: none"> • OAM Proxy supports legacy Access Manager implementations by acting as a legacy Access Server. <ul style="list-style-type: none"> "Managing the Access Protocol for OAM Proxy Simple and Cert Mode Security" "OAM Proxy Metrics and Tuning" • OSSO Proxy supports OSSO Agents by acting as the legacy OSSO Server. See Registering and Managing Legacy OSSO Agents. • Oracle-provided OpenSSO Proxy handles requests for resources protected by OpenSSO Agents. See Registering and Managing Legacy OpenSSO Agents . <p>See Also: About the Embedded Proxy Server and Backward Compatibility and the new Managing Oracle Access Management Oracle Access Portal</p>
Cryptographic keys	<p>Note: One key is generated and used per registered mod_osso or 11g Webgate. However, one single key is generated for all 10g Webgates.</p> <ul style="list-style-type: none"> • During 11g agent registration, one per-agent secret key shared is generated for encrypting and decrypting SSO cookies between 11g Webgate and OAM Server. See Registering and Managing OAM 11g Agents . • During 10g agent registration, a global shared secret key is generated across all of Access Manager 11g (all Agents and OAM Servers). See Registering and Managing 10g WebGates with Access Manager 11g. • During OSSO agent registration, One key per partner shared between mod_osso and OSSO server. See Registering and Managing Legacy OSSO Agents. • OpenSSO Agent Host- or Domain-based key stored locally in Agent bootstrap file on the Agent host. See Registering and Managing Legacy OpenSSO Agents . • During OAM Server registration, one server key is generated.

Table 1-2 (Cont.) Features in Access Manager 11.1.2

Access Manager 11g	Description
Keys storage	<ul style="list-style-type: none"> Agent-side: A per-agent key is stored locally in the Oracle Secret Store in a wallet file OAM Server-side: Per-agent keys, and server keys, are stored in the credential store on the server side
Encryption / Decryption (The process of converting encrypted data back into its original form)	<p>Introduces client-side cryptography and ensures that cryptography is performed at both the agent and server ends:</p> <ol style="list-style-type: none"> Webgate encrypts obrareq.cgi using the agent key. Note: obrareq.cgi is the authentication request in the form of a query string redirected from Webgate to OAM Server. OAM Server decrypts the request, authenticates, creates the session, and sets the server cookie. OAM Server also generates the authentication token for the agent (encrypted using the agent key), packs it in obrar.cgi with a session token (if using cookie-based session management), authentication token and other parameters, then encrypts obrar.cgi using the agent key. Note: obrar.cgi is the authentication response string redirected from the OAM Server to Webgate. Webgate decrypts obrar.cgi, extracts the authentication token, and sets a host-based cookie.
Policy Store	Database in production environments; file-based in demonstration and development environments, as described in " Managing the Policy and Session Database ".
Applications	<p>An application that delegates authentication and authorization to Access Manager and accepts headers from a registered Agent.</p> <p>Note: External applications do not delegate authentication. Instead, these display HTML login forms that ask for application user names and passwords. For example, Yahoo! Mail is an external application that uses HTML login forms.</p>
SSO Engine	<p>Manages the session lifecycle, facilitates global logout across all relying parties in the valid session, and provides consistent service across multiple protocols. Uses Agents registered with Access Manager 11g:</p> <ul style="list-style-type: none"> Authentication with the default embedded credential collector occurs across the HTTP (HTTPS) channel Authentication with the optional detached credential collector occurs across the Oracle Access Protocol (OAP) channel Authorization occurs across the Oracle Access Protocol (OAP) channel <p>See: Understanding Single Sign-On with Access Manager</p>
Session Management	<p>Global session specifications are enabled for all Application Domains and resources. In addition, Application Domain-specific session overrides can be configured.</p> <p>See Maintaining Access Manager Sessions.</p>
Policies	<p>Registered agents rely on Access Manager authentication, authorization, and token issuance policies to determine who gets access to protected applications (defined resources).</p> <p>See: Managing Policies to Protect Resources and Enable SSO</p>

Table 1-2 (Cont.) Features in Access Manager 11.1.2

Access Manager 11g	Description
Client IP	Maintains this client's age, and includes it in the host-based cookie: OAMAuthnCookie for 11g Webgate (or ObSSOCookie for 10g Webgate)
Response token replay prevention	Include RequestTime (the timestamp just before redirect) in obrareq.cgi and copy it to obrar.cgi (the authentication response string redirected from the OAM Server to Webgate) to prevent response token replay.
Multiple network domain support	Access Manager 11g supports cross-network-domain single sign-on out of the box. Oracle recommends you use Oracle Federation for this situation.
Cookies	<p>Host-based authentication cookie:</p> <ul style="list-style-type: none"> • 11g Webgate, One per agent: OAMAuthnCookie_host:port_random_number set by Webgate using the authentication token received from the OAM Server after successful authentication. Note: A valid OAMAuthnCookie is required for a session. • 11g Webgate, Transient: OAM_REQ is scoped to the OAM Server. OAM_REQ is set or cleared by the OAM Server if the Authentication request context cookie is enabled. Protected with keys known to the OAM Server only. This cookie is configured as a high availability option to store the state about the user's original request to a protected resource while his credentials are collected and authentication is performed. • 10g Webgate: One ObSSOCookie for all 10g Webgates. • One for the OAM Server: OAM_ID, which is scoped to the OAM Server. OAM_ID is generated by the OAM Server when the user is challenged for credentials and submitted to the server on every redirect to the server. <p>See Understanding Single Sign-On with Access Manager .</p>
Centralized log-out	<ul style="list-style-type: none"> • The logOutUrls (10g Webgate configuration parameter) is preserved. 10g logout.html requires specific details for Access Manager 11g. See Registering and Managing 10g WebGates with Access Manager 11g. • 11g Webgate parameters are new: Logout Redirect URL Logout Callback URL Logout Target URL <p>See Configuring Centralized Logout for Sessions Involving 11g WebGates.</p>
Case Insensitive Policy Resource Matching	<p>An optional setting is available to enable case insensitive policy resource matching. This is a global setting and both entries must be added to the oam-config.xml file under Policy Service > OAMPolicy Provider > properties:</p> <pre><Setting Name = "UseCaseInsensitiveResourceMatch" Type = "xsd:boolean">true</Setting> <Setting Name = "USE_CASE_INSENSITIVE_RESOURCE_MATCH" Type = "xsd:boolean">true</Setting></pre>

1.3.2 Features Not In Access Manager 11.1.2.3.0

Features provided in Access Manager 10g but not included in Access Manager 11.1.2 are as follows:

- Extensibility framework required for building custom authorization plug-in.
- Authorization for mod_osso-protected resources.

1.4 System Requirements and Certification

Ensure that your environment meets the system requirements such as hardware and software, minimum disk space, memory, required system libraries, packages, or patches before performing any installation.

Refer to the system requirements and certification documentation on Oracle Technology Network (OTN) for information about hardware and software requirements, platforms, databases, and other information.

The system requirements document covers information such as hardware and software requirements, minimum disk space and memory requirements, and required system libraries, packages, or patches:

<http://www.oracle.com/technetwork/middleware/ias/downloads/fusion-requirements-100147.html>

The certification document covers supported installation types, platforms, operating systems, databases, JDKs, and third-party products:

<http://www.oracle.com/technetwork/middleware/ias/downloads/fusion-certification-100350.html>

1.5 Understanding Oracle Access Management Installation

The following sections contain information and links regarding Access Manager installation and post-installation tasks.

- [About Oracle Access Management Installation](#)
- [Oracle Access Management and WebGates](#)
- [About Oracle Access Management Post-Installation Tasks](#)

1.5.1 About Oracle Access Management Installation

The *Oracle Fusion Middleware Supported System Configurations* document provides certification information on supported installation types, platforms, operating systems, databases, JDKs, and third-party products related to Oracle Identity Management 11g.

You can access the *Oracle Fusion Middleware Supported System Configurations* document by searching the Oracle Technology Network (OTN) Web site using the document name, or click the link below.

<http://www.oracle.com/technetwork/middleware/ias/downloads/fusion-certification-100350.html>

Using the Oracle Fusion Middleware Configuration Wizard, the following components are deployed for a new domain:

- WebLogic Administration Server
- Oracle Access Management Console deployed on the WebLogic Administration Server (sometimes referred to as the OAM Administration Server, or simply AdminServer)
- A Managed Server for Oracle Access Management
- An application deployed on the Managed Server

See the *Oracle Fusion Middleware Installation Guide for Oracle Identity and Access Management* for details on installation.

1.5.2 Oracle Access Management and WebGates

OracleAS 10g SSO deployments can be upgraded to use Oracle Access Management 11g SSO.

After upgrading and registering OSSO Agents, authentication is based on Access Manager 11g Authentication Policies. However, only OAM Agents (WebGates and Access Clients) use Access Manager 11g authorization policies. Over time, all mod_osso agents in the upgraded environment should be replaced with WebGates to enable use of 11g authorization policies.

For details about co-existence after the upgrade, see *Oracle Fusion Middleware Upgrade Guide for Oracle Identity and Access Management*.

1.5.3 About Oracle Access Management Post-Installation Tasks

Each WebLogic Server domain is a logically related group of Oracle WebLogic Server resources. WebLogic administration domains include a special Oracle WebLogic Server instance called the Administration Server. Usually, the domain includes additional Oracle WebLogic Server instances called Managed Servers, where Web applications and Web Services are deployed.

During initial deployment, the WebLogic Administrator userID and password are set for use when signing in to both the Oracle Access Management and WebLogic Server Administration Console. A different Administrator can be assigned for Oracle Access Management, as described in "[About Oracle Access Management Administrators](#)". Administrators can log in and use the Oracle Access Management Console for the post-installation tasks documented in [Table 1-3](#).

Table 1-3 Oracle Access Management Post-Installation Tasks

Service	Requirements
Access Manager	Enable Access Manager Service Register: <ul style="list-style-type: none"> • Data sources • OAM server instances • Agents for Access Manager • Application domains and policies that protect resources Configure: <ul style="list-style-type: none"> • Common settings, including session-timing • Certificate validation • Common password policy Configure Access Manager settings
Identity Federation	<ul style="list-style-type: none"> • Enable Identity Federation Service • Configure federation settings • Register identity provider and service provider partners
Security Token Service	<ul style="list-style-type: none"> • Enable Security Token Service • Configure Security Token Service settings • Register endpoints • Create token issuance and validation templates • Register partner profiles and partners

Table 1-3 (Cont.) Oracle Access Management Post-Installation Tasks

Service	Requirements
Mobile and Social	<ul style="list-style-type: none"><li data-bbox="623 323 1019 348">• Enable Mobile and Social Service<li data-bbox="623 352 1057 380">• Configure Mobile and Social Service

Getting Started with Oracle Access Management

Before you can work with Oracle Access Management, you must start your servers and log into the Oracle Access Management Console. Oracle Access Management 11.1.2 must have already been deployed as described in the *Oracle Fusion Middleware Installation Guide for Oracle Identity and Access Management*.

The following topics describe how to start and stop servers when you work with Oracle Access Management:

- [Starting and Stopping Servers in Your Deployment](#)
- [About Oracle Access Management Administrators](#)
- [Oracle Access Management Console and the Policy Manager Console](#)
- [Understanding the Oracle Access Management Console](#)
- [About Logging Into the Oracle Access Management Console](#)
- [Using the Oracle Access Management Console](#)
- [Command-Line Tools for Configuration](#)
- [Logging, Auditing, Reporting, and Monitoring Performance](#)
- [Configuring Oracle Access Management Login Options](#)

2.1 Starting and Stopping Servers in Your Deployment

The Oracle Access Management Console is deployed on the WebLogic Administration Server (AdminServer) thus, Oracle Access Management Administrators can access it only when the AdminServer is running.

If the Oracle Access Management Console is protected by a WebGate, the OAM Server must also be running. And the Node Manager must be started before the other servers. The following sections have more details.

- [Starting Node Manager](#)
- [Starting and Stopping WebLogic AdminServer](#)
- [Starting and Stopping Managed WebLogic Servers and Access Manager Servers](#)

2.1.1 Starting Node Manager

You can use the Node Manager, a Java utility, to perform common operations tasks for a Managed Server, regardless of its location with respect to its Administration Server.

Node Manager must run before you can start and stop the WebLogic AdminServer, or WebLogic managed servers hosting OAM Servers.

After installing and configuring Oracle Identity Manager, you need to configure the Node Manager for use with the WebLogic Administration Console (AdminServer) or Oracle Enterprise Manager Fusion Middleware Control. This configuration is done only once.

See "Configuring the Node Manager" in .

After you complete the configuration, you need to make sure that the Node Manager runs the `startNodeManager.sh` script. Oracle WebLogic Administration Server does not do this automatically.

```
$WLS_HOME/server/bin/startNodeManager.sh
```

See the *Oracle WebLogic Server Administrator Guide*.

To start Node Manager:

1. Change to your `$WLS_HOME/server/bin` directory.
2. Enable Start Scripts: Run `setNMPProps` to start the stack and instruct Node Manager to enable the use of start scripts (`StartScriptEnabled=true`).

```
./setNMPProps.sh
```

3. Start Node Manager.

```
./startNodeManager.sh
```

2.1.2 Starting and Stopping WebLogic AdminServer

Starting the WebLogic AdminServer the first time can take 12-15 minutes or more. This process must not be interrupted or terminated as policy data might be corrupted.

The following procedure describes starting and stopping the WebLogic AdminServer using the scripts located in your `$DOMAIN_HOME/bin` directory.

- **Unix:** `startWebLogic.sh` or `stopWebLogic.sh`
- **Windows:** `startWebLogic.cmd` or `stopWebLogic.cmd`

WARNING:

If `startWebLogic.cmd` (Windows) or `startWebLogic.sh` (Linux) is stopped for any reason (whether accidentally or because of a system crash or reboot), policy data might be corrupted. This would require removal and recreation of the domain and running the RCU again to recreate the OAM schema.

To start and stop WebLogic AdminServer:

1. Navigate to your `$DOMAIN_HOME/bin`.
2. Start AdminServer:
 - **Unix:** `./startWebLogic.sh`
 - **Windows:** `run startWebLogic.cmd`

3. Stop AdminServer:

- **Unix:** `./stopWebLogic.sh`
- **Windows:** `run stopWebLogic.cmd`

2.1.3 Starting and Stopping Managed WebLogic Servers and Access Manager Servers

You can perform all start and stop operations for managed WebLogic Servers hosting Oracle Access Management Servers (OAM Servers) from either a command prompt, the Oracle WebLogic Server Administration Console, the OAM Policy Manager Console, or the Oracle Enterprise Manager Fusion Middleware Control.

When using the command line scripts (located in the `$DOMAIN_HOME/bin` directory), the Managed Server name and the AdminServer URL are required as input.

The Unix system scripts are `startManagedWebLogic.sh` and `stopManagedWebLogic.sh`, and the Windows system scripts are `startManagedWebLogic.cmd` and `stopManagedWebLogic.cmd`.

To start and stop Managed WebLogic servers and Access Manager servers:

1. Navigate to `$DOMAIN_HOME/bin`.

2. Start OAM Server:

- **Unix:** `./startManagedWebLogic.sh MANAGED_SERVER_NAME ADMIN_SERVER_URL`
- **Windows:** `run startManagedWebLogic.cmd MANAGED_SERVER_NAME ADMIN_SERVER_URL`

If the managed server is named `oam_server1` and the AdminServer URL is `http://examplewlsadminhost.example.com:7001`, the start command run on a Unix system would be:

```
startManagedWebLogic.sh oam_server1 http://examplewlsadminhost.example.com:7001
```

3. Stop OAM Server:

- **Unix:** `./stopManagedWebLogic.sh MANAGED_SERVER_NAME ADMIN_SERVER_URL`
- **Windows:** `run stopManagedWebLogic.cmd MANAGED_SERVER_NAME ADMIN_SERVER_URL`

If the managed server is named `oam_server1` and the AdminServer URL is `http://examplewlsadminhost.example.com:7001`, the stop command run on a Unix system would be:

```
stopManagedWebLogic.sh oam_server1 http://examplewlsadminhost.example.com:7001
```

2.2 About Oracle Access Management Administrators

A single default LDAP group, the WebLogic Server Administrators group, is set in the Default User Identity Store (Embedded LDAP) designated as the System Store. The LDAP group, when assigned to a specified user, grants full system and policy configuration privileges.

Specifying a different LDAP group prohibits WebLogic Administrators from logging in to Oracle Access Management Console or from using administrative command-line tools.

Note:

Unless explicitly stated, the term Administrator in this guide refers to the Oracle Access Management System Administrator.

During initial deployment with the Oracle Fusion Middleware Configuration Wizard, the System Administrator userID and password are set. These credentials grant access to the:

- Oracle Access Management Console to register and manage system configurations, security elements, and policies.
See [Oracle Access Management Console and the Policy Manager Console](#) for details.
- WebLogic Server Administration Console to view the Summary of Server Configuration (Cluster, Machine, State, Health, and Listening Port) of deployed OAM Servers within the WebLogic Server domain, and also to Start, Resume, Suspend, Shutdown, or Restart SSL on these servers. See the *Administering Oracle Fusion Middleware* for more information.
- Custom Administrative command-line tools (including the WebLogic Scripting Tool and Remote Registration Tool) provide an alternative to the Oracle Access Management Console for a specific set of functions.
See [Command-Line Tools for Configuration](#).

Initially, a System Administrator user must log in to the Oracle Access Management Console using the WebLogic Administrator credentials set during initial configuration. However, your enterprise might require independent sets of Administrators: one set of users responsible for Oracle Access Management administration and a different set for WebLogic administration.

See [Understanding Administrator Roles](#).

2.3 Oracle Access Management Console and the Policy Manager Console

The Oracle Access Management 11g Release 2 (11.1.2.3) release allows for two console interfaces: **Oracle Access Management Console**, the full-featured graphical interface deployed on the WebLogic AdminServer and **Policy Manager Console**, the interface that can be deployed on one or more WebLogic Managed Servers.

- **Oracle Access Management Console:** The AdminServer will not display the Mobile Security Manager (MSM) and Mobile Security Access Server (MSAS) tiles in the Launch Pads (which will be displayed in the new Access Manager Policy Manager Console). The Oracle Access Management Console can be accessed at:

`http://wlsadminhost.example.com:7001/oamconsole`

The Oracle Access Management Console interface has been redesigned for 11g Release 2 (11.1.2.3).

See [Understanding the Oracle Access Management Console](#) .

- **Policy Manager Console:** It does not contain the full functionality available in the Oracle Access Management Console deployed on the AdminServer. The new Policy Manager Console has only the policy administration functionality of the familiar Oracle Access Management Console. It is deployed when using the

Oracle Mobile Security Suite (OMSS) or when more capacity is needed to support many delegated administrative users of Access Manager policies. The Policy Manager Console has mobile end points for the Mobile Security Manager (MSM) and Mobile Security Access Server (MSAS) components of the OMSS and can be accessed at:

`http://wlsadminhost.example.com:14150/access`

OAM customers upgrading from R2PS2 who do not plan on using the OMSS can continue to use the Oracle Access Management Console on AdminServer. OAM customers (or ex-Bitzer customers) who plan to use OMSS and are upgrading to 11g Release 2 (11.1.2.3) will need to use the Policy Manager Console but will also need to log into the AdminServer console to access the:

- Identity Directory Store management interface for OMSS, OAM, APS, OIC
- Certificate Revocation List interface for OAM
- Authentication Plug-ins interface for OAM

Note:

REST endpoints, WLST and the RREG servlet are available only on AdminServer.

2.4 Understanding the Oracle Access Management Console

The Oracle Access Management Console is a Web-based program that provides function controls for system and policy configuration. Oracle Access Management 11.1.2.3 introduces a redesigned Oracle Access Management Console.

This new Console displays a Launch Pad and subsequent pages based on the Administration Role to which a user is assigned a successful login. It is divided into Launch Pads and page-level tabs with forms and controls.

Any clicked shortcut appears as a named tab next to the Launch Pad. Each page is displayed only once. No warning is issued if you attempt to open the same page multiple times. The tab of the active page is white. Only the active page is visible and generally provides a work space where you can add, view, or modify related settings. Up to ten pages (tabs) can be open simultaneously. You can see named tabs for each page and click the tab to access a page that is concealed. See the following sections for details on the new Launch Pads.

- [System Launch Pad](#)
- [Access Manager Launch Pad](#)
- [Agents Launch Pad](#)
- [Help Desk Launch Pad](#)
- [Self Service Launch Pad](#)

Note:

The Oracle Access Management Console is designed for optimal display at a resolution of 1024x768.

2.4.1 System Launch Pad

The System Launch Pad will display when the user name of the Oracle Access Management System Administrator is entered.

See [About Oracle Access Management Administrators](#).

This role has access to all functions and features of the Console including policy creation, system configuration, and services settings (including Access Manager, Security Token Service, Identity Federation, Access Portal, and so on).

When the System Administrator is logged in, access is granted to five Launch Pads:

1. **Application Security** contains the functions generally associated with Oracle Access Manager and single sign-on (SSO). From this Launch Pad, click the appropriate link to gain access to agent registration, policy and policy objects creation, session management, password policy, authentication modules, and plug-ins.
2. **Federation** contains functions associated with Identity Federation (including links to configure and manage Identity, and Service Providers), the Security Token Service, Social Identity, OAuth Services and the Access Portal Service.

Note:

Some of these services are disabled by default and would need to be enabled under the Configuration Launch Pad.

3. **Mobile Security** contains functions specific to configuring and managing secure access to mobile applications and devices. This includes features like Mobile Security Manager, Mobile Security Access Server, Mobile Authentication and Mobile OAuth Services.
4. **Configuration** contains panels for managing the Oracle Access Management system settings. This includes enabling and disabling available Access services, configuring user identity stores and settings, certificate validation, server instances, and granting administrative permissions.
5. **Self Service** contains panels for managing the user's preferences and configurations. This also includes sessions and devices.

[Figure 2-1](#) shows the Oracle Access Management System Administrator Console with the Application Security Launch Pad displayed. This is the default login view. Note the four disabled tabs on the top right of the screenshot which, when clicked, will display the other Launch Pads visible by the System Administrator.

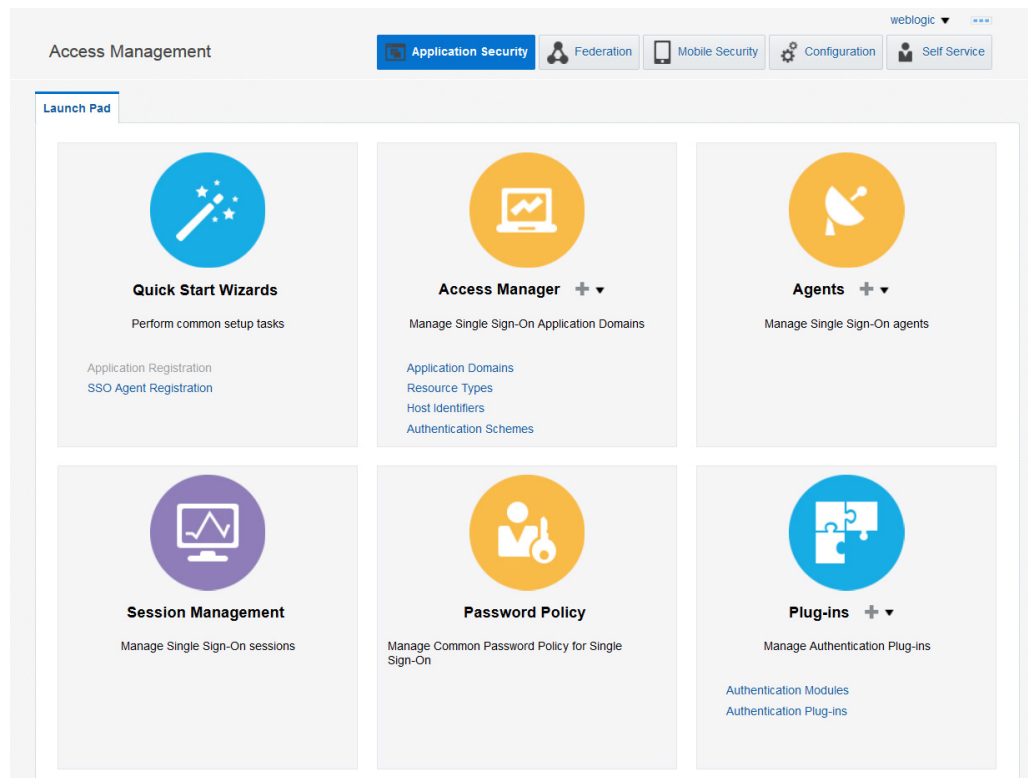
Figure 2-1 Oracle Access Management Administrator Launch Pad

2.4.2 Access Manager Launch Pad

The Oracle Access Manager Launch Pad and subsequent functionality are displayed when the user name entered is assigned to the Application Administrator (appadminuser) Role.

See [Understanding Administrator Roles](#).

This role has access to all functions and features of the Console that includes policy object creation and policy management. When the Application Administrator is logged in, access to the Launch Pads is limited to Access Manager and Automated Policy Synchronization (APS).

2.4.3 Agents Launch Pad

The Agents Launch Pad and the subsequent functionality are displayed when the user name entered is assigned to the Oracle Access Management Agent Administrator Role.

See [Understanding Administrator Roles](#).

This role has access to all functions and features of the Console that include management and configuration of SSO Agents.

2.4.4 Help Desk Launch Pad

The Help Desk Launch Pad and the subsequent functionality are displayed when the user name entered is assigned to the Oracle Access Management Help Desk Administrator Role.

See [Understanding Administrator Roles](#).

Users with this role lands on the `http://wlsadminhost.example.com:7001/oamconsole/faces/helpdesk.jspx` page after logging in. The System Administrator can access this console directly by entering the URL in the browser. Any one without the Help Desk Administrator role cannot access this page. If OMSS is disabled, only Session Management will be displayed.

2.4.5 Self Service Launch Pad

The Self Service Launch Pad and the subsequent functionality are displayed when any authenticated user without assigned roles is logged in.

The user lands on `http://wlsadminhost.example.com:7001/oamconsole/faces/selfservice.jspx` after logging in. It contains panels for managing the user's preferences and configurations.

Figure 2-2 includes sessions, and devices (if OMSS is enabled for the user).

Figure 2-2 Self Service Launch Pad

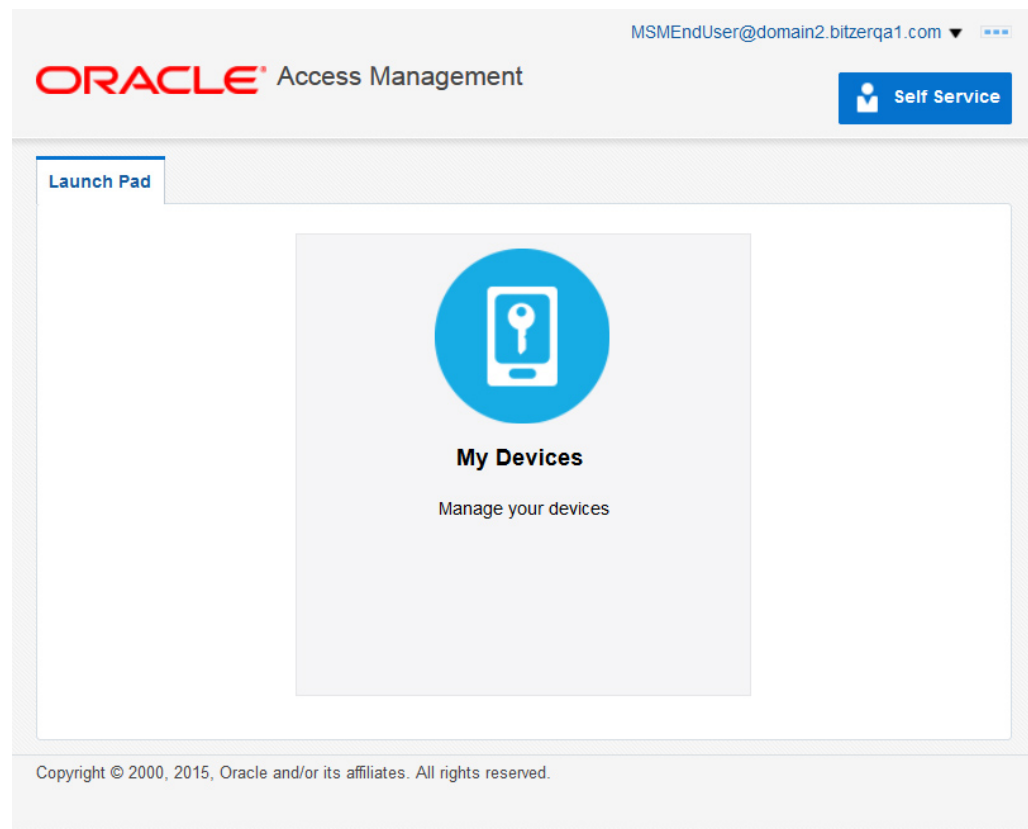

2.5 About Logging Into the Oracle Access Management Console

When accessing the Oracle Access Management Console, the WebLogic Server (AdminServer) host and port must be specified in the URL.

Let's assume the following sample URL, `https://wlsadminhost.example.com:7001/oamconsole`. In this URL, the following is true.

- HTTPS represents the Hypertext Transfer Protocol (HTTP) with the Secure Socket Layer (SSL) enabled to encrypt and decrypt user page requests and the pages returned by the Web server

- *wlsadminhost.example.com* refers to fully-qualified domain name of the computer hosting the Oracle Access Management Console (AdminServer)
- *7001* refers to the designated bind port for the Oracle Access Management Console, which is the same as the bind port used for AdminServer (the WebLogic Server Administration Console)
- */oamconsole/* refers to the Oracle Access Management Console Log In page

Note:

If you specify an OAM Server host and port (as you would to access the ODSM console), the AdminServer redirects to the managed server which produces a '404 Not Found' error.

When navigating to the */oamconsole* URL, the default Oracle Access Management Console login page is displayed. The following sections have details on logging into the Oracle Access Management Console.

- [Logging Into The Oracle Access Management Console](#)
- [Logging Into the Secure Oracle Access Management Console \(HTTPS\)](#)

Note:

Ensure that you use the correct administrative credential to log in. Initially, the LDAP group for the Oracle Access Management Console Administrator is the same as the LDAP group defined for the WebLogic Server Administration Console (Administrators) and the common Default System User Identity Store store is the WebLogic Embedded LDAP.

2.5.1 Logging Into The Oracle Access Management Console

With appropriate administrative credentials, you can log into the Oracle Access Management Console.

Use this procedure to log in to the Oracle Access Management Console.

1. In a browser window, enter the URL to the Oracle Access Management Console using the appropriate protocol (HTTP or HTTPS). For example:

```
https://hostname:admin_server_port/oamconsole/
```

2. On the Log In page, enter the Oracle Access Management Console Administrator credentials. For example:

Username: *Admin_login_id*

Password: *Admin_password*

Language: English

See [Choosing a User Login Language](#).

3. Click the Login button.

- **Successful:** The Oracle Access Management Console Welcome page is displayed.
- **Not Successful:**
See [Administrator Lockout](#).

See Also:

[About Oracle Access Management Administrators](#).

2.5.1.1 Accessing Oracle Access Manager protected resource when login page is bookmarked

Oracle Access Manager (OAM) renders a login page on accessing an application protected by OAM. System Administrators can specify where they want to redirect the user to, if the user has bookmarked the login page. They can specify any protected resource URL as the default page under **Challenge Parameters** field of the authentication scheme. The login page URL will contain a context to locate the landing page. When a bookmarked login page is accessed, OAM server will redirect the user to the default login page defined in the authentication scheme that is tied to the login page.

Following is an example to set Challenge Parameter in Authentication scheme:

```
hostIdentifier=oam11g and bookmarkDefaultPage=http://example.com:7777/landingpage.html
```

In the above example `landingpage.html` will be defined as a protected resource and `oam11g` is the host identifier.

The following Oracle Access Manager server behavior is pertinent on accessing a bookmarked login page:

- Oracle Access Manager server will redirect the user to the default login page defined in the authentication scheme that is tied to the login page.
- If there is no default page defined in the authentication scheme that is tied to the login page, then Oracle Access Manager server will redirect the user to the default login page defined in the default authentication scheme.
- If there is no default page defined both in the authentication scheme that is tied to the login page and the default authentication scheme then the following error message will be seen:

```
System error. Please re-try your action. If you continue to get this error, please contact the Administrator.
```

Note: Bookmarked login page contains a query parameter named 'bmctx'. The parameter and its value are required to be submitted to the oam server when login credentials are submitted.

2.5.2 Logging Into the Secure Oracle Access Management Console (HTTPS)

After enabling SSL on the Adminserver and OAM Managed Server, or after configuring administration port (HTTPS), you can add the CA cert to the libOVD keystore. This allows logging in without connection issues.

To go into the Secure Oracle Access Management Console (HTTPS):

1. Change to the directory that contains the DemoIdentity.jks.

```
$ cd $MIDDLEWARE_HOME/wlserver_10.3/server/lib/
```

2. Export the CA certificate from the Weblogic keystore using the following commands.

The `-list` command prints the contents of the keystore for reference. DemoIdentityKeyStorePassPhrase is the default password for the keystore DemoIdentity.jks.

```
$ keytool -list -keystore DemoIdentity.jks
-storepass DemoIdentityKeyStorePassPhrase
```

```
$ keytool -exportcert -keystore DemoIdentity.jks
-storepass DemoIdentityKeyStorePassPhrase -alias demoidentity
-file ~/demoidentity.cer
```

3. Import the Weblogic CA certificate to the libOVD keystore.

```
cd $DOMAIN_HOME/config/fmwconfig/ovd/default
```

```
mkdir keystores
```

```
cd keystores
```

```
$ keytool -importcert -keystore adapters.jks -storepass New_Password
-alias demoidentity -file ~/demoidentity.cer
```

4. Print the contents of the keystore to verify the import.

```
$ keytool -list -keystore ./adapters.jks -storepass
New_Password
```

5. Add the password for the imported keystore to trustStorePassword in the server.os_xml file.

```
vim server.os_xml
```

```
server.os_xml: <keystore>keystores/adapters.jks</keystore>
```

```
server.os_xml: <trustStore>keystores/adapters.jks</trustStore>
```

```
<trustStore>keystores/adapters.jks</trustStore>
```

```
<trustStorePassword>New_Password</trustStorePassword>
```

6. Change the value of ADMIN_URL in startManagedServer.sh to point to the SSL port of the Weblogic server.

7. Restart both Adminserver and OAM Managed Server.

8. Log in as documented in [Logging Into The Oracle Access Management Console](#).

2.6 Using the Oracle Access Management Console

Log on to the Oracle Access Management console to perform the common console functionality like accessing SSO Agent search page to search specific elements, accessing online help, and logging out of Oracle Access Management console.

The following topics describe common console functionality:

- [Logging Out of the Oracle Access Management Console](#)
- [Accessing Online Help in the Oracle Access Management Console](#)
- [SSO Agent Search Page](#)

2.6.1 Logging Out of the Oracle Access Management Console

The Sign Out link appears in the upper-right corner of the Oracle Access Management Console. Click the Sign Out link to conclude your session. Oracle recommends that you also close the browser window after signing out.

To sign out of the Oracle Access Management Console:

1. Expand the drop down list under the name of the user that is logged in and select Sign Out.
2. Close the browser window.

2.6.2 Accessing Online Help in the Oracle Access Management Console

At any time while using the Oracle Access Management Console, you can click the Help link located in the drop down menu under the user name at the top of the Launch Pad page to get more information. Online Help topics link to information in an online version of this book. Generally, topics that are displayed by selecting Help in the Oracle Access Management Console appear in only English and Japanese languages. Online Help is not translated into the ADMIN languages.

You can click the Welcome tab to display a list of topics that describe actions you can take. For specific help topics, use the following procedure.

To access online help in the Oracle Access Management Console:

1. From the Oracle Access Management Console, click a tab.
2. Click Help in the drop down menu under the user name in the upper-right corner.
3. Review the page that appears in a new window and select one of the following links:
 - **More**—Click this link to view more information.
 - **How?**—Click this link to see steps to perform a task related to your help search.
 - **Contents**—Expand Contents in the left Help pane to see all the help topics and the topics in the online manual.
 - **Search**—Click this link to enter your search criteria in the help search window.
4. Click the following buttons, as needed:
 - **View**—Displays a set of viewing options.
 - **Arrows**—Return to the previous page or go forward to the next page.
 - **Printer Icon**—Prints the page.
 - **Envelope Icon**—Sends the page through email.

2.6.3 SSO Agent Search Page

The Oracle Access Management Console provides search controls for specific elements such as Agents, Application Domains, and Resources.

Figure 2-3 is a screen shot of a Search page used for SSO Agent searches.

Figure 2-3 SSO Agent Search Page

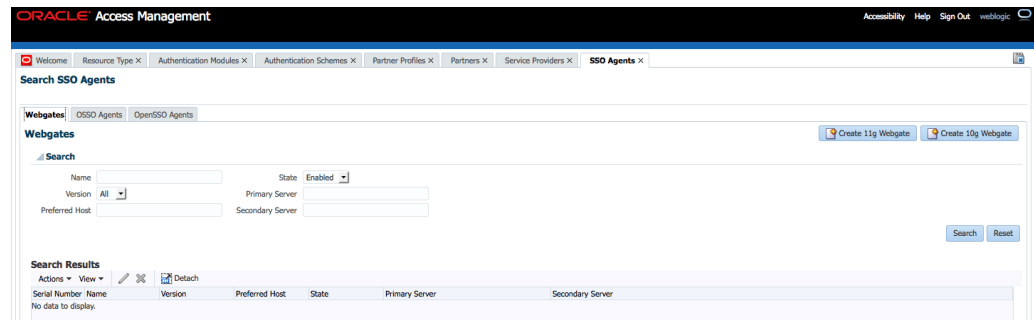

Search pages differ depending on the entity you are trying to find. In all searches, you can leave a field blank to display everything or use a wildcard (*) character if you do not know the exact name you seek. Some search controls include the ability to save your search criteria. From the search results table, you can choose an item to open for viewing or editing.

Note:

The search tool is case insensitive.

2.7 Command-Line Tools for Configuration

Several command-line tools are available to perform various tasks using the keyboard rather than the Oracle Access Management Console.

After using these commands, the configurations will be available in the console.

- Remote registration tool, `oamreg`, enables remote registration of Agents, and creation of default Application Domains.

See Also:

[OAM Agent Registration Parameters in the Console.](#)

- Upgrade Assistant (UA) enables you to transfer OSSO 10g configuration to Oracle Access Management.

See Also:

- *Oracle Fusion Middleware Upgrade Guide for Oracle Identity and Access Management*
-
-

- Oracle WebLogic Scripting Tool (WLST) provides a number of custom OAM command-line alternatives for tasks you can perform in the Oracle Access Management Console.

See Also:

WLST Command Reference for WebLogic Server

2.8 Logging, Auditing, Reporting, and Monitoring Performance

Logging is the mechanism by which components write messages to a file. These messages can be logged at different levels of granularity. Oracle Access Management components use the same logging infrastructure and guidelines as any other component in Oracle Fusion Middleware 11g. Administrators can monitor performance and log messages for Access Manager and Security Token Service using Oracle Fusion Middleware Control.

In Oracle Fusion Middleware, auditing provides a measure of accountability and answers to the “who has done what and when” types of questions. Oracle Access Management uses the Oracle Fusion Middleware Common Audit Framework to support auditing for a large number of user authentication and authorization run-time events, and administrative events (changes to the system). The Oracle Fusion Middleware Common Audit Framework provides uniform logging and exception handling and diagnostics for all audit events.

See Also:

[Logging, Auditing, Reporting and Monitoring Performance.](#)

Tuning Performance

2.9 Configuring Oracle Access Management Login Options

Oracle Access Management allows you to configure user login options like choosing a user login language, configuring forgot password URL, and many more.

The following topics describe how to configure Oracle Access Management user login options:

- [Administering the Forgot Password URL](#)
- [Choosing a User Login Language](#)
- [Understanding Persistent Login](#)

2.9.1 Administering the Forgot Password URL

When a user clicks the Forgot Password link on the Oracle Access Management login page, the user is taken to an Oracle Access Management Forgot Password page where a new password can be set in the case of a forgotten one.

The following sections contain procedures for administering the Forgot Password URL.

- [Setting a Forgot Password URL](#)

- [Retrieving a Forgot Password URL](#)

2.9.1.1 Setting a Forgot Password URL

You can set a new Forgot Password URL.

Run the following command:

```
curl --user weblogic:password
-w "%{http_code}"
-i -H
"Content-Type:application/json"
-H "Accept: */*"
-X PUT -d
'{"forgotPasswordURL":"http://oam-host:7777/identity/faces/forgotpassword"}'
```

```
http://host:7001/oam/admin/api/v1/configurationService/forgotPassword
```

If successful, the “Forgot Password URL configured successfully” message is displayed in the output. If there is already a URL set for Forgot Password, running the command overwrites the previous Forgot Password URL.

2.9.1.2 Retrieving a Forgot Password URL

You can retrieve the Forgot Password URL.

Run the following command:

```
curl --user weblogic:password
-w "%{http_code}" \
-i \
```

```
http://host:7001/oam/admin/api/v1/configurationService/forgotPassword
```

2.9.2 Choosing a User Login Language

Topics relevant to user language selection in OAM include:

- [User Login Language Code](#)
- [Selecting A Language for Oracle Access Management Login](#)
- [Language Preference Cookie](#)
- [Propagating Language Preference and Application Integration](#)

2.9.2.1 User Login Language Code

Oracle Access Management supports language selection through a drop down list of languages on the login form combined with use of the OAM_LANG_PREF language preference cookie.

[Table 2-1](#) lists the supported languages and applicable language codes.

The **Language** column refers to languages supported by the Login Pages and the **Administrators** column refers to languages supported by the Oracle Access Management Console. If the language is supported by the Login Page, simply change the browser's language and users should see a translated page.

Table 2-1 Language Codes For Login Pages

Language Code	Language	Administrators
ar	Arabic	
cs	Czech	
da	Danish	
de	German	German
el	Greek	
en	English	English
es	Spanish	Spanish
fi	Finnish	
fr	French	French
fr-CA	Canadian French	
he	Hebrew	
hr	Croatian	
hu	Hungarian	
it	Italian	Italian
ja	Japanese	Japanese
ko	Korean	Korean
nl	Dutch	
no	Norwegian	
pl	Polish	
pt-BR	Brazilian Portuguese	Brazilian Portuguese
pt	Portuguese	
ro	Romanian	
ru	Russian	
sk	Slovak	
sv	Swedish	
th	Thai	
tr	Turkish	
zh-CN	Simplified Chinese	Simplified Chinese
zh-TW	Traditional Chinese	Traditional Chinese

To accomplish a very specific login experience, implement a custom login page using the customization facilities in Oracle Access Management as described in *Oracle Fusion Middleware Developer's Guide for Oracle Access Management*.

Note:

Prior to the release of 11.1.2.1, Oracle Access Manager relied on the Browser Language preference (Accept-Language HTTP Header) to determine the language in which the login page was rendered. The default, if the language could not be determined, was English (en-us). This behavior is supported going forward until existing applications have migrated to the 11.1.2.1 model.

2.9.2.2 Selecting A Language for Oracle Access Management Login

Oracle Access Management provides the language selection methods.

[Table 2-2](#) The order of these items in the table illustrates the preference order.

You can use the `configOAMLoginPagePref` WebLogic Scripting Tool (WLST) command to configure the login page language preferences.

See the *WLST Command Reference for WebLogic Server* for information regarding this WLST command.

Table 2-2 Oracle Access Management Language Selection Methods

Method	Description
Server Override	Allows the OAM Server to determine the language. It is intended to support scenarios where the User Agent cannot reliably indicate its language preference(s) or where the administrator needs to override other selection mechanisms for operational reasons.
Preference Cookie	A domain cookie (similar to <code>ORA_FUSION_PREFS</code>) that contains the user's language preferences. It is intended to allow lang preferences maintained by an application(s) personalization facilities to be used. Note: Multiple DNS domain support for the Preference Cookie is a limitation today. The solution will include Resource Webgates using the OAM Front-Channel protocol in combination with local resource cookie enhancements to manage preference cookie semantics across DNS domains. See Also: " Language Preference Cookie "
Browser Language	Allows User Agents (Browsers, REST Clients, HTTP Clients) to specify the user's language preference via an HTTP Accept-Language header.
Default Language	Used if Oracle Access Management cannot determine the user's language preference based on the specified selection mechanisms.

Language preferences are disabled until explicitly enabled. By default, the login form does not include the list of language values until the application locales are specified.

Note:

Language Selection is only available in the ECC login page; it is not currently available in the DCC login page.

2.9.2.3 Language Preference Cookie

The language preference cookie, OAM_LANG_PREF is a domain scoped cookie as described in [Table 2-3](#).

Table 2-3 OAM_LANG_PREF Cookie

Parameters	Description
Name	OAM_LANG_PREF
Domain	Domain-scoped cookie
Path	/
Value	[<i>Cookie version</i>] [<i>separator</i>] [UTF-8 BASE64(<i>name-value pairs</i>)] For example: v1.0~kqhkIG9w0BAQQFADCB0TELM
ExpirationTime	Persistent Session (default) – Specified in OAM configuration
Secure Flag	Yes
preferredLanguage	BCP47/RFC4647. Specifically, the value space should conform to what is formally called the "language priority list".
defaultLanguageMarker	true (reconcile cookie with application maintained preferences) false (read from cookie).
Cookie Lifecycle	Oracle Access Management and other applications can perform create, read, update, and delete operations.

2.9.2.4 Propagating Language Preference and Application Integration

Oracle Access Management will propagate the language selected by the user to applications.

For more details, see [Table 2-4](#).

Table 2-4 Application Integration for Language Preference

Method	Description
HTTP Accept-Language Header	This enables application to integration without code change. This is a major advantage over the other options. We can expect this to be good for most applications that respond to the browser locale setting. This is the standard practice in internationalizing a Web application. We expect this to be able to become the standard option for all ADF based products, as well as any application that responds to browser locale. Note: OAM Agents ensure that the Accept-Language reflects the language selected. Also, ServletFilters could be used to make this happen.

Table 2-4 (Cont.) Application Integration for Language Preference

Method	Description
Access Manager Policy Response	Access Manager stores the language selection in the attribute langPref in the session namespace. For instance: <code>\$session.langPref</code> . This attribute can be passed to downstream applications using an HTTP Header and/or Cookie through the Access Manager Policy Response. The name of the Header and/or Cookie is a deployment time assignment.
Preference Cookie	When the language selected during login differs from the value stored in the Preference Cookie, Oracle Access Management will update the "preferredLanguage" parameter in the Preference Cookie with the newly selected language and set the defaultLanguageMarker parameter to "false".
IdentityContext	The language preference can be propagated as a custom claim in the IdentityContext. Select "oracle:idm:claims:session:attributes" as the claim name and then specify the session attribute using the following notation: "preferredLanguage=\$session.langPref". The claim will be created with the name of "oracle:idm:claims:session:attributes:preferredLanguage" and value equal to the session's langPref attribute.

2.9.3 Understanding Persistent Login

With Access Manager, a user needs to re-authenticate after a period of session inactivity defined by the Idle Timeout parameter (default is 15 minutes) and once the session expires, due to the value of the Session Lifetime parameter (default is 8 hours). The Persistent Login functionality offers administrators the option to skip user re-authentication for a considerably longer period of time should the user opt in - allowing a user two weeks or a month significantly improves convenience. Persistent Login (sometimes referred to as Remember Me or Keep Me Signed In) can be enabled or disabled with the period of time being configurable. It is disabled by default.

Persistent Login is enabled in the `oam-config.xml` global configuration file. The appropriate Application Domain must also explicitly allow Persistent Login. When enabled globally, the user login page will have a Keep Me Signed In checkbox and, when checked, the user receives an RMTOKEN. Once the user's session expires or times out, a user with an RMTOKEN will not be challenged if the resource is in the Application Domain that allows Persistent Login and if its authentication level is adequate. If the user tries to access a resource in an Application Domain that has not opted in, the user will be challenged for credentials even if the authentication level is adequate. (If the user does not opt in when logging in, reauthentication will be prompted after a session expiration or inactive timeout.)

Note:

If the Application Domain 'Session Idle Timeout' is specified, Persistent Login cannot be enabled.

The following behaviors are pertinent to the Persistent Login functionality.

- If enabled for the user logged in to Access Manager from a device browser, closing and reopening the browser does not require reauthentication within the defined Persistent Login time period
- Session activities will be reflected in the Audit data.
- When the time period expires, the end user is asked to authenticate again.
- When attempting to access applications from a different device (or even a different process/browser in the same device), the end user will be asked to authenticate again.
- When the user clicks log out, the OAM_RM token is deleted and they user must log in again. Session termination by an administrator will have the same effect.
- As the OAM_RM token is based on credentials entered at the time of token creation, any event that changes the password status will invalidate the token and force the user to re-authenticate. This includes:
 - Password expiration
 - Password reset by administrator
 - Password changed by the user on a different device
 - User deleted or locked by the administrator
- To address a stolen device scenario, the administrator can terminate all sessions for all devices/browsers of a user. The user will need to re-authenticate but has the option to enable Persistent Login on the login page
- Application triggered re-authentication forces the user to re-authenticate even if Persistent Login is enabled as the application is intentionally challenging the user before doing a sensitive operation.
- When a user navigates from an application which allows Persistent Login to one that does not, although the user is logged in automatically, the application which does not allow Persistent Login will challenge the user to enter credentials.
- Persistent Login is not available in application triggered login pages.

The following topics provide additional details:

- [Enabling Persistent Login](#)
- [Troubleshooting Persistent Login](#)

2.9.3.1 Enabling Persistent Login

The feature is not enabled by default.

To enable Persistent Login globally:

1. Connect to WebLogic Server using `connect()`.

Provide the username and password when prompted.

2. Run the command:

```
configurePersistentLogin(enable="true", validityInDays="30",  
maxAuthnLevel="2", userAttribute="obPSFTID")
```

3. Create a new Authentication Scheme for Persistent Login using the values in the following table.

See [Managing Authentication Schemes](#).

The 'Keep me signed in' check box will be displayed only when accessing a resource protected by this scheme.

Attribute	Value
Name	PersistentLoginScheme (or any name)
Description	any description
Authentication Level	2
Challenge Method	FORM
Challenge Redirect URL	/oam/server/
Authentication Module	LDAPPlugin
Challenge URL	/pages/login.jsp
Context Type	default
Context Value	/oam
Challenge Parameters	enablePersistentLogin=true

4. Click the Application Domains link in the Launch Pad.
5. Click the Application Domain for which you will use this PersistentLoginScheme and change its Authentication Scheme as documented in this sub procedure.
See [Defining Authentication Policies for Specific Resources](#).
 - a. Click the Authentication Policies tab in the appropriate Application Domain.
 - b. Change the Authentication Scheme for the Protected Resource Policy to PersistentLoginScheme. This allows persistent login for this policy.

Note:

The Public Resource Policy should not be modified.

6. Click the Application Domain under which you will create a Response for all configured Authorization Policies as documented in this sub procedure.
There may be multiple authorization policies and this needs to be done for all.
See [About Constructing a Policy Response for SSO](#).
 - a. Click the Authorization Policies tab in the appropriate Application Domain.
 - b. One at a time, click an Authorization Policy in this Application Domain to open its configuration tab.
 - c. Click Responses.

- d. Click Add to create an Authorization Response in the Application Domain.
- e. Enter the following values in the displayed Add Response pop-up and click Add.

Attribute	Value
Type	Session
Name	allowPersistentLogin
Value	true

NOTE: To disable Persistent Login for an Application Domain you must disable Authorization Responses by changing the value of the Value attribute in the Add Response pop-up to *false*.

- i. Go to "Conditions" tab.
- ii. Click Add. Provide Name=TRUE, Type=TRUE.
- iii. Click Add Selected.
- iv. Go to "Rules" tab.
- v. In the "Allow Rule" section move the condition TRUE (true) from "Available Conditions" to "Selected Conditions" section.
- vi. Click Apply.

Perform this procedure for all Authorization Policies before moving on to the next step.

- 7. Access a resource protected by this scheme.

The 'Keep me signed in' checkbox is displayed on the login page.

- 8. Provide valid credentials and select 'Keep me signed in'.
- 9. Close and re-open the browser.
- 10. Access the same resource.

You will be logged in automatically without asking for credentials.

Note:

Persistent Login can also be enabled and disabled using WLST. See the *WLST Command Reference for WebLogic Server* for details on the `configurePersistentLogin` command.

2.9.3.2 Troubleshooting Persistent Login

When enabling Persistent Login using WLST, an LDAP attribute named `obpsftid` is defined to store the Persistent Login properties. When the user is locked, the `obpsftid` attribute needs to be updated but the `oamSoftwareUser` does not have sufficient LDAP rights over it.

To give `oamSoftwareUser` permission:

1. Copy the LDIF data below and paste it into a file that you will save as `oam_user_write_acl_users_obpsftid_template.ldif`.

```
#####
# Copyright (c) 2010, 2011, Oracle and/or its affiliates. All rights reserved.
#
# NAME: idm_idstore_groups_acl_template.ldif
#
# DESCRIPTION:
#
# This file provides appropriate ACLs to user and group containers.
#
#
# SUBSTITUTION VARIABLES:
#
# %s_UsersContainerDN% : The container in which users reside
# %s_GroupsContainerDN% : The container in which groups reside
#
#####
dn: %s_UsersContainerDN%
changetype: modify
delete: orclaci
orclaci: access to attr=(obUserAccountControl, obLoginTryCount, obLockoutTime,
oblastsuccessfullogin, oblastfailedlogin, obpasswordexpirydate, obver,
obLastLoginAttemptDate, oblockedon) by group="cn=orclFAOAMUserWritePrivilegeGroup,
%s_GroupsContainerDN%" (search,read,compare,write) by
group="cn=orclFAUserReadPrivilegeGroup,%s_GroupsContainerDN%"
(search,read,compare) by group="cn=orclFAUserWritePrivilegeGroup,
%s_GroupsContainerDN%" (search,read,compare,write)
-
add: orclaci
orclaci: access to attr=(obUserAccountControl, obLoginTryCount, obLockoutTime,
oblastsuccessfullogin, oblastfailedlogin, obpasswordexpirydate, obver,
obLastLoginAttemptDate, oblockedon, obpsftid) by
group="cn=orclFAOAMUserWritePrivilegeGroup,%s_GroupsContainerDN%"
(search,read,compare,write) by group="cn=orclFAUserReadPrivilegeGroup,
%s_GroupsContainerDN%" (search,read,compare) by
group="cn=orclFAUserWritePrivilegeGroup,%s_GroupsContainerDN%"
(search,read,compare,write)
```

2. Do the following in the created `oam_user_write_acl_users_obpsftid_template.ldif`.
 - Replace `%s_UsersContainerDN%` with User Search Base.
 - Replace `%s_GroupsContainerDN%` with Group Search Base.
3. Change to the OID directory and run `ldapmodify`.

```
$ setenv ORACLE_HOME <OID_INSTALL_LOCATION>
$ cd $ORACLE_HOME/bin
$ ./ldapmodify -h <LDAP server> -p <LDAP port> -D <bind DN> -w <bindpassword>
-v -f oam_user_write_acl_users_obpsftid_template.ldif
```

Part II

Managing Common and System Configurations

Administrators set common properties for the services integrated into Access Manager, administer data sources, register managed server instances and grant responsibilities to other Administrators.

You can manage common system-wide configuration details for Oracle Access Management . This section contains the following chapters:

- [Managing Common Services and Certificate Validation](#)
- [Delegating Administration](#)
- [Managing Data Sources](#)
- [Managing Server Registration](#)

Managing Common Services and Certificate Validation

The properties that are used in common can be configured by the services integrated into Oracle Access Management.

This chapter contains the following sections:

- [Configuration Options in Oracle Access Management Console](#)
- [Available Services of the Common Configuration Section](#)
- [Common Settings](#)
- [Certificate Validation and Revocation](#)

3.1 Configuration Options in Oracle Access Management Console

This section introduces the Oracle Access Management options and settings collectively called Configuration. Unless explicitly stated, the Configuration options are shared by all Access Manager servers and services in the domain.

[Figure 3-1](#) shows the Configuration options defined in the new Oracle Access Management Console. You can access these settings by clicking **Configuration** at the top of the Console.

Figure 3-1 Oracle Access Management Configuration Options

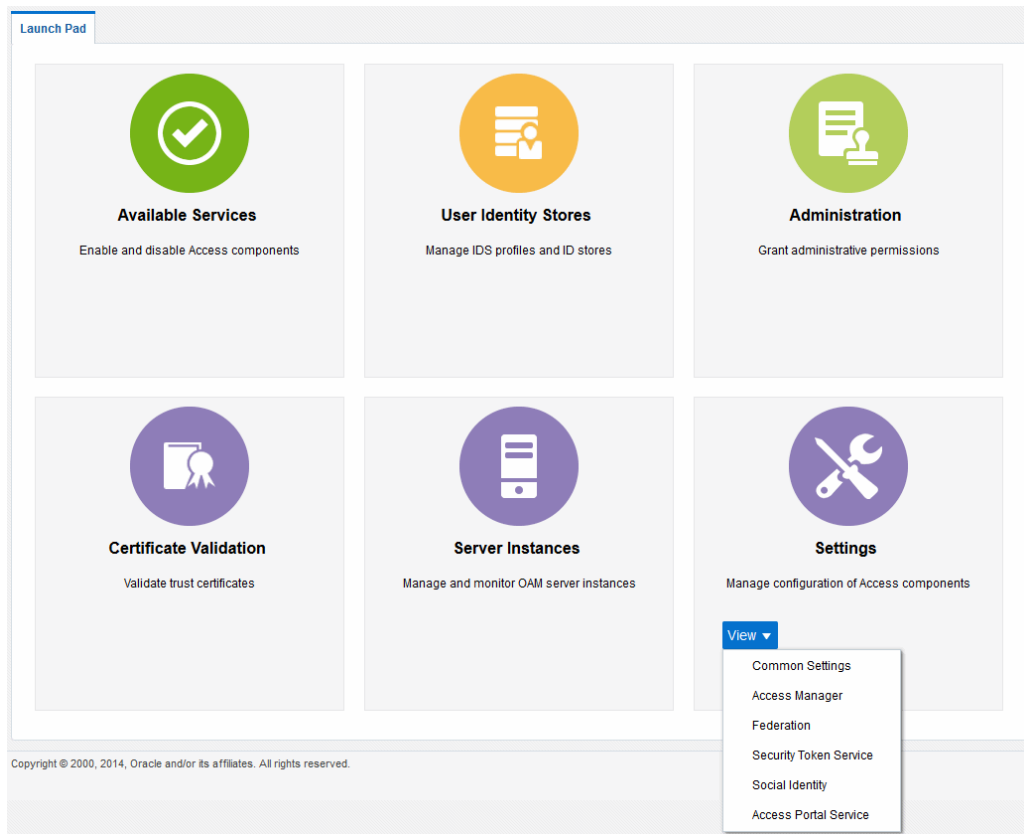

Table 3-1 describes the Configuration options. The items listed apply to all services in the suite.

Table 3-1 Configuration Options

Node	Description
Available Services	See " Available Services of the Common Configuration Section ".
User Identity Stores	See " Registering and Managing User Identity Stores " in Managing Data Sources .
Administration	See Delegating Administration .
Certificate Validation	Provides access to the certificate revocation list and OCSP/CDP settings. See: " Certificate Validation and Revocation ".
Server Instances	Provides access to all registered OAM Server instances. See: Managing Server Registration

Table 3-1 (Cont.) Configuration Options

Node	Description
Settings > Common Settings	Provides configurations that apply to all Oracle Access Management services including Session properties, Oracle Coherence, Auditing, and Default and System Identity Stores. See: " Common Settings ".
Settings > Access Manager	Provides access to Access Manager operation configurations. See " Managing Common and System Configurations "
Settings > Social Identity	Provides access to configurations for the Social Identity features of Oracle Access Management Mobile and Social. See " Managing Oracle Access Management Mobile and Social "
Settings > Federation	Provides access to configurations for Oracle Access Management Identity Federation. See Managing Identity Federation Partners , Managing Settings for Identity Federation and Managing Federation Schemes and Policies .
Settings > Security Token Service	Provides access to configurations for Oracle Access Management Security Token Service. See " Managing Oracle Access Management Security Token Service "
Settings > Access Portal Service	Provides access to configurations for Oracle Access Portal. See " Managing Oracle Access Management Oracle Access Portal "

3.2 Available Services of the Common Configuration Section

Available Services shows the Available Services page of the Common Configuration section, which provides the status of services, and controls to enable or disable a service. Initially, only Access Manager services are enabled.

Oracle Access Management Administrators must enable a service in the Oracle Access Management Console to use the related functionality. The exception to this is Identity Context, which is enabled by default and does not have any controls to disable it.

Figure 3-2 Available Services

The screenshot shows the 'Available Services' configuration page. At the top, there's a breadcrumb 'Configuration >' and the title 'Available Services'. Below the title, a note states: 'The following is the list of services installed in your current deployment. Disabling a service will only turn off that service and will not uninstall it from the system.' The services are organized into three main sections:

- Application Security:**
 - Access Manager: Status: Enabled (Green checkmark), Button: Disable Service
 - Adaptive Authentication Service: Status: Enabled (Green checkmark), Button: Disable Service
- Federation:**
 - Identity Federation: Status: Enabled (Green checkmark), Button: Disable Service
 - Security Token Service: Status: Enabled (Green checkmark), Button: Disable Service
 - Access Portal Service: Status: Enabled (Green checkmark), Button: Disable Service
- Mobile:**
 - Mobile and Social: Status: Enabled (Green checkmark), Button: Disable Service
 - Mobile Security Service: Status: Enabled (Green checkmark), Button: Disable Service

A green check mark in the Status field beside the service name indicates the service is enabled. A red circle with a cross through it indicates that the corresponding service is disabled.

Table 3-2 Common Services

Service	Description
Access Manager	Access Manager functionality is enabled by default. Access Manager Service is required to set SSO policies, configure Access Manager, as well as Common Configuration, and when REST Services are enabled. Default: Enabled No other services are required for Access Manager and Common Configuration.
Adaptive Authentication Service	Required for adaptive authentication functionality. Default: Enabled See Also: Managing the Adaptive Authentication Service and Oracle Mobile Authenticator.

Table 3-2 (Cont.) Common Services

Service	Description
Identity Federation	<p>Must be enabled to manage the federation partners.</p> <p>Default: Disabled</p> <p>Note: The Access Manager service must also be enabled because Identity Federation is another authentication module.</p> <p>See Also: Managing Oracle Access Management Identity Federation.</p>
Security Token Service	<p>Enable this service to use Security Token Service functionality.</p> <p>Default: Disabled</p> <p>Access Manager service is not required.</p> <p>See Also: Managing Oracle Access Management Security Token Service.</p>
Access Portal Service	<p>Must be enabled to manage the Access Portal Service.</p> <p>Default: Disabled</p> <p>See Managing Oracle Access Management Oracle Access Portal</p>
Mobile and Social	<p>Mobile and Social Services can be deployed in either of two ways:</p> <ul style="list-style-type: none"> • As part of Oracle Access Management, where Access Manager is enabled by default and Mobile and Social must be enabled manually to operate together with Access Manager. • Oracle Access Management and Mobile and Social only. Here only Mobile and Social is enabled by default to work on its own (or use a remote Access Manager). <p>See Also: Managing Oracle Access Management Mobile and Social</p>
Mobile Security Service	<p>Required for mobile security functionality, which governs secure access to mobile applications and devices. This includes features like Mobile Security Manager, Mobile Security Access Server, Mobile Authentication and Mobile OAuth Services.</p> <p>Default: Enabled</p> <p>See Also: Managing Oracle Access Management Mobile and Social</p>

3.2.1 Enabling or Disabling Available Services

The WebLogic AdminServer and OAM Server must be running to enable or disable an available service.

(For details, see [Starting and Stopping Servers in Your Deployment](#)).

1. From the Oracle Access Management Console Launch Pad, click **Available Services** under Configuration.
2. Click **Enable** beside the desired service name (or confirm that the Status check mark is green).
3. Click **Disable** beside the desired service name (or confirm that the Status check mark is red).

3.3 Common Settings

Common Settings apply to all services within the suite.

[Figure 3-3](#) shows the named sections on the Common Settings page, which can be expanded to reveal related elements and values.

Figure 3-3 Common Settings Page (Collapsed View)

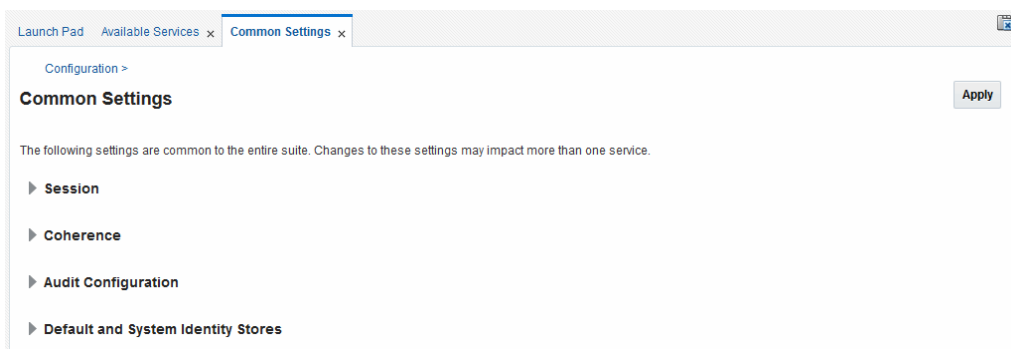

Oracle Access Management Administrators can control and specify parameters used by the entire suite, not just a single service, as introduced in [Table 3-3](#).

Table 3-3 Common Settings

Tab Name	Description
Session	Session configuration refers to the process of managing the lifecycle requirements of a session, and notification of events to enable global logout. Global logout is required for OSSO Agents (mod_osso) to ensure that logging out of a session on any entity propagates the logout to all entities.
Coherence	Common Oracle Coherence settings shared by all OAM Servers differ from those for individual OAM Servers. However, in both cases Oracle recommends that you make no adjustments to these settings unless instructed to do so by an Oracle Support Representative.
Audit Configuration	Oracle Access Management supports auditing for a large number of administrative and run-time events, uniform logging and exception handling, and the diagnostics of all audit events. Oracle Access Management auditing configuration is recorded in <code>oam-config.xml</code> . See Also: " Using the Oracle Access Management Console for Audit Configuration ".
Default and System Identity Stores	This section identifies the default identity and system stores, which can be one in the same (or different).

See Also:

Details for other operations common to all OAM components:

- [Logging Component Event Messages](#)
 - [Monitoring Oracle Access Management Performance and Access Manager Health](#)
-
-

The following sections have more information.

- [Managing Common Settings](#)
- [Viewing Common Coherence Settings](#)

3.3.1 Managing Common Settings

Users with valid Oracle Access Management Administrator credentials can perform the following task to display the Common Settings page and perform changes. To manage common settings, the OAM Server must be running.

(For details, see [Starting and Stopping Servers in Your Deployment](#).)

1. At the top of the Console, click **Configuration**.
2. In the Configuration Launch Pad, select **Common Settings** from the **View** menu in the **Settings** section.
3. **Session:**
 - a. On the Common Settings page, expand the **Session** section.
 - b. Click the arrow keys beside each list to increase or decrease session lifecycle settings as needed:
 - Session Lifetime (minutes)
 - Idle Timeout (minutes)
 - Maximum Number of Sessions per User
 - c. Database Persistence: Check the box to enable Database Persistence for Active Sessions (or clear it to disable Database Persistence).
 - d. Click **Apply** to submit your changes.
 - e. See Also: [Maintaining Access Manager Sessions](#).
4. **Coherence:** See "[Viewing Common Coherence Settings](#)".
5. **Audit Configuration:**
 - a. Expand the Audit Configuration section.
 - b. In the Audit Configuration section, enter appropriate details for your environment:
 - Maximum (Log) Directory Size
 - Maximum (Log) File Size

Filter Enabled

Filter preset (select from the list to define verbosity of audit data)

Audit Configuration Table: Use Add (+) or Delete (x) buttons to specify users.

- c. Click **Apply** to submit the Audit Configuration (or close the page without applying changes).
 - d. See Also: [Auditing Administrative and Run-time Events](#).
6. **Default Store and System Stores:**
- a. Expand the **Default and System Identity Stores** section.
 - b. Click the name of the System Store (or Default Store) to display the configuration page.
 - c. See [About using the System Store for User Identities](#) for more information.

3.3.2 Viewing Common Coherence Settings

You can expand and view the Coherence settings.

To view:

1. At the top of the Console, click **Configuration**.
2. In the Configuration Launch Pad, select **Common Settings** from the **View** menu in the **Settings** section.
3. On the Common Settings page, expand the **Coherence** section.
4. Close the page when you finish; do not make any changes.

[Figure 3-4](#) shows the Common Settings page with the Coherence section expanded.

Figure 3-4 Common Coherence Settings

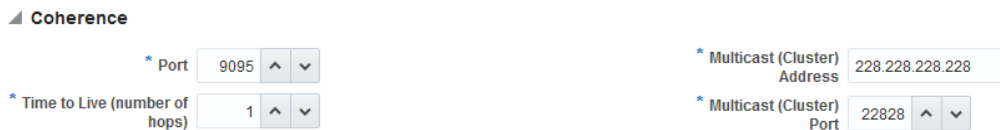

[Table 3-4](#) describes these settings.

Note:

Oracle strongly recommends that you do not alter these settings without the assistance of Oracle Support.

Table 3-4 Common Coherence Settings

Element	Description
Port	Value between 1 and 65535 is supported.

Table 3-4 (Cont.) Common Coherence Settings

Element	Description
Multicast (Cluster) Address	Value between 224.1.255.0 to 239.255.255.255 is allowed.
Time to Live (number of hops)	Value between 0 and 255 is supported.
Multicast (Cluster) Port	Value between 1 and 65535 is supported.

3.4 Certificate Validation and Revocation

The Certificate Validation module is used by the Security Token Service to validate X.509 tokens and to verify whether or not the certificates have been revoked.

It supports the following options:

- A Certificate Revocation List (CRL) is a list of certificates (identified by serial numbers) that have been revoked. Revoked certificates are listed with a reason, an issue date, and the issuing entity. (In addition, each list contains a proposed date for the next release.) Entities presenting these (revoked) certificates should no longer be trusted. When a potential user attempts to access a server, the server allows or denies access based on the CRL entry for the particular user. For more information, see [Enabling the Certificate Revocation List Functionality](#)
- The Online Certificate Status Protocol (OCSP) was developed as an alternative to CRLs. OCSP specifies how the client application that requests information on a certificate's status will obtain it from the server that responds to the request. An OCSP responder can return a signed response signifying that the certificate specified in the request is either *good*, *revoked* or *unknown*. If the OCSP cannot process the request, it returns an error code. For more information, see "[Enabling OCSP Certificate Validation](#)" and [Additional OCSP Configurations](#)
- A CRL Distribution Point extension (CDP extensions) contains information regarding the location of Certificate Revocation Lists (CRLs) and OCSP servers. You can use the Administration Console to define these points. For more information, see [Enabling CRL Distribution Point Extensions](#)

3.4.1 Enabling the Certificate Revocation List Functionality

Users with Oracle Access Management Administrator credentials can use the following procedure to enable the CRL functionality and import a current Certificate Authority Certificate Revocation List (CA CRL). Before beginning, you should have your CA CRL ready to import.

To enable:

1. In the Configuration Launch Pad section of the Oracle Access Management Console, click **Certificate Validation**.

The Certificate Revocation List tab is displayed.

2. Confirm that the Enabled box is checked.
3. Add or remove a CRL.

- **Add:** Click the Add (green plus sign) button, browse for the CRL file, select it, and click Import.
- **Remove:** Click the name of the list in the table, click the Delete (x) button, and confirm when asked.

Figure 3-5 is a screenshot of the pop-up window used to add a CA CRL to the CRL List using the Administrative Console.

Figure 3-5 Certificate Revocation List Dialog Box

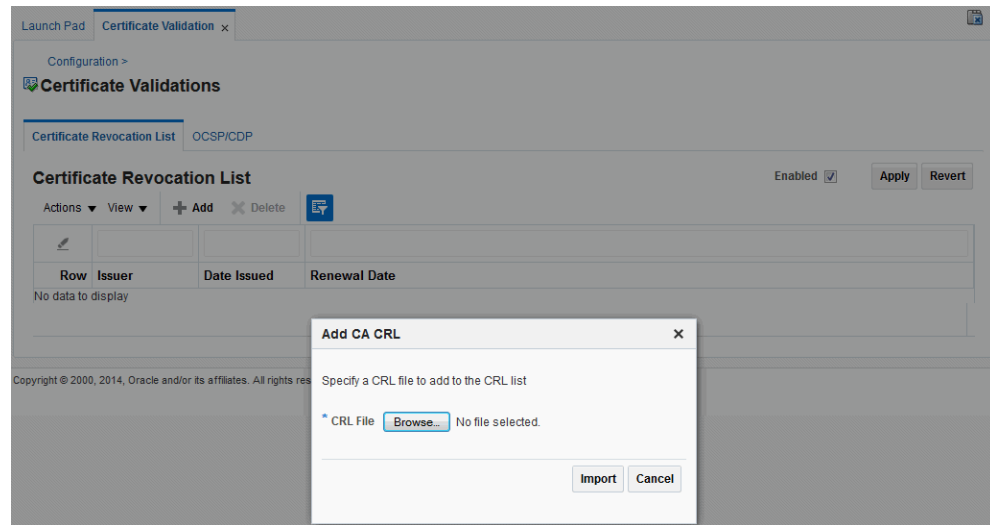

4. Click **Apply** to save the configuration.
5. Proceed to "[Enabling OCSP Certificate Validation](#)".

Note:

To search for CRLs in the table, enable Query by Example from the View drop-down. Enter filter strings in the header fields displayed and hit Enter.

3.4.2 Enabling OCSP Certificate Validation

Users with Oracle Access Management Administrator credentials can use the following procedure to enable the OCSP. Before you begin, you should have the URL of the OCSP service ready to import.

To enable:

1. Under the Configuration section of the Oracle Access Management Console, click Certificate Validation.
The Certificate Revocation List page is displayed. Confirm that the Enabled box is checked.
2. Click the OCSP/CDP tab.
 - a. Enable OCSP.
 - b. Enter the URL of the OCSP Service.

- c. Enter the Subject DN of the OCSP Service.
- d. Save this configuration.

Figure 3-6 illustrates how to add an OCSP URL using the Administration Console. See "WLST configureOAMOCSPCertValidation" for details on how to do this using the WLST command.

Figure 3-6 OCSP/CDP Settings

3. Proceed to "Enabling CRL Distribution Point Extensions".

3.4.3 Enabling CRL Distribution Point Extensions

Users with Oracle Access Management Administrator credentials can use the following procedure to add CRL distribution points in issued certificates.

To enable:

1. Under the Configuration section of the Oracle Access Management Console, click Certificate Validation.
The Certificate Revocation List page is displayed. Confirm that the Enabled box is checked.
2. Open the OCSP/CDP tab.
 - a. Enable CDP.
 - b. Save this configuration.

Figure 3-6 illustrates this.

3.4.4 Additional OCSP Configurations

Support for HTTP Proxy and multiple OCSP Responder configurations have been added for this 11g Release 2 (11.1.2.3) version of Oracle Access Manager.

The following example illustrates the current Certificate Validation Module configuration.

Certificate Validation Module Configuration

```
<Setting Name="CertValidationModule" Type="htf:map">
  <Setting Name="certpathvalidationocspcertsubject"
    Type="xsd:string"></Setting>
  <Setting Name="certpathvalidationocspurl" Type="xsd:string"></Setting>
  <Setting Name="certvalidationcrlstorelocation"
```

```

        Type="xsd:string"/>/scratch/maymaria/installed/wlsHome/user_projects/
        domains/base_domain/config/fmwconfig/amcrl.jar</Setting>
    <Setting Name="defaulttrustcastorelocation"
        Type="xsd:string"/>/scratch/maymaria/installed/wlsHome/user_projects/
        domains/base_domain/config/fmwconfig/amtruststore</Setting>
    <Setting Name="defaulttrustcastoretype" Type="xsd:string">jks</Setting>
    <Setting Name="certpathvalidationcdpenabled"
        Type="xsd:boolean">>false</Setting>
    <Setting Name="certpathvalidationcrlenabled"
        Type="xsd:boolean">>false</Setting>
    <Setting Name="certpathvalidationocspenabled"
        Type="xsd:boolean">>false</Setting>
</Setting>

```

The following sections contain configuration information for these new features.

- [WLST updateHTTPProxyConfig](#)
- [WLST configureOAMOSCSPCertValidation](#)
- [Configuring Multiple OCSP Responders](#)

3.4.4.1 Configuring Multiple OCSP Responders

Certificate authentication currently supports authentication against a single OCSP responder as documented in "[Enabling OCSP Certificate Validation](#)". Support for multiple OCSP responders has been added since the responder URL is now part of the certificate's Authority Information Access Extension.

To support multiple OCSP Responders, the three lines of configuration from the following example of Multiple OCSP Responder Configuration must be added to the top of the Certificate Validation Module configuration section (illustrated in the following example).

Multiple OCSP Responder Configuration

```

<Setting Name="CertValidationModule" Type="htf:map">
    <Setting Name="certpathvalidationocspurltocamap" Type="htf:map">
        <Setting Name="url_value" Type="xsd:string">
            <ocsp_responder_subject></Setting>
        </Setting>
    <Setting Name="useJDKOCSP" Type="xsd:string">>false</Setting>
    ...
</Setting>

```

Configure the first and second lines to enable multiple OCSP responders.

- Set `certpathvalidationocspenabled` to true.
- Update the `certpathvalidationocspurltocamap` configuration. It is of type Map, the key is the OCSP Responder URL (URL Encoded) and the value is the OCSP Responder's Certificate subject.

```

<Setting Name="certpathvalidationocspurltocamap" Type="htf:map">
    <Setting Name="http%3A%2F%2Flocalhost%3A9797" Type="xsd:string">
        emailAddress=sagar@pspl.com,CN=ps2436,OU=OBLIX-QA,O=PSPL,
        L=PUNE,ST=MAHA,C=MY</Setting>
</Setting>

```

- (Optionally) set values for `certpathvalidationocspcertsubject` and `certpathvalidationocspurl`.

The Responder URLs will be fetched first from the AuthorityInformationAccess extension of the user's X.509 certificate and second from Modules/Plugin (CertValidation). The Responder Subjects will be fetched first from the defined configuration map and second from the Module/Plugin (CertValidation) configuration. In cases where these configurations are not found, the OCSP validation will fail.

Configure the third line to provide backward compatibility for those who want to use JDK OCSP validation rather than the new OAM OCSP Checker. By default, the JDK OCSP Checker is enabled. When configuring the OAM OCSP Checker using the WLST command, the flag is set to false. For more information on the WLST command, see [WLST configureOAMOCSPCertValidation](#).

Depending on the Certificate Validation Module configuration there are three different options as documented in [Table 3-5](#).

Table 3-5 OCSP Responder Configuration Options

Configuration	OCSP Configuration (certpathvalidationocspenabled)	CRL Configuration (certpathvalidationcrlenabled)	JDK/OAM OCSP Configuration (useJDKOCSP)
No OCSP Checking Simple certificate validation is performed during OAM X-509 authentication	False	False	False
OAM OCSP X-509 authentication performs certificate validation with OCSP checking using the new OAM OCSP Checker.	True	True/False (does not matter)	False
JDK OCSP X-509 authentication performs certificate validation with OCSP checking using the JDK OCSP Checker.	True	True	True

To enable OCSP validation to be done using one configured responder URL, set the certpathvalidationcrlenabled and certpathvalidationocspenabled properties to true and set values for the certpathvalidationocspcertsubject and certpathvalidationocspurl properties. If these properties are not set, OCSP validation will be done using the responder URL defined within the user certificate's AIA Extension. If no URL is defined, OCSP validation will fail.

3.5 WLST updateHTTPProxyConfig

The Oracle Access Manager OCSP checker can perform authentication against OCSP responders that are outside an enterprise's intranet through HTTP Proxy.

Use the `updateHTTPProxyConfig` WLST command to configure the OAM OCSP checker to use HTTP proxy.

Description

Adds or updates proxy information.

Syntax

```
updateHTTPProxyConfig(proxyHost, proxyPort, conTimeOut)
```

Argument	Definition
<i>proxyHost</i>	Mandatory. The host name of the proxy.
<i>proxyPort</i>	Mandatory. The port number of the proxy.
<i>conTimeOut</i>	Mandatory. The connection timeout in milliseconds.

Example

```
updateHTTPProxyConfig(proxyHost="hostname.example.com", proxyPort="8888",
    conTimeOut="600")
```

3.6 WLST configureOAMOSCSPCertValidation

You can use the `configureOAMOSCSPCertValidation` online command to update the OAM OCSP configuration.

It includes the following:

- Updating or adding an OCSP responder URL and subject details to the "certpathvalidationocspurltocamap"
- Clearing the newly added configuration; for example, "certpathvalidationocspurltocamap"
- Setting or unsetting the "useJDKOCSP" flag to enable or disable JDK OCSP

Description

Updates the OAM OCSP configuration by adding/modifying the OCSP responder URL and subject details in the `certpathvalidationocspurltocamap` property and enabling/disabling the use of the JDK OCSP Checker.

Syntax

```
configureOAMOCSPCertValidation(url, subject, clear (optional),
    display (optional), useJDKOCSP (optional))
```

Argument	Definition
<i>url</i>	Mandatory. Takes as a value the valid URL.
<i>subject</i>	Mandatory. Takes the details being modified.
<i>clear</i>	Optional. Takes a value of true or false.
<i>display</i>	Optional. Takes a value of true or false.
<i>useJDKOCSP</i>	Optional. Takes a value of true or false.

Examples

The following example enables the OAM OCSP and sets the Responder URL and subject.

```
configureOAMOCSPCertValidation(url="http://sample:9898",
    subject="cert-subject-detail")
```

The following example enables the OAM OCSP and updates the Responder URL and subject.

```
configureOAMOCSPCertValidation(url="http://sample:9898",
    subject="details changed/updated")
```

The following example disables and clears the OAM OCSP.

```
configureOAMOCSPCertValidation(url="http://sample:9898", subject="subject-detail",
    clear="true")
```

The following example enables/disables the JDK OCSP.

```
configureOAMOCSPCertValidation(url="http://sample:9898",
    subject="details changed/updated", useJDKOCSP="true")
```

Delegating Administration

Delegating administration allows a high-level administrator to grant responsibilities to other, more local administrators. This is useful in large organizations where it may be necessary to administer thousands or millions of users. With this release of Oracle Access Management, a System Administrator can delegate administration of Application Domains to other administrators. An Application Domain Administrator role has been developed towards the end.

The following topics provide an overview of delegating administration, such as determining what rights you want to grant to another user:

- [Understanding Administrator Roles](#)
- [About Delegating the Identity Store](#)
- [Assigning Roles Using the Administration Console](#)
- [Understanding the Container Security Framework and MBeans](#)
- [Using the Remote Registration Utility](#)
- [About Auditing Reports](#)

4.1 Understanding Administrator Roles

After you complete the installation, Access Manager has a set of pre-defined roles that you can assign to administrators, such as the Access Manager System Administrator.

See [About Oracle Access Management Administrators](#).

You can assign the following to Access Manager system administrators:

- All Application and component policy objects (including Resources, Authentication Policies, Authorization Policies, and Token Issuance Policies)
- Shared components (including Authentication Schemes, Host Identifiers, and Resource Types)
- System configuration (including Common Configuration, Access Manager settings and Authentication Modules, Security Token Service Settings, Custom Tokens, Endpoints, Templates and Profiles, and Access Manager Agents and Security Token Service Partners)
- Agents and partners

A System Administrator can grant the rights to administer an Application Domain to an Application (Domain) Administrator. (A virtual Access Manager Administrator group is defined and mapped to the Application Administrator role.) An Application Administrator can further delegate the rights to administer one or more of their Application Domains to other Application Administrators. An Application

Administrator can create and edit Resources, Authentication Policies and Authorization Policies. These rights are scoped to one or more Application Domains.

Note:

Only the System Administrator can assign roles to users; users cannot further delegate that role to others.

The System Administrator, Application Administrator and Help Desk Administrator roles are mutually exclusive; that is, a group or user can be assigned to only one such administrator role. However, the Application Administrator and Agent Administrator roles can be assigned to the same user or group.

[Table 4-1](#) documents details about the pre-defined administrator roles.

Table 4-1 Roles for Delegating Administration

Role Name	Description
System Administrator	<p>Access to entire Oracle Access Management Console including policy creation and system configuration; encompasses the privileges to manage all system configurations, policy objects, Access Manager Settings, Agents, Authentication Modules, Authentication Schemes, Host Identifiers, Resource Types, Federation Partners and Enterprise Single Sign-on policies. Additionally, Security Token Service Settings, Partners, Custom Tokens, Endpoints, Templates and Profiles can be managed.</p> <p>NOTE: The System Administrator does not support seamless failover. If one server goes offline, the System Administrator can re-login and continue on the other server(s) in the cluster.</p>
Application Administrator	<p>Access to policy creation and resources in the specified Application Domain. This role has access to the Application Registration Quick Wizard link.</p>
Help Desk Administrator	<p>Access to the Help Desk console.</p>
Agent Administrator	<p>Access to the Agent configuration pages. This role has access to the Agent Registration Quick Wizard link.</p>
Authenticated User	<p>Access to the Self Service Launch Pad and pages.</p>

See [Oracle Access Management Console and the Policy Manager Console](#).

See [Understanding the Oracle Access Management Console](#).

4.2 About Delegating the Identity Store

The Access Manager System Identity Store is used to enforce authentication and authorization during the execution of administrative operations.

The LDAP Directory defined as the System Identity Store will contain all the administrators having access to the Administration Console. An administrator can define a new User Identity Store and select one of the existing profiles as the System

Identity Store but only the System Administrator can modify the current System Identity Store or switch to a new one.

When migrating to a new Identity Store, if users from the new store are assigned Access Manager roles, those privileges become active and are enforced by Access Manager. The administrator will be responsible for removing any delegated administration privileges for the new Identity Store and the Access Manager Administrator group will be mapped to the Administrator role of the new identity store.

Note:

If the user currently logged in does not have the necessary administrator roles in the new system store, the Administration Console will log out or refresh so that it is compliant with the roles assigned to the current administrator.

4.3 Assigning Roles Using the Administration Console

The System Administrator can use the Oracle Access Management Console to assign roles to users or groups that cover specific Application Domains. Users can be assigned multiple roles as long as the functionality doesn't overlap.

For example, if user X is assigned Global Policy Administrator, the user cannot be granted Policy Administrator for the HR domain because the latter is a child of the former.

Note:

Roles can be assigned only to users or groups from the system/default store.

From a high level:

1. When delegating administration for a specific policy object or a set of policy objects, the delegator selects the item(s) and assigns the user(s), group(s), LDAP Search Filter(s) or Domain System role(s) to it.
2. When delegating administration for all objects of a specific type, the delegator will select the user(s), group(s), LDAP Search Filter(s) or Domain System role(s) and grant the rights to administer the objects of that type to the selected. In this case, the administrator can't select objects for which administration is being delegated; the administrator will select a role that is granted to the appropriate delegatee with a specific right.

Note:

Customers using Oracle Identity Manager (or Oracle Identity Manager XE) may want to define Enterprise Roles that are common to all of IDM and use OIM to assign users and groups to these Enterprise Roles. The Administration Console allows for this.

4.4 Understanding the Container Security Framework and MBeans

MBeans that enforce authentication and authorization using the container security framework are published using the Portable JMX Framework.

Types of MBeans:

- The Configuration Service MBeans are used for configuring the Certificate Validation Module, the STS Endpoints, Templates & Profiles, and the STS Settings & Custom Tokens.
- The Partner and Trust Store Service MBeans are used for managing the STS Partners.

At runtime, the JMX Framework will authenticate the client during the connection operation and ensure that the client belongs to the role specified in the MBean security annotations. Because of this, the Access Manager System Identity Store needs to be configured as an Authentication Provider in the security realm of the domain. Additionally, users accessing the MBeans will need to be assigned the following role depending on the container:

- WebLogic: Admin
- WebSphere: Admin or Configurator

4.5 Using the Remote Registration Utility

The Remote Registration Utility (RREG) is also governed by the roles assigned to the user invoking them. When using RREG to remotely register agents, the administrator provides credentials that allows the RREG client to successfully connect and authenticate to the RREG Access Manager Server, this in turn, propagates the client's identity to the Access Manager components that will enforce the appropriate administration roles.

The following might occur when running the RREG based on the administrator's role:

- In a creation operation:
 - A new agent entry can be provisioned.
 - A HostID for that Agent can be created.
 - An Application for that agent might be created.
 - Resources might be added to the new Application using the newly created HostID.
- In an update operation:
 - Agent settings can be changed.
 - A HostID for that agent can be changed.
 - An Application for that agent can be created if it does not exist.
 - Resources can be added to the Application.

The RREG administrator must be assigned roles to ensure successful completion of the administrative operations.

- The System Administrator role to create/update an Agent.
- The OAM Shared Component Administrator / System Administrator role to create/update an HostID entry.

- The OAM Domain Administrator role / System Administrator to create/update an Application and create/configure Resources.

After executing the RREG command, the administrator will be set as the delegated administrator for the created Application, Agent and HostID.

4.6 About Auditing Reports

Auditing becomes even more critical when administration has been delegated to several users. All policy object and system configuration operations performed by administrators through the Administration Console or programmatically are logged and informational reports can be generated.

See [Introduction to Oracle Fusion Middleware Auditing](#).

Managing Data Sources

The term *data source* is a Java Database Connectivity (JDBC) term used within Oracle Access Management to refer to a collection of user identity stores or a database for policies. These data sources must be registered using the Oracle Access Management Console in order to be accessed.

The following topics describe the tasks to register and administer data sources using the Oracle Access Management Console. The information is common to all services available through the Oracle Access Management Console.

- [Data Sources for Oracle Access Management](#)
- [Registering and Managing User Identity Stores](#)
- [Managing the Identity Directory Service User Identity Stores](#)
- [Managing Administrator Roles](#)
- [Managing the Policy and Session Database](#)
- [Introduction to Oracle Access Management Keystores](#)
- [Integrating a Supported LDAP Directory with Oracle Access Manager](#)

5.1 Data Sources for Oracle Access Management

Oracle Access Management supports several types of data sources that are typically installed for the enterprise.

[Table 5-1](#) describes each data source as a storage container for the various types.

Table 5-1 Data Sources for Oracle Access Management

Data Source	Description
Database	<p>A collection of information that is organized and stored so that its content can be easily accessed, managed, and updated.</p> <ul style="list-style-type: none"> Access Manager policy data, including password management data, must be stored in a database that is extended with the Access Manager-specific schema and registered with Access Manager. See Managing the Policy and Session Database . Session Store: By default, Access Manager session data is stored within in-memory caches that is migrated to the policy store. In production environments, you can have an independent database for policy data and another for session data. For details about sessions and session data, see Maintaining Access Manager Sessions. Audit Store: Audit data can be stored either in a file or in a separate database (not the policy store database). For information on auditing administrative and run time events, see Auditing Administrative and Run-time Events.
User Identity Store	<p>Central LDAP storage in which an aggregation of user-oriented data is kept and maintained in an organized way. (Access Manager does not include identity services; there is no native user, group, or role store.) The identity store must be installed and registered with Access Manager to enable authentication when a user attempts to access a protected resource (and during authorization, to ensure that only authorized users can access a resource). During the initial deployment process, described in the <i>Oracle Fusion Middleware Installation Guide for Oracle Identity and Access Management</i>, the embedded LDAP store is used as the User Identity Store.</p> <p>Oracle recommends that you use only the Oracle Access Management Console or WebLogic Scripting Tool (WLST) commands for changes; do not edit oam-config.xml.</p> <p>By default, Access Manager uses the Embedded LDAP in the WebLogic Server domain as the user identity store. However, a number of other external LDAP repositories can also be registered as user identity stores. In this case, one store must be designated as the System Store that contains Administrator roles and users.</p>
Oracle Access Management configuration data file: oam-config.xml	<p>During the initial deployment process, described in the <i>Oracle Fusion Middleware Installation Guide for Oracle Identity and Access Management</i>, Oracle Access Management configuration data is stored in an XML file: oam-config.xml. See "oam-config.xml Configuration Data File".</p>

Table 5-1 (Cont.) Data Sources for Oracle Access Management

Data Source	Description
Keystores	<p>Several keystores are associated with Oracle Access Management services as described in "Introduction to Oracle Access Management Keystores".</p> <ul style="list-style-type: none"> • Embedded Java Keystore: Used for certificates for Simple or Certificate-based communication between OAM Servers and Webgates. The keystore bootstrap occurs upon initial AdminServer startup after running the Configuration Wizard. See: "Access Manager Security Keys and the Embedded Java Keystore" • Security Token Service Keystores: Access Manager and Security Token Service keystore should always be different. For more information, see "Access Manager Keystores". • Identity Federation Keystores: Keystore settings enable you to create aliases (a short hand notation) for keys in the keystore. See: "Identity Federation Keystore"

Table 5-2 contains the Oracle Access Management services and links to information about the data sources used for each.

Table 5-2 Data Sources for Oracle Access Management Services

Service	Description
Access Manager	<p>Access Manager supports multiple Identity Stores and provides SSO authentication using data sources:</p> <ul style="list-style-type: none"> • Registering and Managing User Identity Stores • Managing the Policy and Session Database • oam-config.xml Configuration Data File • Access Manager Security Keys and the Embedded Java Keystore
Identity Federation	<p>Identity Federation supports multiple Identity Stores which can be assigned on a per Identity Partner basis. Each Identity Store must be registered with Access Manager. If no Identity Store is defined in the Identity Partner, the designated Default Store is used.</p> <ul style="list-style-type: none"> • About Using Multiple Identity Stores • Identity Federation Keystore • Administering Identity Federation As A Service Provider
Security Token Service	<p>Security Token Service uses only the designated Default Store for user identities.</p> <ul style="list-style-type: none"> • Access Manager Keystores • "Configuration overview: Identity Propagation with the Username Token". • Managing Security Token Service Certificates and Keys
Mobile and Social	<p>Mobile and Social provides its own Identity Directory Service configuration that points to directory servers for user authentication and/or user profile services. There is no dependency on the global data sources upon which Access Manager and other Oracle Access Management services rely.</p> <ul style="list-style-type: none"> • Configuring Mobile and Social Services

See Also:

- ["Managing Global Password Policy"](#)
["Configuring 11g WebGate and Authentication Policy for DCC"](#)
 - ["About using the System Store for User Identities"](#)
 - [Maintaining Access Manager Sessions](#) for details about sessions stored in-memory using Oracle Coherence and propagated to Oracle Database
 - [Auditing Administrative and Run-time Events](#) for details about Audit data stored within audit files or a separate Oracle Database
-

The following sections contain additional details.

- [oam-config.xml Configuration Data File](#)
- [About the Default LDAP Group](#)

5.1.1 oam-config.xml Configuration Data File

Oracle Access Management provides an XML file (`oam-config.xml`) containing all Access Manager-related system configuration data. Any changes made to the Access Manager deployment configuration, including server and agent registration, are stored in `oam-config.xml` and are automatically propagated to each Access Manager server. Each Access Manager server has a local copy of the latest configuration XML file. Whether you have failover configured in a high-availability environment or not, all Access Manager servers always have the latest `oam-config.xml` file.

Oracle recommends not editing `oam-config.xml` directly. Manual changes to this file could result in lost data or overwriting of the file during data sync operations. However, if you must edit `oam-config.xml`, use the following guidelines:

- Back up `oam-config.xml` in: `$DOMAIN_HOME/config/fmwconfig/` and store the copy in a different location for use if needed.
- Make your changes on the node running the AdminServer to minimize possible conflicts that another AdminConsole user might make.
- If Access Manager Servers are running, increment the configuration version number at the top of the file to associate your change and enable automatic propagation and dynamic activation across all OAM Servers. For example, see the next to last line of this example (existing value + 1):

```
<Setting Name="Version" Type="xsd:integer">
  <Setting xmlns="http://www.w3.org/2001/XMLSchema"
    Name="NGAMConfiguration" Type="htf:map:>
    <Setting Name="ProductRelease" Type="xsd:string">11.1.1.3</Setting>
    <Setting Name="Version" Type="xsd:integer">2</Setting>
  </Setting>
```

5.1.2 About the Default LDAP Group

The default LDAP group, **Administrators**, is set during initial deployment using the Oracle Fusion Middleware Configuration Wizard.

For more information, see ["About Oracle Access Management Administrators"](#).

5.2 Registering and Managing User Identity Stores

A User Identity Store is a centralized LDAP repository in which an aggregation of Administrator and user-oriented data is stored and maintained in an organized way.

Oracle Access Management supports multiple LDAP vendors, and multiple LDAP stores can be registered for use by Oracle Access Management and its services. Oracle Access Management addresses each user population and LDAP directory store as an identity domain. Each identity domain maps to a configured LDAP User Identity Store that must be registered with Oracle Access Management. This section provides the information you need to register and manage user identity stores using the Oracle Access Management Console.

- [Understanding User Identity Stores](#)
- [About using the System Store for User Identities](#)
- [About Using Multiple Identity Stores](#)
- [User Identity Store Settings](#)
- [Registering a New User Identity Store](#)
- [Viewing or Editing a User Identity Store Registration](#)
- [Deleting a User Identity Store Registration](#)

Note:

Oracle recommends that you use the Profiles to access identity data stores rather than the legacy OAM ID Stores function as it will be deprecated in a future release. This is documented in [Managing the Identity Directory Service User Identity Stores](#).

5.2.1 Understanding User Identity Stores

During initial WebLogic Server domain configuration using the Oracle Fusion Middleware Configuration Wizard, the Embedded LDAP is configured as the one and only user identity store for Oracle Access Management. Within the Embedded LDAP, the Administrators group is created with `weblogic` seeded as the default Administrator.

Note:

The Embedded LDAP performs best with fewer than 10,000 users. With more users, consider a separate enterprise LDAP server. In a highly available configuration, Oracle recommends that an external LDAP is used as the User Identity Store. See *Oracle Fusion Middleware Securing Oracle WebLogic Server*.

When attempting to access an Access Manager-protected resource, a user can be authenticated against any store, not simply the designated Default Store. That said, there are a few considerations:

- **System Store:** Only one User Identity Store can (and must) be designated as the System Store. This is used to authenticate Administrators signing in to use the Oracle Access Management Console, remote registration tools, and custom administrative commands in WLST. Thus, Administrators using the Oracle Access Management Console or remote registration utility must have credentials stored in the System Store. Once you define a remote User Store as the System Store, you must change the `OAMAdminConsoleScheme` to use an LDAP Authentication Module that references the same remote user store (the System Store). For details, see [About using the System Store for User Identities](#)
- **Default Store:** As the name implies, the LDAP store designated as the Default Store is the automatic choice for use by LDAP authentication modules unless you configure use of a different store for the module or plug-in.

Note:

Users attempting to access an Access Manager-protected resource can be authenticated against any user identity store that is registered and defined in the authentication scheme while the Security Token Service uses only the Default User Identity Store. For example, when adding User Conditions to a Token Issuance Policy, the identity store from which the users are chosen must be the Default Store.

In the Oracle Access Management Console, User Identity Store registrations are organized under the Configuration Launch Pad. Administrators can register, view, modify, and delete User Identity Store registrations using either the Oracle Access Management Console or Customization Commands described in *WLST Command Reference for WebLogic Server*.

5.2.2 About using the System Store for User Identities

Users with valid Oracle Access Management System Administrator credentials can designate a registered user identity store as either the Default Store, the System Store or both.

You can select the Default and System Identity Store configurations using the Oracle Access Management Console as documented in [Managing the Identity Directory Service User Identity Stores](#)

UserIdentityStore1 is the embedded Access Manager LDAP store. After installation, the Oracle Access Management Console and OAM Policy Manager are protected by the IAM Suite Agent. The IAM Suite Application Domain is seeded with the OAM Admin Console Authentication Policy which uses the `OAMAdminConsoleScheme` authentication scheme. In turn, the `OAMAdminConsoleScheme` uses the LDAP Authentication module, and the System Store and the LDAP authentication module both use the WebLogic Embedded Identity Store (`UserIdentityStore1`). The Access Manager Administrator roles are mapped to the enterprise groups and users that belong to the System Store.

5.2.2.1 Using the System Store for User Identities

Changing the System Store impacts the entire identity management (IAM Suite) domain. When you want to change the System Store to a remote identity store, you need to create an Authentication Provider in WebLogic for this remote store.

The remote store provider should be displayed after the IAMSuiteAgent provider in the list of providers in the WebLogic console. Additionally:

- Ensure the control flags for all providers preceding the new remote store provider are set to SUFFICIENT or OPTIONAL.
- Assign ADMIN, the WebLogic global role, to the enterprise groups or users from this remote store. This can be done by following the steps to prepare the remote store using IDM Config Tool and by referring to the WebLogic documentation.
- If using Oracle Unified Directory as a system store, create IPlanetAuthenticator in WebLogic.

The above configuration should be done and tested before you change the System Store to a remote store. You will also have to change the LDAP authentication module configuration to use the remote store. The remote store can be configured using OAM Identity Store or IDS Profile.

Note:

Administrator login works only when the LDAP Authentication Module (used by the `OAMAdminConsoleScheme`) also uses the System Store. If you set another store as a remote store, ensure that the `OAMAdminConsoleScheme` is modified to avoid a lockout.

When you want to use a WebGate to protect the Oracle Access Management Console (on the AdminServer) and the Policy Manager Console (on the OAM Server), in addition to the above procedure, create an OAM Identity Asserter in WebLogic and enable OAM as the SSO provider in JPS using WLST commands. For details, see [Integrating Oracle ADF Applications with Access Manager SSO](#). You will also have to whitelist the OAM Policy Manager Console host name and port, and delete the IAMSuiteAgent provider from WebLogic to fully enable WebGate protection.

Information regarding administrator roles can be found in [Managing Administrator Roles](#)

5.2.3 About Using Multiple Identity Stores

Administrators can install and register multiple user identity stores for Oracle Access Management. Each identity store can rely on a different LDAP provider.

When more than one identity store is registered, an Administrator must define:

- The System Store: Administrators can login against the System Store only.
- The Default Store: Comes into play during patching and when using Identity Federation, and Security Token Service.
 - Patching: Oracle recommends that before patching, you designate `UserIdentityStore1` as the Default Store and also update LDAP Authentication Modules to use `UserIdentityStore1` (the Embedded LDAP of Weblogic Server).
 - Identity Federation: Supports multiple identity stores, on a per IdP Partner basis. The specified identity store must be registered like any other store. If no

identity store is defined in the IdP Partner, the Default Store is used. For details, see [Administering Identity Federation As A Service Provider](#).

- Security Token Service: An LDAP server is required for Security Token Service to map the Username token referencing the user to an LDAP User record, and thus use that record to populate the outgoing token. Ensure that the desired LDAP server is registered and configured as the Oracle Access Management Default Identity Store, as described in "[About using the System Store for User Identities](#)". For more information, see "[Configuration overview: Identity Propagation with the Username Token](#)".
- The specific store to use with each LDAP authentication module or plug-in (and Form or Basic authentication schemes)

External LDAP repositories can provide user, role, and group membership information. A user's group memberships, for example, are calculated at login time and stored for the duration of the session. Information is used as follows:

- When evaluating policies during authentication
- When evaluating identities for authorization conditions in a policy
- When using LDAP to search for identities for conditions in an authorization policy

Note:

There is no way to flush a user's group memberships information to force Oracle Access Management to recalculate it at a later date.

Registering user identity stores is required to provide connectivity with OAM Servers. After registering the identity store, Administrators can reference it in one or more authentication modules that form the basis for authentication schemes.

Oracle Access Management addresses each user population and directory as an identity domain. Each identity domain simply maps to a configured identity store name.

In the first Oracle Access Manager 11g release, users were identified using a simple user name/id field both internally and externally. Support for multiple identity realms requires cross-realm representation of a user or a group or any entity that resides within the identity store. This representation, referred to as a canonical identifier, serves as a unique identifier to various run time and administrative components of Oracle Access Management:

- **External Representation:** Qualifies the simple user name with identity domain information.

For instance, in Oracle Access Management Console a table that lists user names includes a column that displays the identity domain of the respective user. Identity domains map to identity store names. All functional components (the console, Policies, Responses, Logging, Session management, Auditing, and so on) that display user information will begin to qualify the same with the identity domain information.

- **Internal Representation:** To support disambiguation, OAM stores and uses the fully-qualified name (or uses both fields, as-is, to form a composite key).

For instance, The Session Management Engine does this to eliminate the need to store composite). In any case, the fully-qualified name is not visible.

5.2.3.1 Components of Oracle Access Management that use Identity Stores

The run time and administrative components of Oracle Access Management use identity stores.

[Table 5-3](#) documents the various run time and administrative components of Oracle Access Management.

Table 5-3 Components That Use Identity Stores

Component	Description
Authorization Policy Administration	Authorization policy administration allows authoring of grants to users or groups. Administrators can search within specific identity stores, selecting certain users or groups and granting or denying them access. Search results provide canonical identifiers for users and groups such that those values are stored as principals of the Identity Condition type of an Access Manager Authorization policy. The console displays the names and the Identity Store of origin.
Run Time	Authentication and Authorization relies on the Policy run time component. <code>OAMIdentity</code> is the runtime representation of the authenticated user and any groups that the user is a member of (if any). During policy evaluation, information present within the <code>OAMIdentity</code> is matched with what is stored as part of authorization policy's Identity Constraint. The domain is asserted as a Name Qualifier within the token. For OAM Proxy, in addition to the existing <code>OAM_REMOTE_USER</code> header, a second <code>OAM_IDENTITY_DOMAIN</code> header is set on every request for an authenticated user, such that a consuming application can disambiguate the user if needed.
Sessions	Session Management searches inform Administrators as to the user Identity Store, which is listed in the search results table.
Auditing and Logging	The user Identity Store against which the user has been authenticated is accounted for during auditing and logging.

See Also:

- ["User Identity Store Settings"](#)
 - ["Managing Administrator Roles"](#)
 - ["About using the System Store for User Identities"](#)
 - Access Manager WLST Commands in *Oracle Fusion Middleware WebLogic Scripting Tool Command Reference for Identity and Access Management*
-
-

5.2.4 User Identity Store Settings

You can create a user identity store from the **System Configuration** tab.

Figure 5-1 illustrates the Create User Identity Store Page, which provides fields where you enter details for your store and default settings that you can edit for your environment. The Store Type drop-down list provides supported choices.

Figure 5-1 Creating User Identity Store Registration

Required settings are identified by the asterisk (*) on the page. Table 5-4 describes each element and is organized by element types.

Table 5-4 User Identity Store Elements

Sectio n	Eleme nts	Description
Gener al	Store Name	A unique name for this registration. Use up to 30 characters for the name.

Table 5-4 (Cont.) User Identity Store Elements

Section	Elements	Description
Store Type		<p>A list of all supported LDAP providers from which you can choose. You can have multiple identity stores, as described in "About Using Multiple Identity Stores".</p>  <p>See Also: Table 24-6.</p>
Description		Optional.
Enable SSL		<p>Click to check this box and indicate that SSL is enabled between the directory server and OAM Server.</p> <p>Using the keytool command line interface, you must also import the appropriate CA root certificate and server certificate to the default JDK keystore (located at \$JAVA_HOME/lib/security/cacerts).</p> <p>NOTE: The CA root certificate can be added to any keystore as long as the appropriate values regarding that keystore are set for the following Java properties. To do this, start the OAM Admin Server and Managed Server instances with the appropriate values and the -D option.</p> <ul style="list-style-type: none"> • javax.net.ssl.trustStore=trust.jks • javax.net.ssl.trustStorePassword=<trustPass> • javax.net.ssl.keyStore=keystore.p12 • javax.net.ssl.keyStoreType=pkcs12 • javax.net.ssl.keyStorePassword=<keyStorePass>
Prefetched Attributes		<p>List of comma-separated user attributes; for example, email, phone, mobile. The OAM server will cache the list of user attributes in memory while it authenticates the user against the identity store. The cached values will be used to compute the Authentication response headers, Authorization policy response headers and Authorization policy conditions. Pre-fetched attributes provide huge performance improvements by avoiding a round trip to the user identity store. The OAM Administrator has to make sure all the user attributes used in Authentication and Authorization policy response headers and Authorization conditions are defined as prefetched attributes in the user identity store profile.</p>
User Native ID Store		<p>This enables getting the authentication code for natively locked/disabled/pw_must_change code in the LDAP authentication module.</p>

Table 5-4 (Cont.) User Identity Store Elements

Section	Elements	Description
Location and Credentials	Location	<p>The URL for the LDAP host, including the port number. Oracle Access Management 11g support multiple LDAP URLs with failover capability. The Identity Assertion Provider fails over to the next LDAP URL based on the order in which these appear.</p> <p>Enter one (or more) LDAP URLs in <i>host:port</i> format, Multiple URLs must be separated by a space or new line. There is no need to specify <code>ldap://</code> or <code>ldaps://</code> (which supports <code>SSL_NO_AUTH</code>) in the URL value:</p> <pre>localhost:myhost:7001</pre> <p>Note: The number of characters a supported URL can have is based on the browser version. Ensure that your applications do not use URLs that exceed the length that Oracle Access Management and the browser can handle.</p>
	Bind DN	<p>The user DN for the connection pool over which all other BINDs occur. Oracle recommends a non administrative user with appropriate Read and Search privileges for the user and group base DNs.</p> <p>For example:</p> <pre>uid=amldapuser,ou=people,o=org</pre>
	Password	<p>The password of the Principal, which is encrypted for security.</p>
Users and Groups	Login ID Attribute	<p>The attribute that identifies the login ID (user name).</p> <p>For example:</p> <pre>uid</pre>
	User password attribute	<p>The attribute in the user identity store (LDAP directory) which stores the user's password. This is made configurable for added flexibility.</p>
	User Search Base	<p>The node in the directory information tree (DIT) under which user data is stored, and the highest possible base for all user data searches.</p> <p>For example:</p> <pre>ou=people,ou=myrealm,dc=base_domain</pre>
	User Filter Object Classes	<p>The object classes to be included in search results for users, in a comma-separated list of user object class names. For example: <code>user, person</code>.</p>
Group Name Attribute	<p>The attribute that identifies the group name.</p> <p>Default: <code>cn</code></p>	

Table 5-4 (Cont.) User Identity Store Elements

Section	Elements	Description
	Group Search Base	Currently only static groups are supported, with the <code>uniquemember</code> attribute. The node in the directory information tree (DIT) under which group data is stored, and the highest possible base for all group data searches. For example: <code>ou=groups,ou=myrealm,dc=base_domain</code>
	Group Filter Classes	The object classes to be included in the search results for groups, in a comma-separated list of group object classes. For example: <code>groups,groupOfNames.</code>
	Enable Group Membership Cache	Boolean value for group cache: true or false. Default: true
	Group Cache Size	Integer for the group cache size. Default: 10000
	Group Cache Time-to-Live (seconds)	Integer (in seconds) for Time to Live for group cache elements. Default: 0
Connection Details	Minimum Pool Size	The smallest size set for the connection pool. Default: 10
	Maximum Pool Size	The greatest size set for the connection pool. Default: 50
	Wait Timeout	The number (in seconds) that connection requests can wait before timing out in the event of a fully utilized pool. Default: 120
	Inactivity Timeout	The number (in seconds) that connection requests can be inactive before timing out in the event of a fully utilized pool.
	Referral Policy	One of these values: <ul style="list-style-type: none"> • follow: Follows referrals during an LDAP search (Default) • ignore: Ignores referral entries during an LDAP search • throw: Results in a Referral Exception, which can be caught by the component user.

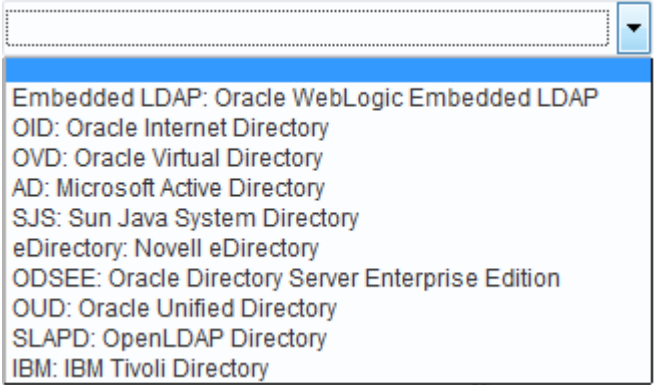
Table 5-4 (Cont.) User Identity Store Elements

Section	Elements	Description
	Enable Password Management	Enables password policy enforcement against the attribute values listed below. The corresponding options in the password policy must be configured as well.
	Use Oblix User Schema	Enables the use of OBLIX schema instead of standard Oracle schema.
	Global Common ID Attribute	Specifies the User ID attribute name. This attribute will be used as part of the password policy to check that the user ID is not part of the password.
	First Name Attribute	Specifies the First Name attribute name. This attribute will be used as part of the password policy to check that the user's first name is not part of the password.
	Last Name Attribute	Specifies the Last Name attribute name. This attribute will be used as part of the password policy to check that the user's last name is not part of the password.
	Results Time Limit (seconds)	<p>Results Time Limit is not supported. Alternatively, use <code>OperationTimeout</code> as described:</p> <p><code>OperationTimeout</code> specifies the time (in milliseconds) IDS waits for an LDAP request to be acknowledged by the LDAP remote host.</p> <p>Default value is 120000 milliseconds</p> <p>For IDS based profiles, use the <code>modifyLDAPAdapter WLST</code> command to set the timeout value. For example:</p> <pre>modifyLDAPAdapter(adapterName='ADAPTER_NAME', attribute='OperationTimeout', value=120000, contextName='ids')</pre> <p>For original idstore profiles, edit the <code>oam-config.xml</code> and set the value inside the idstore snippet. For example,</p> <pre><Setting Name="CONN_TIMEOUT" Type="xsd:string">120000</Setting></pre> <p>Increment <code>oam-config.xml</code> version by one after the edit.</p>
	Retry Count	Not currently supported.
	Email Address Attribute	Not currently supported.

Table 5-4 (Cont.) User Identity Store Elements

Section	Elements	Description
	Challenge Questions Attribute	Not currently supported.
	Challenge Answers Attribute	Not currently supported.

Figure 5-2 shows the Default and System Store designations. Notice the Access System Administrators section. You can add or remove Administrator roles only within the defined System Store and the store itself.

Figure 5-2 System Store Registration

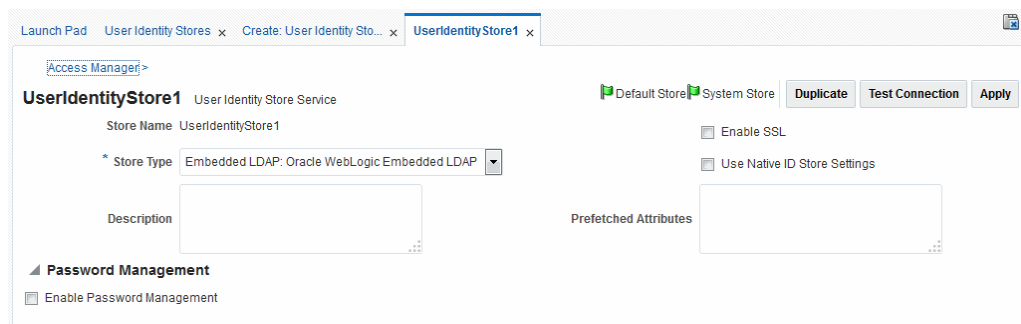

See Also:

Details about classifying users in [Managing Policies to Protect Resources and Enable SSO](#)

5.2.5 Registering a New User Identity Store

Users with valid Oracle Access Management Administrator credentials can register a new user identity store using the Oracle Access Management Console.

After you register the identity store, you can reference it in one or more authentication modules that form the basis for authentication schemes. You can also reference a specific identity store within Identity Conditions in Authorization Policies. Before you begin:

- Install the user identity store that you intend to register with Oracle Access Management.
- Extend the LDAP directory schema for Access Manager, as described in *Oracle Fusion Middleware Installation Guide for Oracle Identity and Access Management*.

- Create Users and Groups in the LDAP directory, as described in your vendor documentation.

Follow this procedure to register a new identity store definition:

1. At the top of the Oracle Access Management Console, click **Configuration**.
2. In the Configuration console, click **User Identity Stores**.
3. In the OAM ID Stores section, click **Create**.
4. Fill in the form with appropriate values for your deployment ([Table 5-4](#)), then click **Apply** to submit the registration.
5. **Test Connection:** Click **Test Connection** to confirm connectivity, then close the Confirmation window.
6. Close the registration page.
7. **Add Administrators:** See "[Managing Administrator Roles](#)".
 - a. In the navigation tree, double-click the store name to open the registration page.
 - b. In the Access System Administrators section, click the + above the table.
 - c. Fill in the Add System Administrator Roles dialog box (...).
 - d. Click **Apply**.
8. **Set Default Store:** See "[About using the System Store for User Identities](#)".
9. Click **Apply** to submit the registration and close the page.
10. Configure one or more authentication modules or plug-ins to use this store, as described in:
 - "[Native LDAP Authentication Modules](#)"
 - "[Orchestrating Multi-Step Authentication with Plug-in Based Modules](#)"

5.2.6 Viewing or Editing a User Identity Store Registration

Users with valid Oracle Access Management Administrator credentials can view or modify the registration of a user identity store. The user identity store that you intend to register must be installed and running.

To view or modify a user identity store registration:

1. At the top of the Oracle Access Management Console, click **Configuration**.
2. In the Configuration console, click **User Identity Stores**.
3. In the OAM ID Stores list, select the target identity store and click **Edit**.
4. Modify values as needed (see [Table 5-4](#)).
5. Click **Apply** to update the registration (or close the tab without applying changes).
6. **Test Connection:** Click **Test Connection** button to confirm connectivity, then close the Confirmation window.

7. **Set as System or Default Store:** See "[About using the System Store for User Identities](#)".
8. **Manage Administrator Roles:** See "[Managing Administrator Roles](#)".
9. Configure one or more authentication modules or plug-ins to use this store, as described in:
 - "[Native LDAP Authentication Modules](#)"
 - "[Orchestrating Multi-Step Authentication with Plug-in Based Modules](#)"
10. Close the page when you finish.

5.2.7 Deleting a User Identity Store Registration

Users with valid Oracle Access Management Administrator credentials can use this procedure to delete a user identity store registration using the Oracle Access Management Console. You cannot delete the Default Store or System Store registration.

To delete a user identity store registration:

1. Edit LDAP Authentication Modules that reference the store to be deleted (to ensure a valid identity store is referenced within the module).
2. At the top of the Oracle Access Management Console, click **Configuration**.
3. In the Configuration console, click **User Identity Stores**.
4. In the OAM ID Stores list, select the target identity store and click **Delete**.
5. In the confirmation dialog that appears, click **Delete** to confirm the deletion (or click Cancel to dismiss the window and retain the instance).
6. Confirm that the definition is no longer listed in the navigation tree.

5.3 Managing the Identity Directory Service User Identity Stores

(IDS) is a flexible and configurable service used by Access Manager as the means for accessing multiple identity data stores. The purpose of IDS is to allow the management of users or groups from identity stores not deployed with Access Manager itself.

The following sections contain the details.

- [Identity Directory Services](#)
- [Creating an Identity Directory Service Profile](#)
- [Editing or Deleting an Identity Directory Service Profile](#)
- [Creating a Form-fill Application Identity Directory Service Profile](#)
- [Understanding the Pre-Configured Identity Directory Service Profile](#)
- [Creating an Identity Directory Service Repository](#)

5.3.1 Identity Directory Services

offers a consistent and rationalized technology to access identity stores that eliminates redundant configurations and simplifies Identity Management operations.

IDS provides the following benefits:

1. Support for different types of user directories including integration with native user/password state managed by the directory.
2. Consistent administration user interface and a paradigm for working with different identity stores across Oracle Identity Management components.
3. Built in failover and load balancing capabilities.
4. Logical to physical attribute mapping and entity relationships.

The following list of directory servers are among those supported.

- Microsoft Active Directory
- Novell eDirectory
- Oracle Directory Server Enterprise Edition
- Oracle Internet Directory
- Oracle Unified Directory
- Oracle Virtual Directory
- OpenLDAP
- IBM Tivoli Directory Server
- WebLogic Server Embedded LDAP

Note:

Oracle recommends that you use the Profiles to access identity data stores rather than the legacy OAM ID Stores function as it will be deprecated in a future release.

[Figure 5-3](#) is a screen capture of the console page.

Figure 5-3 Identity Directory Service Console Page

Configuration >

User Identity Stores

Default and System Store Apply

Default Store: UserIdentityStore1

System Store: msmad

OAM ID Stores Sync IDS Profiles

Manage local User Identity Stores. This includes IDS Profiles that are synchronized by using Sync IDS Profiles button.

View

Name	Directory Type	Host Information	Description	Synced IDS Profiles
UserIdentityStore1	EMBEDDED_LDAP	ldap-host:7001		No
IDSPROFILE-idxuserrole				Yes
msmad	AD	domain2.bitzerqa1.com		No
IDSPROFILE-ESSOIDS				Yes
IDSPROFILE-idsprofile				Yes
IDSPROFILE-userrole				Yes

Identity Directory Service

Identity Directory Service is a common service used by Oracle Identity Management products to access and manage Identity Directory. The IDS Profiles can be used within Oracle Access Management after they are synchronized.

IDS Profiles Create Form-Fill Application IDS Profile

Manage common Identity Directory Service Profiles. IDS Profiles created here will appear in OAM ID Stores table. You have to synchronize IDS Profiles created outside Oracle Access Management Console using Sync IDS Profile button

View

Name	Description	Repository Name	Created By
userrole	User/Role entities in Default Identity Directory		OPSS
idxuserrole	Fusion User/Role entities in Default Identity Direc...		OPSS
idsprofile	Identity profile for omss	idsprofile	OAM
ESSOIDS		ESSOIDSREP	OAM-Form-Fill

IDS Repositories

Manage Identity Directory Service Repositories that are common across Oracle Identity Management

View

Name	Directory Type	Host Information
ESSOIDSREP	OU	slc07fyk.us.oracle.com:1389
idsprofile	ACTIVE_DIRECTORY	domain2.bitzerqa1.com:389

Note:

Note this page contains the configuration panel for the legacy OAM ID Stores. Oracle recommends that you use the Profiles to access identity data stores rather than the legacy OAM ID Stores function as it will be deprecated in a future release.

Configuring an Identity Directory Service store involves configuring parameters for an IDS Profile and an IDS Repository. The IDS Profile specifies the full scope of traits for a particular type of identity store. It is the logical configuration for the repository and contains the following data.

- Entity definition
- Entity relationship definition

- Default operational configuration (including the tenant search/create base, the tenant filter, timeouts and cache configuration)

The IDS Repository configuration defines the actual location of the store. The IDS Repository is a physical configuration that containing the following data.

- Connection details (including the host machine, port number and credentials)Connection pool detailsHigh-availability/failover configurationEntity attribute mapping

5.3.2 Creating an Identity Directory Service Profile

You can create an profile form the **Configuration** console.

To create:

1. At the top of the Oracle Access Management Console, click **Configuration**.
2. In the Configuration console, click **User Identity Stores**.
3. In the IDS Profiles section, click **Create**.

The Create IDS Profile page is displayed as in [Figure 5-4](#).

Figure 5-4 Create IDS Profile Page

Create Identity Store Profile ✕

* Name

Description

▲ **Repository** Repository Options Create New Use Existing Test Connection

* Name

* Directory Type

* Hosts View ▼ + Add ✕ Remove

Host Name	Port	Load Distribution (%)
<input type="text"/>	3060 ▲ ▼	100 ▲ ▼

Availability Failover Load balanced

SSL Enabled

* Bind DN

* Bind Password

* Base DN

Password Management Enabled

Use Native ID Store Settings

Use Oblix User Schema

▲ **User**

Base DN Login ID Attribute

RDN Attribute Global Common ID Attribute

Object Classes View ▼ + Add ✕ Remove

Object Class Name
<input type="text" value="inetorgperson"/>

▲ **Group**

Base DN ID Attribute

RDN Attribute

Object Classes View ▼ + Add ✕ Remove

Object Class Name
<input type="text" value="groupofuniquenames"/>

4. Provide the following values for the new profile.

- **Name** - Type a unique name for this User Profile Service Provider.
- **Description** - (Optional) Type a short description that will help you or another Administrator identify this service in the future.

5. Configure the Repository properties by selecting Create New or Use Existing.

Create New defines a new Repository object (that is, a reference to an LDAP directory server) for the Identity Directory Service connection. Click **Test Connection** after you have defined the values in the Repository section to verify they are correct. This option is only available when defining a new Identity Directory Service connection. **Use Existing** allows you to choose a previously defined Repository object by selecting it from the drop down menu.

- **(Repository) Name** - Enter a new unique name to create, or choose an existing one from the menu. After entering a new name, configure properties for the Identity Directory Service connection.
- **Directory Type** - Select the type of directory server software hosting the Repository; for example, *Microsoft Active Directory* or *Oracle Internet Directory*. If your directory is not listed, leave this field empty. If you are not defining a new Identity Directory Service connection or creating a new repository, this field is read-only.
- **Host Information** - Contains information about the host computer on which the Identity Directory Service Repository is located. Add multiple hosts if the directory server is part of a cluster. Click **Add** to add a new host to the table. In the **Host Name** column type either the IP Address or the name of the computer (or virtual computer) on which the Directory server is running. In the **Port** column, type the port number that the directory server is configured to use. If the hosts are part of a cluster, in the **Load Distribution** column type the load amount as a percentage that should be directed to each host. For multiple hosts, the amount should add up to 100%. To delete a host, select its row in the table and click **Remove**. If you are not defining a new Identity Directory Service connection or creating a new repository, this field is read-only.
- **Availability** - Choose **Failover** if the cluster is configured for failover operation, or choose **Load balanced** if the cluster distributes the load across multiple hosts. This field is read-only if you are using an existing repository.
- **SSL** - Select **Enabled** if the connection is configured for SSL. (See the *Securing Applications with Oracle Platform Security Services* for SSL configuration details.)

Note:

Follow this procedure to add the SSL certificates required for setting the TLS connection.

- a. Create the LibOVD keystore by running this command.

```
MW_HOME/oracle_common/bin/libovdconfig.sh -host WLS_ADMIN_HOST
-port WLS_ADMIN_PORT -userName weblogic
-domainPath WLS_DOMAIN_PATH -createKeystore
-contextName ids
```

Enter the AdminServer password and the password used for the LibOVD keystore when requested.

- b. Import the OID server certificate into the LibOVD keystore.

```
keytool -importcert
-keystore DOMAIN_HOME/config/fmwconfig/ovd/
ids/keystores/adapters.jks
-storepass KEYSTORE_PASSWORD -alias ALIAS_NAME
-file FULL_PATH_TO_CERTFILE -noprompt
```

- **Bind DN** - Type the distinguished name (DN) of the LDAP Administrator used to authenticate to the Directory server.
 - **Bind Password** - Type the Bind DN password used to authenticate to the Directory server.
 - **Base DN** - Type the base distinguished name (DN) where User and Group data is located.
 - **Password Management** - selecting **Enable Password Management** enables password policy enforcement against the attribute values listed in [Table 5-4](#). The corresponding options in the password policy must be configured as well.
6. Configure the User properties to configure the LDAP User object in Mobile and Social User Profile services.

Note:

These fields are read-only if using an existing Identity Directory Service connection.

- **Object Classes** - Click **Add** to add a custom object class that represents people in an organization as defined on your directory server.
- **RDN Attribute** - Type the relative distinguished name attribute (for example, *cn*) designated for the User object on the directory server.
- **Base DN** - Type the base DN (in LDAP form) for the User object on the directory server.
- **Login ID Attribute** - Type the LDAP attribute from which the login ID specifying the User will be extracted.

- **Global Common ID Attribute** - Type the global common user ID attribute.
7. Configure the Group properties to configure the LDAP group object in Mobile and Social User Profile services.
- **Object Classes** - Click **Add** to add a custom object class that represents a group of people in an organization as defined on your Directory server.
 - **RDN Attribute** - Type the relative distinguished name attribute (for example, *cn*) designated for the Group object on the directory server.
 - **Base DN** - Type the base DN (in LDAP form) for the Group object on the directory server.
 - **ID Attribute** - Type the LDAP attribute from which the ID designated for the Group object will be extracted.
8. Click **Create**.
- The profile is displayed in the IDS Profiles table.

5.3.3 Editing or Deleting an Identity Directory Service Profile

To edit or delete an IDS Profile, select the name in the table and click **Edit** or **Delete** in the tool bar.

Editing the profile allows for additional configuration properties for the Identity Directory Service connection.

- **Name** - Choose an Identity Directory Service connection to associate with the User Profile Service Provider from the drop down menu.
 - If you choose either of the default Identity Directory Services (either *userrole* or *idxuserrole*) you cannot view or edit the configuration values.
 - If you choose an Identity Directory Service connection that you or another Administrator created, you can view and edit the configuration values as needed.
- **General and Repository** - Use the fields under this tab to edit the Directory Service and Repository configuration values that Mobile and Social uses to connect to the Directory Service.
 - **Repository Name** - Choose from the menu a repository to associate with the Identity Directory Service connection. After choosing a repository, configure its properties using the following form fields.
 - **Directory Type** - Displays the type of Directory server software hosting the Repository, for example *Microsoft Active Directory*, *Oracle Internet Directory*, and so on. This field is read-only.
 - **Host Information** - Displays information about the host computer where the Identity Directory Service Repository is located. Add multiple hosts if the Directory server is part of a cluster. Click **Add** to add a new host to the table. In the **Host Name** column type either the IP Address or the name of the computer (or virtual computer) that the Directory server is running on. In the **Port** column, type the port number that the Directory server is configured to use. If the hosts are part of a cluster, in the **Load Distribution** column type

the load amount as a percentage that should be directed to each host. For multiple hosts, the amount should add up to 100%. To delete a host, select its row in the table and click **Remove**. If you are not defining a new Identity Directory Service connection or creating a new repository, this field is read-only.

- **Availability** - Choose **Failover** if the cluster is configured for failover operation, or choose **Load balanced** if the cluster distributes the load across multiple hosts. This field is read-only if you are using an existing repository.
- **SSL** - Select **Enabled** if the connection is configured for SSL. Otherwise clear the option box. See **SSL** in [Creating an Identity Directory Service Profile](#) for information on how to add the SSL certificates required for the TLS connection.
- **Bind DN** - Type the distinguished name (DN) of the LDAP Administrator used to authenticate to the Directory server.
- **Bind Password** - Type the Bind DN password used to authenticate to the Directory server.
- **Base DN** - Type the base distinguished name (DN) where User and Group data is located.
- **Password Management** - selecting **Enable Password Management** enables password policy enforcement against the attribute values listed in [Table 5-4](#). The corresponding options in the password policy must be configured as well.
- **Entity Attributes** - Use the fields under this tab to view or edit the attributes that Mobile and Social uses to navigate the corporate directory service schema. Click **Add** to add an attribute to the table or click **Remove** to delete an attribute.
 - **Name** - The attribute name.
 - **Physical Attribute** - The name of the corresponding physical attribute type in the underlying Repository.
 - **Type** - The attribute's data type.
 - **Description** - A brief description of the attribute.
 - **Sensitive** - Select to mark that the attribute contains sensitive information such as a password.
 - **Read-only** - Select to protect the attribute from modification.
- **Entities / User Properties** - Use the fields under the User sub head to configure how Mobile and Social interacts with the User entities on the LDAP server.
 - **Create Base** - Specifies the base DN (the top level of the LDAP directory tree) at which Users are defined.
 - **Search Base** - Specifies the search base DN for Users. Only entries at or below the search base DN are considered when processing the search operation.
 - **Create Object Classes** - Specifies the object class under which attributes associated with a person are stored.

- **RDN Attribute** - Specifies the relative distinguished name attribute, for example *cn*.
- **ID Attribute** - Specifies the attribute that uniquely identifies the User, such as the *uid* attribute or the *loginid* attribute.
- **Filter Object Classes** - Specifies the object class by which to filter.
- **Attributes Configuration** - Specify the User attributes that should be available to, and searchable by, the User Profile Service Provider.
 - * **Used** - Specifies if the attribute is used for Users in the directory service.
 - * **Attribute Name** - Specifies the name of the attribute as defined on the **Entity Attributes** tab.
 - * **In Results** - Select if the specified attribute should be returned in search results.
 - * **Searchable** - Select if the specified attribute should be available for search operations.
 - * **Search Operator** - Select a search operator from the menu to restrict how the specified attribute is searched.
- **Operations Configuration** - Select from **Create**, **Update**, **Delete**, and **Search** to enable those operations at the User entity level. Clear the option boxes to disable them.
- **Entities / Group Properties** - Use the fields under the Group sub head to configure how Mobile and Social interacts with the Group entities on the LDAP server.
 - **Create Base** - Specifies the base DN (the top level of the LDAP directory tree) at which Users are defined.
 - **Search Base** - Specifies the search base DN for Groups. Only entries at or below the search base DN are considered when processing the search operation.
 - **Create Object Classes** - Specifies the object class under which attributes associated with a Group are stored.
 - **RDN Attribute** - Specifies the relative distinguished name attribute; for example, *cn*.
 - **ID Attribute** - Specifies the LDAP attribute that uniquely identifies the Group.
 - **Filter Object Classes** - Specifies the object class by which to filter.
 - **Attributes Configuration** - Specify the Group attributes that should be available to, and searchable by, the User Profile Service Provider.
 - * **Used** - Specifies if the attribute is used for Users in the directory service.
 - * **Attribute Name** - Specifies the name of the attribute as defined on the **Entity Attributes** tab.

- * **In Results** - Select if the specified attribute should be returned in search results.
- * **Searchable** - Select if the specified attribute should be available for search operations.
- * **Search Operator** - Select a search operator from the menu to restrict how the specified attribute is searched.
- **Operations Configuration** - Select from **Create**, **Update**, **Delete**, and **Search** to enable those operations at the Group entity level. Clear the option boxes to disable them.
- **Relationships** - Use the fields under this tab to configure the relationship between attributes for this Identity Directory Service.
 - **Name** - The relationship name.
 - **(From) Entity** - Choose **User** to select from User attributes or choose **Group** to select from Group attributes in the **(From) Attribute** column.
 - **(From) Attribute** - Choose the attribute from which you are mapping.
 - **Relation** - Choose the menu option that describes the relationship between the specified attribute in the **From** column and the specified attribute in the **To** column.
 - **(To) Entity** - Choose **User** to select from User attributes or choose **Group** to select from Group attributes in the **(To) Attribute** column.
 - **(To) Attribute** - Choose the attribute to which you are mapping.
 - **Recursive** - Select if the relationship extends down the directory tree to include nested child entities or up the directory tree to include parent entities.
- **Relationship Configuration** - Type the URI segment used to access the corresponding column in the Identity Directory Service. Use **Add** to add a new relationship or **Remove** to remove a configured relationship.
 - **Access URI** - Type a URI segment that will be used to access a corresponding data column in the Identity Directory service. For example, if `memberOf` is the Access URI, then:

```
http://host:port/.../idX/memberOf
```

would be the URI to access related entities of an entity with ID `idX`.
 - **Identity Directory Service Relation** - Choose the Directory Service relationship that is to be accessed by the **Access URI** segment. You can configure relationships on the **Relationships** tab in the **Identity Directory Service** configuration section provided that the Identity Directory Service *is not* the pre-configured **UserProfile Identity Provider**. (You cannot configure Identity Directory Service relationships for the *UserProfile Service Provider*.)
 - **Entity URI Attribute** - Type the JSON attribute name to be used in the URI response sent from the Mobile and Social server. For example, if `person-uri` is the specified entity URI attribute, the URI response would be as follows:

```
{ {"person-uri":uriY1, ...}, {"person-uri":uriY2, ...}, ... }
```

where `uriY1` and `uriY2` are the direct URIs to access each of the related entities.

- **Scope for Requesting Recursion** - Use Scope attribute values with the scope query parameter to retrieve a nested level of attributes in a relationship search. To access related entities recursively, type the value to be used. The Mobile and Social default configuration uses two scope attribute values: `toTop` and `all`. If the **Scope for Requesting Recursion** value is the attribute value `all`, then the following REST URI example is used to make the request:

```
http://host:port/.../idX/reports?scope=all
```

In this example, the URI returns the entities related to the entity with ID `idX`, as well as all further related entities.

5.3.4 Creating a Form-fill Application Identity Directory Service Profile

To create an Identity Directory Service Profile for a Form-fill Application, click the Create Form-fill Application IDS Profile button on the left of the User Identity Stores console page.

(See [Figure 5-3](#).)

[Creating an Identity Directory Service Profile](#) and [Editing or Deleting an Identity Directory Service Profile](#) contain definitions for most of the Form-fill attributes. Additional definitions for the Entity Search Bases section specific to this type of profile are listed below.

- User Search Base - Full DN for the node at which enterprise users are stored in the directory; for example, `cn=Users,realm_DN`.
- App Template Search Base - Full DN for the node from which searches for the Application Templates will begin.
- Top Search Base - Full DN for the node from which searches will begin; for example, `cn=realm_DN`.

5.3.5 Understanding the Pre-Configured Identity Directory Service Profile

Mobile and Social provides a pre-configured IDS Profile named `UserIdentityStore1`. The Pre-Configured Identity Directory Service Profile allows lookup and update tasks to be performed on directory objects using Mobile and Social.

5.3.6 Creating an Identity Directory Service Repository

You can create an Identity Directory Service repository from the Configuration console.

To create an repository:

1. At the top of the Oracle Access Management console, click **Configuration**.
2. In the Configuration console, click **User Identity Stores**.
3. Click **Create** under IDS Repository.

The Create IDS Repository page is displayed as in [Figure 5-5](#).

Figure 5-5 Create IDS Repository Page

Create LDAP Repository [X]

[Test Connection]

* Name

* Directory Type [select one] ▼

* Hosts View ▼ + Add ✕ Remove

Host Name	Port	Load Distribution
<input type="text"/>	3060 ▲ ▼	100 ▲ ▼

Availability Failover Load balanced

SSL Enabled

* Bind DN

* Bind Password

* Base DN

Password Management Enabled

Use Native ID Store Settings

Use Oblix User Schema

[Create] [Cancel]

4. Provide the following values for the new repository.
 - a. Name: the entry must be a unique.
 - b. Select the Directory Type from the drop down choices.
5. Click Add to configure the physical location of the repository (Host name, Port number and Load Weightage percentage).
6. Configure the Repository properties as follows:
 - a. **(Repository) Name** - Enter a new unique name to create, or choose an existing one from the menu. After entering a new name, configure properties for the Identity Directory Service connection.
 - b. **Directory Type** - Select the type of directory server software hosting the Repository; for example, *Microsoft Active Directory* or *Oracle Internet Directory*. If your directory is not listed, leave this field empty. If you are not defining a new Identity Directory Service connection or creating a new repository, this field is read-only.

- c. **Host Information** - Contains information about the host computer on which the Identity Directory Service Repository is located. Add multiple hosts if the directory server is part of a cluster. Click **Add** to add a new host to the table. In the **Host Name** column type either the IP Address or the name of the computer (or virtual computer) on which the Directory server is running. In the **Port** column, type the port number that the directory server is configured to use. If the hosts are part of a cluster, in the **Load Distribution** column type the load amount as a percentage that should be directed to each host. For multiple hosts, the amount should add up to 100%. To delete a host, select its row in the table and click **Remove**. If you are not defining a new Identity Directory Service connection or creating a new repository, this field is read-only.
 - d. **Availability** - Choose **Failover** if the cluster is configured for failover operation, or choose **Load balanced** if the cluster distributes the load across multiple hosts. This field is read-only if you are using an existing repository.
 - e. **SSL** - Select **Enabled** if the connection is configured for SSL. See **SSL** in [Creating an Identity Directory Service Profile](#) for information on how to add the SSL certificates required for the TLS connection. (See the *Securing Applications with Oracle Platform Security Services* for SSL configuration details.)
 - f. **Bind DN** - Type the distinguished name (DN) of the LDAP Administrator used to authenticate to the Directory server.
 - g. **Bind Password** - Type the Bind DN password used to authenticate to the Directory server.
 - h. **Base DN** - Type the base distinguished name (DN) where User and Group data is located.
 - i. **Password Management** - selecting **Enable Password Management** enables password policy enforcement against the attribute values listed in [Table 5-4](#). The corresponding options in the password policy must be configured as well.
7. Click **Test Connection** to confirm the values are correct.
 8. Click **Create**.

The repository is displayed in the IDS Repositories table.

5.4 Managing Administrator Roles

By default, the Oracle Access Management Administrators role is the same as the WebLogic Administrators role (Administrators).

You can register another User Identity Store (Oracle Internet Directory, for example); however, user `weblogic` must be defined with at least one user in the registered store to authenticate against. Administrator login works only when the Authentication Scheme (and assigned Authentication Module) used by the IAMSuiteAgent, also uses the System Store. This section provides the following topics:

- [Understanding Administrator Roles](#)
- [Defining and Removing Administrator Roles](#)

5.4.1 Understanding Administrator Roles

Your enterprise might require independent sets of Administrators: one set of users responsible for Access Manager and another for Security Token Service. All

Administrator roles, users, and groups must be stored in the System Store. If the System Store changes, appropriate Administrator roles must be added to the new System Store.

If, when editing an Identity Store registration, you designate a store as the System Store the Access System Administrator section appears. You can add new Administrator roles when adding or editing a User Identity Store registration.

Figure 5-6 shows the page and controls to use.

Figure 5-6 Add System Administrator Roles

Add System Administrator Roles [X]

Search and select the users and/ or groups to add as System Administrators.

Search

Name

Type

[Search] [Reset]

View ▾ [Detach]

Name	Type
No data to display.	

[Add selected] [Cancel]

5.4.2 Defining and Removing Administrator Roles

Oracle Access Management Administrator roles which must be stored in the User Identity Store designated as the System Store can be defined or removed.

First, define the desired LDAP group to use for Administrators and then ensure that your Administrators group is available in the group search base. (See [About using the System Store for User Identities](#).) To add or remove an Administrator role from the System Store, follow this procedure.

1. **View System Store Registration:** Perform the following steps (or find a different System Store in the Data Sources node to designate as the System Store).
 - a. At the top of the Oracle Access Management Console, click **Configuration**.
 - b. In the Configuration console, click **Administration**.
The registered System Store can not be changed from this page.
 - c. Search the System Store to find configured administrators.

2. Add User Roles:

- a. Click the Grant (+) button above the Access System Administrators table to display the Add Users and Groups dialog box.
- b. Select **User** in the Type list and click **Search**.
- c. In the results list, click the desired user, then click **Add Selected**.
- d. Repeat as need to add desired Administrator User roles.
- e. Click **Apply** to submit user roles.

3. Add Group Roles:

- a. Click the **Grant** (+) button above the Access System Administrators table to display the Add Users and Groups dialog box.
- b. Select **Group** in the Type list and click the **Search** button.
- c. In the results list, click the desired Group and then click the **Add Selected** button.
- d. Repeat as need to add desired Administrator Group roles.
- e. Click **Apply** to submit Group roles.

4. Remove Administrator Roles:

- a. In the Access System Administrators table, click the row containing the user or group to remove.
- b. Click the **Delete** (x) button above the table.
- c. Confirm removal when asked.
- d. Click **Apply** to submit the removal.

5. Correct any authentication plug-ins that use the System Store (if this is a new store).

This procedure is described in "[Orchestrating Multi-Step Authentication with Plug-in Based Modules](#) "

6. Test the New Role: Close the browser window, then re-open it.

- a. Sign out of the Oracle Access Management Console and close the browser window.
- b. Start up the Oracle Access Management Console and attempt to log in using the previous Administrator role to confirm that this attempt fails.
- c. Log in using the new Administrator role to confirm that this attempt is successful.

Login Failure: See "[Administrator Lockout](#)".

5.5 Managing the Policy and Session Database

Oracle Access Management requires a database to store Access Manager policy data, password management data, and Access Manager sessions in a production

environment. At most, your deployment can have one policy store database (which serves password management) and one session store. By default, a single JDBC data source is used for both.

This section includes the following topics:

- [About the Database Store for Policy, Password Management, and Sessions](#)
- [About Database Deployment](#)
- [Configuring a Separate Database for Access Manager Sessions](#)

5.5.1 About the Database Store for Policy, Password Management, and Sessions

In a production environment, the Oracle database stores policy data, password management data, and sessions of the Access Manager.

The policy store database, by default, stores the following data:

- Policy data, including authentication modules and schemes, Application Domains, and policies.
- Password Management data, which includes password policy type for each configured User Identity store as well as the policy that governs password requirements, expiry, notification,
- Sessions, as a persistent backup to distributed in-memory storage

Note:

The preferred mode for audit data storage in production environments is writing audit records to a stand-alone RDBMS database for audit data only. This is done using a separately configured audit store. The policy store is not used for audit data.

See Also:

["Managing the Policy and Session Database "](#)

5.5.2 About Database Deployment

Oracle requires a single database as the policy store in production environments. This single database can also be used to store session data.

Using the database as the session store provides greater scalability and fault-tolerance (against a power event taking all servers down).

Note:

You can have up to two databases: one policy database and one session database. Access Manager is agnostic with respect to the actual back end repository and does not manage this policy store configuration directly.

The policy database must be installed according to vendor instructions. The policy database is configured for use in a Oracle WebLogic Server domain using Oracle

Fusion Middleware Configuration Wizard and policy store Database configuration template.

During initial deployment with the WebLogic Configuration Wizard, the following database details are requested:

- Database login ID and password
- Database Service name and location

An Administrator must extend the database with the Access Manager-specific schema using RCU, as described in *Oracle Fusion Middleware Installation Guide for Oracle Identity and Access Management*. Basic schema creation occurs when the RCU is invoked. The RCU prepares the database to accept Access Manager policy, password management, and session data.

Using the WebLogic Configuration Wizard you can register and test the connection to the database.

Actual Access Manager policy elements are created the first time the WebLogic AdminServer is started with the Oracle Access Management Console deployed.

See Also:

Oracle Fusion Middleware Installation Guide for Oracle Identity and Access Management

5.5.3 Configuring a Separate Database for Access Manager Sessions

Access Manager includes a data source named `oamDS` which is configured against the database instance extended with the Access Manager Schema.

The following pre-defined Java Naming and Directory Interface (JNDI) names are used by the OAM Server to refer the data source.

`jdbc/oamds` (used by both the policy layer and session layer to access database)

You can use the following procedure to create a separate database instance for session data using the WebLogic Administration Console. There is no support for this action in the Oracle Access Management Console.

Note:

In this rare instance, Oracle recommends that you carefully edit `oam-config.xml` as described in Step 2f.

1. Install and configure the database for session data and then use RCU with the Access Manager-specific schema to set up the database as a session data store.
2. Create a new Data Source instance for session data:
 - a. From the WebLogic Administration Console, Domain Structure panel, expand the domain name, Services node.
 - b. Expand JDBC, Data Source.
 - c. Create a new Data Source with the JNDI name `jdbc/oamsession`.

- d. Save the changes.
- e. Stop the OAM Servers and the AdminServer to avoid potential loss of data during the next step.
- f. In `oam-config.xml`, edit the value of the `DataSourceName` attribute to the one configured in step 1. For example:

```
domain-home/config/fmwconfig/oam-config.xml
```

From:

```
<Setting Name="SmeDb" Type="htf:map">
  <Setting Name="URL" Type="xsd:string">jdbc:oracle:thin://amdb.example.
    com:2001/AM</Setting>
  <Setting Name="Principal" Type="xsd:string">amuser</Setting>
  <Setting Name="Password" Type="xsd:string">password</Setting>
  <Setting Name="DataSourceName" Type="xsd:string">jdbc/oamds</Setting>
</Setting>
```

To:

```
<Setting Name="SmeDb" Type="htf:map">
  <Setting Name="URL" Type="xsd:string">jdbc:oracle:thin://amdb.example.
    com:2001/AM</Setting>
  <Setting Name="Principal" Type="xsd:string">amuser</Setting>
  <Setting Name="Password" Type="xsd:string">password</Setting>
  <Setting Name="DataSourceName" Type="xsd:string">jdbc/oamsession</Setting>
</Setting>
```

3. Restart AdminServer and OAM Servers.

5.6 Introduction to Oracle Access Management Keystores

A Java keystore is set up to be used for certificates for Simple or Certificate-based communication between OAM Servers and Webgates during authorization. The keystore bootstrap also occurs on the initial AdminServer startup after running the Configuration Wizard.

This section provides the following topics:

- [Access Manager Security Keys and the Embedded Java Keystore](#)
- [Access Manager Keystores](#)
- [Identity Federation Keystore](#)

5.6.1 Access Manager Security Keys and the Embedded Java Keystore

Keystores are created and configured during Access Manager installation. The password and the key entries password were randomly generated.

The preferred keystore format is JKS (Java keystore). A Java keystore is associated with Access Manager behind the scenes and is used to store cryptographic security keys that are generated to encrypt agent traffic and session tokens:

- Every OAM Agent and OSSO Agent has a secret key that other agents cannot read.
- There is a key to encrypt Oracle Coherence-based session traffic.

- During agent and application registration, a key is generated for encrypting and decrypting SSO Cookies (for Webgates and mod_osso).

Administrators use the Oracle-provided `importcert` tool for several different procedures related to keystores, keys, and certificates, as described in [Securing Communication](#).

The WLST `resetKeystorePassword` method allows you to set the `.oamkeystore` password and any key entries with a password identical to the `.oamkeystore` password to a new value. See *WLST Command Reference for WebLogic Server*.

[Table 5-5](#) identifies the generated Access Manager cryptographic keys.

Table 5-5 Access Manager Keys and Storage

Keys and Storage	Description
Access Manager Cryptographic keys	<ul style="list-style-type: none"> • One per agent secret key shared between 11g Webgate and OAM Server • One global shared secret key used by all your 10g Webgates • One OAM Server key
Key storage	<ul style="list-style-type: none"> • Agent side: A per-agent key is stored locally in the Oracle Secret Store in a wallet file. Client keystore/<code>scratch/clientTrustStore.jks</code> and <code>/scratch/clientKey.jks</code> can be used. • OAM Server side: <code>.oamkeystore</code> contains a per-agent key, and server key, are stored in the credential store on the server side.

Keystores are not accessible using the Oracle Access Management Console. You can manage keystores and certificates as described in [Securing Communication](#).

See Also:

["Identity Federation Keystore"](#)

- ["About Communication Between OAM Servers and WebGates"](#)
 - *Administering Oracle Fusion Middleware* for details about the SSL automation tool and managing ports for WebLogic Server, Oracle HTTP Server, and Oracle Fusion Middleware
-

5.6.2 Access Manager Keystores

Keystores for Access Manager and Security Token Service are created and configured during the installation of the Access Manger.

[Table 5-6](#) provides a summary of keystores used for Access Manager.

Table 5-6 Keystores for Access Manager and Security Token Service

Keystore	Description
System Keystore / Partner Keystore	The container for keys and certificates associated with OAM Server instances (OAM secret keys and Security Token Service private keys for signing and encryption).
.oamkeystore	<p>The container for keys and certificates that are used to establish trust with partners, clients, and agents. The partner keys and certificates are stored in .oamkeystore with sensitive information encrypted.</p> <p>Only one System Keystore of type JCEKS can be present: .oamkeystore.</p> <p><code>\$DOMAIN_HOME/config/fmwconfig/.oamkeystore</code></p> <p>The certificate alias and password can be configured using the Oracle Access Management Console.</p> <p>See Also:</p> <ul style="list-style-type: none"> Table 43-1 Managing Security Token Service Certificates and Keys
Trust Keystore	The Trust Keystore is used to validate keys and certificates presented by clients to establish trust in entities interacting with OAM Server instances.
amtrustkeystore	<p><code>\$DOMAIN_HOME/config/fmwconfig/amtruststore</code></p> <p>amtruststore is created during installation, and must include at least one trusted anchor.</p> <p>The Trust Keystore is managed by using the JRE's keytool application. Security Token Service can use a custom trust keystore.</p> <p>See Also:</p> <ul style="list-style-type: none"> "Managing the Trust Anchors Store (amtruststore)" "Using a Custom Trust Anchor Store for Security Token Service"
Certificate Revocation Lists (CRL)	Certificate revocation information lists are stored in a ZIP archive on the filesystem. These are used by OAM Servers when performing CRL-based certificate revocation checking.
amcrl.jar	<p>amcrl.jar contains CRL files in the DER format:</p> <p><code>\$DOMAIN_HOME/config/fmwconfig/amcrl.jar</code></p> <p>The OAM Server defines a notification listener for the Keystores and the CRL Zip file. Any changes to these files causes Security Token Service to reload the keystore/crl-zip at runtime, without requiring any restarts.</p> <p>amcrl.jar is created by installation and can be modified using the Oracle Access Management Console.</p> <p>See Also:</p> <ul style="list-style-type: none"> "Certificate Validation and Revocation" "Managing Certificate Revocation Lists"
Oracle WSM Agent Keystore	The Oracle WSM Agent uses this keystore for various cryptographic operations. For these operations, the Oracle WSM Agent uses the keystore configured for Oracle WSM tasks.
default-keystore.jks	<p>Oracle strongly recommends that the Oracle WSM Agent keystore and the Access Manager and Security Token Service keystore always be different. Otherwise, keys could be available to any modules authorized by OPSS to access the keystore and Access Manager/Security Token Service keys might be accessed.</p> <p>See Also:</p> <p>"About the Oracle Web Services Manager Keystore (default-keystore.jks)"</p>

Table 5-6 (Cont.) Keystores for Access Manager and Security Token Service

Keystore	Description
OPSS Keystore	<p>For special cases where clients use referencing schemes such as SKI (as opposed to a certificate token being received as part of the web service request), the requester's certificates need to be populated in the OPSS Keystore.</p> <p>This is an uncommon scenario that requires manually provisioning keys to the OPSS keystore.</p> <p>See Also:</p> <ul style="list-style-type: none"> • "About Agents and Security Token Service" • Managing Keys and Certificates in <i>Securing Applications with Oracle Platform Security Services</i>.
.cohstore.jks	<p>This is used to store the SSL Key and Certificate that is used to encrypt SSL communication between Coherence nodes. For information on securing Coherence communications, see the <i>Oracle Coherence Security Guide</i>.</p>

5.6.3 Identity Federation Keystore

Identity Federation and Access Manager store key pairs and certificates that are used for digital signatures and encryption operations.

Identity Federation uses keys to:

- Sign outgoing assertions
- Decrypt incoming XML encrypted data contained inside the SAML message

The following keystore is used to store the encryption and signing certificates:

```
$DOMAIN_HOME/config/fmwconfig/.oamkeystore
```

Identity Federation uses CSF to securely store keystore passwords, as well as server credentials such as HTTP Basic Authentication usernames and passwords.

See Also:

- ["About Communication Between OAM Servers and WebGates"](#)
 - ["Defining Keystore Settings for Federation"](#)
-
-

5.7 Integrating a Supported LDAP Directory with Oracle Access Manager

A centralized LDAP store can be enabled for use with Oracle Access Manager post-installation.

Oracle Internet Directory is featured in this discussion however the tasks are the same regardless of your chosen LDAP directory.

Oracle Access Manager addresses each user population and LDAP directory store as an identity domain. Each identity domain maps to a configured LDAP User Identity Store that is registered with Oracle Access Manager. Multiple LDAP stores can be used with each one relying on a different supported LDAP provider.

During initial WebLogic Server domain configuration, the Embedded LDAP is configured as the one and only User Identity Store for Oracle Access Manager. Within

the Embedded LDAP, the Administrators group is created, with `weblogic` seeded as the default Administrator:

- Only the User Identity Store designated as the System Store is used to authenticate Administrators signing in to use the Oracle Access Management Console, remote registration, and custom administrative commands in WLST.
- Users attempting to access an OAM-protected resource can be authenticated against any store, not necessarily the only one designated as the Default User Identity Store.
- Security Token Service uses only the Default User Identity Store. When adding User constraints to a Token Issuance Policy, for instance, the identity store from which the users are to be chosen must be Default User Identity Store.

After registering a User Identity Store with Access Manager, administrators can reference the store in one or more authentication modules, which form the basis for Oracle Access Manager Authentication Schemes and Policies. When you register a partner (either using the Oracle Access Management Console or the remote registration tool), an application domain can be created and seeded with a policy that uses the designated default Authentication Scheme. When a user attempts to access an Oracle Access Manager-protected resource, she is authenticated against the store designated by the authentication module. For more information, see [Introduction to IdM Suite Components Integration](#).

Managing Server Registration

Managed server instances must be registered in order to interact with Oracle Access Management. (In this book, these managed servers are referred to as OAM Servers.) Accomplish this registration task using the Oracle Access Management Console.

You need to familiarize yourself with the following topics to manage server registrations:

- [Before You Register](#)
- [Understanding OAM Server Registration and Management](#)
- [Managing Individual OAM Server Registrations](#)

6.1 Before You Register

Ensure that the environment meets the requirements before you register.

The following environmental considerations should be met:

- A new Managed Server has been added to the domain using either the Oracle WebLogic Server Administration Console or WLST commands.
- The Oracle JRF Template was applied to the Managed Server (or cluster) if needed.

See *Oracle Fusion Middleware Administrator's Guide*.

Oracle recommends that you review the following topic:

See [Understanding OAM Server Registration and Management](#).

6.2 Understanding OAM Server Registration and Management

The Oracle Access Management Console is a Java EE application that must be installed and run on the same computer as the WebLogic Administration Server. Other key applications that run on the WebLogic Administration Server include the WebLogic Server Administration Console and Enterprise Manager for Fusion Middleware Control.

The Oracle Access Management Console might be referred to as the OAM Administration Server. However, this is not a peer of the OAM Server deployed on a WebLogic Managed Server.

The Oracle Access Management runtime instance deployed on Oracle WebLogic Managed Servers is referred to as an OAM Server. Each OAM Server must be registered with Access Manager to enable communication with registered agents during authentication, authorization, and resource access.

Administrators can extend the WebLogic Server domain and add more OAM Server instances whenever needed, using either:

- The WebLogic Server Administration Console, after which you manually register the OAM Server instance using the Oracle Access Management Console
- The WebLogic Configuration Wizard
- Customized Oracle WebLogic Scripting Tool (WLST) commands as described in *WLST Command Reference for WebLogic Server*

The last two methods automatically register the OAM Server instance, which appears in the Oracle Access Management Console; no additional steps are required.

See Also:

Oracle Fusion Middleware Installation Guide for Oracle Identity and Access Management.

This section introduces OAM Server instance registration and management using the Oracle Access Management Console:

- [About Individual OAM Server Registrations](#)
- [About the Embedded Proxy Server and Backward Compatibility](#)
- [About 11g SSO, Legacy 10g SSO in Combination with OSSO 10g](#)
- [About Communication Between OAM Servers and WebGates](#)

See Also:

[Features Not In Access Manager 11.1.2.3.0](#) for a comparison of Access Manager 11g versus Oracle Access Manager 10g.

6.2.1 About Individual OAM Server Registrations

Administrators can add one or more Managed Servers to the WebLogic Server domain for Oracle Access Management.

When using the WebLogic Configuration Wizard, the OAM Server is automatically registered. However, if the configuration wizard was not used, the OAM Server must be registered manually to open a communication channel.

Alternatively. You can use custom WLST commands for OAM to display, edit, or delete a server registration. Any changes are automatically propagated to the Oracle Access Management Console and to every OAM Server in the cluster.

See Also:

WLST Command Reference for WebLogic Server

Only OAM Servers are registered with Oracle Access Management. The Oracle Access Management Console (on the WebLogic Administration Server) is not registered with itself.

Regardless of the method used to register an OAM Server, details for each instance are located on the System Configuration tab, Common Configuration section in the Oracle Access Management Console, including:

- Server name, Host, Port
- Proxy: Performs as the legacy Access Server and defines the communication security mode. For more information, see:
 - [About the Embedded Proxy Server and Backward Compatibility](#)
 - [About 11g SSO, Legacy 10g SSO in Combination with OSSO 10g](#)
 - [About Communication Between OAM Servers and WebGates](#)
- Oracle Coherence: Provides a distributed cache for various OAM services, including session data.

Administrators can search for a specific instance registration, register a newly installed OAM Server, view, modify, or delete server registrations using the Oracle Access Management Console. For more information, see "[OAM Server Registration Page](#)".

6.2.2 About the Embedded Proxy Server and Backward Compatibility

Oracle Access Management server-side components include Proxy servers to maintain backward compatibility with Oracle Access Manager 10g policy-enforcement agents (10g Webgates and Access Clients) and OracleAS SSO 10g mod_osso (known as OSSO Agents in 11g), as well as OpenSSO Agents.

Legacy 10g SSO: The OAM Proxy can accept requests from multiple Access clients concurrently and enables all Webgates and AccessGates (known as Access Clients in 11g) to interact with Access Manager. For more information, see "[OAM Proxy Settings](#)".

Legacy OracleAS 10g (OSSO): The integrated OSSO proxy handles token generation and validation in response to token requests during authentication using OSSO Agents with Access Manager. The OSSO proxy needs no configuration. Simply register the OSSO agent as described in [Introduction to Agents and Registration and Registering and Managing OAM 11g Agents](#).

See Also:

["About 11g SSO, Legacy 10g SSO in Combination with OSSO 10g"](#)

6.2.3 About 11g SSO, Legacy 10g SSO in Combination with OSSO 10g

You can upgrade OracleAS SSO to use Access Manager SSO when you have a legacy deployment where Oracle Access Manager 10g is integrated and used in combination with OracleAS (OSSO) 10g.

After upgrading OSSO to use Access Manager 11g, you can have 10g Webgates operating with Access Manager 11g SSO the same deployment. In this situation, the OAM Proxy forwards requests to either the 10g Access Server or to Access Manager 11g as needed.

The Oracle Access Manager 10g ObSSOCookie is an encrypted session-based single sign-on cookie that is generated when a user authenticates successfully. The 10g ObSSOCookie stores user identity information, which you can cache if needed.

The integrated OAM Proxy supports the AES encryption algorithm of the 10g ObSSOCookie to enable backward compatibility with release 10g Webgates. The 10g Access Server can decrypt the cookie created by the OAM Proxy (and vice versa). This allows Access Manager 11g to perform authentication and Oracle Access Manager 10g to perform authorization (and vice versa).

Note:

An Access Manager 11g ObSSOCookie created by OAM Proxy is compatible with the 10g ObSSOCookie created by Access Server.

For more information, see "[OAM Proxy Settings](#)".

6.2.4 About Communication Between OAM Servers and WebGates

The OAM Server communication mode can be changed after a successful agent registration. The Webgate mode needs to be at the same level as the OAM Server mode or higher for the server to continue communicating with the agent.

Communication modes for the OAP channel include:

- **Open:** Use this unencrypted mode if communication security is not an issue in your deployment.
- **Simple:** Use this Oracle-signed certificate mode if you have some security concerns, such as not wanting to transmit passwords as plain text, but you do not manage your own Certificate Authority (CA).
- **Cert:** Use if you want different certificates on OAM Servers and WebGates and you have access to a trusted third-party CA.

On each individual OAM Server registration, the security mode is defined on the Proxy tab, as described in "[OAM Server Registration Page](#)".

Simple and Cert modes also require:

- Security passwords that are common to all OAM Servers and WebGates, as described in "[Managing the Access Protocol for OAM Proxy Simple and Cert Mode Security](#)".
- Appropriately signed X.509 digital certificates, as described in [Securing Communication](#).

At least one OAM Server instance must be running in the same mode as the agent during agent registration. Otherwise, agent registration fails. After agent registration, however, you can change the communication mode of the OAM Server.

Communication between the agent and server would continue to work as long as the Webgate mode is at least at the same level as the OAM Server mode or higher. The agent mode can be higher but cannot be lower. For example, if OAM Server mode is Open, agents can communicate in any of the three modes. If OAM Server mode is Simple, agents can use Simple or Cert mode. If OAM Server mode is Cert, agents must use Cert mode.

See Also:

[Securing Communication](#)

6.2.5 Conditions Requiring Server Restart

Most Oracle Access Management functional services take up changes made through the Oracle Access Management Console without restarting OAM Server.

[Table 6-1](#) identifies conditions that do require a server restart.

Table 6-1 Conditions Requiring Server Restart

Event	Description
Session persistence change	A change from database to in-memory (or vice versa) session persistence requires an OAM Server restart.
Oracle Coherence port number	A change to the port number requires an OAM Server restart.
Load balancer server definition	A change requires an OAM Server restart.
Managed Server port number	A change requires an OAM Server restart.
New Managed Server	Adding a new managed server to the cluster requires restarting the AdminServer to policy enable uptake. OAM Servers must be restarted to reinitialize Oracle Coherence security configuration with the new server included.

6.3 Managing Individual OAM Server Registrations

OAM Server instances can be registered and managed using the Oracle Access Management Console.

Topics here include:

- [OAM Server Registration Page](#)
- [Registering a Fresh OAM Server Instance](#)
- [Viewing or Editing Individual OAM Server Registrations and Proxy Settings](#)
- [Deleting an Individual Server Registration](#)

6.3.1 OAM Server Registration Page

Users with valid Administrator credentials can register a freshly installed Managed Server (OAM Server instance) or modify an existing OAM Server registration using the Oracle Access Management Console.

Alternatively: You can use custom WLST commands to register and manage OAM Server instances. Changes are reflected in the Oracle Access Management Console and are automatically propagated to every OAM Server in the cluster.

See Also:

WLST Command Reference for WebLogic Server

Figure 6-1 illustrates a typical OAM Server registration page when viewed within the Oracle Access Management Console. To access the OAM Server registration page using the Oracle Access Management Console, click Configuration in the top right of the console and then click the Server Instances link on the Configuration page. From the resulting Server Instances search page, click Create in the Search Results table to display the Create: OAM Server page. See [Registering a Fresh OAM Server Instance](#) for details on how to configure this page.

Figure 6-1 OAM Server Registration Page with Proxy Tab Displayed

The screenshot shows the 'Create: OAM Server' configuration page. At the top, there is a breadcrumb 'Configuration >' and a title 'Create: OAM Server' with a sub-label 'OAM Server Instance' and an 'Apply' button. The form contains several sections:

- Server Name**: A text input field.
- Host**: A text input field.
- Port**: A numeric input field with up and down arrows.
- OAM Proxy**: A section with a dropdown arrow, containing:
 - Proxy Server Id**: A text input field.
 - Port**: A numeric input field with '0' and up/down arrows.
 - Mode**: A dropdown menu.
- Coherence Configuration**: A section with a dropdown arrow, containing:
 - Log Level**: A numeric input field with '3' and up/down arrows.
 - Local Port**: A numeric input field with '9095' and up/down arrows.
 - Log Limit**: A numeric input field with '4096' and up/down arrows.

Individual server registration settings are described in [Table 6-2](#).

Table 6-2 OAM Server Instance Settings

Element	Definition
Server name	The identifying name for this server instance, which was defined during initial deployment in the WebLogic Server domain.
Host	The full DNS name (or IP address) of the computer hosting the server instance. For example: <i>host2.domain.com</i> .
Port	The port on which this server communicates (listens and responds). Default: 5575 Note: If both the SSL and Open ports of the Managed Server are enabled, then the Managed Server is set to the SSL port by default. If you must use the non-SSL port, the credential collector URL of the authentication scheme must be set to the absolute URL which points to <code>http</code> as the protocol and non-SSL port. See Also: Securing Communication
Proxy	See "OAM Proxy Settings"
Coherence	See " Coherence Settings for Individual Servers "

See Also:

["Managing Individual OAM Server Registrations"](#)

6.3.1.1 OAM Proxy Settings

An integrated proxy server (OAM Proxy) is installed with each Managed Server for OAM Server. The OAM Proxy is used as a legacy Access Server to provide backward compatibility for 10g Agents that are registered with Access Manager 11g. The Agent can be freshly installed or currently operating within an Oracle Access Manager 10g SSO deployment.

Each OAM Proxy instance requires a different port. The proxy starts listening when the application starts. Registered access clients can immediately communicate with the proxy.

The OAM Proxy handles both configuration and run-time events. Each OAM Proxy can accept requests from multiple access clients concurrently. Each OAM Proxy enables access clients to interact with Access Manager 11g. This includes:

- 10g (10.1.4.3) WebGates
- 10g (10.1.4.2.0) WebGates
- 10g (10.1.4.0.1) WebGates
- 11g WebGates (needs no proxy)

Note:

For Access Clients, Access Manager 11g provides authentication and authorization functionality only. Policy modification through Access Clients is not supported.

OAM Proxy settings are documented in [Table 6-3](#).

Table 6-3 OAM Proxy Settings for an Individual OAM Server

OAM Proxy Setting	Value
Port	The unique port on which this OAM Proxy instance is listening. On a default installation, the port is 5575.
Proxy Server ID	The identifier of the computer on which the OAM Proxy (and this OAM Server instance) resides. DNS hostname is preferred; however, you can use any valid and relevant string. On a default installation, the Proxy Server ID is AccessServerConfigProxy.

Table 6-3 (Cont.) OAM Proxy Settings for an Individual OAM Server

OAM Proxy Setting	Value
Mode	<p>OAM channel transport security for the OAM Proxy can be one of the following (the agent mode must match during registration and can be higher after registration):</p> <ul style="list-style-type: none"> • Open: No encryption. • Simple: The data passed between the OAM Agent and OAM Server is encrypted using OAM self-signed certificates. Before specifying Simple mode, you must specify the global passphrase. • Cert: The data between the OAM Agent and OAM Server is encrypted using Certificate Authority (CA) signed X.509 certificates. <p>Note: Before specifying Cert mode, you must acquire signed certificates from a trusted third party Certificate Authority.</p> <p>On a default installation, the Mode is Open.</p> <p>Note: Simple and Cert transport security modes are governed by information defined on the OAM Server Common Properties OAM Proxy tab, as described in "Managing the Access Protocol for OAM Proxy Simple and Cert Mode Security".</p> <p>See Also: Securing Communication if you are configuring Simple or Cert transport security modes.</p>

OAM Proxy Logging: Oracle Access Management services use the same logging infrastructure as any other Oracle Fusion Middleware 11g component, as described in [Auditing Administrative and Run-time Events](#). However, OAM Proxy uses Apache log4j for logging.

6.3.1.2 Coherence Settings for Individual Servers

Coherence provides replicated and distributed (partitioned) data management and caching services on top of a reliable, highly scalable peer-to-peer clustering protocol. Coherence has no single points of failure; it automatically and transparently fails over and redistributes its clustered data management services when a server becomes inoperative or is disconnected from the network.

When a new server is added, or when a failed server is restarted, it automatically joins the cluster and Coherence fails back services to it, transparently redistributing the cluster load. Coherence includes network-level fault tolerance features and transparent soft re-start capability to enable servers to self-heal.

Coherence modules consist of the values, and types for the individual server instance, as shown in [Figure 6-1](#).

WARNING:

Oracle recommends that you do not modify Oracle Coherence settings for an individual server unless you are requested to do so by an Oracle Support Representative.

Table 6-4 Default Coherence Settings for Individual OAM Servers

Coherence Module	Type of Entry	Description and Default Values
LogLevel	String	The Coherence log level (from 0 to 9) for OAM Server events.
LogPort	int (integer)	The listening port for Coherence logging on the WebLogic Server.
LogLimit	String	The Coherence log limit

Coherence Logging: Appears only in the WebLogic Server log. There is no bridge from Oracle Coherence logging to Oracle Access Management logging. For Oracle Fusion Middleware 11g logging infrastructure details, see [Logging Component Event Messages](#) .

6.3.2 Registering a Fresh OAM Server Instance

Users with valid Administrator credentials can register a new Managed Server (OAM Server) instance using the Oracle Access Management Console. Each OAM Server must be registered to communicate with agents.

Before you begin, the new Managed Server instance must be configured in the Oracle WebLogic Server domain, but not yet started.

1. Install the new Managed Server instance and configure it in the Oracle WebLogic Server domain, but do not start this instance.
2. Log in to the Oracle Access Management Console and click **Configuration** in the top bar.
3. In the Configuration console, click **Server Instances**.
4. In the tab that appears, click **Create OAM Server**.

The OAM Server registration page illustrated in [Figure 6-1](#) is displayed.

5. On the Create: OAM Server page, enter details for your instance, as described in [Table 6-2](#):
 - Server name
 - Host
 - Port
6. Proxy: Enter or select details for this OAM Proxy instance, as described in [Table 6-3](#):
 - Port
 - Proxy Server ID
 - Mode (Open, Simple, or Cert)

See Also:

[Securing Communication](#) if you are using Simple or Cert mode

7. Coherence: Oracle recommends that you do not modify Oracle Coherence settings for an individual server instance unless you are requested to do so by an Oracle Support Representative.

See Also:

["Using Coherence "](#)

8. Click **Apply** to submit the configuration, which should appear in the navigation tree (or close the page without applying changes).
9. Start the newly registered server.

See Also:

- *Oracle Fusion Middleware Installation Guide for Oracle Identity and Access Management*
 - ["OAM Server Registration Page "](#)
-
-

6.3.3 Viewing or Editing Individual OAM Server Registrations and Proxy Settings

Users with valid Administrator credentials can view or modify settings for an individual server instance using the Oracle Access Management Console. For instance, you might need to change the listening port or the Proxy communication transport security mode.

Changes made are immediately visible in the Oracle Access Management Console and propagated to all OAM Servers in the cluster.

See Also:

- ["OAM Server Registration Page "](#)
 - *WLST Command Reference for WebLogic Server*
 - *Moving Identity Management to a New Production Environment in the Administering Oracle Fusion Middleware*
-
-

1. At the top of the Oracle Access Management Console, click **Configuration**.
2. In the Configuration console, click **Server Instances**.
3. In the page that appears, click **Search**, then double-click the target instance to display its configuration, and then proceed as follows:
 - **View Only:** Close the page when you finish viewing details.

- **Modify:** Perform remaining steps to edit the configuration.
4. On the OAM Server page, change details for your instance, as described in [Table 6-2](#).
 5. **Proxy:** Change details for this OAM Proxy instance, as described in [Table 6-3](#).

See Also:

[Securing Communication](#) if you are using Simple or Cert mode

6. **Coherence:** Oracle recommends that you do not modify Oracle Coherence settings for an individual server instance unless you are requested to do so by an Oracle Support Representative.

See Also:

["Using Coherence "](#)

7. Click **Apply** to submit the changes (or close the page without applying change).

6.3.4 Deleting an Individual Server Registration

Users with valid Administrator credentials can delete an OAM server registration, effectively disabling it.

To delete:

1. At the top of the Oracle Access Management console, click Configuration.
2. In the Configuration console, click Server Instances.
3. In the tab that appears, double-click the target instance to confirm its details, then close the tab.
4. In the list of instances, select the target instance, click **Delete** in the tool bar, and confirm removal in the dialog that appears.
5. Confirm that the instance has been removed from the instance list.
6. Remove the deleted instance from the WebLogic Server Administration Console.

The Node Manager on Managed Server host handles the rest automatically.

Part III

Logging, Auditing, Reporting and Monitoring Performance

Administrators can log component and WebGate event messages, audit administrative and run-time events, and performance monitoring for Oracle Access Management services.

This section contains the following chapters:

- [Logging Component Event Messages](#)
- [Auditing Administrative and Run-time Events](#)
- [Logging WebGate Event Messages](#)
- [Understanding Oracle Access Management Reports](#)
- [Monitoring Oracle Access Management Performance and Access Manager Health](#)
- [Monitoring Performance and Logs with Fusion Middleware Control](#)

Logging Component Event Messages

Logging is the mechanism by which components and services write messages to a log file in order to capture critical component events, processes, and state information. Administrators can configure logging to provide information at various levels of granularity using the same logging infrastructure and guidelines as any other component in Oracle Fusion Middleware 11g: `java.util.logging` (standard and available in all Java environments).

Configuring logging and locating log files are the focus of this chapter which contains the following sections.

- [About Oracle Access Management Logging](#)
- [Logging Component Event Messages](#)
- [Configuring Logging for Access Manager](#)
- [Configuring Logging for Security Token Service and Identity Federation](#)
- [Mobile and Social Logging](#)
- [Logging for the Access Portal Service](#)
- [Validating Run-time Event Logging Configuration](#)

7.1 About Oracle Access Management Logging

The logging system writes output to flat files only. Logging to an Oracle Database instance is not supported. Unless explicitly stated, information in this chapter is the same whether using any of the services in Oracle Access Management.

Additionally:

- You can use a custom Oracle WebLogic Scripting Tool (WLST) command to change logging levels.
- Diagnosing problems using the information in log files is outside the scope of this chapter.
- Before you can perform tasks in this chapter ensure that the Oracle Access Management Console and a managed OAM Server are running.

Oracle also recommends that you review [Managing Server Registration](#).

7.2 Logging Component Event Messages

The logging infrastructure records messages that can be used for problem diagnosis. Security Token Service is a J2EE Web application, part of the Access Manager J2EE Application. Both use OJDL for logging purposes. Security Token Service captures the interactions between itself and Partners with timestamps. The Administrator controls

the amount of information that is logged in a message by specifying log levels for each component for which a logger is defined.

Generally, you enable logging to produce files that you send to Oracle Technical Support for problem diagnosis. Documentation for log messages is not available. In some cases, you might be able to diagnose problems on your own by reading log files.

Oracle Access Management makes use of the files in [Table 7-1](#).

Table 7-1 Logging Files

File Type	Description
Logging Configuration File	Provides logging level and other configuration information for logging. This file is stored in the following path: <code>\$DOMAIN_HOME/config/fmwconfig/servers/SERVER-NAME/logging.xml</code> Note: By default, Security Token Service and Identity Federation messages are logged in the OAM Server's log file. However, for convenience, you can edit logging.xml to direct Security Token Service or Identity Federation information to a separate log file, as described in " Configuring Logging for Security Token Service and Identity Federation ".
Log File	Logged information is stored in the following location: <code>\$DOMAIN_HOME/servers/SERVER-NAME/logs/ SERVER-NAME-diagnostics.log</code>

Oracle Access Management uses the WebLogic container's logging defaults in [Table 7-2](#).

Table 7-2 Logging Defaults

Log Type	Description
Events	The following events are logged automatically: <ul style="list-style-type: none"> • OAM Server events (managed run-time servers) • Administrative events (generated for configuration changes made using the console)
Levels	By default, the log level for all Oracle Access Management components is the Notification level. Logging at the Error level produces a small amount of output while other log levels can result in voluminous logging output, which can impact performance. In production environments, logging is usually either disabled or the log level is set to a level that results in a small volume of logging output (the error level, for example).

For more information, see:

- [Component Loggers for Security Token Service and Access Manager](#)
- [Sample Logger and Log Handler Definition](#)
- [About Logging Levels](#)

See Also:

- [Monitoring Performance and Logs with Fusion Middleware Control](#) for details about how you can configure and view logs using Fusion Middleware Control
- Logging information in the *Securing Applications with Oracle Platform Security Services*

7.2.1 Component Loggers for Security Token Service and Access Manager

The component loggers for Security Token Service and Access Manager are different.

Security Token Service has only a single logger: oracle.security.fed. For more information, see "[Configuring Logging for Security Token Service and Identity Federation](#)".

Each Access Manager component is associated with its own logger name, as listed in the following tables:

- [Table 7-3](#)
- [Table 7-4](#)
- [Table 7-5](#)

Table 7-3 Oracle Access Management Server-Side Component Loggers

Component Name	OAM Logger Name	Description
Protocol Binding	oracle.oam.binding	Responsible for marshalling/unmarshalling wire protocol request and response to a Java Object representation
SSO Controller	oracle.oam.controller.sso	Responsible for managing the user session lifecycle and orchestrating the SSO and logout flows
OAM Proxy	oracle.oam.proxy.oam	Responsible for interacting with OAM Webgates by marshalling/unmarshalling OAP protocol requests and responses and performing the data/message transformation necessary to help the OAM Server process OAP requests/responses
OSSO Proxy	oracle.oam.proxy.osso	Responsible for interacting with OSSO Agents by marshalling/unmarshalling requests and responses and doing the data/message transformation necessary to help the OAM Server process mod_osso requests/responses
OpenSSO Proxy	oracle.oam.proxy.opensso	Responsible for interacting with OpenSSO Web and Java Agents by marshalling/unmarshalling requests and responses and performing the data/message transformation necessary to help the OAM Server process OpenSSO agent requests/responses
Credential Collector	oracle.oam.credcollector	Responsible for interacting with the user to acquire the necessary information required by the Authentication Scheme
Remote Registration of Partners	oracle.oam.engine.remotereg	Responsible for registering partners with the OAM Server and managing associated protected policies

Table 7-3 (Cont.) Oracle Access Management Server-Side Component Loggers

Component Name	OAM Logger Name	Description
Oracle Access Management Console	oracle.oam.admin.console	Console that supports administration and monitoring of the Access Management deployment
Admin-Service Config	oracle.oam.admin.service.config	Module used by the UI Console to manage the configuration
Diagnostics and Monitoring	oracle.oam.diagnostics	Provides instrumentation used by the OAM Server components to enable Diagnostic and Monitoring

Table 7-4 Oracle Access Management Shared-Service Engine Component Loggers

Component Name	OAM Logger Name	Description
Authentication Engine	oracle.oam.engine.authn	Supports establishing the identity of the user by validating the credentials and other data as required by the specified Authentication scheme
Policy Service Engine	oracle.oam.engine.policy	Supports management of Authentication, Authorization and Token Issuance Policies. In addition, it also provide a policy decision service to support runtime processing
Session Management Engine	oracle.oam.engine.session	Supports managing user session and token context information with support for user/administrator-initiated and time-out based events
Token Engine	oracle.oam.engine.token	Supports managing the entire token life cycle from generation to cancellation
SSO Engine	oracle.oam.engine.sso	Supports the single sign-on experience by managing the lifecycle of the user login session(s)
PartnerTrustMetadata Engine	oracle.oam.engine.ptmetadata	Supports management of partner metadata and trust information
Authorization Engine	oracle.oam.engine.authz	Wrapper that provides methods that map directly to OAP runtime request operations

Table 7-5 Oracle Access Management Foundation API Component Loggers

Component Name	OAM Logger Name	Description
Session Access	oracle.oam.session.access	** Not useful unless your are decompiling code
Session Access Implementation	oracle.oam.session.accessimpl	** Not useful unless your are decompiling code

Table 7-5 (Cont.) Oracle Access Management Foundation API Component Loggers

Component Name	OAM Logger Name	Description
Policy Access	oracle.oam.policy.access	** Not useful unless your are decompiling code

7.2.2 Sample Logger and Log Handler Definition

Here is a sample logger and a log handler for Access Manager only.

Security Token Service has only one logger and log handler, as described in ["Configuring Logging for Security Token Service and Identity Federation"](#).

Following example illustrates the configuration of an Access Manager logger and a log handler in the file `logging.xml`.

```
<logging_configuration>

  <log_handlers>
    <log_handler name='oam-handler' class='oracle.core.ojdl.logging.
      ODLHandlerFactory'>
      <property name='path' value='oam/diagnostic' />
      <property name='maxFileSize' value='10485760' />
      <property name='maxLogSize' value='104857600' />
    </log_handler>
  </log_handlers>

  <loggers>
    <logger name='oracle.security.am' level='NOTIFICATION:1'>
      <handler name='oam-handler' />
      ...
    </logger>
  </loggers>

</logging_configuration>
```

See Also:

For more information about Java EE application logging, see Appendix I, section I.1.1, in *Securing Applications with Oracle Platform Security Services*.

7.2.3 About Logging Levels

In Oracle Access Management, the amount of data output by a logger is controlled by its level; the higher the level, the more information is logged.

The level of a logger is specified with the element `<logger>` in the file `logging.xml` with the following format:

```
<logger name="loggerName" level="notifLevel"/>
```

where `loggerName` is a logger name (see ["Component Loggers for Security Token Service and Access Manager"](#)), and `notifLevel` is either an ODL message level or a Java message level.

Table 7-6 shows the correspondence between ODL message levels and Java message levels, in increasing order:

Table 7-6 Mapping of ODL to Java Levels

ODL Message Level	Java Message Level
INCIDENT_ERROR:1	SEVERE.intValue()+100
ERROR:1	SEVERE (logs exceptions)
WARNING:1	WARNING (logs exceptions)
NOTIFICATION:1	INFO (default)
NOTIFICATION:16	CONFIG
NOTIFICATION:32	INFO and CONFIG
TRACE:1	FINE (occasionally recommended in production environments)
TRACE:16	FINER (not recommended in production environments)
TRACE:32	FINEST (not recommended in production environments)

Any other Java level value not listed above (that is, one outside the interval [SEVERE.intValue()+100 - FINEST] is mapped to the ODL level UNKNOWN.

Note:

If you define a filter to log messages at the finest level for the oracle.security.fed package and sub-package (classes for Security Token Service), after restarting the server you would see logs for the OAM Server. For more information, see "[Configuring Logging for Security Token Service and Identity Federation](#)".

7.3 Configuring Logging for Access Manager

Graphical user interface is not available to change logger levels, only WLST commands can be used.

This section describes tasks only for Access Manager.

See Also:

["Configuring Logging for Security Token Service and Identity Federation"](#)

This section provides the following topics:

- [Modifying the Logger Level for Access Manager](#)
- [Adding an Access Manager-Specific Logger and Log Handler](#)

7.3.1 Modifying the Logger Level for Access Manager

Administrators can use custom WLST commands for Access Manager to change logger settings.

Your deployment and choices will be different.

Note:

Use the WLST command `help("fmw_diagnostics")`.

See Also:

WLST Command Reference for WebLogic Server

Follow this procedure to modify the OAM logger level.

1. Confirm that the OAM Server is running.
2. Acquire the custom WLST script for Access Manager. For example:

```
$ORACLE_HOME/common/bin/wlst.sh
```

3. Connect to the WebLogic Server and log in as the WebLogic Administrator. For example:

```
connect([username, password])
```

4. List available loggers for the OAM Server. For example:

```
wls:/base_domain/serverConfig> listLoggers(pattern="oracle.oam.*",
target="oam_server1")
```

```
wls:/WLS_IDM/serverConfig> listLoggers(pattern="oracle.oam.*",
target="oam_policy_mgr1")
```

Here `pattern=` represents the `oam.controller` component and `target=` represents the desired OAM Server as it was specified during registration.

5. View the list of Access Manager loggers associated with this OAM Server. For example:

Logger	Level
oracle.oam	<Inherited>
oracle.oam.admin.foundation.configuration	<Inherited>
oracle.oam.agent-default	<Inherited>
oracle.oam.audit	<Inherited>
oracle.oam.binding	<Inherited>
oracle.oam.commonutil	<Inherited>
oracle.oam.config	<Inherited>
oracle.oam.controller	<Inherited>
oracle.oam.default	<Inherited>
oracle.oam.diagnostic	<Inherited>
oracle.oam.engine.authn	<Inherited>
oracle.oam.engine.authz	<Inherited>

```

oracle.oam.engine.policy          | <Inherited>
oracle.oam.foundation.access     | <Inherited>
oracle.oam.idm                   | <Inherited>
oracle.oam.idm                   | <Inherited>
oracle.oam.idm                   | <Inherited>
oracle.oam.user.identity.provider | <Inherited>

```

6. Modify the log level based on your requirements. For example, this sequence changes the log level of the oam.controller to TRACE:32 with no persistence:

```

wls:/base_domain/serverConfig> domainRuntime()
wls:/base_domain/domainRuntime> setLogLevel(logger="oracle.oam.controller",
level="TRACE:32", persist="0", target="oam_server1")

wls:/WLS_IDM/domainRuntime> setLogLevel(logger="oracle.oam", level="TRACE:32",
persist="0", target="oam_policy_mgr1")

```

7. Repeat step 4 to list the loggers again and verify the log level change. For example:

```

wls:/base_domain/serverConfig> listLoggers(pattern="oracle.oam.*",target="oam_
server1")

```

Logger	Level
oracle.oam	<Inherited>
oracle.oam.admin.foundation.configuration	<Inherited>
oracle.oam.agent-default	<Inherited>
oracle.oam.audit	<Inherited>
oracle.oam.binding	<Inherited>
oracle.oam.commonutil	<Inherited>
oracle.oam.config	<Inherited>
oracle.oam.controller	TRACE:32
oracle.oam.default	<Inherited>
oracle.oam.diagnostic	<Inherited>
oracle.oam.engine.authn	<Inherited>
oracle.oam.engine.authz	<Inherited>
oracle.oam.engine.policy	<Inherited>
oracle.oam.foundation.access	<Inherited>
oracle.oam.idm	<Inherited>
oracle.oam.idm	<Inherited>
oracle.oam.idm	<Inherited>
oracle.oam.user.identity.provider	<Inherited>

8. Verify the generated log file to confirm the controller is logged at the TRACE:32 level:

```
$DOMAIN_HOME/server/SERVER_INSTANCE_NAME/logs/
```

9. Proceed to "[Validating Run-time Event Logging Configuration](#)".

7.3.2 Adding an Access Manager-Specific Logger and Log Handler

Administrators can use the following procedure to specify a log file path and necessary attributes.

In the following procedure, you will identify the target OAM Server, rotation and retention periods, a path to the log file, the handler, and logger. Your deployment and choices will be different.

Note:

Use the WLST command `help("fmw_diagnostics")` to get more information.

Skip steps 1 through 3 if the following items are true:

- The OAM Server is running
- You have the WLST script
- You have connected to the server and logged in

See Also:

Customization Commands in *WLST Command Reference for WebLogic Server*

Follow this procedure to specify the OAM logger, level and log handler.

1. Confirm that the OAM Server is running.
2. Acquire the WLST script. For example:

```
$ORACLE_HOME/common/bin/wlst.sh
```

3. Connect to the WebLogic Server and log in as the WebLogic Administrator. For example:

```
sh wlst.sh wls:/offline> connect
```

4. Add an Access Manager logger and level for the OAM Server. For example:

```
wls:/base_domain/serverConfig> domainRuntime()
wls:/base_domain/domainRuntime> setLogLevel(logger="oracle.oam",
level="WARNING", persist="0", target="oam_server1")
```

5. Add a custom log handler and associate it with the Access Manager logger. For example:

```
wls:/base_domain/domainRuntime> configureLogHandler(name="oam-log-handler",
target="oam_server1", rotationFrequency="daily", retentionPeriod="week", path="$
{domain.home}/oamlogs" , maxFileSize = "10485760", maxLogSize = "104857600",
addHandler="true", handlerType="oracle.core.ojdl.logging
.ODLHandlerFactory", addToLogger="oracle.oam")
```

```
wls:/base_domain/domainRuntime>configureLogHandler(name="oam-log-handler",
addProperty="true", propertyName="supplementalAttributes", propertyValue=
"OAM.USER, OAM.COMPONENT", target="oam_server1")
```

6. Verify all the logs in the `$DOMAIN_HOME/oamlogs` directory:

```
$DOMAIN_HOME/oamlogs/
```

7.4 Configuring Logging for Security Token Service and Identity Federation

By default Security Token Service and Identity Federation messages are logged into the OAM Server's log files.

You can view and configure these logs in Fusion Middleware Control. However, you can also edit `logging.xml` and direct Security Token Service and Identity Federation information to a separate log file, as described in this section. The files involved in this procedure are:

- **Logging Configuration File:** Provides logger names and other configuration information for logging. This file is stored in: `$DOMAIN_HOME/config/fmwconfig/servers/SERVER-NAME/logging.xml`.
- **Log File:** `$DOMAIN_HOME/ostslogs/SERVER-NAME-diagnostics.log`, for example.

Security Token Service and Identity Federation do not categorize log handlers as Access Manager does. Instead, there is only one logger that affects the log levels for Security Token Service and Identity Federation. [Table 7-7](#) provides details for this logger, which are required in the WLST command.

Table 7-7 Oracle Security Token Service and Identity Federation Loggers

Component Name	Logger Name	Log Handler Name	Log Class
Security Token Service or Identity Federation	oracle.security.fed	stsfed-handler	class=oracle.core.ojdl.logging.ODLHandlerFactory

For details, see:

- [Configuring Logging for Security Token Service or Identity Federation](#)
- [Defining Log Level and Log Details for Security Token Service or Identity Federation](#)

See Also:

- [Monitoring Performance and Logs with Fusion Middleware Control](#) for details about how you can configure and view logs using Fusion Middleware Control
 - Logging information in the *Securing Applications with Oracle Platform Security Services*
-

7.4.1 Configuring Logging for Security Token Service or Identity Federation

Administrators can separate Security Token Service or Identity Federation log messages from OAM Server message logs.

To configure:

1. Locate and open `logging.xml`: `$DOMAIN_HOME/config/fmwconfig/servers/SERVER-NAME/logging.xml`.

2. Add the following to create the independent message log for Security Token Service and Identity Federation:

```
<log_handler name='stsfed-handler' class='oracle.core.ojdl.logging.ODLHandlerFactory'>
  <property name='path' value='sts/log' />
  <property name='maxFileSize' value='10485760' />
  <property name='maxLogSize' value='104857600' />
</log_handler>

<logger name='oracle.security.fed' level='TRACE:32'>
  <handler name='stsfed-handler' />
</logger>
```

3. Save the file.
4. Proceed with "[Defining Log Level and Log Details for Security Token Service or Identity Federation](#)".

7.4.2 Defining Log Level and Log Details for Security Token Service or Identity Federation

Administrators can use custom WLST commands for Oracle Access Management to change logger settings for Security Token Service as described here. This specifies an independent output file for only Security Token Service log messages.

Use the WLST command `help("fmw_diagnostics")`.

Skip steps 1 through 3 if the following items are true:

- The OAM Server is running
- You have the WLST script
- You have connected to the server and logged in

See Also:

WLST Command Reference for WebLogic Server

This sample procedure for Security Token Service logging is very similar to the one for Access Manager. However, there are a few differences. Your deployment choices will be different.

1. Confirm that the OAM Server is running.
2. Acquire the custom WLST script for Oracle Access Management:

```
$ORACLE_HOME/common/bin/wlst.sh
```

3. Connect to the WebLogic Server and log in as the WebLogic Administrator. For example:

```
sh wlst.sh wls:/offline> connect adminID password
```

4. Modify the log level of `oracle.security.fed` based on your requirements. For example, this sequence changes the log level to WARNING with no persistence:

```
wls:/base_domain/serverConfig> domainRuntime()  
wls:/base_domain/domainRuntime> setLogLevel(logger="oracle.security.fed",  
level="WARNING", persist="0", target="oam_server1")
```

5. Specify the target OAM Server, as well as rotation and retention periods, path to the log file, the handler, and logger. For example:

```
wls:/base_domain/domainRuntime> configureLogHandler(name="osts-log-handler",  
target="oam_server1", rotationFrequency="daily", retentionPeriod="week",  
path="${domain.home}/ostslogs", maxFileSize="10485760", maxLogSize  
="104857600", addHandler="true", handlerType="oracle.core.ojdl.logging.ODL  
HandlerFactory", addToLogger="oracle.security.fed")
```

6. Verify the generated log file to confirm the controller is logged at the WARNING level:

```
DOMAIN_HOME/ostslogs/SERVER-NAME-diagnostics.log  
DOMAIN_HOME/oiflogs/SERVER-NAME-diagnostics.log
```

7. Proceed to "[Validating Run-time Event Logging Configuration](#)".

7.5 Mobile and Social Logging

For information about Fusion Middleware logging, see

Monitoring Oracle Fusion Middleware in the *Oracle Fusion Middleware Administrator's Guide*.

For information about Fusion Middleware auditing, see

Configuring and Managing Auditing in the *Securing Applications with Oracle Platform Security Services* guide.

7.6 Logging for the Access Portal Service

The Access Portal Service logs five events to the Oracle Access Management table.

The five events are:

- CredentialAdded
- CredentialDeleted
- CredentialModified
- Login
- CredentialChange_Password

The Access Portal Service uses the Common Audit Framework (CAF) for auditing. To enable CAF, set the `UseCAF` property in the `oam-config.xml` file to `true`.

7.7 Validating Run-time Event Logging Configuration

You can use the following procedure to test your run-time event logging configuration.

Before you begin:

- Configure logging using WLST commands
- Ensure the Agents and Servers are running.

- Configure an Application Domain to protect the resource as described in [Managing Policies to Protect Resources and Enable SSO](#).

To validate run-time event logging configuration:

1. In a browser, enter the URL to a protected resource and sign in using an invalid credential.
2. Sign in again using the proper credential.
3. On the physical server, verify all the logs appear in:

```
$DOMAIN_HOME/oamlogs/  
$DOMAIN_HOME/ostslogs/SERVER-NAME-diagnostics.log  
$DOMAIN_HOME/oiflogs/SERVER-NAME-diagnostics.log
```

4. Open the log file and look for the last entries to confirm authentication failure and success, respectively.

Auditing Administrative and Run-time Events

In Oracle Fusion Middleware, auditing refers to the process of collecting review specific information related to administrative, authentication, and run-time events. Auditing can help you evaluate adherence to policies, user access controls, and risk management procedures, and provides a measure of accountability and answers to the "who has done what and when" types of questions.

Audit data can be used to create dashboards, compile historical data, and assess risks. Analyzing recorded audit data allows compliance officers to perform periodic reviews of compliance policies. (Analyzing and using audit data is outside the scope of this chapter.)

The following topics describe the administrative and run-time events that can be audited for Oracle Access Management services as well as information on configuring common auditing settings and validating your auditing configuration:

- [Introduction to Oracle Fusion Middleware Auditing](#)
- [Oracle Access Management Auditing](#)
- [Access Manager Events You Can Audit](#)
- [Mobile and Social Events You Can Audit](#)
- [Identity Federation Events You Can Audit](#)
- [Security Token Service Events You Can Audit](#)
- [Setting Up Auditing for Oracle Access Management](#)
- [Validating Auditing and Reports](#)

8.1 Introduction to Oracle Fusion Middleware Auditing

Review the following topics in the *Securing Applications with Oracle Platform Security Services* to gain an understanding of auditing and the Audit Framework in Oracle Fusion Middleware:

- Introduction to Oracle Fusion Middleware Audit Framework
- Setting up Oracle Business Intelligence Publisher
- Customizing Audit Reports
- ["Auditing the Security Token Service "](#)
- Oracle Fusion Middleware Audit Framework Reference for details about how the Audit database is laid out

Note:

There is nothing specific or separate related to auditing OpenSSO Agents or Identity Context. Unless explicitly stated, information is the same for all Oracle Access Management services.

8.2 Oracle Access Management Auditing

Many businesses must now be able to audit identity information and user access on applications and devices.

Compliance audits help an enterprise conform with regulatory requirements—Sarbanes-Oxley or the Health Insurance Portability and Accountability Act (HIPAA) are two examples.

The following topics provide information about:

- [Understanding Oracle Access Management Auditing](#)
- [About Oracle Access Management Auditing Configuration](#)
- [About Audit Record Storage](#)
- [About Audit Reports and Oracle Business Intelligence Publisher](#)
- [Oracle BI Enterprise Edition \(Oracle BI EE\)](#)
- [About the Audit Log and Data](#)

8.2.1 Understanding Oracle Access Management Auditing

Oracle Access Management uses the Oracle Fusion Middleware Common Audit Framework to support auditing for a large number of user authentication and authorization run-time events, and administrative events (changes to the system). The Oracle Fusion Middleware Common Audit Framework provides uniform logging and exception handling and diagnostics for all audit events.

Auditing is based on configuration parameters set using the Oracle Access Management Console which enables data capture for a user or set of users. While auditing can be enabled or disabled, it is normally enabled in production environments. Audit data can be written to either a single, centralized Oracle Database instance or to flat files known as bus-stop files.

Note:

The Oracle Fusion Middleware Common Audit Framework database audit store does not include Access Manager policy or session-data and is not configured through the Oracle Access Management Console.

Auditing has minimal performance impact, and the information captured by auditing can be useful (even mission-critical). The audit log file helps the audit Administrator track errors and diagnose problems if the audit framework is not working properly.

8.2.2 About Oracle Access Management Auditing Configuration

An Administrator controls certain auditing parameters using the Oracle Access Management Console. This auditing configuration is recorded in the `oam-config.xml` file.

Additional auditing configuration is required through the Common Audit Framework.

Note:

Oracle recommends that you use only the Oracle Access Management Console or WebLogic Scripting Tool (WLST) commands for changes; do not edit the `oam-config.xml` file directly.

Event configuration (mapping events to levels) occurs in the `component_events.xml` file. An audit record contains a sequence of items that can be configured to meet particular requirements.

Within the Oracle Access Management Console, you can set the maximum log file and log directory size. Audit policies (known as Filter Presets) declare the types of events to be captured by the audit framework for particular components.

Audit policies cannot be configured using Fusion Middleware Control. Oracle Access Management does not use JPS infrastructure to configure the audit configuration. There are no WebLogic Scripting Tool (WLST) commands for auditing.

See Also:

- [Access Manager Events You Can Audit.](#)
 - [Security Token Service Events You Can Audit](#)
-
-

8.2.3 About Audit Record Storage

Audit data can be written to either a single, centralized Oracle Database instance or to flat files known as *bus-stop* files. By default, audit data is recorded to the file but administrators can change the configuration to log audit data to a database. Although the formats differ, audit data content is identical in both the flat file and the database.

- **Audit Bus-stop:** Local files containing audit data records before they are pushed to the audit data store. In the event that no audit data store is configured, audit data remains in these bus-stop files. The bus-stop files are simple text files that can be queried easily to look up specific audit events. When an audit data store is in place, the bus-stop acts as an intermediary between the component and the audit data store. The local files are periodically uploaded to the audit data store based on a configurable time interval.

Bus-stop files for Java components are located in:

```
$DOMAIN_HOME/servers/$SERVER_NAME/logs/auditlogs/OAM/audit.log
```

Bus-stop files for system components are located in:

`$ORACLE_INSTANCE/auditlogs/OAM/oam_server1/audit.log`

- **Database Logging:** Implements the Common Auditing Framework across a range of Oracle Fusion Middleware products. The benefit is audit-function commonality at the platform level.
- **Database Audit Store:** In production environments, Oracle recommends using a database audit store to provide scalability and high-availability for the Common Audit Framework. A key advantage of the audit data store is that audit data from multiple components can be correlated and combined in reports; for example, authentication failures in all Middleware components and instances. Audit data is cumulative and grows over time so ideally this is a stand-alone RDBMS database for audit data only and not used by other applications.

Note:

The preferred mode in production environments is writing audit records to a stand-alone RDBMS database for audit data only.

To switch to a database as the permanent store for your audit records, you must first use the Repository Creation Utility (RCU) to create a database schema for audit data. The RCU seeds that database store with the schema required to store audit records in a database. After the schema is created, configuring a database audit store involves:

- Creating a data source that points to the audit schema you created
- Configuring the audit store to point to the data source

As previously documented, the Oracle Fusion Middleware Audit Framework schema is provided by the RCU.

[Figure 8-1](#) provides a simplified view of the audit architecture with a supported database.

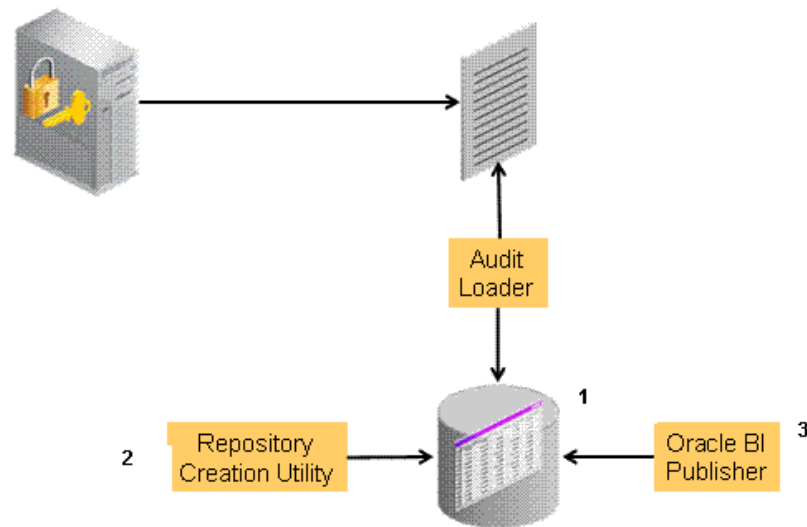
Figure 8-1 Audit to Database Architecture**See Also:**

- See "Configuring and Managing Auditing" in the *Securing Applications with Oracle Platform Security Services*
- See [Setting Up the Audit Database Store](#).

An independent audit loader process reads the flat log file and inserts records in the log table of the Oracle database. The audit store allows Administrators to expose audit data with Oracle Business Intelligence Publisher using a variety of out-of-the-box reports.

8.2.4 About Audit Reports and Oracle Business Intelligence Publisher

Oracle Access Management integrates with Oracle Business Intelligence Publisher, which provides a pre-defined set of compliance reports through which the data in the database audit store is exposed. These reports allow you to drill down the audit data based on various criteria, such as user name, time range, application type, and execution context identifier (ECID).

Out-of-the-box, there are several sample audit reports available with Oracle Access Management and accessible with Oracle Business Intelligence Publisher. You can also use Oracle Business Intelligence Publisher to create your own custom audit reports.

8.2.5 Oracle BI Enterprise Edition (Oracle BI EE)

Oracle BI Enterprise Edition (Oracle BI EE) is a comprehensive set of enterprise business intelligence tools and infrastructure, including a scalable and efficient query and analysis server, an ad-hoc query and analysis tool, interactive dashboards, proactive intelligence and alerts, real-time predictive intelligence, and an enterprise reporting engine.

The components of Oracle BI EE share a common service-oriented architecture, data access services, analytic and calculation infrastructure, metadata management services, semantic business model, security model and user preferences, and administration tools. Oracle BI EE provides scalability and performance with data-source specific optimized analysis generation, optimized data access, advanced calculation, intelligent caching services, and clustering.

See Also:

"Using Audit Analysis and Reporting" in the *Securing Applications with Oracle Platform Security Services*

You may need to prepare Oracle BI EE for use with auditing reports for Oracle Access Management.

See [Preparing Oracle Business Intelligence Publisher EE](#).

Oracle BI EE reports contain enumerated fields, the data fields and labels of which are self-explanatory. Content of reports is described in [Table 8-1](#) (taken from Knowledge Base Doc ID 1495333.1 on My Oracle Support).

Table 8-1 Oracle Business Intelligence Enterprise Edition Reports for OAM

Report Type	Description
Account Management	User ID Timestamp Component/ Application Name Event Details
Authentication_Statistics	Authentication_statistics Failure Userid Number of Events AuthenticationFromIPByUser IP Address Distinct User Count Total Attempts Users AuthenticationPerIP IP Address Distinct Users Total Number of Attempts AuthenticationStatisticsPerServer Server Instance Name Success Count Failure Count
Errors_and_Exceptions	All_Errors_and_Exceptions User ID Timestamp Component/ Application Name Client IP Address Message Event Event Details Authentication_Failures User ID Timestamp Component/ Application Name Client IP Address Authentication Method Message Event Details Authorization_Failures Users_Activities Authentication_History User ID Timestamp Component/ Application Name Client IP Address Authentication Method Message Event Details Authorization_Failures Multiple_Logins_From_Same_IP IP Address Usernames Used

See the following topics:

- [Access Manager Events You Can Audit](#)
- [Identity Federation Events You Can Audit](#)
- [Security Token Service Events You Can Audit](#)

8.2.6 About the Audit Log and Data

An audit log file helps the audit administrator track errors and diagnose problems when the audit framework is not working properly. An audit log file records several fields including (but not limited to) Date, Time, Initiator, EventType, EventStatus, MessageText, ECID, RID ContextFields, SessionId, TargetComponentType, ApplicationName, and EventCategory.

See Also:

The topic on audit logs when configuring and managing auditing in the *Securing Applications with Oracle Platform Security Services*.

8.3 Access Manager Events You Can Audit

Oracle Access Management uses the Oracle Fusion Middleware Common Audit Framework to support auditing for a large number of user authentication and authorization run-time events, and administrative events.

The following topics describe how to audit Access Manager events:

- [Access Manager Administrative Events You Can Audit](#)
- [Access Manager Run-time Events You Can Audit](#)
- [Auditing Authentication Events](#)

See Also:

- [Identity Federation Events You Can Audit](#)
 - [Security Token Service Events You Can Audit](#)
-
-

8.3.1 Access Manager Administrative Events You Can Audit

Administrative events are those generated when the Oracle Access Management Console is used.

The Access Manager-specific administrative events that can be audited and the details captured for them are listed in [Table 8-2](#). These event definitions and configurations are implemented as part of the audit service in Oracle Platform Security Services.

Note:

The amount and type of information that is logged is controlled by choosing a filter preset from the Audit Configuration section. Auditable events for each filter preset are fixed in the read-only `component_events.xml` file. Editing or customizing this file is not supported.

Table 8-3 lists the details that have been captured.

Table 8-2 Access Manager Administrative Audit Events

Administrative Event	Event Data Include
Oracle Access Management Console Login success/failure	<ul style="list-style-type: none"> • User name • Remote IP • Roles
Authentication Policy Creation	<ul style="list-style-type: none"> • Policy name • Authentication scheme details • Resource details • Policy type (authentication or authorization)
Authentication Policy Modification	<ul style="list-style-type: none"> • Policy name • Authentication scheme details • Resource details • Policy type (authentication or authorization) • Old Policy name • Old Authentication scheme details • Old Resource details
Authentication Policy Removal	<ul style="list-style-type: none"> • Policy name • Authentication scheme details • Resource details • Policy type (authentication or authorization)
Resource Creation	<ul style="list-style-type: none"> • Resource name • URI • Operation • Resource type
Resource Modification	<ul style="list-style-type: none"> • Resource name • URI • Operation • Resource type • Old Resource name • Old URI • Old Operation
Resource Removal	<ul style="list-style-type: none"> • Resource name • URI • Operation • Resource type
Authentication Scheme Creation	<ul style="list-style-type: none"> • Scheme name • Authentication modules • Level

Table 8-2 (Cont.) Access Manager Administrative Audit Events

Administrative Event	Event Data Include
Authentication Scheme Modification	<ul style="list-style-type: none"> • Scheme name • Authentication modules • Level • Old Scheme name • Old Authentication modules • Old Level
Authentication Scheme Removal (Delete)	<ul style="list-style-type: none"> • Scheme name • Authentication modules • Level
Response Creation	<ul style="list-style-type: none"> • Response name • Response key • Data source • Response Type
Response Modification	<ul style="list-style-type: none"> • Response name • Response key • Data source • Response Type • Old Response name • Old Response key • Old Data source
Response Removal (Delete)	<ul style="list-style-type: none"> • Response name • Response key • Data source • Response Type
Partner Addition	<ul style="list-style-type: none"> • Partner name • Partner ID • Partner URL • Logout URL
Partner Modification	<ul style="list-style-type: none"> • Partner name • Partner ID • Partner URL • Logout URL • Old Partner name • Old Partner URL • Old Logout URL
Partner Removal	<ul style="list-style-type: none"> • Partner name • Partner ID • Partner URL • Logout URL
Conditions creation	<ul style="list-style-type: none"> • Condition Name • Condition type • Condition data

Table 8-2 (Cont.) Access Manager Administrative Audit Events

Administrative Event	Event Data Include
Conditions Modification	<ul style="list-style-type: none"> Condition Name Condition type Condition data Old Condition name Old Condition type Old Condition data
Conditions Removal	<ul style="list-style-type: none"> Condition Name Condition type Condition data
Server Domain creation	<ul style="list-style-type: none"> Domain Name
Server Domain Modification	<ul style="list-style-type: none"> Domain Name Old Domain Name
Server Domain Removal	<ul style="list-style-type: none"> Domain Name
Server configuration change	<ul style="list-style-type: none"> New details Old details Instance Name Application Name User Name Remote ID Roles Date and time

8.3.2 Access Manager Run-time Events You Can Audit

Run-time events are those generated by some of the events the Access Manager component engines issue when interacting with one another. The run-time events that can be audited, when they are issued. These event definitions and configurations are implemented as part of the audit service in Oracle Platform Security Services.

Note:

The amount and type of information that is logged is controlled by choosing a filter preset in the Audit Configuration. Auditable events for each filter preset are fixed in the read-only `component_events.xml` file. Editing or customizing this file is not supported.

Table 8-3 Access Manager Run-time Audit Events

Run-time Event	Issued When	Event Details Include
Authentication Attempt	A user attempts to access a protected resource and the request arrives at the SSO server; this event might be followed by the events credential submit and authentication success or failure.	<ul style="list-style-type: none"> Remote IP Resource ID Partner ID Resource ID Authentication scheme ID Authentication Policy ID

Table 8-3 (Cont.) Access Manager Run-time Audit Events

Run-time Event	Issued When	Event Details Include
Authentication Success	A client submits credentials and credential validation is successful.	<ul style="list-style-type: none"> • Remote IP • User Name • User DN • Resource ID • Authentication scheme ID • Authentication Policy ID • Partner ID
Authentication Failure	A client submits credentials and credential validation fails.	<ul style="list-style-type: none"> • Remote IP • User Name • User DN • Resource ID • Authentication Scheme ID • Failure Error Code • Retry count • Authentication Policy ID • Partner ID
Session Creation	Authentication succeeds.	<ul style="list-style-type: none"> • SSO Session ID • User Name • User DN • Remote IP • Resource ID • Authentication scheme ID • Authentication Policy ID
Session Destroy	Authentication succeeds.	<ul style="list-style-type: none"> • SSO Session ID • User Name • User DN • Partner ID
Login success	A client finishes the login procedure and it is forwarded to the agent.	<ul style="list-style-type: none"> • Remote IP • User Name • User DN • Authentication level • Resource ID • Authentication scheme ID • Authentication Policy ID • Partner ID
Login failure	A client fails to login; this event is issued only when all the retry authentication attempts allowed have failed or when the account is locked.	<ul style="list-style-type: none"> • Remote IP • User Name • Authentication level • Resource ID • Authentication scheme ID • Authentication Policy ID • Partner ID

Table 8-3 (Cont.) Access Manager Run-time Audit Events

Run-time Event	Issued When	Event Details Include
Logout success	A client finishes the logout procedure and is forwarded to the agent.	<ul style="list-style-type: none"> Remote IP User DN Authentication level SSO Session ID Partner ID
Logout failure	A client fails to logout.	<ul style="list-style-type: none"> Remote IP User DN SSO Session ID Failure details Partner ID
Credential Collection	A client is redirected to the credential collection page.	<ul style="list-style-type: none"> Remote IP Resource Name Resource ID Authentication scheme ID Authentication Policy ID
Credential Submit	A client submits credentials.	<ul style="list-style-type: none"> Remote IP User Name Resource ID Authentication scheme ID Authentication Policy ID
Authorization Success	A client has been authorized to access a resource.	<ul style="list-style-type: none"> Remote IP User DN Resource ID Authorization Policy ID
Authorization Failure	A client has not been authorized to access a resource.	<ul style="list-style-type: none"> Remote IP User DN Resource ID Authorization Policy ID
Server Start Up	The server starts up.	<ul style="list-style-type: none"> Date and time Instance Name Application Name User Name
Server Shut Down	The server shuts down.	<ul style="list-style-type: none"> Date and time Instance Name Application Name User Name

8.3.3 Auditing Authentication Events

Auditing events during authentication can help Administrators scrutinize security weaknesses in their systems.

The events that an Administrator can configure for auditing during authentication are:

- Authentication success

- Authentication failure
- Create, modify, delete, or view Authentication Policy data

Information related to the user being authenticated may include the following:

- IP address
- Browser type
- User Login ID
- Time of Access

Note:

Oracle recommends that you avoid auditing, logging, or tracing sensitive user attributes, such as user passwords.

Information about users requesting authentication or brute force attacks can be stored in the file system or in a back-end database.

8.3.4 Auditing Events for Delegated Administrators

Auditing of policy object and system configuration operations performed by delegated administrators are captured under **GenericAdminOperation** audit event. The audit data that is captured in the audit log are as listed below:

- Granted Role Name
- Revoked Role Name
- Granted to Identity Name
- Revoked from Identity Name
- Application Domain Name
- Date and time
- IP
- User Name
- Application Name
- Server Name

Following examples illustrate the audit log for admin delegated events:

Example 8-1 Audit log for privileged user granting a role to an identity

```
Audit log snippet- 2016-04-11 08:02:43.189 "weblogic" "GenericAdminOperation" true
"Role:'Application Administrator' Granted to:'admin1'" "weblogic"-
"Application Administrator"---...
```

Example 8-2 Audit log for privileged user revoking a role from an identity

```
Audit log snippet- 2016-04-11 08:03:27.040 "weblogic" "GenericAdminOperation" true
"Role:'Application Administrator' Revoked From:'admin1'" "weblogic"-
"Application Administrator"---...
```

Example 8-3 Audit log for privileged user granting a role to an identity within an Application Domain

```
Audit log snippet- 2016-04-11 08:08:32.487 "weblogic" "GenericAdminOperation" true
"Role:'Application Domain Administrator' Granted to:'admin1'
AppDomain:'appdomain'" "weblogic"-...
```

Example 8-4 Audit log for privileged user revoking a role from an identity within an Application Domain

```
Audit log snippet- 2016-04-11 08:09:03.099 "weblogic" "GenericAdminOperation" true
"Role:'Application Domain Administrator' Revoked From:'admin1'
AppDomain:'appdomain'" "weblogic" - "Application Domain Administrator"--
"appdomain" "oam_admin(11.1.2.3)"...
```

8.4 Mobile and Social Events You Can Audit

The following topics describe how to audit mobile and social events:

- [REST Run-Time Audit Events](#)
- [Mobile and Social Audit Events](#)

8.4.1 REST Run-Time Audit Events

You can audit the REST run-time events.

Table 8-4 REST Run-Time Audit Events

Run-time Event	Issued When	Event Details Include
Partner Security Validation Event	Partner credentials are validated using the appropriate security mechanism. The event is logged for both success and failure scenarios.	<ul style="list-style-type: none"> • Partner ID (or any unique partner var) • Remote IP • Security Mechanism • Service Instance (Endpoint or name) • Event Status (success/fail)
Create Token	A token is created.	<ul style="list-style-type: none"> • Event Status • Caller Attribute • Subject Attribute • Filter Subject Attribute • Token Attribute • Opcode Attribute • Message Text

Table 8-4 (Cont.) REST Run-Time Audit Events

Run-time Event	Issued When	Event Details Include
Terminate Token	A token is terminated.	<ul style="list-style-type: none"> • Event Status • Caller Attribute • Subject Attribute • Filter Subject Attribute • Token Attribute • Opcode Attribute • Message Text
Get Token	A token is obtained/read.	<ul style="list-style-type: none"> • Event Status • Caller Attribute • Subject Attribute • Filter Subject Attribute • Token Attribute • Opcode Attribute • Message Text

8.4.2 Mobile and Social Audit Events

You can audit the Mobile and Social runtime events.

Table 8-5 Mobile and Social Run-Time Audit Events

Run-Time Event	Issued When	Event Details Include
IDP Login	A user attempts to log in using an identity provider	<ul style="list-style-type: none"> • Event status • Application ID • Identity provider name • Event message
IDP Rest Access	The REST service for identity providers is accessed	<ul style="list-style-type: none"> • Event status • Application ID • Protocol • Event message
IDP User Profile	The user profile related to a user authenticated by an identity provider is obtained	<ul style="list-style-type: none"> • Event status • Application ID • User attributes • Identity provider name • Event message (optional attributes)
Local Registration	A user registers locally by providing registration info	<ul style="list-style-type: none"> • Event status • User ID • First name • Last name • E-mail • Location • Time zone • Event message

Table 8-5 (Cont.) Mobile and Social Run-Time Audit Events

Run-Time Event	Issued When	Event Details Include
Security Validation	The security mechanism on the Identity Provider REST Services for Relying Party (RP) is validated	<ul style="list-style-type: none"> • Security mechanism • Client principal • Remote IP address • Event message
OpenID Authentication Request	An OpenID authentication request is initiated	<ul style="list-style-type: none"> • Event status • Request ID • IDP login URL • Request attributes • Message text
OAuth Authentication Request	An OAuth authentication request is initiated	<ul style="list-style-type: none"> • Event status • Request ID • Return URL • IDP attributes • Message text
OAuth Access Token Request	An OAuth access token request is initiated	<ul style="list-style-type: none"> • Event status • Request ID • Token • Message text
Local Login	User logs in locally	<ul style="list-style-type: none"> • Event status • Application ID • User ID • Token • Message text

8.5 Identity Federation Events You Can Audit

The Identity Federation service also uses the Fusion Middleware Audit Framework for auditing.

The following data is part of each audit record, regardless of the event or event type that is audited:

- timestamp - Date and time the audit event occurred
- initiator - the initiator of the audit event (for some events this attribute may be empty)
- ECID - the execution context ID

The Fusion Middleware Audit Framework supports the following audit levels:

- None
- Low
- Medium
- Custom

Events can be audited in different categories and audit levels.

Table 8-6 lists the event categories.

Table 8-6 Categories of Audit Events for Identity Federation

Category	Described in ...
Session Management	Session Management Events for Identity Federation
Protocol Flow	Protocol Flow Events for Identity Federation
Server Configuration	Server Configuration Events for Identity Federation
Security	Security Events for Identity Federation

See Also:

chapter on "Diagnostics and Auditing" for greater detail

The following section contain more information.

- [Session Management Events for Identity Federation](#)
- [Protocol Flow Events for Identity Federation](#)
- [Server Configuration Events for Identity Federation](#)
- [Security Events for Identity Federation](#)

8.5.1 Session Management Events for Identity Federation

Session Management events for this Identity Federation release, include a subset of auditable events for the previous release.

For attributes of each event, see "Session Management Events" in .

Table 8-7 Identity Federation Session Management Events

Auditable Events	Auditing Not Supported in This Release for ...
CreateUserSession – Creation of a session after a successful login	CreateUserFederation – Creation of a user federation between two remote servers
DeleteUserSession – Deletion of a session after logout	UpdateUserFederation – Updating the user federation between two remote servers
CreateActiveUserFederation – Creation of an active federation after successful login	DeleteUserFederation – Deletion of a user federation between two remote servers
CreateActiveUserFederation – Creation of an active federation after successful login	

Table 8-7 (Cont.) Identity Federation Session Management Events

Auditable Events	Auditing Not Supported in This Release for ...
DeleteActiveUserFederation - Deletion of an active federation after logout	
LocalAuthentication – Authentication of a user at OIF	
LocalLogout - Logout of a user at Identity Federation	

8.5.2 Protocol Flow Events for Identity Federation

Protocol flow events for this Identity Federation release, include a subset of auditable events for the previous Identity Federation release.

For attributes of each event, see "Protocol Flow Events" in .

Table 8-8 Protocol Flow Events for Identity Federation

Auditable Events	Auditing Not Supported in This Release for ...
IncomingMessage Message being received by Identity Federation	AssertionCreation Creation of an assertion by Identity Federation (Success only)
OutgoingMessage Message being sent by Identity Federation (Success only)	
AssertionConsumption Consumption of an assertion by Identity Federation (Success only)	

8.5.3 Server Configuration Events for Identity Federation

Auditable Server configuration events for this Identity Federation release, include a subset of auditable events for the previous Identity Federation release.

For attributes of each event, see "Server Configuration Events" in .

Table 8-9 Server Configuration Identity Federation

Auditable Events	Auditing Not Supported in This Release for ...
CreateConfigProperty Adding a new configuration property (Success only)	SetDataStoreType Changing the type of a data store (Success only)

Table 8-9 (Cont.) Server Configuration Identity Federation

Auditable Events	Auditing Not Supported in This Release for ...
ChangeConfigProperty Changing the value of an existing configuration property (Success only)	ChangeDataStore Setting of the federation data store (Success only)
DeleteConfigProperty Deleting a configuration property (Success only)	
CreatePeerProvider Adding a new provider to the list of trusted providers (Success only)	
UpdatePeerProvider Updating the information on an existing provider in the list of trusted providers (Success only) PeerProviderID	
DeletePeerProvider Deleting a provider from the list of trusted providers (Success only)	
LoadMetadata Loading of metadata (Success only)	
ChangeFederation Changing of the trusted providers (Success only)	
ChangeServerProperty Changing of a server configuration property (Success only)	

8.5.4 Security Events for Identity Federation

Auditable security events for this Identity Federation release, include all auditable events for the previous Identity Federation release.

For attributes of each event, see "Security Events" in .

Table 8-10 Security Events for Identity Federation

Auditable Events	Auditing Not Supported in This Release for ...
CreateSignature Creation of a digital signature by Identity Federation	n/a
VerifySignature Verification of a digital signature by Identity Federation	

Table 8-10 (Cont.) Security Events for Identity Federation

Auditable Events	Auditing Not Supported in This Release for ...
EncryptData Encryption of data by Identity Federation	
DecryptData Decryption of data by Identity Federation	

8.6 Security Token Service Events You Can Audit

Security Token Service provides an independent audit configuration file, named `component_events.xml`, that defines specific event types and events to audit.

The following sections provide more details.

- [About Audit Record Content Common to All Events](#)
- [Security Token Service Administrative Events You Can Audit](#)
- [Security Token Service Run-time Events You Can Audit](#)

8.6.1 About Audit Record Content Common to All Events

Regardless of the event or event type that is audited, some of the audit record content is Common to All Events.

The following data is part of each audit record::

- Date and time of event
- IP address of the client initiating event
- Client identity
- Processing time for the event

8.6.2 Security Token Service Administrative Events You Can Audit

Security Token Service administrative events fall into several configuration management operations defined in `component_events.xml`.

[Table 8-11](#) lists additional information.

See Also:

[Setting Up Auditing for Oracle Access Management](#)

Table 8-11 Security Token Service Configuration Management Operations

Security Token Service Configuration Operations	Description
Common Attributes	<ul style="list-style-type: none"> • OldSettings: The string representing the previous settings before the change was applied. • NewSettings: The string representing the new settings. • TemplateID: The ID of the Validation or Issuance Template being created or updated or deleted. • ProfileID: The ID of the Partner Profile being created or updated or deleted. • PartnerID: The ID of the Partner being created or updated or deleted. • SettingsID: The ID of the generic settings being created or updated or deleted.
Create Validation Template	<p>Audit event recorded for the creation of a Validation Template referenced by CreateValidationTemplate.</p> <p>Attributes:</p> <ul style="list-style-type: none"> • TemplateID • NewSettings
Update Validation Template	<p>Audit event recorded for the update of a Validation Template referenced by UpdateValidationTemplate.</p> <p>Attributes:</p> <ul style="list-style-type: none"> • TemplateID • OldSettings • NewSettings
Delete Validation Template	<p>Audit event recorded for the delete event of a Validation Template referenced by DeleteValidationTemplate.</p> <p>Attributes:</p> <ul style="list-style-type: none"> • TemplateID • OldSettings
Create Issuance Template	<p>Audit event recorded for the creation of an Issuance Template referenced by CreateIssuanceTemplate.</p> <p>Attributes:</p> <ul style="list-style-type: none"> • TemplateID • NewSettings
Update Issuance Template	<p>Audit event recorded for the update of an Issuance Template referenced by UpdateIssuanceTemplate.</p> <p>Attributes:</p> <ul style="list-style-type: none"> • TemplateID • OldSettings • NewSettings
Delete Issuance Template	<p>Audit event recorded for the delete event of an Issuance Template referenced by DeleteIssuanceTemplate.</p> <p>Attributes:</p> <ul style="list-style-type: none"> • TemplateID • OldSettings

Table 8-11 (Cont.) Security Token Service Configuration Management Operations

Security Token Service Configuration Operations	Description
Create Partner Profile	Audit event recorded for the creation of Partner Profile referenced by CreatePartnerProfile. Attributes: <ul style="list-style-type: none"> • ProfileID • NewSettings
Update Partner Profile	Audit event recorded for the update of a Partner Profile referenced by UpdatePartnerProfile. Attributes: <ul style="list-style-type: none"> • ProfileID • OldSettings • NewSettings
Delete Partner Profile	Audit event recorded for the delete event of Partner Profile referenced by DeletePartnerProfile. Attributes: <ul style="list-style-type: none"> • ProfileID • OldSettings
Create Partner	Audit event recorded for the creation of Partner Profile referenced by CreatePartner. Attributes: <ul style="list-style-type: none"> • PartnerID • NewSettings
Update Partner	Audit event recorded for the update of a Partner Profile referenced by UpdatePartner. Attributes: <ul style="list-style-type: none"> • PartnerID • OldSettings • NewSettings
Delete Partner	Audit event recorded for the delete event of Partner Profile referenced by DeletePartner. Attributes: <ul style="list-style-type: none"> • PartnerID • OldSettings
Generic Admin Creation	Audit event recorded for the generic create administrative operation referenced by GenericAdminCreation. Attributes: <ul style="list-style-type: none"> • SettingsID • NewSettings

Table 8-11 (Cont.) Security Token Service Configuration Management Operations

Security Token Service Configuration Operations	Description
Generic Admin Update	Audit event recorded for the update of a generic update administrative operation referenced by GenericAdminUpdate. Attributes: <ul style="list-style-type: none"> SettingsID OldSettings NewSettings
Generic Admin Removal	Audit event recorded for generic delete administrative operation referenced by GenericAdminDeletion. Attributes: <ul style="list-style-type: none"> SettingsID OldSettings

8.6.3 Security Token Service Run-time Events You Can Audit

Security Token Service-specific run-time events for token operations are defined in `component_events.xml`.

See details in [Table 8-12](#).

Table 8-12 Security Token Service-specific Run-time Events

Token Operations	Description
Common Attributes	<ul style="list-style-type: none"> Requester: Who made the request by sending the RST RelyingParty: The one for whom the token is created UserID: End user identity TokenType: Either SAML11, SAML20, Username, X.509, Kerberos, OAM or Custom Token: The XML value of the token TokenContext: The Context data passed for token operations Message: The XML representation of the incoming or outgoing message
Incoming Message	Incoming RSTR message received by Security Token Service referenced by OutgoingMessage. Attributes populated for this event, if available: <ul style="list-style-type: none"> Requester RelyingParty Message

Table 8-12 (Cont.) Security Token Service-specific Run-time Events

Token Operations	Description
Outgoing Message	<p>Outgoing RSTR message received by Security Token Service referenced by IncomingMessage.</p> <p>Attributes populated for this event, if available:</p> <ul style="list-style-type: none"> • Requester • RelyingParty • Message
Token Validation	<p>Audit event for token validation in Security Token Service referenced by TokenValidation. The status attribute indicates whether or not the validation operation was successful.</p> <p>Attributes populated for this event, if available:</p> <ul style="list-style-type: none"> • Requester • RelyingParty • Token • TokenType • TokenContext • Status
Token Generation	<p>Audit event for token generation in Security Token Service referenced by TokenGeneration.</p> <p>Attributes populated for this event, if available:</p> <ul style="list-style-type: none"> • Requester • RelyingParty • Token • TokenType • TokenContext • UserID
LDAP User Authentication	<p>Audit event for local user authentication with the LDAP Directory referenced by LDAPUserAuthentication.</p> <p>Attributes populated for this event, if available:</p> <ul style="list-style-type: none"> • UserID • Status
Generic Runtime Operation	<p>Audit event for a generic operation performed by Security Token Service referenced by GenericRuntimeOperation</p> <p>Attributes populated for this event, if available:</p> <ul style="list-style-type: none"> • OperationType: type of operation • OperationData: string representing context of the operation

8.7 Setting Up Auditing for Oracle Access Management

Before you perform auditing for Oracle Access Management, ensure to set up the audit data store and set up publishing for audit reports.

The following overview provides a list of the tasks that must be performed before auditing:

1. Set up the audit data store.
See [Setting Up the Audit Database Store](#).
2. Set up publishing for audit reports.
See [Preparing Oracle Business Intelligence Publisher EE](#).
3. Edit the Audit Configuration in the Oracle Access Management Console, as described in:
 - [Using the Oracle Access Management Console for Audit Configuration](#)
 - [Adding, Viewing, or Editing Audit Settings](#)

See [Validating Auditing and Reports](#) for details on how to test and validate the audit configuration.

8.7.1 Setting Up the Audit Database Store

Here is an overview of the tasks required to create the audit database and extend the schema using the Repository Creation Utility (RCU).

This task is required before you can audit events for Oracle Access Management if you choose a database store for audit data.

See Also:

- *Securing Applications with Oracle Platform Security Services* for details on managing the audit store
 - Oracle Fusion Middleware Repository Creation Utility User's Guide
-
-

To create an audit database store:

1. Create an audit database, version 11.1.0.7 or later.
See the *Securing Applications with Oracle Platform Security Services*.
2. Run the RCU against the database.
See "Create the Audit Schema using RCU" in the Oracle Fusion Middleware Repository Creation Utility User's Guide.
3. Set up audit data sources for the audit loader and configure it for the OAM Server.
See "Set Up Audit Data Sources" in the *Securing Applications with Oracle Platform Security Services*:
 - Use the Java EE audit loader configuration for WebLogic Server.
 - Use the JNDI name of the data source jdbc/AuditDB that points to the database that was set up in step 2 above.
4. In the service instance specified in the domain file (`$DOMAIN_HOME/config/fmwconfig/jps-config.xml`), enable database auditing by changing the value of the property `audit.loader.repositoryType` to `DB`. For example:

```
<serviceInstance name="audit.db" provider="audit.provider">
  <property name="audit.loader.repositoryType" value="DB"/>
  <property name="auditstore.type" value="db"/>
  <property name="audit.loader.jndi" value="jdbc/AuditDB"/>
  <property name="audit.maxDirSize" value="0"/>
  <property name="audit.filterPreset" value="None"/>
  <property name="audit.maxFileSize" value="104857600"/>
  <property name="audit.loader.interval" value="15"/>
  <propertySetRef ref="props.db.1"/>
</serviceInstance>
```

5. Restart the WebLogic Server.
6. Ensure that the audit loader is configured for the OAM Server and that it points to the proper database, as described in "Configure a Database Audit Store for Java Components" in the *Securing Applications with Oracle Platform Security Services*.
7. Maintain the bus-stop files, as described in "Tuning the Bus-stop Files" in the *Securing Applications with Oracle Platform Security Services*.

8.7.2 Preparing Oracle Business Intelligence Publisher EE

You must prepare Oracle Business Intelligence Publisher Enterprise Edition (EE) for use with Oracle Access Management audit reports.

Here is an outline of the procedure to prepare Oracle Business Intelligence Publisher EE.

See Also:

- *Oracle Fusion Middleware Metadata Repository Builder's Guide for Oracle Business Intelligence Enterprise Edition*
 - *Oracle Fusion Middleware Developer's Guide for Oracle Business Intelligence Enterprise Edition*
 - *Securing Applications with Oracle Platform Security Services*
-
-

To prepare Oracle Business Intelligence Publisher:

1. Install Oracle BI Publisher.

See the *Oracle Business Intelligence Enterprise Edition Installation and Upgrade Guide*.

2. Perform the following tasks:

See "Set Up Oracle Reports in Oracle Business Intelligence Publisher" in the *Securing Applications with Oracle Platform Security Services*:

- Unzip the `oam_audit_reports_11.1.2.0.0.zip` into your Reports folder.
This zip file is located in the `$ORACLE_HOME/oam/server/reports/` directory.
- Unjar the `AuditReportTemplates.jar` into your Reports folder.
`AuditReportTemplates.jar` is located in the `$MW_ORA_HOME/oracle_common/modules/oracle.iau_11.1.1/reports/` directory.

- Set up the JNDI connection for the audit data source or the JDBC connection the audit database.

The datasource name must be "Audit".

3. Set up audit report templates, as described in the section "Set Up Audit Report Templates" of the *Securing Applications with Oracle Platform Security Services*.
4. Set up audit report filters, as described in the section "Set Up Audit Report Filters" of the *Securing Applications with Oracle Platform Security Services*.
5. View reports from the following path: Reports/Oracle_Fusion_Middleware_Audit reports.

See Also:

[Validating Auditing and Reports](#)

8.7.3 Using the Oracle Access Management Console for Audit Configuration

Within Oracle Access Management, certain Audit Configuration settings are accessible as Common Settings under the System Configuration. These settings are not required when you audit to a database.

Figure 8-2 shows the Audit Configuration section of the Common Settings page.

Figure 8-2 Common Settings: Auditing Configuration

▲ Audit Configuration

* Maximum Directory Size (MB) ^ v

* Maximum File Size (MB) ^ v

Filter Enabled

* Filter Preset ▼

Audit Configuration

View ▼

Users

orcladmin

SSOAdmin

The Auditing section provides settings for the Log Directory, Filter Settings, and Audit Configuration Users.

Note:

The actual log directory cannot be configured using the Oracle Access Management Console. It is the default directory for the Common Audit Framework audit loader. Changing the directory impacts the audit loader and is not supported.

Table 8-13 describes the elements in the Audit Configuration page.

Table 8-13 Audit Configuration Elements

Elements	Description
Maximum Directory Size	<p>The maximum size, in MBs, of the directory that contains audit output files. For example, assuming that the maximum file size is 10, a value of 100 for this parameter implies that the directory allows a maximum of 10 files. Once the maximum directory size is reached, the audit logging stops.</p> <p>For example, a value of 100 specifies a maximum of 10 files if the file size is 10 MB. If the size exceeds this, the creation of audit logs stops.</p> <p>This is configured using the <code>max.DirSize</code> property described in the configuration file <code>jps-config.xml</code>. This property controls the maximum size of a bus-stop directory for Java components as described in the <i>Securing Applications with Oracle Platform Security Services</i>.</p>
Maximum File Size	<p>The maximum size, in MBs, of an audit log file. Once the size of a file reaches the maximum size, a new log file is created. For example, specifying 10 directs file rotation when the file size reaches 10 MB.</p> <p>This is configured using the <code>max.fileSize</code> property described in the configuration file <code>jps-config.xml</code>. This property controls the maximum size of a bus-stop file for Java components as described in the <i>Securing Applications with Oracle Platform Security Services</i>.</p>
Filter Enabled	Check this box to enable event filtering.
Filter Preset	<p>Defines the amount and type of information that is logged when the filter is enabled. The default value is Low.</p> <ul style="list-style-type: none"> All: captures and records all auditable OAM events Low: captures and records a specific set of auditable OAM events Medium: captures and records events covered by the Low setting plus a number of other auditable OAM events None: no OAM events are captured and recorded <p>Events for each filter preset are fixed in the read-only <code>component_events.xml</code> file. Editing or customizing this file is not supported for Oracle Access Management. Only items that are configured for auditing at the specified filter preset can be audited.</p>

Table 8-13 (Cont.) Audit Configuration Elements

Elements	Description
Users	Specifies the list of users whose actions are included only when the filter is enabled. All actions of the special users are audited regardless of the filter preset. Administrators can add, remove or edit special users from this table.

8.7.4 Adding, Viewing, or Editing Audit Settings

The Administrator controls the amount and type of information that is logged by choosing a filter preset from the Audit Configuration tab on the OAM Server Common Properties page.

Note:

Auditable events for each filter preset are fixed in the read-only `component_events.xml` file. Editing or customizing this file is not supported.

The following procedure describes how to add, view, or edit OAM Server Common Audit Configuration settings. Individual audit policies cannot be configured using Fusion Middleware Control. Oracle Access Management does not use JPS infrastructure to configure the audit configuration. There are no WebLogic Scripting Tool (WLST) commands for auditing.

1. In the Oracle Access Management Console, click **Configuration** at the top of the window.
2. In the **Settings** section, select **Common Settings** from the **View** menu.
3. In the Audit Configuration section, enter appropriate details for your environment See [Table 8-13](#):
 - Maximum Log directory size
 - Maximum Log file size
 - Filter Enabled
 - Filter Preset (to define verbosity of audit data)
 - Users to include specific users from the audit by clicking the Add (+) button above the Users table and entering a value in the field.
4. Click Apply to submit the Audit Configuration (or close the page without applying changes).
5. Restart AdminServer and OAM Servers after changes are applied.

8.8 Validating Auditing and Reports

The run-time event auditing configuration can be tested.

Before you begin:

- Configure auditing parameters.
See [Setting Up Auditing for Oracle Access Management](#).
 - Ensure the Agents and Servers are running.
 - Prepare BI EE Publisher.
See [Preparing Oracle Business Intelligence Publisher EE](#).
1. **To validate an Authentication Event:** Audit Console login success/failure as described here or any administrative event.
See [Table 8-2](#).
 - a. Sign out of Oracle Access Management Console.
 - b. Sign in to Oracle Access Management Console with invalid user (not Administrator) credentials.
 - c. Sign in to Oracle Access Management Console using the proper Administrator credentials.
 - d. **Review Log File:** Open the audit.log file and search for the last Administrative event entries:

```
$DOMAIN_HOME/servers/$ADMINSERVER_NAME/logs/auditlogs/OAM/audit.log
```
 - e. **Review Database Log:**
 - i. Perform the following tasks.
See [Setting Up the Audit Database Store](#).
 - ii. Generate an Authentication event as described in Step 1.
 - iii. Connect to the database and connecting to the database and reviews audit events under IAU_BASE table.
 2. **To validate a Runtime Event:** Audit Authorization success/failure as described here or any runtime event that is described as follows:
See [Table 8-3](#).
 - a. In a browser window, enter the URL of a protected resource for which you are not authorized.
 - b. **Review Log File:** Open the audit.log file and search for the last Administrative event entries:

```
$DOMAIN_HOME/servers/$ADMINSERVER_NAME/logs/auditlogs/OAM/audit.log
```
 - c. **Review Database Log:**
 - i. Perform the following tasks.
See [Setting Up the Audit Database Store](#).
 - ii. Generate and Authentication event as described in Step 1.
 - iii. Connect to the database and connecting to the database and reviews audit events under IAU_BASE table.
 3. **To validate Audit Configuration Changes:**

See Also [Adding, Viewing, or Editing Audit Settings](#) .

- a. From the Oracle Access Management Console, System Configuration tab, Common Configuration, modify Maximum Directory Size (MB) and Maximum File Size (MB) parameters.
 - b. Repeat Steps here to confirm auditing is working.
- 4. To View Reports:**
- a. Sign in to Oracle BI EE. For example:
<http://host:port/xmlpserver>
 Here, *host* is the computer hosting Oracle BI Publisher; *port* is the listening port for BI Publisher; *xmlpserver* is the login page for BI Publisher.
 - b. In Oracle BI Publisher Enterprise, locate the desired reports. For example:
 Click Shared Folders, the component that contains the report you would like to view and then select the desired report.

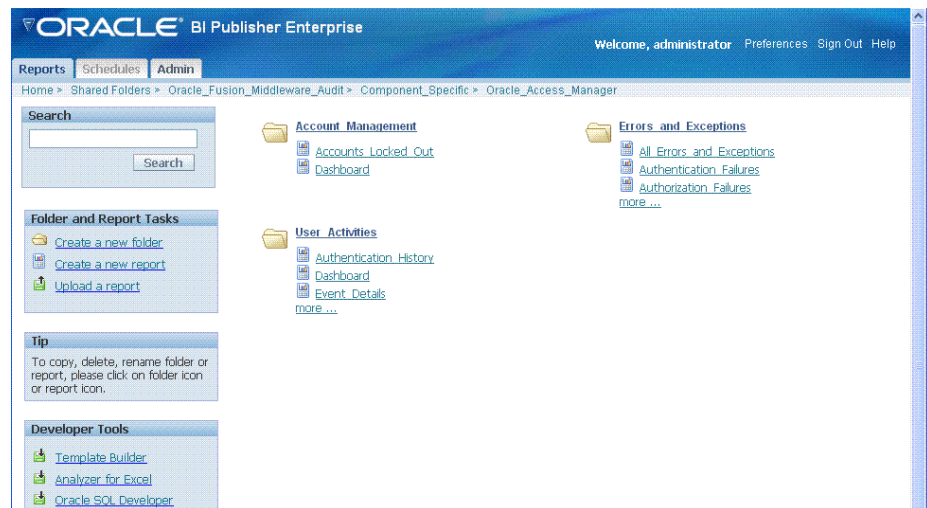

- c. Perform any analysis as desired, or edit your auditing configuration as needed.
`$MW_HOME/user_projects/domains/base_domain/servers/oam_server1/logs/auditlogs/OAM/`
- 5. Archive and manage audit logs according to your company policies.**

Logging WebGate Event Messages

Each 10g and 11g WebGate instance can write information about its processes and states to a log file.

The logs can be configured to provide information at various levels of granularity. For example, you can record errors, errors plus state information, or errors, states, and other information to the level of a debug trace. You can also eliminate sensitive information from the logs.

This chapter provides the following sections.

- [Understanding Logging for WebGate instances](#)
- [About Log Configuration File Paths and Contents](#)
- [About Directing Log Output to a File or the System File](#)
- [Structure and Parameters of the WebGate Log Configuration File](#)
- [Activating and Suppressing Logging Levels](#)
- [Mandatory Log Configuration File Parameters](#)
- [Configuring Different Threshold Levels for Different Types of Data](#)
- [Filtering Sensitive Attributes](#)

9.1 Understanding Logging for WebGate instances

The logging feature enables you to analyze system performance and to troubleshoot issues.

You can configure logging for individual WebGate instances of the following components:

- 10g WebGates
- 11g WebGates
- Custom Access Clients (Access Manager SDK)

Note:

Unless explicitly stated, all information in this section applies equally to 10g and 11g WebGates. For instance, the location of the log configuration, `oblog_config_wg.xml`, has changed for 11g but the content of the file and most other specifics have not.

This section discusses the following topics:

- [About Logging, Log Levels, and Log Output](#)
- [Log Levels](#)
- [Log Output](#)

9.1.1 About Logging, Log Levels, and Log Output

You can configure different logging levels for different functional areas of a component instance.

For example, you can capture debug data for LDAP activity while recording only error-level data for all other component activity. You can also record the time taken for each request that a component processes, and you can send different levels of log data to different destinations. For example, you can send error information to a file and all other log data to the system log.

Securing Sensitive Information: Access Manager handles sensitive information about users. On some sites, this includes user password, date of birth, a social security number, security questions and answers for lost password requests. Sensitive data on your site might include a security number or other information you want to secure. At certain logging levels, sensitive information might be captured. Today, you can filter sensitive information out of log files, as described in "[Filtering Sensitive Attributes](#)".

Configuring Logging: You configure logging by editing a configuration file that is stored with the Webgate. See "[About Log Configuration File Paths and Contents](#)".

Logging Levels: You can request logging at various levels. The highest level is Fatal and the lowest level is Trace. See "[Log Levels](#)" for details.

Logging Destinations: In the log configuration file, a parameter known as a log writer determines the destination for log output. See "[About Directing Log Output to a File or the System File](#)" for details. You create a complete definition for your log output by identifying a log writer and a log level. This complete definition is known as a log-handler. See "[Parameters in the WebGate Second Compound List and Log Handlers](#)" for details.

9.1.2 Log Levels

A logging level determines the amount of data that is written to the log data file. Each logging level is cumulative, that is, each level contains all the data generated by the higher levels.

For example, Error logs contain all the data generated by the Fatal logs, plus the events that are specific to the Error category.

[Table 9-5](#) describes the levels. The default log level is Warning: LOGLEVEL_WARNING.

Table 9-1 Logging Levels

Level	Number of Events Reported	Description
LOGLEVEL_FATAL	> 60	Records critical errors. Generally, these events can cause the component to exit. In the event of a system failure, Fatal-level messages are always flushed to the log file.

Table 9-1 (Cont.) Logging Levels

Level	Number of Events Reported	Description
LOGLEVEL_ERROR	> 960	Records events that may require corrective action, for example, a component is unavailable. Error logs can also be generated for transient or self-correcting problems, for example, failure to connect to another component.
LOGLEVEL_WARNING	> 1200	Records issues that may lead to an error or require corrective action in the future.
LOGLEVEL_INFO	> 400	Records completed actions or the current state of a component, for example, the component is initializing.
LOGLEVEL_DEBUG1	> 400	Records debugging information. Typically, the information at this level is only meaningful to a developer.
LOGLEVEL_DEBUG2	> 100	Records advanced debugging information. This level augments the Debug1 log level. Typically, the information at this level is only meaningful to a developer.
LOGLEVEL_DEBUG3	> 900	Records a large amount of debugging information or data pertaining to an expensive section of the code. This level is useful for debugging a tight loop or a performance-sensitive function. Typically, the information at this log level is only meaningful to a developer. These logs can contain sensitive information.
LOGLEVEL_TRACE	> 900 Access Manager API > 150 third-party API	This log level is used to trace code path execution or to capture performance metrics. This information is captured at the entry and exit points for each component function. Typically, the information at this log level is only meaningful to a developer. These logs can contain sensitive information.
LOGLEVEL_ALL	> 5000	This level includes all the events and states from all other levels.

Compound Lists: You can collect log data from non-adjacent levels and send different levels of log data to different destinations. For example, you can send the Fatal logs to the system log, and write Error logs to a file. See "[Parameters in the WebGate Second Compound List and Log Handlers](#)" for details.

Threshold: You configure a global cutoff, or threshold, for logging on the LOG_THRESHOLD_LEVEL parameter in the log configuration file. By default, if a configured level for a log-handler exceeds the cutoff, the log data is not collected. Note that logs can fail to be written despite the configured level because the LOG_THRESHOLD_LEVEL parameter takes precedence over the level configured in the log-handler. Only the MODULE_CONFIG section of the log configuration file overrides the global threshold. See "[Parameters in the WebGate Simple List and Logging Threshold](#)" for details.

Overrides: You specify function- or module-specific overrides for the global logging threshold on the `MODULE_CONFIG` parameter. See ["Configuring Different Threshold Levels for Different Types of Data"](#) for details.

Note:

The Trace and Debug3 level logs can contain sensitive information. For more information about sensitive information, see ["Filtering Sensitive Attributes"](#).

9.1.3 Log Output

Each line of the log output file follows a particular structure. A line starts with a date and time stamp, followed by the thread that is processing the request, the name of the function or module being logged, and the log level.

The following is a snapshot of the left-most columns of the log output file:

```
2007/06/01@00:50:56.859000    5932  2672  DB_RUNTIME    DEBUG3
2007/06/01@00:50:56.859000    5932  2672  DB_RUNTIME    TRACE
2007/06/01@00:50:56.859000    5932  2672  LDAP          DEBUG1
2007/06/01@00:50:56.859000    5932  2672  LDAP          TRACE
2007/06/01@00:50:56.859000    5932  2672  LDAP          TRACE
```

The two columns to the right of the log level are internal code references, and can be ignored. The following is an example of these columns:

```
0x00000205    ldap_connection_mgr.cpp:212
```

To the right of the internal code reference columns, you see the log message that is associated with this log level, for example, "Function called" or "Function returned," followed by the name of the function, as illustrated in the following example:

```
"Function called"    _CallName^ldap_init
```

The log message and function name can be followed by additional information, for example, the duration of the process, the address space where the function is running, or state information, as illustrated in the following examples:

```
"Connection health check result"    Server^dlsun4072    Port^389    Server
Priority^1    Connection available^true
```

```
"Function entered"    _TraceName^ConnectionWatcherThread::CheckPrimaries
```

```
"Function exited"    _TraceName^ConnectionWatcherThread::CheckPrimaries
TraceDuration^0.000028
```

```
"Connection Pool Status in ValidateConnections()"    "NumLivePrimaryConnections^1
Maximum Connections^1    UpConnections^1    Failover Threshold^1    Max Session
Time^0    SleepFor^60
```

To secure sensitive information and ensure that it is not included in the output of the logging operation, see ["Filtering Sensitive Attributes"](#).

See Also:

["Log Configuration File Contents"](#)

9.2 About Log Configuration File Paths and Contents

The log configuration file, `oblog_config_wg.xml`, is used to specify configuration details for WebGate logging (oblogs). You configure parameters that control WebGate log output in XML-based log files that can be edited with a plain text editor. Changes made to these files are effective immediately.

Details are in the following sections:

- [Log Configuration File Paths and Names](#)
- [Log Configuration File Contents](#)

9.2.1 Log Configuration File Paths and Names

By default, WebGate logging is enabled and oblogs are generated in the Oracle HTTP Server (OHS) instance diagnostics directory: `instance1/diagnostics/logs/OHS/ohs1/`.

Each WebGate instance includes a log configuration file (`oblog_config_wg.xml`) where you can define what type of data is recorded in the log output. A log configuration file is distinct from the log output file. For details on log output files, see "[Log Output](#)"

The `oblog_config_wg.xml` file is updated when you edit to configure WebGate logging. For example, by setting a new log threshold level, changing a log file name, or filtering logs related to some modules and so on.

Log configuration, `oblog_config_wg.xml`, files reside in the following locations depending upon your WebGate version:

10g WebGates: `Webgate_install_dir\oblix\config`

11g WebGates: `$WEBGATE_HOME` or `$ORACLE_HOME/webgate/ohs/config`. The same `oblog_config_wg.xml` file is copied to the WebGate instance directory (`$INSTANCE_HOME/webgate/config`) when the WebGate instance is created. The later is to be used when configuring logging.

Note:

Do not change the path to this file. If you install more than one instance, a log configuration file is installed for each instance. When configuring logging, `oblog_config_wg.xml` under `$INSTANCE_HOME` should be updated.

After installation, `oblog_config_wg.xml` and `oblog_config_wg_original.xml` both contain comments to help guide your editing.

[Table 9-2](#) lists the names of the log configuration files. Do not change the names.

Table 9-2 Log Configuration File Names for Components

Component	Log Configuration File Name
Webgate	<code>oblog_config_wg.xml</code>
Access Manager SDK (custom Access Client)	<code>oblog_config.xml</code>

Note:

Do not change the default path or name for any logging configuration file.

The `oblog_config_wg.xml` file can be edited using any text editor as long as you ensure that after the update the file is still valid XML. After updates to the file, changes will take affect in about 60 seconds.

9.2.2 Log Configuration File Contents

The configuration file controls log items such as file rotation intervals and it contains XML statements that you can edit in a text editor.

The log configuration file controls items such as the following:

- What is logged for that component
- Where the data is sent
- In certain cases, the size of the write buffer used for the log
- Log file rotation intervals

9.2.2.1 When Changes to the File Take Effect

A watcher thread picks up changes to the log configuration file every 60 seconds and ensures that changes take effect. It is unnecessary to restart the server.

9.2.2.2 Comments in the Log File

Each default log configuration file contains comments that are intended to assist with editing the file.

See Also:

The log configuration file on your system.

The commented default configuration file is shown here:

Comments can span one or multiple lines. Comments look similar to the following:

```
<!--NetPoint Logging Configuration File -->
<!-- -->
<!--Changes to this file will be automatically taken into effect -->
<!--in one minute. This does not require any server restart. -->
```

Following example shows a typical log configuration file with comments.

```
<?xml version="1.0" encoding="ISO-8859-1" ?>
<!--===== -->
<!--===== -->
<!--NetPoint Logging Configuration File -->
<!-- -->
<!--Changes to this file will be automatically taken into effect -->
<!--in one minute. This does not require any server restart. -->
<!-- -->
<!--===== -->
```

```

<!-------> -->
<!--Set the Log Threshold -->
<!-->
<!--The log Threshold determines the amount of information to log. -->
<!--Selecting a lower level of logging includes the information -->
<!--logged at the higher levels. For example, LOGLEVEL_ERROR -->
<!--includes the information collected at LOGLEVEL_FATAL. -->
<!-->
<!--Choices are: -->
<!--LOGLEVEL_FATAL - serious error, possibly a program halt. -->
<!--LOGLEVEL_ERROR - a transient or self-correcting problem. -->
<!--LOGLEVEL_WARNING - a problem that does not cause an error. -->
<!--LOGLEVEL_INFO - reports the current state of the component. -->
<!--LOGLEVEL_DEBUG1 - basic debugging information. -->
<!--LOGLEVEL_DEBUG2 - advanced debugging information. -->
<!--LOGLEVEL_DEBUG3 - logs performance-sensitive code. -->
<!--LOGLEVEL_TRACE - used when you need to trace the code path -->
<!--execution or capture metrics. Includes all previous levels. -->
<!--
<!--If you do not specify a threshold, the default is WARNING. -->
<!--
<!--In addition to specifying a threshold, you need to specify -->
<!--if changes that you make to the logging configuration in -->
<!--the NetPoint GUI overwrite the settings in this file. The -->
<!--AutoSync parameter accomplishes this. This parameter takes a -->
<!--value of True or False. If set to True, changes made in the -->
<!--GUI overwrite changes in this config file. If False, changes -->
<!--made in the GUI are only in effect until the server is -->
<!--stopped or restarted, after which the settings in this file -->
<!--overwrite the GUI settings. The default is True. -->
<!--
<!--
<CompoundList xmlns="http://www.oblix.com" ListName="logframework.xml.staging">
  <SimpleList>
    <NameValPair ParamName="LOG_THRESHOLD_LEVEL" Value="LOGLEVEL_WARNING" />
    <NameValPair ParamName="AUTOSYNC" Value="True" />
    <!-- SECURE_LOGGING flag can be used to turn on/off Secure Logging --> <!--
feature. By defalut this feature is tunred on. -->
    <NameValPair ParamName="SECURE_LOGGING" Value="On" />
    <!-- In addition to specifying a log threshold, you need to -->
    <!-- configure log level for which Secure Logging should be -->
    <!-- applicable.Choices for this can be used same as that of -->
    <!-- LOG_THRESHOLD_LEVEL. Secure log threshold can be set using -->
    <!-- LOG_SECURITY_THRESHOLD_LEVEL flag. Default value for Secure -->
    <!-- log threshold is TRACE. -->
    <NameValPair ParamName="LOG_SECURITY_THRESHOLD_LEVEL"
Value="LOGLEVEL_TRACE" />
    <!-- LOG_SECURITY_ESCAPE_CHARS is used to configure escape sequence -->
    <!-- characters. This can be used to avoid additional information -->
    <!-- getting overwritten due to Secure Logging mechanism. Currently -->
    <!-- following characters have been identified as escape sequence. -->
    <!-- Configuring inappropriate characters may lead to sensitive -->
    <!-- information being unmasked. -->
    <NameValPair ParamName="LOG_SECURITY_ESCAPE_CHARS" Value="),]" />
    <!-- LOG_SECURITY_MASK_LENGTH is used to specify default masking -->
    <!-- length if none is specified in FILTER_LIST. -->
    <!-- Default value for LOG_SECURITY_MASK_LENGTH is 300. -->
    <NameValPair ParamName="LOG_SECURITY_MASK_LENGTH" Value="300" / >
  </SimpleList>
<!--
<!--

```

```

<!--===== -->
<!--===== -->
<!--Configure the Log Level -->
<!-- -->
<!-- -->
<!--To configure a log level, you specify a name for the -->
<!--configuration (for instance, MyErrorLog1) and -->
<!--the log level that you are configuring. You can create -->
<!--more than one configuration per log level if you want -->
<!--to output to more than one destination. You can output to -->
<!--the system log or to a file, as specified on -->
<!--the LOG_WRITER parameter. The value for the LOG_WRITER -->
<!--parameter may only be SysLogWriter, FileLogWriter or -->
<!--MPFileLogWriter. The MPFileLogWriter is a multi-process safe -->
<!--FileLogWriter. It should be used to log in webcomponents i.e -->
<!--Webgate loaded on multiprocess -->
<!--web servers like Apache and IPlanet(UNIX) -->
<!-- -->
<!--If you do not specify an output destination, the default is -->
<!--SysLogWriter. -->
<!-- -->
<!--If outputting to a file, you also specify a file name and -->
<!--other parameters. Default parameter values are: -->
<!--FILE_NAME: <installdir>/oblix/log/oblog.log -->
<!--BUFFER_SIZE: 32767 (number of bytes) -->
<!--MAX_ROTATION_SIZE: 5242880 (bytes, equivalent to 5MB) -->
<!--MAX_ROTATION_TIME: 86400 (seconds, equivalent to one day) -->
<!-- -->
<!--Configuring the log level does not ensure that the data is -->
<!--actually collected. Data collection for a log is -->
<!--determined by the LOG_THRESHOLD_LEVEL parameter, above, -->
<!--and the LOG_STATUS parameter in the log configuration. -->
<!-- -->
<!--If you do not provide a LOG_STATUS, the default for -->
<!--LOGLEVEL_FATAL, LOGLEVEL_ERROR, and LOGLEVEL_WARNING, -->
<!--is On. -->
<!-->
<!--This file contains several sample configurations that are -->
<!--enclosed in comments. To use them, remove the comments. -->
<!--
<CompoundList xmlns="http://www.oblix.com" ListName="LOG_CONFIG">
  <!--Write all FATAL logs to the system logger. -->
  <ValNameList xmlns="http://www.oblix.com" ListName="LogFatal2Sys">
    <NameValPair ParamName="LOG_LEVEL" Value="LOGLEVEL_FATAL" />
    <NameValPair ParamName="LOG_WRITER" Value="SysLogWriter" />
    <NameValPair ParamName="LOG_STATUS" Value="On" />
  </ValNameList>
  <!--Write all logs to the Oracle log file. -->
  <ValNameList xmlns="http://www.oblix.com" ListName="LogAll2File">
    <NameValPair ParamName="LOG_LEVEL" Value="LOGLEVEL_ALL" />
    <NameValPair ParamName="LOG_WRITER" Value="FileLogWriter" />
    <NameValPair ParamName="FILE_NAME" Value="oblog.log" />
    <!-- Buffer up to 64 KB (expressed in bytes) of log entries before
flushing to the file. -->
    <NameValPair ParamName="BUFFER_SIZE" Value="65535" />
    <!--Rotate the log file once it exceeds 50 MB (expressed in bytes). -->
    <NameValPair ParamName="MAX_ROTATION_SIZE" Value="52428800" />
    <!--Rotate the log file after 24 hours (expressed in seconds). -->
    <NameValPair ParamName="MAX_ROTATION_TIME" Value="86400" />
    <NameValPair ParamName="LOG_STATUS" Value="On" />
  </ValNameList>

```

```

    </CompoundList>
    <!-- List of values that can be specified in the module config -->
    <!--
    <!-- On - Uses loglevel set in the loglevel threshold -->
    <!-- Off - No information is logged -->
    <!-- LOGLEVEL_FATAL - serious error, possibly a program halt. -->
    <!-- LOGLEVEL_ERROR - a transient or self-correcting problem. -->
    <!-- LOGLEVEL_WARNING - a problem that does not cause an error. -->
    <!-- LOGLEVEL_INFO - reports the current state of the component. -->
    <!-- LOGLEVEL_DEBUG1 - basic debugging information. -->
    <!-- LOGLEVEL_DEBUG2 - advanced debugging information. -->
    <!-- LOGLEVEL_DEBUG3 - logs performance-sensitive code. -->
    <!-- LOGLEVEL_TRACE - used when you need to trace the code path -->
    <!-- execution or capture metrics. Includes all previous levels. -->
    <!--
    <!-- List of modules that can be specified in the module config -->
    <!--
    <!-- ALL_MODULES - Applies to all log modules -->
    <!-- Specific module name - Applies to specific module -->
    <!--
    <!--
    <!-- <ValNameList -->
    <!--     xmlns="http://www.oblix.com" -->
    <!--     ListName="MODULE_CONFIG"> -->
    <!--     <NameValPair -->
    <!--         ParamName="CONNECTIVITY" -->
    <!--         Value="LOGLEVEL_TRACE"></NameValPair> -->
    <!--     </ValNameList> --><!-- <!--
    FILTER_LIST is used to maintain list of attributes which need -->
    <!-- to be treated as sensitive and hence will be filtered out from -->
    <!-- from logs. FILTER_LIST consist of all attribute names along -->
    <!-- with corresponding masking lengths. There should be separate -->
    <!-- entry in the list for the display name of the attribute -->
    <!-- identified as sensitive. All attributes configured are case -->
    <!-- sensitive i.e. if we configured sensitive attribute homePhone -->
    <!-- as HomePhone then it will not get filtered out from logs. -->
    <!-- By default four attributes (password, Password, response and -->
    <!-- Response) are configured as sensitive -->
    <!-- A sample configuration is shown below -->

    <!-- <ValNameList -->
    <!--     xmlns="http://www.oblix.com" -->
    <!--     ListName="FILTER_LIST"> -->
    <!--     <NameValPair -->
    <!--         ParamName="password" -->
    <!--         Value="40"></NameValPair> -->
    <!--     <NameValPair -->
    <!--         ParamName="Password" -->
    <!--         Value="40"></NameValPair> -->
    <!--     <NameValPair -->
    <!--         ParamName="response" -->
    <!--         Value="40"></NameValPair> -->
    <!--     <NameValPair -->
    <!--         ParamName="Response" -->
    <!--         Value="40"></NameValPair> -->
    <!--     <NameValPair -->
    <!--         ParamName="homePhone" -->
    <!--         Value="40"></NameValPair> -->
    <!--     </ValNameList> -->
    <ValNameList xmlns="http://www.oblix.com" ListName="FILTER_LIST">
        <NameValPair ParamName="password" Value="40" />

```

```

<NameValPair ParamName="Password" Value="40" />
<NameValPair ParamName="passwd" Value="40" />
<NameValPair ParamName="Passwd" Value="40" />
<NameValPair ParamName="response" Value="40" />
<NameValPair ParamName="Response" Value="40" />
</ValNameList>
</CompoundList>

```

9.3 About Directing Log Output to a File or the System File

To send log output to a destination, you configure a log writer.

A log writer can send log output to one, none, or both of the following:

- A log file.
This file resides under the root installation directory of the component.
- The system file of the host for the component.
If more than one component resides on the same host, all components send data to the system log file on that host.

You can send logs of a particular level, or logs of different levels, to more than one type of log writer. For instance, you can send Fatal data to the system log, and send Trace data to a file. Or, you can send Fatal data to both the system log and a file.

You define log writers in the log configuration file using the `LOG_WRITER` parameter in a log-handler definition. See "[Parameters in the WebGate Second Compound List and Log Handlers](#)" for details.

The log writers are described in [Table 9-3](#).

Table 9-3 Log Writers

Writer	Description
<code>SysLogWriter</code>	<p>Sends data to the system log file for the computer that hosts the component being logged. Typically, the system log file contains event information from multiple applications and the host operating system.</p> <p>For Windows, this is the application log file located at My Computer, Manage, Event Viewer, Application.</p> <p>For UNIX platforms, the name and location of the system log file can vary according to the computer and the preferences of the system Administrator. Consult the Administrator of the computer for the file location.</p> <p>The default log configuration file sends Fatal, Error, and Warning messages to the system log file.</p>
<code>FileLogWriter</code>	<p>This writer is recommended when you want to save log data for an OAM Server or other single-process application on a disk file.</p> <p>The <code>FileLogWriter</code> opens the log file and holds it open for disk writes until the approximate file size limit or file rotation interval has been reached. Oracle does not recommend this log writer for situations where more than one process needs to write to the same log file. For these situations, use the <code>MPFileLogWriter</code>.</p>

Table 9-3 (Cont.) Log Writers

Writer	Description
MPFileLogWriter	<p>This writer resembles the FileLogWriter, except that it opens and closes the log file each time it writes data to the file. This enables multiple processes to write to the file in turn. However, this practice can slow performance substantially.</p> <p>Oracle recommends using MPFileLogWriter only when FileLogWriter fails to record logging data from some of the processes associated with a multi-process application, for example, an Access Client installed on a multi-process Web server (such as Apache) or the Solaris version of the iPlanet Web server.</p>

9.4 Structure and Parameters of the WebGate Log Configuration File

The log configuration file conforms to a standard format. You can edit parameters and add or subtract sections known as log-handler definitions, but do not change the underlying format of the log configuration file.

The rest of this section discusses the following topics:

- [Structure of WebGate Log Configuration XML File Header](#)
- [Structure of WebGate Initial Compound List](#)
- [Parameters in the WebGate Simple List and Logging Threshold](#)
- [Parameters in the WebGate Second Compound List and Log Handlers](#)
- [Parameters in the WebGate List for Per-Module Logging](#)
- [Parameters in the WebGate Filter List](#)
- [WebGate XML Element Order](#)

9.4.1 Structure of WebGate Log Configuration XML File Header

The XML file header is available at the beginning of the log configuration file.

```
<?xml version="1.0" encoding="ISO-8859-1" ?>
```

The header serves the following purposes:

- The header declares the relevant XML version, which is always 1.0.
- It also declares the encoding format, which is always ISO-8559-1.

9.4.2 Structure of WebGate Initial Compound List

The header is followed by an initial compound list.

The initial compound list is delimited as follows:

```
<CompoundList xmlns="http://www.oblix.com" ListName="logframework.xml.staging">
. . .
</CompoundList>
```

The first compound list is structured as follows:

- The compound list start-tag shows the relevant XML name space for the log configuration file in the `xmlns` parameter.
- The compound list start-tag also provides a name for the compound list in the `ListName` parameter.
- The compound list end-tag occurs near the end of the file.
This compound list delimits all log configuration information.

9.4.3 Parameters in the WebGate Simple List and Logging Threshold

After the start-tag for the first compound list, a simple list sets the global defaults for logging.

The start and end tags for this list are as follows:

```
<SimpleList>
. . .
</SimpleList>
```

Between the start and end tags of the simple list, you configure the following:

Table 9-4 Global Parameters in the First Compound List

Parameter	Description
LOG_LEVEL_THRESHOLD	<p>Sets the default logging threshold.</p> <p>Default value: LOGLEVEL_WARNING</p> <p>Possible Values: Refer to log levels in "Log Levels"</p> <p>The global threshold allows logs of a particular level and more general levels to be collected, and prevents lower-level logs from being collected. This threshold can be overridden by a per-module threshold. See "Configuring Different Threshold Levels for Different Types of Data" for details.</p>
SECURE_LOGGING	<p>Dynamically enables or disables the secure logging mechanism. This does not require a server or component restart.</p> <p>Default value: On</p> <p>Possible Values: On or Off</p>
LOG_SECURITY_THRESHOLD_LEVEL	<p>Indicates the log threshold for which secure logging is effective.</p> <p>Default value: LOGLEVEL_TRACE</p> <p>Possible Values: Refer to log levels in "Log Levels"</p> <p>Note: Ensure that LOG_THRESHOLD_LEVEL and LOG_SECURITY_THRESHOLD_LEVEL are the same or are consistent with one another. For example, if LOG_THRESHOLD_LEVEL is set to LOGLEVEL_TRACE while LOG_SECURITY_THRESHOLD_LEVEL is set at LOGLEVEL_WARNING, then secure logging applies to LOGLEVEL_WARNING and above but does not apply to LOGLEVEL_TRACE.</p>

Table 9-4 (Cont.) Global Parameters in the First Compound List

Parameter	Description
LOG_SECURITY_ESCAPE_CHARS	<p>Configure escape sequence characters used to avoid additional information being overwritten due to the secure logging mechanism. Use a comma separated list as shown here.</p> <p>Default value:),]</p> <p>Possible Values: Characters only</p> <p>Note: Default values are recommended. Configuring inappropriate characters may lead to sensitive information being unmasked.</p>
LOG_SECURITY_MASK_LENGTH	<p>Specifies the default masking length if none is specified in FILTER_LIST.</p> <p>Default value: 300</p> <p>Possible Values: Positive integer</p> <p>Note: FILTER_LIST appears after the second compound list (log handlers). For more information, see "Filtering Sensitive Attributes".</p>

Following example shows the simple lists containing global settings, which appear in the first compound list in the oblog_config_wg.xml file.

```
<SimpleList>
  <NameValPair
    ParamName="LOG_THRESHOLD_LEVEL"
    Value="LOGLEVEL_WARNING">
  </NameValPair>
  <NameValPair
    ParamName="AUTOSYNC"
    Value="True">
  </NameValPair>
  <NameValPair
    ParamName="SECURE_LOGGING"
    Value="On">
  </NameValPair>
  <NameValPair
    ParamName="LOG_SECURITY_THRESHOLD_LEVEL"
    Value="LOGLEVEL_TRACE">
  </NameValPair>
  <NameValPair
    ParamName="LOG_SECURITY_ESCAPE_CHARS"
    Value="),]">
  </NameValPair>
  <NameValPair
    ParamName="LOG_SECURITY_MASK_LENGTH"
    Value="300">
  </NameValPair>
</SimpleList>
```

9.4.4 Parameters in the WebGate Second Compound List and Log Handlers

After the simple list containing global settings, and within the start and end tags for the initial compound list, you specify an additional compound list. This compound list contains log-handler definitions.

The start and end tags for this list are as follows:

```
<CompoundList xmlns="http://www.oblix.com" ListName="LOG_CONFIG">
. . .
</CompoundList>
```

This compound list tag is configured as follows:

- In the start tag for the compound list, the `xmlns` parameter indicates the relevant XML name space.
- Also in the start tag, you specify the name of the list on the `ListName` parameter. Typically, the name of this list is `LOG_CONFIG`.

Between the start and end tags for the compound list for the log-handler, you specify one or more `ValNameList` elements. Each `ValNameList` element contains the definition for a log-handler. Each instance of this element begins and ends as follows:

```
<ValNameList xmlns="http://www.oblix.com" ListName="Unique_Name">
. . .
</ValNameList>
```

The `ValNameList` elements are configured as follows:

- The opening tag sets the relevant XML name space on the `xmlns` parameter.
- The opening tag also sets a name for the log-handler on the `ListName` parameter.

Within the opening and closing `ValNameList` tags, you configure the log-handler. A log-handler definition contains three mandatory `NameValPair` elements:

- The first mandatory `NameValPair` element defines the logging level for the log-handler.

This element contains the statement `ParamName="LOG_LEVEL"`, whose value is a reserved name in [Table 9-1](#), as follows:

```
<NameValPair ParamName="LOG_LEVEL" Value="LOGLEVEL_FATAL" />
```

- The second mandatory `NameValPair` element defines the destination for log output.

This element contains a statement `ParamName="LOG_WRITER"`, whose value is a reserved name in [Table 9-3](#), as follows:

```
<NameValPair ParamName="LOG_WRITER" Value="SysLogWriter" />
```

- The third mandatory `NameValPair` element toggles this log-handler on and off.

This element contains a statement `ParamName="LOG_STATUS"`, with a value of `On` or `Off`, as follows:

```
<NameValPair ParamName="LOG_STATUS" Value="On" />
```

Finally, within the opening and closing `ValNameList` tags, if you specify `FileLogWriter` or `MPFileLogWriter` as the log writer, you can add none, some, or all of the following. See [Table 9-7](#) for details:

- A destination file name, as follows:

```
<NameValPair ParamName="FILE_NAME" Value="oblog.log" />
```

- A buffer size, as follows:

```
<NameValPair ParamName="BUFFER_SIZE" Value="65535" />
```

- A file size that determines when a new log file is generated, as follows:

```
<NameValPair ParamName="MAX_ROTATION_SIZE" Value="52428800" />
```

- A time in minutes that determines the interval at which a new log file is generated, as follows:

```
<NameValPair ParamName="MAX_ROTATION_TIME" Value="86400" />
```

9.4.5 Parameters in the WebGate List for Per-Module Logging

After the end tag for the compound list that delimits the log-handlers, and before the end tag for the initial compound list, you can add per-module logging parameters.

See "[Configuring Different Threshold Levels for Different Types of Data](#)" for details.

9.4.6 Parameters in the WebGate Filter List

After the per-module logging parameters a filter list identifies sensitive information that you might want to filter out of the log file. For example, passwords and responses for lost password management are sensitive information that you might want to filter out of the log file.

Each name value pair associated with the FILTER_LIST parameter provides the name of a word or phrase to be checked before the log is written and the corresponding masking length for that word or phrase. During logging, the value of the word or phrase is masked and omitted from the log file.

Simply put, during logging Access Manager does not recognize whether a value to be masked is an attribute or its display name or something different (plain text). Secure Logging works by searching for words or phrases added in the FILTER_LIST and then masking out any data that is followed by the occurrence of those words or phrases. For example, in the following statement:

```
\csabuild\coreid1014\np_common\db\ldap\util\ldap_util3.cpp:3107 "ldap_parse_result
of Simple Bind"          ld handle^0x0779FA00          result^0x09FB0088
bind^cn=orcladmin        LDAP bind operation status code^0          Additional
error message^ freeit^0 parse_rc^0
```

After turning Secure Logging ON and adding "bind" in the FILTER_LIST (which is neither an attribute nor a display name), whatever follows the word in the FILTER_LIST (in this case, "bind") is masked. In this case, you would see the following in logs:

```
\csabuild\coreid1014\np_common\db\ldap\util\ldap_util3.cpp:3107 "ldap_parse_result
of Simple Bind"          ld handle^0x0779FA00          result^0x09FB0088
bind^cn=orcladmin        LDAP bind***** status code^0          Additional
error message^ freeit^0 parse_rc^0
```

All attributes are case sensitive. For example, if you enter "password" instead of "Password" as a display name for an attribute, then "Password" is not filtered. By default, four attributes are always configured in the filter list: password, Password, response, and Response.

The default masking length, 40, is specified for each of the four default attributes. The default mask length can be altered for the default attributes if needed. If you add other attributes to the filter list, you might need a larger mask length (300, for example).

The default filter list is shown in the following example:

```

<ValNameList>
  xmlns="http://www.oblix.com"
  ListName="FILTER_LIST">
    <NameValPair
      ParamName="password"
      Value="40"></NameValPair>
    <NameValPair
      ParamName="Password"
      Value="40"></NameValPair>
    <NameValPair
      ParamName="passwd"
      Value="40"></NameValPair>
    <NameValPair
      ParamName="Passwd"
      Value="40"></NameValPair>
    <NameValPair
      ParamName="response"
      Value="40"></NameValPair>
    <NameValPair
      ParamName="Response"
      Value="40"></NameValPair>
  </SimpleList>

```

When you add another attribute to the filter list, you must include the display name as well as the attribute name in the directory server.

9.4.7 WebGate XML Element Order

When using XML, you can specify parallel elements in a list in any order as long as the elements remain intact and within the tags that originally bracketed them.

For example, the lists in the following examples are equivalent:

```

<ValNameList xmlns="http://www.example.com" ListName="LogError2Sys">
  <NameValPair ParamName="LOG_LEVEL" Value="LOGLEVEL_ERROR" />
  <NameValPair ParamName="LOG_WRITER" Value="SysLogWriter" />
  <NameValPair ParamName="LOG_STATUS" Value="On" />
</ValNameList>

```

```

<ValNameList xmlns="http://www.example.com" ListName="LogError2Sys">
  <NameValPair ParamName="LOG_WRITER" Value="SysLogWriter" />
  <NameValPair ParamName="LOG_LEVEL" Value="LOGLEVEL_ERROR" />
  <NameValPair ParamName="LOG_STATUS" Value="On" />
</ValNameList>

```

Similarly, within a given tag, the attributes (except for the tag name, which must always be the first element within the tag brackets) can be reordered, as long as they remain intact and within the tag elements that originally bracketed them. The opening tags for a name-value list in the following examples are equivalent:

```

<ValNameList xmlns="http://www.example.com" ListName="LogError2Sys">
  <ValNameList ListName="LogError2Sys" xmlns="http://www.example.com">

```

9.5 Activating and Suppressing Logging Levels

For a particular log-handler, the active status of a logging level is determined by a set of factors.

[Table 9-5](#) lists these factors.

Table 9-5 Factors that Determine Whether Logging Is Active

Factor	Importance	Description
LOG_THRESHOLD_LEVEL	Primary	This parameter sets a cutoff for logging. Any log level that is more detailed than the threshold is suppressed. See Table 9-1 for valid log levels. You override this parameter for a subset of items that can be logged using the MODULE_CONFIG parameter. See " Configuring Different Threshold Levels for Different Types of Data " for details.
MODULE_CONFIG	Primary	This sets a per-module override for the global logging threshold. See " Configuring Different Threshold Levels for Different Types of Data " for details.
LOG_STATUS	Secondary	This parameter toggles logging on or off, as long as it is not overridden by the logging threshold or a module-specific override.
The physical position of a log handler	Secondary	See " About Log Handler Precedence ".

9.5.1 About Log Handler Precedence

You can configure up to three log-handler definitions for a single log level in a log configuration file.

Three different log handlers are required to send output for a particular log level to each of the three log writers described in [Table 9-3](#).

If you specify different LOG_STATUS settings in these log handlers, the setting in the log-handler definition closest to the physical end of the log configuration file sets the status for the other log-handler definitions of the same log level. For example, you can set LOG_STATUS to *Off* for the first two log handlers for the Error log level, but if LOG_STATUS is *On* for the third and final log handler in the configuration file, logging still occurs for all three handlers.

The LOG_STATUS settings are moot if that level is more fine-grained than the current LOG_THRESHOLD_LEVEL. In this case, logging cannot be activated at this level unless the threshold is overridden by a module-specific threshold. See "[Configuring Different Threshold Levels for Different Types of Data](#)" for details.

9.6 Mandatory Log Configuration File Parameters

At minimum, each log-handler definition contains five parameters.

The parameters are listed in [Table 9-6](#).

Table 9-6 Mandatory Log Configuration File Parameters

Parameter	Comment
xmlns	This parameter is specified in the opening <code>ValNameList</code> tag. It specifies the relevant XML namespace for the current list and is identical for all log-handler definitions in a given logging configuration file. Example: <code>http://www.example.com</code>
ListName	This parameter is specified in the opening <code>ValNameList</code> tag. Where possible, use the default names. When creating a new log-handler definition, select a memorable name that you cannot confuse with other log handlers. Examples: <code>WarningsAndAboveToSyslog</code> sends Fatal, Error, and Warning messages to the system log file. <code>WarningsOnlyToFileLog128KBuffer</code> sends messages from just the Warning level to a 128KB buffer, and hence to a disk file. <code>TraceOnlyToMPRotateDaily</code> sends messages from just the Trace level to the multi-process file writer, which opens and closes the file each time it writes to disk. This file is replaced with a fresh (empty) file every day, regardless of the size of the file at the time of replacement.
LOG_LEVEL	This specifies a log level. See Table 9-1 for details. The default logging configuration file activates logging for three levels: Fatal, Error, and Warning.
LOG_WRITER	This specifies the destination for log output for this log-handler. See Table 9-3 for details. The default log configuration file sends output to both the system log and the log data file for the component doing the logging.
LOG_STATUS	This parameter turns the log handler on or off.

If you specify `FileLogWriter` or `MPFileLogWriter` as the value for the `LOG_WRITER` parameter, the four parameters in [Table 9-7](#) are relevant.

Table 9-7 Log Data File Configuration Parameters

Parameter	Description	Default
FILE_ NAME	<p>Mandatory. Used only for the FileLogWriter or MPFileLogWriter. It is the name and location of the file where log data is written.</p> <p>You can prepend an absolute path to the file name to store it somewhere other than the default location, which is:</p> <p><i>component_install_dir\oblix\logs</i></p> <p>Where <i>component_install_dir</i> is the root installation directory for the component whose system events you are logging.</p> <p>When you create more than one log-handler definition that sends output to FileLogWriter or MPFileLogWriter, provide unique file names so that multiple handlers do not write to the same file. This caution does not apply to log handlers accessing the SysLogWriter.</p>	oblog.log
BUFFER_SIZE	<p>Optional. This is the size of the buffer, in bytes, for logged data as it is being written to the log file.</p> <p>If you set the buffer value to 0 or a negative number, the default value is used. To write to the log file immediately, without buffering, set the value to a small number, for example, 5. Oracle recommends that you set a small buffer size in situations where there are system failures.</p>	65535 (64KB)
MAX_ ROTATION_ SIZE	<p>Optional. When the log file reaches this size (in bytes), a time stamp is appended to the file name, for example oblog.log becomes oblog.log1081303126. New data is written to the file with the original name.</p>	52428800 (512KB)
MAX_ ROTATION_ TIME	<p>Optional. A time interval, in seconds, when the log file is renamed, whether or not it has reached the maximum rotation size.</p> <p>If the rotation time determines when the file is rotated, the numbers appended to the log files differ by the number of seconds in the rotation interval. For example, oblog.log.1081389526 and oblog.log.1081303126 differ by 84,600, which is the number of seconds in 24 hours. This is the rotation interval set in the log configuration file.</p>	86400 (1 day, in seconds)

The following sections contain more information.

- [Settings in the Default Log Configuration File](#)
- [Description of the Settings in the Default Log Configuration File](#)

9.6.1 Settings in the Default Log Configuration File

As installed with each component, the log configuration file activates only the highest three levels (Fatal, Error, and Warning) and directs all log output to the system log.

On Windows, you can view the system log for the computer that hosts the component you are logging by navigating to My Computer, Manage, Event Viewer, Application. System event entries for the components being logged are interspersed among the system events for the operating system and applications other than Access Manager.

For Solaris and Linux environments, the location of the system log is recorded in a system configuration file whose particulars can vary from computer to computer. For the name and location of this system file or the system log, consult the owner of the computer that hosts the component whose system log you want to examine.

Following example shows the default log configuration file with comments removed to expose the file structure:

```
<?xml version="1.0" encoding="utf-8"?>
<CompoundList
  xmlns="http://www.oblix.com
  ListName="oblog_config_wg.xml.staging">
  <SimpleList>
    <NameValPair
      ParamName="LOG_THRESHOLD_LEVEL"
      Value="LOGLEVEL_WARNING"></NameValPair>
  </SimpleList>
  <SimpleList>
    <NameValPair
      ParamName="AUTOSYNC"
      Value="True"></NameValPair>
  </SimpleList>
  <SimpleList>
    <NameValPair
      ParamName="SECURE_LOGGING"
      Value="On"></NameValPair>
  </SimpleList>
  <SimpleList>
    <NameValPair
      ParamName="LOG_SECURITY_THRESHOLD_LEVEL"
      Value="LOGLEVEL_TRACE"></NameValPair>
  </SimpleList>
  <SimpleList>
    <NameValPair
      ParamName="LOG_SECURITY_ESCAPE_CHARS"
      Value="),,]"></NameValPair>
  </SimpleList>
  <SimpleList>
    <NameValPair
      ParamName="LOG_SECURITY_MASK_LENGTH"
      Value="300"></NameValPair>
  </SimpleList>
  <CompoundList
    xmlns="http://www.oblix.com"
    ListName="LOG_CONFIG">
    <ValNameList
      xmlns="http://www.oblix.com"
      ListName="LogFatal2Sys">
      <NameValPair
        ParamName="LOG_LEVEL"
        Value="LOGLEVEL_FATAL"></NameValPair>
      <NameValPair
        ParamName="LOG_WRITER"
        Value="SysLogWriter"></NameValPair>
      <NameValPair
        ParamName="LOG_STATUS"
```



```

        Value="On"></NameValPair>
</ValNameList>
<ValNameList
  xmlns="http://www.oblix.com"
  ListName="LogAll2File">
  <NameValPair
    ParamName="LOG_LEVEL"
    Value="LOGLEVEL_ALL"></NameValPair>
  <NameValPair
    ParamName="LOG_WRITER"
    Value="FileLogWriter"></NameValPair>
  <NameValPair
    ParamName="FILE_NAME"
    Value="oblog.log"></NameValPair>
  <NameValPair
    ParamName="BUFFER_SIZE"
    Value="65535"></NameValPair>
  <NameValPair
    ParamName="MAX_ROTATION_SIZE"
    Value="52428800"></NameValPair>
  <NameValPair
    ParamName="MAX_ROTATION_TIME"
    Value="86400"></NameValPair>
  <NameValPair
    ParamName="LOG_STATUS"
    Value="On"></NameValPair>
  </ValNameList>
</CompoundList>
<ValNameList
  xmlns="http://www.oblix.com"
  ListName="FILTER_LIST">
  <NameValPair
    ParamName="password"
    Value="40"></NameValPair>
  <NameValPair
    ParamName="Password"
    Value="40"></NameValPair>
  <NameValPair
    ParamName="passwd"
    Value="40"></NameValPair>
  <NameValPair
    ParamName="Passwd"
    Value="40"></NameValPair>
  <NameValPair
    ParamName="response"
    Value="40"></NameValPair>
  <NameValPair
    ParamName="Response"
    Value="40"></NameValPair>
  </ValNameList>
</CompoundList>

```

9.6.2 Description of the Settings in the Default Log Configuration File

The default configuration file sends Fatal, Error, and Warning messages to both the system log and to a log data file named oblog.log.

The simple list near the top of the file sets the following parameters:

- It sets the LOG_THRESHOLD_LEVEL to Warning.

The threshold suppresses logging for levels that are more fine-grained than Warning. You can override this threshold. See "[Configuring Different Threshold Levels for Different Types of Data](#)" for details.

The nested compound list contains four log-handler definitions:

- The first, named `LogFatal2Sys`, sets the logging level to `Fatal` and sets `LOG_STATUS` to `On`.

The threshold level is `Warning`, which is more fine-grained than `Fatal`, so this definition is in effect. The log output is written to the system log, as specified by the `LOG_WRITER` parameter.

- The `LogError2Sys` log-handler definition sends `Error` level messages to the system log.

`Error` is located before the current threshold level (`Warning`), so this definition is in effect.

- The `LogWarning2Sys` definition sends `Warning` level output to the system log. Like the two previous log-handler definitions, it is not overridden by the current `LOG_THRESHOLD_LEVEL` parameter.

- `LogAll2File`, the final log-handler definition, appears to send output from all log levels to a disk file named `oblog.log`.

The `LOG_THRESHOLD_LEVEL` parameter is set to `Warning`, so only the output from the `Fatal`, `Error`, and `Warning` levels are recorded in this log data file. Since output from `LogAll2File` goes to the `FileLogWriter`, the parameters governing file name, buffer size, rotation size, and rotation interval all take effect.

Figure 9-1 illustrates log-level activation in the default log confirmation file.

Figure 9-1 Log-Level Activation in the Default Log Configuration File

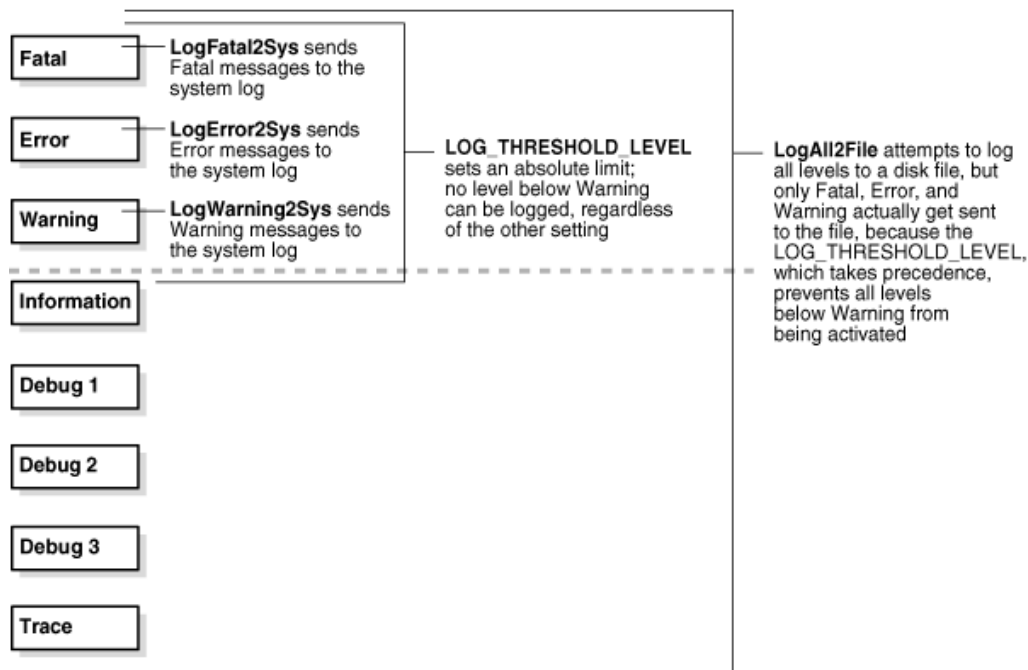

9.7 Configuring Different Threshold Levels for Different Types of Data

When diagnosing a problem, you may not want detailed logs for every operation that a component performs.

For example, to diagnose slow response times for requests that an Identity Server submits to its directory, you would want detailed information on LDAP operations and fewer details about other types of operations.

As of release 10.1.4.2, you can configure per-module or per-function threshold levels in the log configuration file, so that Access Manager generates detailed logs for some components while generating concise logs, or no logs, for others.

You configure per-module logging thresholds in a `MODULE_CONFIG` section in the `oblog_config_wg.xml` file. The `MODULE_CONFIG` section overrides the global default that you specify on the `LOG_THRESHOLD_LEVEL` in the simple list section of this file.

The rest of this section discusses the following topics:

- [About the MODULE_CONFIG Section](#)
- [Configuring a Log Level Threshold for a Function or Module](#)

9.7.1 About the MODULE_CONFIG Section

In addition to the global threshold, the configuration file can contain a `ValNameList` that defines function- or module-specific log thresholds. The name of this list is always `MODULE_CONFIG`.

As described in "[Structure and Parameters of the WebGate Log Configuration File](#)", in the log configuration file you configure a global logging threshold. The following is an example of the global `LOG_THRESHOLD_LEVEL` setting:

```
<SimpleList>
  <NameValPair ParamName="LOG_THRESHOLD_LEVEL" Value="LOGLEVEL_WARNING" />
  . . .
</SimpleList>
```

Only one instance of `MODULE_CONFIG` is permitted in the log configuration file, and the information in the list applies to all log writers defined in the file. As of release 10.1.4.2, the default log configuration file contains a commented sample of the `MODULE_CONFIG` list.

Each item in the `MODULE_CONFIG` list sets a logging level for a module, as shown in the following example:

```
<ValNameList xmlns="http://www.oblix.com" ListName="MODULE_CONFIG">
  <NameValPair ParamName="LDAP" Value="LOGLEVEL_TRACE"></NameValPair>
<NameValPair ParamName="DB_RUNTIME" Value="LOGLEVEL_TRACE"></NameValPair></
ValNameList>
```

The elements in this section are as follows:

- The `ValNameList` tag delimits the list of per-module logging thresholds.
- One `NameValPair` tag delimits each specific per-module logging threshold.
- The `ParamName` parameter sets the name of a module or function.

See [Table 9-8](#) for a list of valid values.

- The `Value` parameter sets the logging threshold for the module that you specify as a value for the `ParamName` parameter.

[Table 9-1](#) lists the permissible values for the `Value` parameter. In addition to these values, you can specify the value `ON` to enable logging for the module and a value of `OFF` to disable logging for the specific module.

The following sections contain more information.

- [Location of the Per-Module Logging Section in the Log Configuration File](#)
- [List of Modules That Can Be Logged](#)

9.7.1.1 Location of the Per-Module Logging Section in the Log Configuration File

You add the per-module logging threshold section near the end of the log configuration file, after the closing tag for the compound list for the log-handlers and before the closing tag for the first compound list in the file.

This section contains an example of the per-module logging section. See "[Configuring a Log Level Threshold for a Function or Module](#)" for details.

9.7.1.2 List of Modules That Can Be Logged

You can specify values for the `ParamName` parameter in the `MODULE_CONFIG` list.

[Table 9-8](#) describes the a partial list of values that can be logged.

Table 9-8 ParamName Values You Can Configure for Per-Module Logging Threshold

ParamName Value	Logging Threshold That This Parameter Sets
AAA_ACTIONS	<p>Sets a logging threshold for triggered actions that are configured as part of a policy in the OAM Server.</p> <pre><ValNameList xmlns="http://www.oblix.com" ListName="MODULE_CONFIG"> <NameValPair Paramname="AAA_ACTIONS" Value="OFF"> </NameValPair></pre>
AAA_AMENGINE	Sets a logging threshold for activity performed by the Access Manager engine.
AAA_ISRESRCOPPROT	Sets a logging threshold for all OAM Server activities related to determining if a resource operation is protected.
ACCESS_CLIENT	Sets a logging threshold for operations performed by an access client, that is, an Access Client or Webgate.
ACCESS_GATE	Sets a logging threshold for operations performed by an Access Client.
ACCESS_SDK	<p>Sets a logging threshold for operations performed by the Access Manager SDK interface.</p> <p>See the <i>Oracle Fusion Middleware Developer's Guide for Oracle Access Management</i> for details.</p>
ACCESS_SERVER	Sets a logging threshold for operations performed in the OAM Server.

Table 9-8 (Cont.) ParamName Values You Can Configure for Per-Module Logging Threshold

ParamName Value	Logging Threshold That This Parameter Sets
AM.SDK	Sets a logging threshold for the Access Manager SDK. See the <i>Oracle Fusion Middleware Developer's Guide for Oracle Access Management</i> for details.
AUDIT	Sets a logging threshold for auditing. See Auditing Administrative and Run-time Events for details.
AUTHENTICATION	Sets a logging threshold for user authentication operations.
AUTHN.MGMT	Sets a logging threshold for authentication scheme management.
AUTHN.PLUGIN	Sets a logging threshold for operations performed by an authentication plug-in.
AUTHORIZATION	Sets a logging threshold for user authorization operations.
AUTHZ.MGMT	Sets a logging threshold for authorization scheme management.
AUTHZ.PLUGIN	Sets a logging threshold for authorization plug-in operations.
CACHE	Sets a logging threshold for cache management and operations on the caches.
CONN.MGMT	Sets a logging threshold for connection management.
CONN.RUNTIME	Sets a logging threshold for connection run time.
CONNECTIVITY	Sets a logging threshold for client-sever connectivity and messaging.
DB.CONFIGURATION	Sets a logging threshold for the data store interface layer configuration.
DB.RUNTIME	Sets a logging threshold for the data store interface layer run time.
DIAGNOSTIC.FRAMEWORK	Sets a logging threshold for the diagnostic framework.
GROUPDB	Sets the threshold for logging accesses of Group Manager data in the directory.
GROUP.MGR	Sets the threshold for logging Group Manager operations.
HTTP.REQ	Sets the threshold for logging HTTP request processing.
IDXML	Sets the threshold for logging IDXML operations. See the <i>Oracle Fusion Middleware Developer's Guide for Oracle Access Management</i> for details.
LDAP	Sets a logging threshold for LDAP SDK, for example: <pre><ValNameList xmlns="http://www.oblix.com" ListName="MODULE_CONFIG"> <NameValPair Paramname="LDAP" Value="LOGLEVEL_TRACE"> </NameValPair></pre>

Table 9-8 (Cont.) ParamName Values You Can Configure for Per-Module Logging Threshold

ParamName Value	Logging Threshold That This Parameter Sets
NET	Sets a logging threshold for network APIs.
OBYMGROUPS	Sets a logging threshold for ObMyGroups processing. This refers to searches of groups where the person who initiated the search is a member.
OIS_CLIENT	Sets a logging threshold for the Identity client.
POLICY_MGMT	Sets a logging threshold for policy and policy domain management.
PPP	Sets a logging threshold for Identity Event Plug-in API operations. See the <i>Oracle Fusion Middleware Developer's Guide for Oracle Access Management</i> for details.
QUERY_BUILDER	Sets a logging threshold for Query Builder operations.
SECURITY	Sets a logging threshold for the security and encryption library.
SELECTOR	Sets a logging threshold for Selector operations.
SERVER	Sets a logging threshold for server infrastructure.
SSOTOKEN	Single sign-on token management.
UTILS	Sets a logging threshold for utility classes.
WEB	Sets a logging threshold for the Web server plug-in interface.
XML	Sets a logging threshold for the XML Infrastructure.

9.7.2 Configuring a Log Level Threshold for a Function or Module

You can configure a function- or module-specific log level threshold.

To configure:

1. Open the log configuration file in the following location:

```
Webgate_install_dir\identity\access\oblix\config
```

2. If a `ValNameList` section with a `ListName` of `MODULE_CONFIG` does not already exist in this file, create one that is similar to the following:

```
<ValNameList xmlns="http://www.oblix.com" ListName="MODULE_CONFIG">
</ValNameList>
```

Place this list after the end tag for the compound list that contains the log handler definitions. If there are comments immediately after this end tag, place the list after the comments.

3. Between the opening and closing tags of the new `ValNameList` element, configure one or more `NameValPair` elements.

This element contains a `ParamName` parameter and a `Value` parameter. See [Table 9-8](#) for the modules that you can supply on the `ParamName` parameter. See

[Table 9-1](#) for values, or you can specify a value of `On` or `Off`. The following is an example:

```
<NameValPair ParamName="LDAP" Value="LOGLEVEL_TRACE"></NameValPair>
```

You can specify multiple `ValNamePair` elements within the `ValNameList`.

A complete per-module logging threshold section is illustrated in **bold** in the following example:

```
<!-- ===== --><!--
Configure the Log Level -->
. . .
<CompoundList xmlns="http://www.oblix.com" ListName="LOG_CONFIG">

<!-- Write all FATAL logs to the system logger. -->
<ValNameList xmlns="http://www.oblix.com" ListName="LogFatal2Sys">
  <NameValPair ParamName="LOG_LEVEL" Value="LOGLEVEL_FATAL">
    </NameValPair>
  <NameValPair ParamName="LOG_WRITER" Value="SysLogWriter">
    </NameValPair>
  <NameValPair ParamName="LOG_STATUS" Value="On">
    </NameValPair>
</ValNameList>
. . .
</CompoundList>
<!-- List of values that can be specified in the module config -->
<!-- -->
<!-- On - Uses loglevel set in the loglevel threshold -->
<!-- Off - No information is logged -->
<!-- LOGLEVEL_FATAL - serious error, possibly a program halt. -->
<!-- LOGLEVEL_ERROR - a transient or self-correcting problem. -->
<!-- LOGLEVEL_WARNING - a problem that does not cause an error. -->
<!-- LOGLEVEL_INFO - reports the current state of the component. -->
<!-- LOGLEVEL_DEBUG1 - basic debugging information. -->
<!-- LOGLEVEL_DEBUG2 - advanced debugging information. -->
<!-- LOGLEVEL_DEBUG3 - logs performance-sensitive code. -->
<!-- LOGLEVEL_TRACE - used when you need to trace the code path -->
<!-- execution or capture metrics. Includes all previous levels. -->
<!-- -->
<!-- List of modules that can be specified in the module config -->
<!-- -->
<!-- ALL_MODULES - Applies to all log modules -->
<!-- Specific module name - Applies to specific module -->
<!-- -->
<!-- -->
<!-- <ValNameList -->
<!-- xmlns="http://www.oblix.com" -->
<!-- ListName="MODULE_CONFIG"> -->
<!-- <NameValPair -->
<!-- ParamName="CONNECTIVITY" -->
<!-- Value="LOGLEVEL_TRACE"></NameValPair> -->
<!-- </ValNameList> -->

  <ValNameList xmlns="http://www.oblix.com" ListName="MODULE_CONFIG">
    <NameValPair ParamName="LDAP" Value="LOGLEVEL_TRACE"></
NameValPair>
    <NameValPair ParamName="DB_RUNTIME" Value="LOGLEVEL_TRACE">
</NameValPair>
  </ValNameList>
```

```
</CompoundList>
```

9.8 Filtering Sensitive Attributes

You can activate secure logging and expand the default filter list to mask sensitive information from the log file.

When you add an attribute to the filter list, you must include the display name as well as the attribute name in the directory server. The following procedure describes how to perform this task. In this example, you are instructed to filter the user's home phone number: display name Home Phone; attribute name homePhone. However, you can filter the attribute of your choice.

Note:

Each value added to FILTER_LIST increases the runtime cost of using Secure Logging.

Oracle recommends that you optimize the use of FILTER_LIST to reduce the runtime cost. For example, rather than adding two ParamName variations (User Password and userPassword), you could use only one. Using Password as the ParamName masks values for User Password, userPassword, and other words that end with Password. Also, instead of including both Home Phone and homePhone in FILTER_LIST, you could simply use Phone.

See Also:

- ["Understanding Logging for WebGate instances"](#)
 - ["Parameters in the WebGate Simple List and Logging Threshold"](#)
 - ["Parameters in the WebGate Filter List"](#)
 - ["Settings in the Default Log Configuration File "](#)
-
-

1. Open the log configuration file in a text editor:

```
Webgate_install_dir\identity\access\oblix\config\oblog_config_wg.xml
```

2. In oblog_config_wg.xml:

- a. Confirm that secure logging is active. For example:

```
<SimpleList>
  <NameValPair
    ParamName="SECURE_LOGGING"
    Value="On"></NameValPair>
</SimpleList>
```

- b. Locate the FILTER_LIST parameter at the end of the file. For example:

```
<ValNameList xmlns="http://www.oblix.com" ListName="FILTER_LIST">
  <NameValPair ParamName="password" Value="40" />
  <NameValPair ParamName="Password" Value="40" />
  <NameValPair ParamName="response" Value="40" />
```



```
<NameValPair ParamName="Response" Value="40" />
</ValNameList>
```

- c. Add the display name to mask and the value for the mask length, then add the attribute and the value for the mask length. For example:

```
<NameValPair ParamName="Home Phone" Value="300" />
<NameValPair ParamName="homePhone" Value="300" />
```

Note:

For testing, set the LOG_THRESHOLD_LEVEL and LOG_SECURITY_THRESHOLD_LEVEL to TRACE. See Step 6a.

- d. Confirm that LOG_THRESHOLD_LEVEL and LOG_SECURITY_THRESHOLD_LEVEL are at the same level or are consistent with each other, as described in [Table 9-4](#). For example:

```
<SimpleList>
  <NameValPair ParamName="LOG_THRESHOLD_LEVEL" Value="LOGLEVEL_WARNING" />
</SimpleList>
...
<SimpleList>
  <NameValPair ParamName="LOG_SECURITY_THRESHOLD_LEVEL" Value="LOGLEVEL_
  WARNING" />
</SimpleList>
```

- e. Save the oblog_config_wg.xml file.

3. **Filtering User Password:** Perform the following steps and see "[Parameters in the WebGate Filter List](#)":

In the filter list in oblog_config_wg.xml, add the User Password display name and the corresponding attribute, and set the mask length for each. For example:

```
<ValNameList xmlns="http://www.oblix.com" ListName="FILTER_LIST">
  ...
  <NameValPair ParamName="User Password" Value="40" />
  <NameValPair ParamName="userPassword" Value="40" />
</ValNameList>
```

4. Test secure logging and filtering of sensitive information as follows:

- a. In the oblog_config_wg.xml file, set the LOG_THRESHOLD_LEVEL and LOG_SECURITY_THRESHOLD_LEVEL to TRACE:

```
<NameValPair ParamName="LOG_THRESHOLD_LEVEL" Value="LOGLEVEL_TRACE" />
...
<NameValPair ParamName="LOG_SECURITY_THRESHOLD_LEVEL" Value="LOGLEVEL_
TRACE" />
```

- b. Perform a task that involves the component for which you have configured secure logging. For example:

Access a resource

View or modify the value of the attribute in the user's profile: Home Phone (if the filtered attribute is homePhone).

- c. Check the oblog and confirm that the filtered attribute value is masked by a string like *****.

Webgate_install_dir/access/oblix/log/oblog.log

- d. In the oblog_config_wg.xml file, reset the LOG_THRESHOLD_LEVEL and LOG_SECURITY_THRESHOLD_LEVEL to the desired level for your enterprise.
- e. Adjust the mask length of filtered attributes if needed in the oblog_config_wg.xml file. For example:

```
<NameValPair ParamName="Home Phone" Value="340" />  
<NameValPair ParamName="homePhone" Value="340"/>
```

- 5. Repeat Steps 1 through 6 for each component in your deployment with one or more masked attributes.

Understanding Oracle Access Management Reports

Oracle Access Manager enables you to use Oracle BI Publisher as the reporting solution for Oracle Access Management services. Access Manager provides a restricted-use license for Oracle BI Publisher and easy-to-use reporting packages.

This chapter contains the following sections.

- [About Reports in Oracle Access Management](#)
- [Accessing Oracle Access Management Reports](#)
- [Supported Output Formats](#)
- [Classification of Reports for Access Manager](#)
- [About Creating Reports Using Third-Party Software](#)

Note:

For large-scale deployments, it is recommended that you deploy a dedicated enterprise-class reporting solution. A solution based on tools such as Oracle Business Intelligence Enterprise Edition can provide the flexibility, automation, and performance required for a large-scale organizations.

10.1 About Reports in Oracle Access Management

Oracle Access Management integrates with Oracle Business Intelligence Publisher, which provides a pre-defined set of compliance reports. The data in the database audit store is exposed through pre-defined reports in Oracle Business Intelligence Publisher. These reports allow you to drill down the audit data based on various criteria, such as user name, time range, application type, and execution context identifier (ECID).

Out-of-the-box, there are several sample audit reports available with Oracle Access Management and accessible with Oracle Business Intelligence Publisher. You can also use Oracle Business Intelligence Publisher to create your own custom reports.

Oracle BI Enterprise Edition (Oracle BI EE) is a comprehensive set of enterprise business intelligence tools and infrastructure, including a scalable and efficient query and analysis server, an ad-hoc query and analysis tool, interactive dashboards, proactive intelligence and alerts, real-time predictive intelligence, and an enterprise reporting engine. Oracle BI EE is designed to bring greater business visibility and insight to a wide variety of users.

The components of Oracle Business Intelligence Enterprise Edition share a common service-oriented architecture, data access services, analytic and calculation infrastructure, metadata management services, semantic business model, security

model and user preferences, and administration tools. Oracle Business Intelligence Enterprise Edition provides scalability and performance with data-source specific optimized analysis generation, optimized data access, advanced calculation, intelligent caching services, and clustering. The following are Oracle Access Management reporting features:

- Select and view reports from a predefined list in the BI Publisher.
- Filter report information.
- View reports on-screen in the desired format.
- Provide interactive reports.

10.2 Accessing Oracle Access Management Reports

To access Access Manager Reports, you must start BI Publisher and run them. BI Publisher cannot be accessed through the Access Manager Console. You must open BI publisher explicitly to access Access Manager reports.

Follow this procedure to start BI Publisher.

1. Navigate to **Start, Oracle BI Publisher Desktop, Oracle - BIPHome10134** and click **Start BI Publisher**.

The Oracle BI Publisher Home page appears.

2. Enter the user name and password.
3. Click Sign In.

Follow this procedure to run a report.

1. Start Access Manager Reports.

See "[Accessing Oracle Access Management Reports](#)" for more information.

2. Click the more... link under Shared Folders.
3. Click Access Manager Reports to access the reports.

Alternately, click the more... link under Access Manager Reports. The resulting page displays the Access Manager Reports classified according to functional area.

4. Select the report to view by clicking its name.
5. Click View.

The Report Input Parameters page displays the input parameters that must be provided to run a report. The parameters act as filter criteria. In some cases, at least one or more fields are mandatory while some reports do not require any input parameters. If you leave the input parameter field blank and click View, all the information associated with the report is displayed.

6. Enter the required parameters, if any.
7. Click View to run the report.

The report is displayed.

10.3 Supported Output Formats

All BI Publisher reports are generated in a native XML format. This XML can be transformed into other output formats.

The following formats are supported:

- HTML
- PDF
- RTF
- MHTML

10.4 Classification of Reports for Access Manager

Access Manager Reports are classified based on functional area.

For example, Access Policy Reports, Attestation, Request and Approval Reports and Password Policy Reports are available. (It is no longer named Operational and Historical.) Oracle Access Manager Reports are classified into the following categories based on their functional areas:

- [Account Management Reports](#)
- [Authentication Reports](#)
- [Errors and Exceptions](#)

10.4.1 Account Management Reports

The Accounts_Locked_Out Report is the account management report that allows administrators to view details about accounts that have been locked out.

Table 10-1 Accounts_Locked_Out Report Fields

Field	Description
User ID	Identifier of the locked out user
Timestamp	Time stamp of the lockout
Component/Application Name	Component from which the user has been locked out
Event Details	Additional information

10.4.2 Authentication Reports

Authentication reports allow administrators to view details regarding user authentications.

The reports include:

- [Authentication Statistics Report](#)
- [AuthenticationFromIPByUser](#)
- [AuthenticationPerIP](#)

- [AuthenticationStatisticsPerServer Report](#)

10.4.2.1 Authentication Statistics Report

The authentication report contains details regarding failed and successful authentications.

Table 10-2 Authentication_statistics Report Fields

Field	Description
Failure	Failed (yes) or successful (no) authentication
Userid	Identifier of the user
Number of Events	Number of authentication events

10.4.2.2 AuthenticationFromIPByUser

The AuthenticationFromIPByUser report contains details regarding failed and successful authentications from a particular IP address.

Table 10-3 AuthenticationFromIPByUser Report Fields

Field	Description
IP Address	IP address of the client
Distinct User Count	Number of distinct users
Total Attempts	Number of authentication attempts from this IP address
Users	List of users attempting authentication from this IP address

10.4.2.3 AuthenticationPerIP

The AuthenticationPerIP report contains details regarding failed and successful authentications from this IP address.

Table 10-4 AuthenticationPerIP Report Fields

Field	Description
IP Address	IP address of the server
Distinct Users	Number of users authenticated
Total Number of Attempts	Number of authentication attempts (successful and failed)

10.4.2.4 AuthenticationStatisticsPerServer Report

The AuthenticationStatisticsPerServer report contains details regarding failed and successful authentications from a particular server instance.

Table 10-5 AuthenticationStatisticsPerServer Report Fields

Field	Description
Server Instance Name	Identifier of the server instance
Success Count	Number of successful authentications
Failure Count	Number of failed authentications

10.4.3 Errors and Exceptions

The errors and exceptions report allows administrators to view errors and exceptions logged during the authentication process.

This report include:

- [All Errors and Exceptions](#)
- [Authentication Failures](#)
- [User Activities](#)
- [Authentication History](#)
- [Authorization History](#)
- [Multiple Logins From Same IP](#)

10.4.3.1 All Errors and Exceptions

All Errors and Exceptions report contains details regarding errors and exceptions encountered during runtime.

Table 10-6 All Errors and Exceptions Report Fields

Field	Description
User ID	Identifier of the locked out user
Timestamp	Time stamp of the lockout
Component/Application Name	Component from which the user has been locked out
Client IP Address	IP address of the client
Message Event	The error or exception
Event Details	Information regarding the error or exception

10.4.3.2 Authentication Failures

The Authentication Failures report contains details regarding failed and successful authentications.

Table 10-7 Authentication Failures Report Fields

Field	Description
User ID	Identifier of the locked out user
Timestamp	Time stamp of the lockout
Component/Application Name	Component from which the user has been locked out
Client IP Address	IP address of the client
Authentication Method	Authentication method
Message Event Details	Message regarding the failed authentication
Authorization_Failures	Authorization failure

10.4.3.3 User Activities

There are no fields to define in the User Activities report.

10.4.3.4 Authentication History

The Authentication History report contains details regarding failed and successful authentications.

Table 10-8 Authentication History Report Fields

Field	Description
User ID	Identifier of the locked out user
Timestamp	Time stamp of the lockout
Component/Application Name	Component from which the user has been locked out
Client IP Address	IP address of the client
Authentication Method	Authentication method
Message Event Details	Message regarding the failed authentication
Authorization_Failures	Authorization failure

10.4.3.5 Authorization History

The Authorization History report contains details regarding failed and successful authorizations.

Table 10-9 Authorization History Report Fields

Field	Description
User ID	Identifier of the locked out user
Timestamp	Time stamp of the lockout
Component/Application Name	Component from which the user has been locked out

Table 10-9 (Cont.) Authorization History Report Fields

Field	Description
Client IP Address	IP address of the client
Authentication Method	Authentication method
Message Event Details	Message regarding the failed authentication
Authorization_Failures	Authorization failure

10.4.3.6 Multiple Logins From Same IP

The Multiple Logins From Same IP report contains details regarding multiple logins from the same IP address.

Table 10-10 Multiple Logins From Same IP Report Fields

Field	Description
IP Address	IP address
Username Used	Identifiers of users

10.5 About Creating Reports Using Third-Party Software

Access Manager supports the creation of reports by using third-party tools such as Crystal Reports.

To learn how to create reports by using third-party software, see the third-party software documentation. Additional information on the audit schema and creating custom reports can be found in the *Securing Applications with Oracle Platform Security Services*.

Monitoring Oracle Access Management Performance and Access Manager Health

Monitoring performance refers to observing (viewing) performance metrics to make yourself aware of the state of specific components of Oracle Access Management. Monitoring health allows perimeter devices to check the health of an Access Manager server instance by hitting the heartbeat URL of the Managed Server.

This chapter contains the following sections on monitoring Oracle Access Management performance and Access Manager health.

- [Introduction to Performance Monitoring](#)
- [Monitoring Server Metrics Using Oracle Access Management Console](#)
- [Monitoring SSO Agent Metrics Using Oracle Access Management Console](#)
- [OAM Proxy Metrics and Tuning](#)
- [Monitoring Metrics Using the DMS Console](#)
- [Monitoring the Health of an Access Manager Server](#)

See Also:

- [Monitoring Performance and Logs with Fusion Middleware Control](#) if you are using Oracle Enterprise Manager Fusion Middleware Control
-

11.1 Introduction to Performance Monitoring

Component performance metrics can be collected in memory during the completion of particular events. These metrics are kept only in memory so there are several mechanisms to extract and display them including (but not limited to) Oracle Enterprise Manager Fusion Middleware Control (FMW), the Oracle Dynamic Monitoring Service (DMS) and the Oracle Process Manager and Notification Server (OPMN).

- FMW Control is a Web browser-based, graphical user interface that offers monitoring options. See [Monitoring Performance and Logs with Fusion Middleware Control](#) for details.
- DMS uses the DMS Spy Servlet to provide access to DMS metric data from a web browser. Information is categorized by Noun Types; for Oracle Access Management the prefix is OAMS.OAM_. See [Monitoring Metrics Using the DMS Console](#).

- dmsdump is provided by DMS to take metrics from the servers based on definitions in a dms configuration file. There are many OAM metrics exposed when dms dumps are generated. See the *Oracle Fusion Middleware Performance and Tuning Guide* for more details.
- OPMN provides access to metrics using dmsdump. See the *Oracle Fusion Middleware Performance and Tuning Guide* for more details.

11.2 Monitoring Server Metrics Using Oracle Access Management Console

Users with valid Oracle Access Management Administrator credentials can log into the Oracle Access Management Console and monitor various performance metrics.

This section provides the following topics:

- [Monitoring Server Instance Performance](#)
- [Oracle Access Manager Server Metrics](#)

11.2.1 Monitoring Server Instance Performance

Users with valid Oracle Access Management Administrator credentials can monitor performance for Access Manager using the Monitoring command on the Actions menu under the System Configuration tab using the Oracle Access Management Console.

See [Understanding the Oracle Access Management Console](#) for details.

Before you begin, the OAM Server must be running.

1. From the Oracle Access Management Console, click Server Instances and the desired server instance.
2. **Server Instance:**
 - a. From the **Actions** menu in the navigation tree, click **Monitor Menu**.
 - b. On the Monitor page, click the desired subtab to view results for the server instance:
 - Server Processes Overview
 - Session Operations
 - Server Operations
 - WebGates
 - c. Proceed to [Oracle Access Manager Server Metrics](#)
3. See also, "[OAM Proxy Metrics and Tuning](#)".

11.2.2 Oracle Access Manager Server Metrics

This topic provides a look at the Server metrics available through the **Monitor** option from the **Server Instances** tab in the **Configuration** section of the console.

[Figure 11-1](#) shows the Server Processes page.

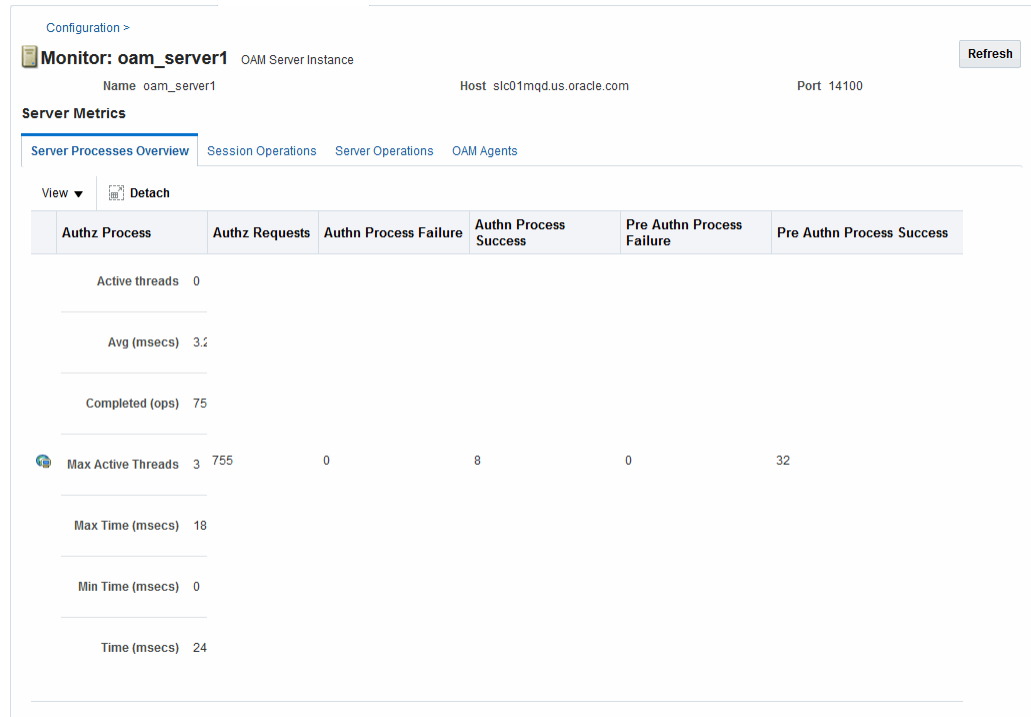
Figure 11-1 Server Processes Overview Page

Server Processes Overview provides the following OAM Server events, organized in individual columns on the tab.

The following are the server metric columns in the Server Process Overview Tab:

- Authorization Process
- Authorization Requests
- Authentication Process Failure
- Authentication Process Success
- Pre Authentication Process Failure
- Pre Authentication Process Success

Figure 11-2 shows the Session Operations tab.

Figure 11-2 OAM Server Metrics: Session Operations Monitoring Page

Server Processes Overview **Session Operations** Server Operations OAM Agents

View  Detach

	Check Session Valid	Create Session	Destroy Session	Delete Client Session
Active threads	0	Active threads 0	Active threads 0	Active threads 0
Avg (msecs)	1.044	Avg (msecs) 560.0	Avg (msecs) 0.0	Avg (msecs) 0.0
Completed (ops)	1617	Completed (ops) 10	Completed (ops) 0	Completed (ops) 0
 Max Active Threads	5	Max Active Threads 1	Max Active Threads 0	Max Active Threads 0
Max Time (msecs)	195	Max Time (msecs) 1405	Max Time (msecs) 0	Max Time (msecs) 0
Min Time (msecs)	0	Min Time (msecs) 17	Min Time (msecs) 0	Min Time (msecs) 0
Time (msecs)	1689	Time (msecs) 5600	Time (msecs) 0	Time (msecs) 0

Columns Hidden 8

OAM Server Session Operations metrics include:

- Check Session Valid
- Check Session Valid Failure
- Check Session Valid Success
- Create Session
- Create Session Failure
- Create Session Success
- Destroy Session
- Destroy Session Failure
- Destroy Session Success
- Delete Client Session
- Delete Client Session Failure

Figure 11-3 shows the Server Operations tab.

Figure 11-3 OAM Server Metrics: Server Operations Tab

Server Processes Overview Session Operations **Server Operations** OAM Agents

View ▾ Detach

Auth Policy Response Success	Auth Scheme Response Success	Authn Policy Response	Authz	Is Resource Protected
		Active threads 0	Active threads 0	Active threads 0
		Avg (msecs) 0.07644882860665844	Avg (msecs) 3.2386363636	Avg (msecs) 0.951073985
		Completed (ops) 811	Completed (ops) 792	Completed (ops) 838
811	811	Max Active Threads 2	Max Active Threads 3	Max Active Threads 2
		Max Time (msecs) 9	Max Time (msecs) 183	Max Time (msecs) 202
		Min Time (msecs) 0	Min Time (msecs) 0	Min Time (msecs) 0
		Time (msecs) 62	Time (msecs) 2565	Time (msecs) 797

Columns Hidden 11

The following are the OAM Server Operations metrics in the Server Operations Tab:

- Authentication Policy Response Failure
- Authentication Policy Response Success
- Authentication Scheme Response Failure
- Authentication Scheme Response Success
- Authentication Failure
- Authentication Failure Responses
- Authentication Policy Response
- Authentication Requests
- Authentication Scheme Response
- Authorization Failure
- Authorization Failure
- Authorization Process Failure
- Authorization Process Success

Figure 11-4 shows the OAM Server Metrics: WebGates tab with all available metrics showing.

Figure 11-4 OAM Server Metrics: WebGates Tab

Agent Name	Agent Status	Version
 Agent_IAMSuiteAgent	Connected	10.x

WebGate performance metrics include:

- Agent Name
- Agent Status
- Version

11.3 Monitoring SSO Agent Metrics Using Oracle Access Management Console

This section describes how to review metrics for various components and how to determine whether tuning is needed. Users with valid Oracle Access Management Administrator credentials can use the following procedure to display various SSO Agent performance metrics using the Oracle Access Management Console.

Before you begin, the server and agent must be running.

1. In the Oracle Access Management Console, click **Application Security** at the top of the window.
2. In the Application Security console, click **Agents**.
3. In the Search SSO Agents page, select the desired agent type tab:
 - WebGates
 - OSSO Agents
 - OpenSSO Agents

This Agent can only be monitored using OpenSSO Proxy behavior with respect to Agent Requests. See [Monitoring OpenSSO Proxy Metrics](#).
4. Search for the agent you want to monitor.
5. In the Search Results table, highlight the desired agent SerialNumber and from the **Actions** menu select **Monitor**.
6. Proceed as needed.
 - [WebGate Metrics](#)
 - [OSSO Agent Metrics](#)

11.3.1 WebGate Metrics

WebGate metrics are organized across various tabs.

The tabs are:

- Connectivity
- Operations Overview
- Operations Detail
- Information

See Also:

Tuning Performance

Following figures illustrate detached tables for one Webgate with all possible metrics displayed for each:

- [Figure 11-5](#)
- [Figure 11-6](#)
- [Figure 11-7](#)
- [Figure 11-8](#)

Figure 11-5 Webgate Metrics: Connectivity Table

Connectivity						
Operations Overview Operations Detail Information						
View ▾ Detach						
OAM Server Name	Agent Host Name	Agent IP	Active Connections	Terminated Connections	Last Operation Time	
slc01mqd.us.oracle.com		127.0.0.1	21	45928	12/12/2014 11:23 AM	

Figure 11-6 Webgate Metrics: Operations Overview Table

Connectivity Operations Overview Operations Detail Information						
View ▾ Detach						
OAM Server Name	Agent Host Name	Operations/Sec	Average Operation Latency (ms)	Min Operation Latency (ms)	Max Operation Latency (ms)	
slc01mqd.us.oracle.com		Not Available	0.57	0	680	

Figure 11-7 Webgate Metrics: Operations Detail Table

Connectivity Operations Overview Operations Detail Information						
View ▾ Detach						
OAM Server Name	Agent Host Name	Handshake Success Rate	Token Validation Success Rate	Authorization Success Rate	Authentication Success Rate	
slc01mqd.us.oracle.com		100.0%	99.4%	99.88%	Not Available	

Figure 11-8 Webgate Metrics: Detached Information Table

OAM Server Name	Agent Host Name	Agent Version	Agent Type	Agent Start Time	Agent OS	Agent Server Type	Agent Server Information	Agent Install directory	Agent Instance Directory
slc01mqd.u...		10.x	Not Avail...		Not Avail...	Not Available	Not Available	Not Available	Not Available

11.3.2 OSSO Agent Metrics

When you have an OSSO Agent selected OSSO Agents Search Results table and have chosen Monitor from the table's Actions menu, you can view the metrics pages.

Following are the metrics pages available:

- [Figure 11-10](#)
- [Figure 11-11](#)

Figure 11-9 OSSO Agent Monitoring Page with Operation Details

Name	Host	Server Name	Check Session Valid	Is Resource Protected	Validate Credentials
			Active threads	Active threads	Active threads
			Avg (msecs)	Avg (msecs)	Avg (msecs)
			Completed (ops)	Completed (ops)	Completed (ops)
			Max Active Threads	Max Active Threads	Max Active Threads
			Max Time (msecs)	Max Time (msecs)	Max Time (msecs)
			Min Time (msecs)	Min Time (msecs)	Min Time (msecs)
			Time (msecs)	Time (msecs)	Time (msecs)

[Figure 11-10](#) illustrates the OSSO Agent Monitoring Process Overview table.

Figure 11-10 OSSO Agent Monitoring Process Overview Table

Processes Overview		Operation Details					
Name	Host	Process	Authentication Process	Pre Authentication Process	Pre Authentication Process Success	Pre Authentication Requests	Authentication Requests
			Active threads	Active threads			
			Avg (msecs)	Avg (msecs)			
			Completed (ops)	Completed (ops)			
			Max Active Threads	Max Active Threads			
			Max Time (msecs)	Max Time (msecs)			
			Min Time (msecs)	Min Time (msecs)			
			Time (msecs)	Time (msecs)			

Figure 11-11 illustrates the OSSO Agent Operation Details table.

Figure 11-11 OSSO Agent Operation Details Table

Processes Overview		Operation Details			
Name	Host	Server Name	Check Session Valid	Is Resource Protected	Validate Credentials
			Active threads	Active threads	Active threads
			Avg (msecs)	Avg (msecs)	Avg (msecs)
			Completed (ops)	Completed (ops)	Completed (ops)
			Max Active Threads	Max Active Threads	Max Active Threads
			Max Time (msecs)	Max Time (msecs)	Max Time (msecs)
			Min Time (msecs)	Min Time (msecs)	Min Time (msecs)
			Time (msecs)	Time (msecs)	Time (msecs)

11.4 OAM Proxy Metrics and Tuning

This section provides the following topics:

- [OAM Proxy Metrics](#)
- [OAM Proxy Server Tuning Parameters](#)

See Also:

- ["OpenSSO Proxy Events and Metrics: Server "](#)
 - *Tuning Performance*
-

11.4.1 OAM Proxy Metrics

Throughput refers to the number of requests processed per second. Latency refers to the time required to process a particular request. There is less than a 20% latency increase with the introduction of a proxy between WebGate and OAM Server.

[Table 11-1](#) lists the various OAM Proxy metrics available.

Table 11-1 OAM Proxy Metrics

Metric	Description
handshakes.active	Number of active threads doing handshake
handshakes.avg	Average time spent performing initial handshake
handshakes.completed	Number of times an initial handshake has been executed
handshakes.maxTime	Maximum time spent performing initial handshake
handshakes.minTime	Minimum time spent performing initial handshake
handshakes.time	Total time spent performing initial handshake
failedHandshakes.count	Count of failed handshakes
peerCompatibilityFailures.count	Count of how many Peer Compatibility Check Failures have happened
openSecurityMode.count	Count of how many Open Security Mode handshakes have happened
simpleSecurityMode.count	Count of how many Simple Security mode handshakes have happened
SSLSecurityMode.count	Count of how many SSL Security Mode handshakes have happened
negotiateSecurityMode.active	Number of active threads doing security mode negotiation

11.4.2 OAM Proxy Server Tuning Parameters

Performance of the OAM Proxy can be tuned by changing its configuration through the Java EE container Administration Console.

Both the Java EE container Administrator and the Oracle Access Management Administrator can tune performance using the Java EE container Administration Console, which is outside the scope of this book.

[Table 11-2](#) provides the tuning parameters for the OAM Proxy.

Table 11-2 OAM Proxy Tuning Parameters

Purpose	Parameter	Type	Value	Description
Denial of Service Attacks	ConnectionValidationInterval	Integer	120	The time interval in seconds for validating the connections periodically for denial of service attacks
Denial of Service Attacks	BacklogQueue	Integer	50	Maximum length of backlog queue
Denial of Service Attacks	MaxNAPHandShakeTime	Integer	100	The maximum time in milliseconds within which the client should complete the NAP handshake with client. If NAP handshake over a connection is not completed within this time, the connection will be marked as malicious

11.5 Monitoring Metrics Using the DMS Console

Oracle Access Management uses the Oracle Dynamic Monitoring Systems (DMS) to measure application-specific performance information for OAM Servers and registered Agents. The metrics can be used to monitor the time spent in a particular area, or track particular occurrences or state changes.

To access the DMS console, type the following URL in a browser window and log in with your Oracle Access Management Administrator credentials.

```
http:// <example_AdminServer:Port>/dms/Spy
```

Once logged into the DMS console you can monitor metrics as discussed in the following sections.

- [Monitoring OAM Metrics](#)
- [Monitoring Coherence Caches](#)
- [Monitoring OpenSSO Proxy Metrics](#)

11.5.1 Monitoring OAM Metrics

The OAM metrics can be reviewed in the DMS Metric Tables panel.

You can access metrics regarding OAM as illustrated in [Figure 11-12](#). Click the desired metric from those listed to view the results on the right-side of the console.

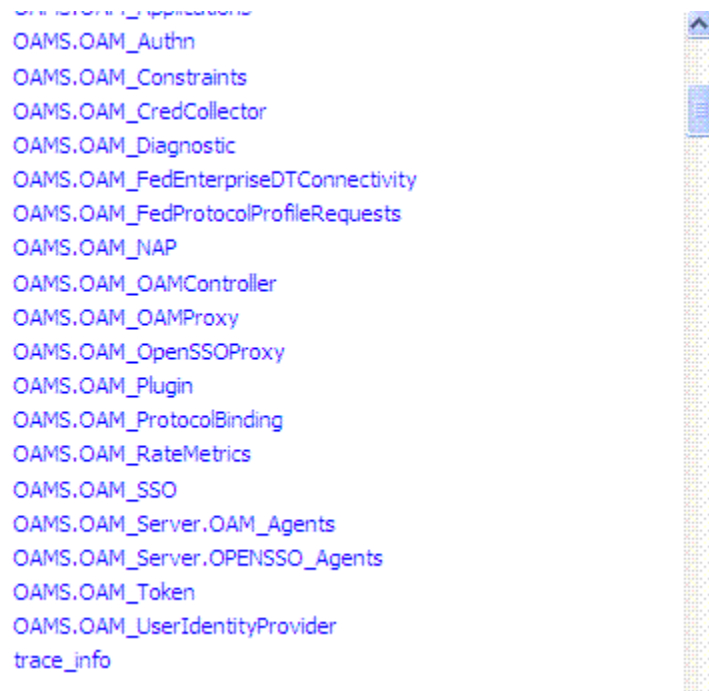
Figure 11-12 OAM Metrics Table

OAMS.OAM_Authn
OAMS.OAM_Constraints
OAMS.OAM_CredCollector
OAMS.OAM_Diagnostic
OAMS.OAM_FedEnterpriseDTConnectivity
OAMS.OAM_FedProtocolProfileRequests
OAMS.OAM_NAP
OAMS.OAM_OAMController
OAMS.OAM_OAMProxy
OAMS.OAM_OpenSSOProxy
OAMS.OAM_Plugin
OAMS.OAM_ProtocolBinding
OAMS.OAM_RateMetrics
OAMS.OAM_SSO
OAMS.OAM_Server.OAM_Agents
OAMS.OAM_Server.OPENSSEO_Agents
OAMS.OAM_Token
OAMS.OAM_UserIdentityProvider
trace_info

11.5.2 Monitoring Coherence Caches

You can access information regarding the Coherence caches used in OAM. OAM uses Coherence as a distributed cache to perform various functions. Coherence provides management and monitoring support through management mbeans. Beginning with this 11.1.2.2.3 release, OAM exposes Coherence metrics as DMS metrics. Thus, monitoring information can be accessed using the DMS console.

In the DMS Metric Tables panel, the Coherence metrics for each of the caches is available for review under the Weblogic Metrics section as illustrated in [Figure 11-13](#). The metric table links in the section provide details about the cache operations.

Figure 11-13 Weblogic Metrics

OAMS.OAM_AgentSessionCacheRuntime
OAMS.OAM_CacheService
OAMS.OAM_ConsentCacheRuntime
OAMS.OAM_DeviceCacheRuntime
OAMS.OAM_DistributorCacheRuntime
OAMS.OAM_ExtensibilityCacheRuntime
OAMS.OAM_JournalCacheRuntime
OAMS.OAM_MetricsCacheRuntime
OAMS.OAM_STSCacheRuntime
OAMS.OAM_SessionCacheRuntime
OAMS.OAM_SessionCounts
OAMS.OAM_TokenCacheRuntime

11.5.3 Monitoring OpenSSO Proxy Metrics

This section provides the following topics:

- [Reviewing OpenSSO Metrics](#)
- [OpenSSO Proxy Events and Metrics: Server](#)
- [OpenSSO Proxy Metrics: Agent](#)

11.5.3.1 Reviewing OpenSSO Metrics

User with valid Oracle Access Management Administrator credentials can view OpenSSO Proxy metrics in the DMS console.

Before you begin the procedure to access the DMS console, the OAM Server must be running.

1. In a browser window, go to the DMS Console using the following URL:

```
http://<example_AdminServer:Port>/dms/Spy
```

2. Log in with your Oracle Access Management Administrator credentials.
3. OpenSSO Agent Metrics: In the DMS Metric Tables, click OAMS.OAM_Server.OPENSSEO_Agents.
4. OpenSSO Proxy Metrics: In the DMS Metric Tables, click OAMS.OAM_OpenSSOProxy and view the results on the right side of the console.

11.5.3.2 OpenSSO Proxy Events and Metrics: Server

Throughput refers to the number of requests processed per second. Latency refers to the time required to process a particular request.

The Events that can be monitored are described in [Table 11-3](#).

Table 11-3 OpenSSO Proxy Server Events

Event	Description
Naming Service Request	This request is for naming lookups. One can monitor response time taken by the OpenSSO Proxy in servicing this request
Agent Authentication Process	Agent Authentication has been captured in two phases: <ul style="list-style-type: none"> • AgentAuthentication_Login and AgentAuthentication_SubmitRequirements phase. The second phase refers to the phase after the credentials are submitted by the OpenSSO Agent for authentication • The second phase refers to the phase after the credentials are submitted by the OpenSSO Agent for authentication.
Agent Session Validation	Agent Session Validation
User Authentication	This event is captured for Client SDK's only. One can monitor response time taken to authenticate client SDK's through this diagnostic event
User Session Validation	Time taken to validate User Session

Table 11-3 (Cont.) OpenSSO Proxy Server Events

Event	Description
User Authorization	Time taken for authorization as per the configured policy for the given resource

[Table 11-4](#) lists the various OpenSSO Proxy metrics available for the named server.

Table 11-4 OpenSSO Proxy Metrics: Server

Metric	Description
AgentAuthentication_Login	Response time details for Authentication requests during login phase sent by the Agent to authenticate
AgentAuthentication_LoginFailures	Count of how many Agent Authentication requests during login phase have failed.
AgentAuthentication_SubmitRequirements	Response time details for Authentication requests during Submit Requirements phase send by the Agent to authenticate
AgentAuthentication_SubmitRequirementsFailures	Count of how many Agent Authentication requests during Submit Requirements phase have failed
NamingServiceRequest	Response time details for Naming Service Request operations
NamingServiceRequestFailures	Count of how many Naming Service Request operations have failed
UserAuthentication_SDK	Response time details for User Authentication requests
UserAuthentication_SDKFailures	Count of how many User authentication Requests have failed
UserAuthorization	Response time details for User Authorization operations
UserAuthorizationFailures	Count of how many user authorization operations have failed
ValidateAgentSession	Response time details for Agent Session Validation operation
ValidateAgentSessionFailures	Count of how many agent session validation operations have failed
ValidateUserSession	Response time details for User Session Validation operation
ValidateUserSessionFailures	Count of how many User session validation operations have failed.

11.5.3.3 OpenSSO Proxy Metrics: Agent

OpenSSO Proxy metrics are available for each OpenSSO Agent.

[Table 11-5](#) lists the OpenSSO Proxy metrics.

Table 11-5 OpenSSO Proxy Metrics: Agent

Metric	Description
AgentAuthentication_SubmitRequirements	Response time details for Authentication requests during Submit Requirements phase collected per Agent

Table 11-5 (Cont.) OpenSSO Proxy Metrics: Agent

Metric	Description
AgentCacheMode	Specifies the cache mode for the client policy evaluator. Values can be: subtree or self
AgentFilterMode	Specifies how the agent filters requests to protected web applications. The global value functions as a default, and applies for protected applications that do not have their own filter settings
AgentHostName	The host name of OpenSSO Agent
AgentIPAddress	The IP Address of OpenSSO Agent
AgentMappingMode	Specifies the mechanism used to determine the user ID
AgentState	The state of OpenSSO Agent: enabled or disabled.
UserAttributeName	Specifies the data store attribute that contains the user ID
UserAuthorization	Response time details for User Authorization operations collected per Agent
UserIdentity	Specifies the session property name for the authenticated user's ID. Default is 'UserToken'
ValidateAgentSession	Response time details for Agent Session Validation operation collected per Agent
agentType	The type of OpenSSO agent: J2EE or Web Agent

11.6 Monitoring the Health of an Access Manager Server

Access Manager Services are business critical and must always be available to control user access to an organization's protected web services and applications. Because hardware, network connectivity issues and other failures can happen, HeartBeat monitoring can be leveraged by Load Balancers to ensure user traffic is routed to healthy OAM Servers.

For example, when there is a firewall installed between a User Agent or WebGate (10 or 11g) and the 10g or 11g Access Manager server, perimeter devices can check availability of the Access Manager server (its *health*) by hitting its HeartBeat URL. The following sections contain details.

- [Understanding WebGate and Access Manager Communications](#)
- [Monitoring Access Manager Server Health](#)

11.6.1 Understanding WebGate and Access Manager Communications

When deploying a network firewall between a WebGate and Access Manager server, the WebGate communicates using the OAP protocol by creating a TCP socket connection with Access Manager to establish a message channel. The WebGate uses the message channel to send different OAP messages necessary to serve the resource requests (isprotected, isauthorized, and the like). Now, consider a situation in which the WebGate/Oracle HTTP Server is idle. In this case, the WebGate has received no

resource request and will not send any messages to Access Manager for authentication or authorization; there will also not be any read/write activity on the socket connection.

The firewall determines this connection is *idle* after 30-40 minutes of inactivity (depending on its configuration) and terminates the socket connection but does not inform/notify the WebGate or Access Manager server. In this case, when a request for a resource arrives at the WebGate and it sends a OAP message to the Access Manager server, it uses the existing connection and waits for a reply. Because the connection was dropped by the firewall, the WebGate does not receive any reply; so it waits for the TCP timeout. Following the TCP timeout, WebGate understands the message channel is of no use and starts the process to get a new message channel. TCP timeout is OS specific and may vary from several minutes to hours which makes the WebGate unable to process user requests.

Note:

The `setKeepAlive` WebGate parameter ensures that load balancers do not drop the OAP connection. See [Table 15-2](#) for details.

11.6.2 Monitoring Access Manager Server Health

The OAM monitoring model allows Web Tier components (load balancers) to ping an OAM Managed Server's HeartBeat endpoint at a scheduled interval over HTTP(S). This allows Web Tier components to route incoming HTTP traffic away from unhealthy OAM Managed Server(s).

Every OAM Managed Server exposes this HeartBeat URL:

`Scheme://ManagedServerHost:ManagedServerPort/oam/server/HeartBeat`

In this URL, the following is true:

- `scheme = https | http`
- `ManagedServerHost` = Host name of the Access Manager WLS Managed Server
- `ManagedServerPort` = Port used by the Access Manager WLS Managed Server

The HeartBeat URL works as follows:

1. The Web Tier components will send an HTTP request to the HeartBeat endpoint of the Access Manager Managed Server.
2. The Access Manager Managed Server will then do the following:
 - Verify Id Store Connectivity
 - Verify Policy Store Connectivity
 - Verify the Credential Collector URLs are reachable
 - Sanity check the working of the Coherence Layer
 - Check for NAP connectivity

If the above tests succeed, the Access Manager server is considered to be healthy and a HTTP 200 response is sent to the Load Balancer. Any other HTTP Status Code value signifies that the Access Manager Managed Server is not healthy.

3. When multiple Access Manager Managed Servers are present in the deployment, the Web Tier component will repeat this for each OAM Managed Server.

Note:

Neither the health status test results or check results can be communicated in the body of the HTTP Response. A successful heartbeat check will return the HTTP code 200.

Monitoring Performance and Logs with Fusion Middleware Control

Live, dynamic performance metrics can be viewed in Fusion Middleware Control.

You can monitor performance and log messages for Access Manager and Security Token Service using Oracle Fusion Middleware Control. This chapter focuses on general tasks that Administrators can perform from Fusion Middleware Control, which does not replace details in Overview of Oracle Fusion Middleware Administration Tools in *Administering Oracle Fusion Middleware*.

Note:

Unless explicitly stated, information in this chapter is the same for both services. There are no metrics in Oracle Fusion Middleware Control for Identity Federation or Mobile and Social.

This chapter includes the following topics.

- [Introduction to Fusion Middleware Control](#)
- [Logging In to and Out of Fusion Middleware Control](#)
- [Displaying Menus and Pages in Fusion Middleware Control](#)
- [Viewing Performance in Fusion Middleware Control](#)
- [Managing Log Level Changes in Fusion Middleware Control](#)
- [Managing Log File Configuration from Fusion Middleware Control](#)
- [Viewing Log Messages in Fusion Middleware Control](#)
- [Displaying MBeans in Fusion Middleware Control](#)

12.1 Introduction to Fusion Middleware Control

Within Fusion Middleware Control, information is updated dynamically during live sessions of Access Manager, Security Token Service, and other products. Fusion Middleware Control organizes a wide variety of performance data and administrative functions into distinct Web-based pages. This helps Administrators easily locate the most important monitoring data and the most commonly used administrative functions from a Web browser.

Note:

Enterprise Manager Grid Control is an independently licensed product that provides additional capabilities not found in Fusion Middleware Control (primarily, the ability to collect and maintain data for historical purposes and trending).

Oracle Access Management 11g is deployed as a Java EE application in a WebLogic container. For high availability and failover, Oracle Access Management is typically deployed in a WebLogic cluster environment.

A WebLogic Server domain can have multiple clusters. To provide monitoring and performance statistics for all clustered components requires a composite target. This target provides status and rolled-up load and response performance metrics for member instances. In addition to the metrics exposed for Access Manager and Security Token Service, generic performance metrics are also available for Java EE application and composite Java EE applications.

Fusion Middleware Control must be deployed with Oracle Access Management on the WebLogic Administration Server, as illustrated in [Figure 12-1](#) (and described in the *Oracle Fusion Middleware Installation Guide for Oracle Identity and Access Management*).

Figure 12-1 Fusion Middleware Control (AS-Control) Deployment Architecture

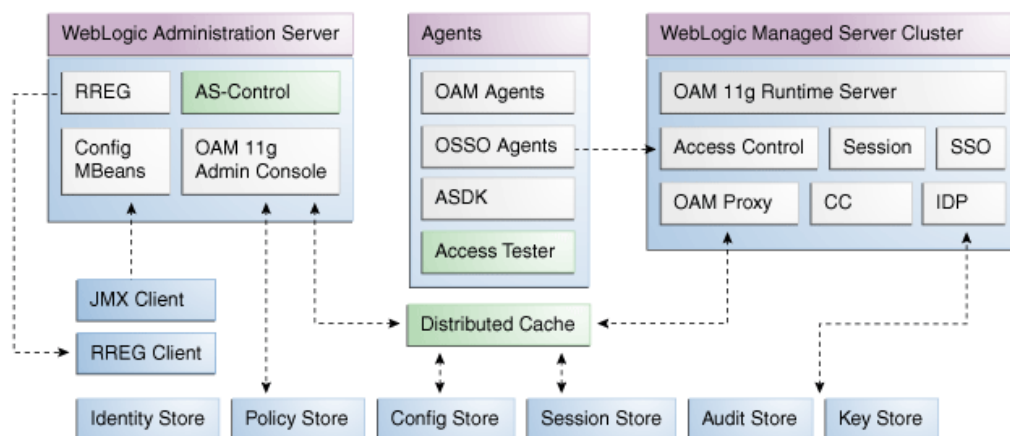

Using Fusion Middleware Control for targets is supported through the Oracle Dynamic Monitoring Systems instrumentation within Oracle Access Management. This instrumentation is used to provide:

- Performance overview and drill down
- Log message searches and dynamic log level changes
- Routing topology overview
- Mbean browser
- Component- and cluster-level metrics for Access Manager with Security Token Service

12.2 Logging In to and Out of Fusion Middleware Control

The Fusion Middleware Control Login page provides the usual fields for the User Name and Password.

The bottom of the Fusion Middleware Control Login page provides topics that you can click for additional information. This section provides the following topics:

- [Logging In To Fusion Middleware Control](#)
- [Logging Out of Fusion Middleware Control](#)

12.2.1 Logging In To Fusion Middleware Control

Only Fusion Middleware Control Administrators log in to Fusion Middleware Control.

See Also:

Oracle Fusion Middleware Administrator's Guide for details about getting started using Fusion Middleware Control

1. In a browser window, enter the URL to Fusion Middleware Control. For example:

`http://host.example.com:8888/em/`

2. Expand a topic at the bottom of the Login page to learn about the enhanced user experience or new features.
3. Log in as a Fusion Middleware Control Administrator.
4. Choose the farm containing Oracle Access Management, if needed.
5. Help: From the Farm Resource Center on the OAM Farm page, choose topics of interest (or click Help in the upper-right corner of the page) to get more information.
6. Proceed to any topic in this chapter for viewing and configuration details.

12.2.2 Logging Out of Fusion Middleware Control

You can log out of Fusion Middleware Control.

1. Click the Log Out link in the upper-right corner of Fusion Middleware Control.
2. Close the browser window.

12.3 Displaying Menus and Pages in Fusion Middleware Control

Fusion Middleware Control displays OAM Farm page and associated information, summary, and cluster or server pages.

This section provides the following topics for Access Manager and Security Token Service:

- [Farm Page in Fusion Middleware Control](#)
- [Context Menus and Pages in Fusion Middleware Control](#)
- [Displaying Context Menus and Target Details in Fusion Middleware Control](#)

See Also:

Oracle Fusion Middleware Administrator's Guide for details about getting started using Fusion Middleware Control

12.3.1 Farm Page in Fusion Middleware Control

Each OAM Farm page in Fusion Middleware Control includes similar information.

Figure 12-2 illustrates the OAM Farm page in Fusion Middleware Control. The Farm Resource Center provides immediate access to online information.

Figure 12-2 OAM Farm Page in Fusion Middleware Control

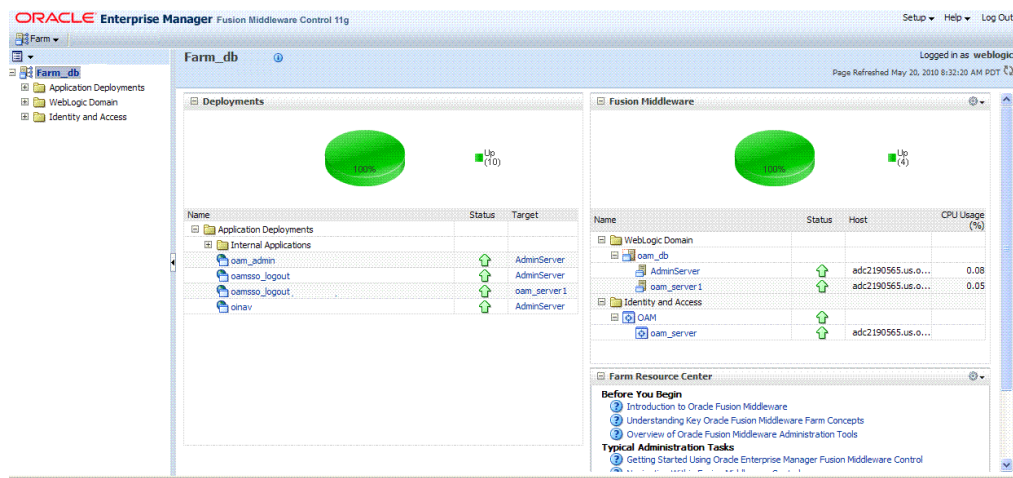

Sections on the Farm page are described in Table 12-1.

Table 12-1 Farm Page Sections

Farm Page Sections	Description
Deployments	<p>Within the farm, this section displays the Status and Target of each Internal Application within the Application Deployment.</p> <p>Clicking any link in the Deployments section (or in the navigation tree) displays a page containing more information.</p>
Fusion Middleware	<p>Within the farm, this section displays the status, host, and CPU usage for server instances in the:</p> <ul style="list-style-type: none"> WebLogic Server domain Identity and Access <p>Clicking any link on the page (or in the navigation tree) displays a page containing a more detailed summary.</p>
Farm Resource Center	<p>Provides a wealth of online information in the following categories:</p> <ul style="list-style-type: none"> Information that is useful before you begin using Fusion Middleware Control Administrator tasks using Fusion Middleware Control Other resources <p>Clicking any link in the resource center displays information on the chosen subject. With a wealth of information online, these details are not repeated in this book.</p>

The navigation tree on the left side of the page, like the one in [Figure 12-3](#), enables you to choose a specific instance (target) on which to operate regardless of the page you are currently viewing. Target names in your environment will be different.

Figure 12-3 Farm Navigation Tree in Fusion Middleware Control

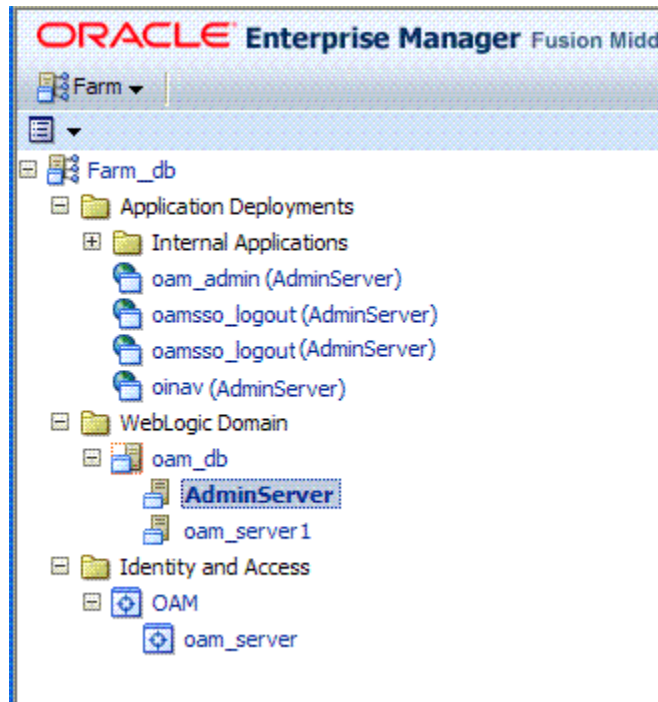

For more information, see "[Logging In To Fusion Middleware Control](#)".

See Also:

"[Displaying Menus and Pages in Fusion Middleware Control](#) "

12.3.2 Context Menus and Pages in Fusion Middleware Control

For Oracle Access Management, Farm details in Fusion Middleware Control are divided into four nodes within the navigation tree.

The nodes are:

- Application Deployments
- Internal Applications (includes logout page and other details for the OAM AdminServer and OAM Server instances)
- WebLogic Server domains (WebLogic Server details, including the OAM Farm)
- Identity and Access (includes OAM Cluster or individual OAM Server instances)

Clicking a node in the navigation tree displays an information page with individual links and a description of the Target, Type, and Full Name, as shown in [Figure 12-4](#) for Application Deployments.

Figure 12-4 Node Information Page in Fusion Middleware Control

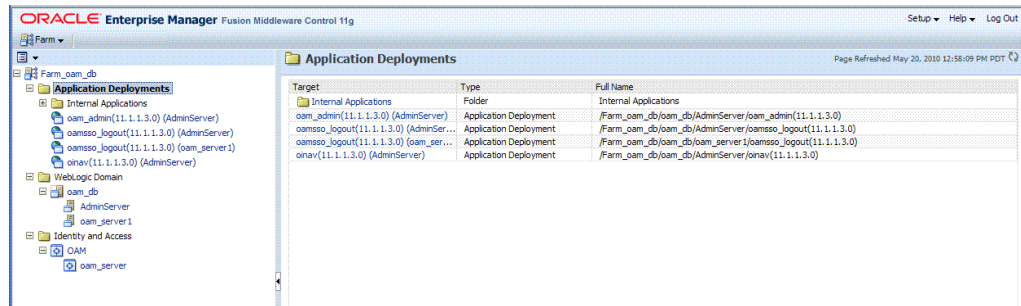

Clicking an instance (target) name (from either the navigation tree or a page), displays a context menu and a more detailed summary page. The Internal Application target is highlighted in the navigation tree and a page of the same name is displayed on the right. The context menu is available beneath the target name at the top of the page, as shown in Figure 12-5.

Figure 12-5 Application Deployment Summary for the Selected Internal Application

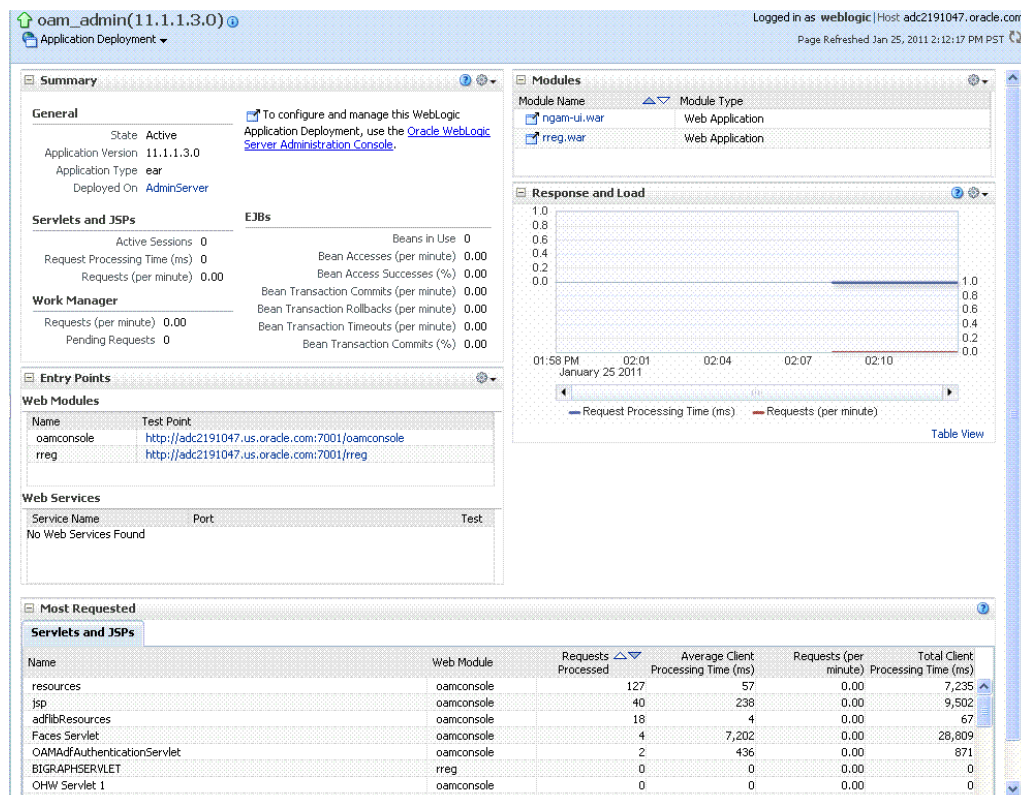

The Application Deployment menu is shown in Figure 12-6.

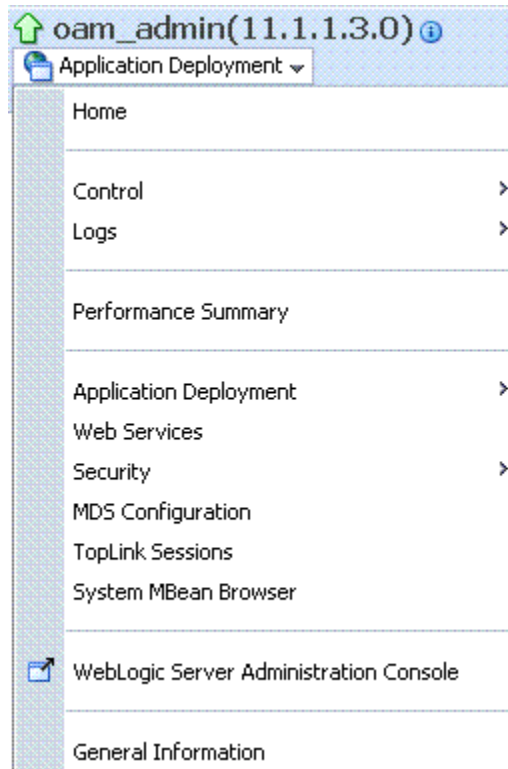
Figure 12-6 Application Deployment Menu

WebLogic Server domain: The WebLogic Server domain page is shown in [Figure 12-7](#) with the corresponding menu displayed. The Oracle WebLogic Server domain Resource Center, with links to online documentation, is visible in the bottom-left corner. This page more closely resembles the Farm landing page.

Figure 12-7 WebLogic Server Domain Summary with Context Menu Exposed

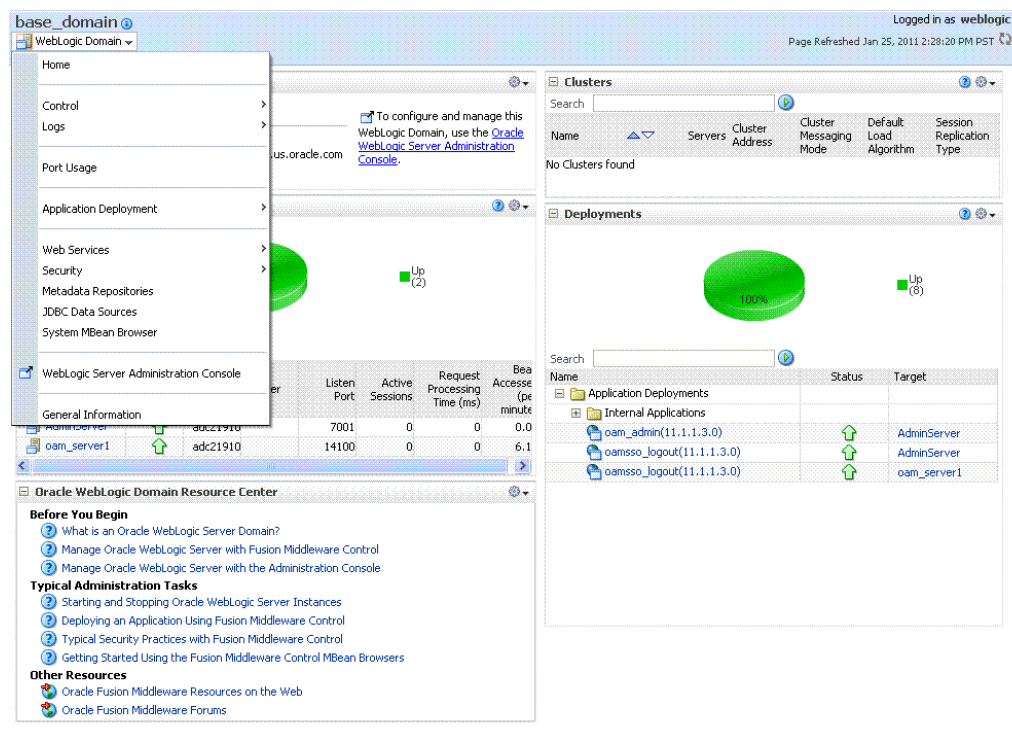

Selecting a target name within the WebLogic Server domain node displays a target summary page that more closely resembles the Application Deployment page in [Figure 12-5](#).

For more information, see "[Displaying Context Menus and Target Details in Fusion Middleware Control](#)".

See Also:

"[Viewing Performance in Fusion Middleware Control](#)" for information about the Identity and Access node and related pages.

12.3.3 Displaying Context Menus and Target Details in Fusion Middleware Control

Fusion Middleware Control Administrators can view context menus and target pages.

Note:

From the Farm Resource Center on the OAM Farm page, choose topics of interest (or click Help in the upper-right corner of the page) to get more information.

See Also:

"[Context Menus and Pages in Fusion Middleware Control](#)"

1. Log in as described in "[Logging In To Fusion Middleware Control](#)".

2. Expand the Farm containing Oracle Access Management, if needed.
3. **Information Pages:** From the navigation tree, click one of the following to display the related information page:
 - Application Deployments
 - WebLogic Server domain
 - Identity and Access
4. **Menus and Summary Pages:** Click an instance name (in either the navigation tree or the related page) to display a summary page and menu ([Figure 12-5](#) and [Figure 12-6](#)).
5. **Cluster or Server Pages:** See "[Viewing Performance in Fusion Middleware Control](#)".

12.4 Viewing Performance in Fusion Middleware Control

Fusion Middleware Control provides various performance metrics for administrators.

The following sections provide more details:

- [Performance Overview Pages in Fusion Middleware Control](#)
- [Metrics Palette and the Performance Summary Page](#)
- [Displaying Performance Metrics in Fusion Middleware Control](#)
- [Displaying Component-Specific Performance Details](#)
- [Resulting Pages for Selected Nodes and Targets](#)

12.4.1 Resulting Pages for Selected Nodes and Targets

Using Fusion Middleware Control, you can view performance metrics for live sessions in a variety of formats.

Fusion Middleware Control provides Administrators with:

- A cluster-wide view of performance for Access Manager with Security Token Service
- A per-server drill-down of key performance metrics
- The ability to quickly add or remove performance metrics

[Table 12-2](#) summarizes the pages for selected nodes and target instances.

Table 12-2 Resulting Pages for Selected Nodes and Targets

Node	Target	Information Summary Page	Performance Overview	Performance Summary w/ Metrics
Application Deployment	...AdminServer	Yes	No	Yes
Internal Applications	oamsso_logout(11.1.1.3.0)	Yes	No	Yes
	AdminServer	Yes	No	Yes
	oamsso_logout(11.1.1.3.0)			
	oam_server			
WebLogic Server domain	oam_bd (Cluster name)	Yes	No	No
	AdminServer	Yes	No	Yes
	oam_server	Yes	No	Yes
Identity and Access	OAM (Cluster)	No	Yes	Yes
	oam_server (Server)	No	Yes	Yes

Note:

Security Token Service performance is included with relevant OAM Cluster and Server pages.

12.4.2 Performance Overview Pages in Fusion Middleware Control

The Fusion Middleware Control Performance Overview can be used to reflect WebLogic cluster information down to specific performance metrics for individual Cluster and Server targets.

Cluster Page: The top node within Identity and Access leads to a page for the OAM Cluster Deployment, which includes a Performance Overview. For [Figure 12-8](#), the Cluster is selected in the navigation tree, beneath the Identity and Access node. [Figure 12-8](#) illustrates the Cluster Deployments and Performance Overview sections. This page includes a table for Token Issuance and Token Validations.

Figure 12-8 Cluster Page

OAM Server Pages: Selecting an OAM Server target name from the navigation tree (or the open page), displays a Performance Overview for the target. At the top of the OAM Server page, a summary of Key Metrics for the server instances appears instead of the Cluster Deployment section. Figure 12-9 illustrates the OAM Server instance Key Metrics, which include Token Issuance and Token Validations per second. The Token Validation success rate is included.

Figure 12-9 Key Metrics for Server Page

Table 12-3 describes the elements of the Performance Overview for Clusters and OAM Server instances in Fusion Middleware Control. There are only a few differences.

Table 12-3 Summary of Performance Overviews in Fusion Middleware Control

Section or Column Name	Description
Cluster Menu	<p>Dynamic context menus provide functions related to the selected target (also available when you right-click a target in the navigation tree). This menu is available for the selected Cluster.</p>  <p>The Component Performance command enables you to choose between displaying Access Manager or Security Token Service metrics.</p> <p>See Also: "Access Manager Component Pages" and "Security Token Service Component Pages".</p>
Deployments, OAM Cluster pages	<p>This section appears only on OAM Cluster pages. It describes the status of each instance in the cluster. The following information is included:</p> <ul style="list-style-type: none"> • Instance Name • Status • Authentications • Authorizations
Instance Name	<p>This column includes the name of each OAM Server instance in the cluster. For example:</p> <p><i>OAM_server_name</i></p>
Status	<p>This column identifies the status of each OAM Server instance in the cluster with either a:</p> <ul style="list-style-type: none"> • Green Up Arrow (running) • Red Down Arrow (not running)
Authentications	<p>Authentications columns identify:</p> <ul style="list-style-type: none"> • Authentications/sec: The number of authentications per second for each OAM Server instance in the cluster • Success Rate (% of Authentications Successful): A numeric value representing the percentage of successful authentications for each OAM Server instance in the cluster
Authorizations	<p>This column identifies the number of authorizations per second for each OAM Server instance in the cluster.</p> <p>Authorizations columns identify:</p> <ul style="list-style-type: none"> • Authorizations/sec: The number of authorizations per second for each OAM Server instance in the cluster • Success Rate (% of Authorizations Successful): A numeric value representing the percentage of successful authorizations for each OAM Server instance in the cluster

Table 12-3 (Cont.) Summary of Performance Overviews in Fusion Middleware Control

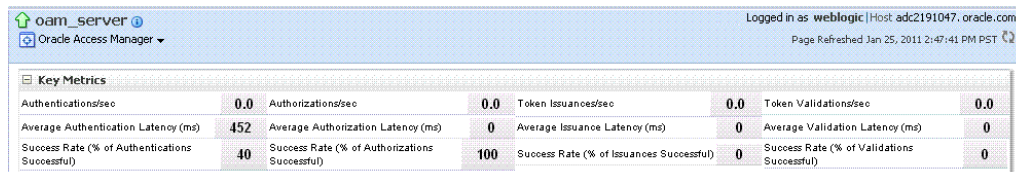
Section or Column Name	Description
Server Instance Menu	Dynamic context menus provide functions related to the selected target (also available when you right-click a target in the navigation tree). This menu is available for the selected server instance.

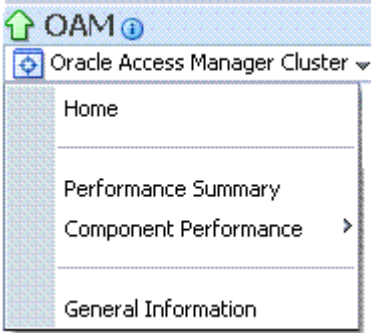
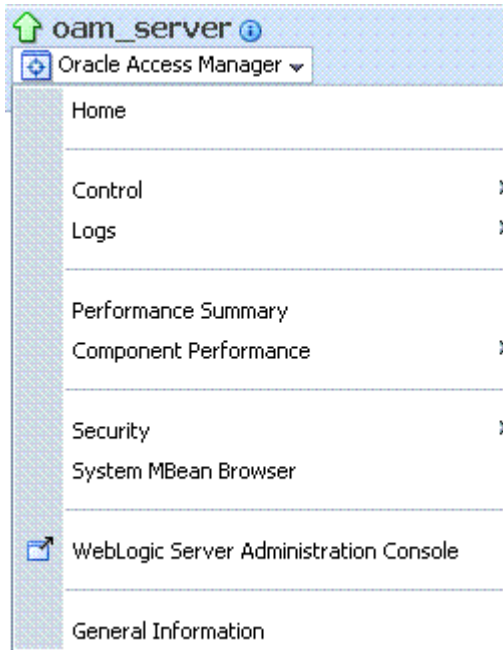

The Component Performance command enables you to choose between displaying specific Access Manager or Security Token Service metrics.

See Also: "[Access Manager Component Pages](#)" and "[Security Token Service Component Pages](#)".

Key Metrics, OAM Server Page	<p>This table provides a summary of statistics for only the selected OAM Server instance. Key metrics include details for both Access Manager and Security Token Service:</p> <ul style="list-style-type: none"> • Authentications/sec, Average Authentication Latency (ms), and Success ratio • Authorizations/sec, Average Authorization Latency (ms), and Success ratio • Token Issuances/sec, Average Issuance Latency (ms), and Success ratio • Token Validations/sec, Average Validation Latency (ms), and Success ratio
------------------------------	--

Table 12-3 (Cont.) Summary of Performance Overviews in Fusion Middleware Control

Section or Column Name	Description
Performance Overview, OAM Cluster and OAM Server Pages	<p>This section provides a graphic representations of Access Manager authentication and authorization operations and Security Token Service Token Issuance and Token Validation operations. Metrics in the Performance Overview are not configurable. The Metrics Palette is available for only the Performance Summary.</p> <p>Whether you have an OAM Cluster or OAM Server instance selected, the Performance Overview includes:</p> <ul style="list-style-type: none"> • Authentications/sec and Authorizations/sec • Token Issuances/sec and Token Validations/sec <p>Within each table:</p> <ul style="list-style-type: none"> • Coordinates along the horizontal axis (the x axis) identify the time period. • Coordinates along the vertical axis (the y axis) identify the number of named transactions that occurred during the time period.
Table View	Click the Table View link on the bottom-right side of the Performance Overview to display performance information in columns within a pop up window.
LDAP Servers, OAM Cluster and OAM Server Pages	<p>This section is available when either an OAM Cluster or a single OAM Server instance is selected. It provides information for the default LDAP user identity store:</p> <ul style="list-style-type: none"> • LDAP operations/sec • LDAP Latency (milliseconds) • LDAP Success Rate
Application Domains, OAM Cluster and OAM Server Pages	<p>This section of the OAM Cluster and OAM Server pages provides information for all Application Domains that were used during authentication and authorization processing.</p> <p>Columns in this section provide the:</p> <ul style="list-style-type: none"> • Application Domain Name: Each Application Domain that contains the authentication and authorization policies used for a request. • Authentications/sec, Authentications Latency (ms), Success Ratio (%) for each Application Domain • Authorizations/sec, Authorization Latency (ms), Success Ratio (%) for each Application Domain

12.4.2.1 Access Manager Component Pages

The Component Performance command on both the Cluster and Server instance menus enables you to display Access Manager-specific metrics.



Cluster component-specific metrics are aggregated across the cluster, illustrated in [Figure 12-10](#). Details follow in [Table 12-4](#).

Figure 12-10 Aggregated Access Manager Component Metrics for the Cluster

Client ID	Type	Authentications			Authorizations		
		Authentications/sec	Latency (ms)	Success Rate (%)	Authorizations/sec	Latency (ms)	Success Rate (%)
Agent_IDMDomainAgent	OAM WebGate	N/A	N/A	N/A	0.0	4	100

Figure 12-11 illustrates the Access Manager component metrics for a single OAM Server instance.

Figure 12-11 Access Manager Component Metrics for a Single OAM Server Instance

Client ID	Type	Authentications			Authorizations		
		Authentications/sec	Latency (ms)	Success Rate (%)	Authorizations/sec	Latency (ms)	Success Rate (%)
Agent_IDMDomainAgent	OAM WebGate	N/A	N/A	N/A	0.0	4	100

Table 12-4 describes the component-specific metrics for Access Manager.

Table 12-4 Access Manager Component Metrics

Access Manager Metrics	Description
Access Manager Clients	Based on your selection (Cluster or Server instance), this page provides information for all active Access Clients in a cluster (or for the active Access Clients of an individual OAM Server). Details include: <ul style="list-style-type: none"> Client ID Type Authentications Authorizations
Client ID	Displays the name of the Agent, as defined in the Agent registration in the Oracle Access Management Console. For example: IAMSuiteAgent
Type	Displays the Agent. type For example: OAM Webgate
Authentications	Authentications columns identify: <ul style="list-style-type: none"> Authentications/sec: The number of authentications per second for each OAM Server instance in the cluster Latency (ms): The number of milliseconds the authentication was delayed Success Rate (%): A numeric value representing the percentage of successful authentications for each OAM Server instance in the cluster

Table 12-4 (Cont.) Access Manager Component Metrics

Access Manager Metrics	Description
Authorizations	<p>Authorizations columns identify:</p> <ul style="list-style-type: none"> • Authorizations/sec: The number of authorizations per second for each OAM Server instance in the cluster • Latency (ms): The number of milliseconds the authorization was delayed • Success Rate (%): A numeric value representing the percentage of successful authorizations for each OAM Server instance in the cluster

12.4.2.2 Security Token Service Component Pages

The Component Performance command on both the Cluster and Server instance menus enables you to display Security Token Service component-specific metrics.



Component-specific metrics are aggregated for the Cluster, as illustrated in [Figure 12-10](#).

Figure 12-12 Aggregated STS Component Metrics for the Cluster

Security Token Service

Requester Partners (Aggregated)

Select a partner to view more details.

Partner ID	Token Issuance			Token Validation		
	Total Requests	Requests/sec	Average Issuance Latency (ms)	Total Requests	Requests/sec	Average Validation Latency (ms)
requester-test	0	0.0	0	0	0.0	0

Token Operations (Aggregated)

Token Type	Total Tokens Generated	Token Issuance		Total Tokens Validated	Token Validation	
		Requests/sec	Average Issuance Latency (ms)		Requests/sec	Average Validation Latency (ms)
Username				4	0.0	194

For each individual server instance, STS component-specific metrics are also available, as illustrated in [Figure 12-10](#).

Figure 12-13 STS Component Metrics for an Individual OAM Server Instance

Table 12-5 introduces the STS component specific metrics.

Table 12-5 STS Component-Specific Metrics

Security Token Service Metrics	Description
Requestor Partners	<p>Statistics summary for either the selected OAM Server instance (or an aggregated summary for the Cluster):</p> <ul style="list-style-type: none"> Partner ID Token Issuances Token Validations <p>Selecting a Requestor Partner ID reveals Relying Party Details with specific information for only the named partner.</p>
Token Operations	<p>Metrics for STS Token Operations include:</p> <ul style="list-style-type: none"> Token Type Token Issuances: Total Requests, Requests per second, Average Issuance Latency (ms) Token Validations: Total Requests, Requests per second, Average Issuance Latency (ms)

12.4.3 Metrics Palette and the Performance Summary Page

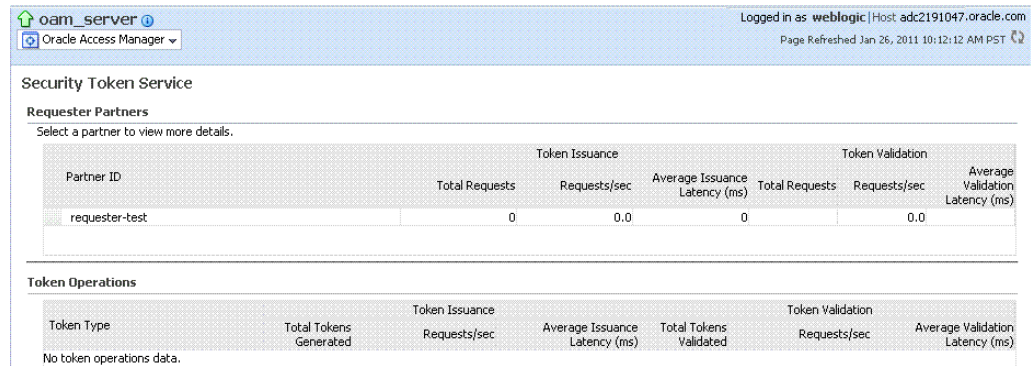
The Performance Summary command on the Cluster or Server menu displays metrics charts for the selected target.

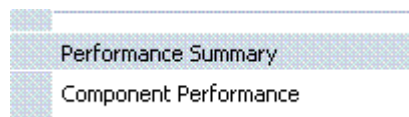
Figure 12-14 Performance Summary Command

On the Performance Summary page, a chart is displayed for each selected metric. An OAM Server Performance Summary page. Figure 12-15 shows the Performance Summary page with an open Metric Palette from which you can choose metrics to chart. Stacked charts allow you to easily compare multiple metrics for the same time frame, change the time frame to go back in time, or zoom in or out.

Figure 12-15 Performance Summary Page with Metric Palette

Table 12-6 describes the status and controls available on the Performance Summary page.

Table 12-6 Status and Controls on Performance Summary Pages

Status or Control	Description
Past <i>n</i> minutes	Status is based on the specified time period, which can be adjusted using the slider.
All	
<i>n</i> Minutes	The specified time period, which can be adjusted using the slider.
Slider	The tool you use to adjust the time period.
Chart Set	A list from which you can choose the set of saved charts to view.

Performance Summary ?

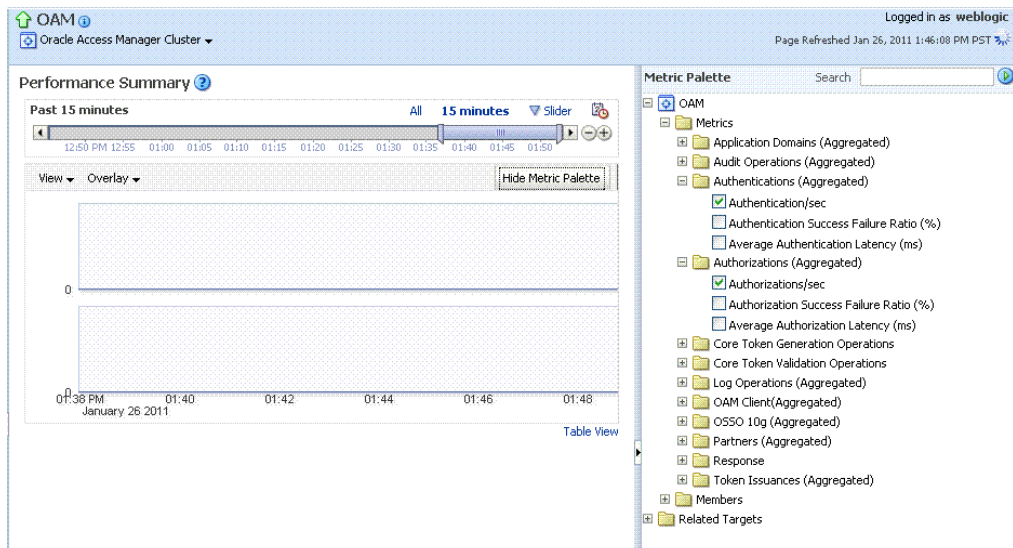
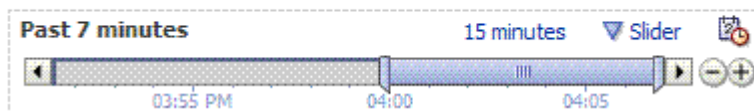

Table 12-6 (Cont.) Status and Controls on Performance Summary Pages

Status or Control	Description
View	<p data-bbox="618 317 1453 380">A menu that enables you to add a grid, save a chart, and order information on the page.</p> 
Overlay	<p data-bbox="618 785 1453 848">A menu that enables you to search for and view another instance of the same type and compare this against the instance in the summary.</p> 

Table 12-6 (Cont.) Status and Controls on Performance Summary Pages

Status or Control	Description
Metric Palette	A listing from which you can select performance metrics to chart. Items unique to Access Manager and Security Token Service are shown here. Left: Metric Palette for the Cluster Right: Metric Palette for a Single OAM Server

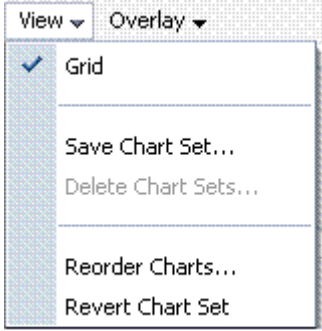
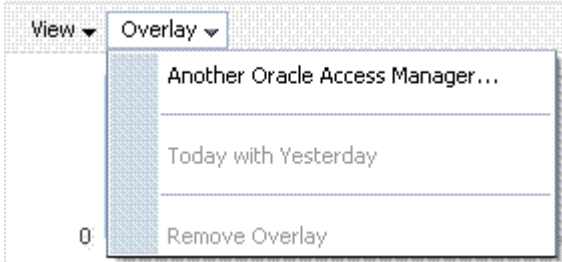
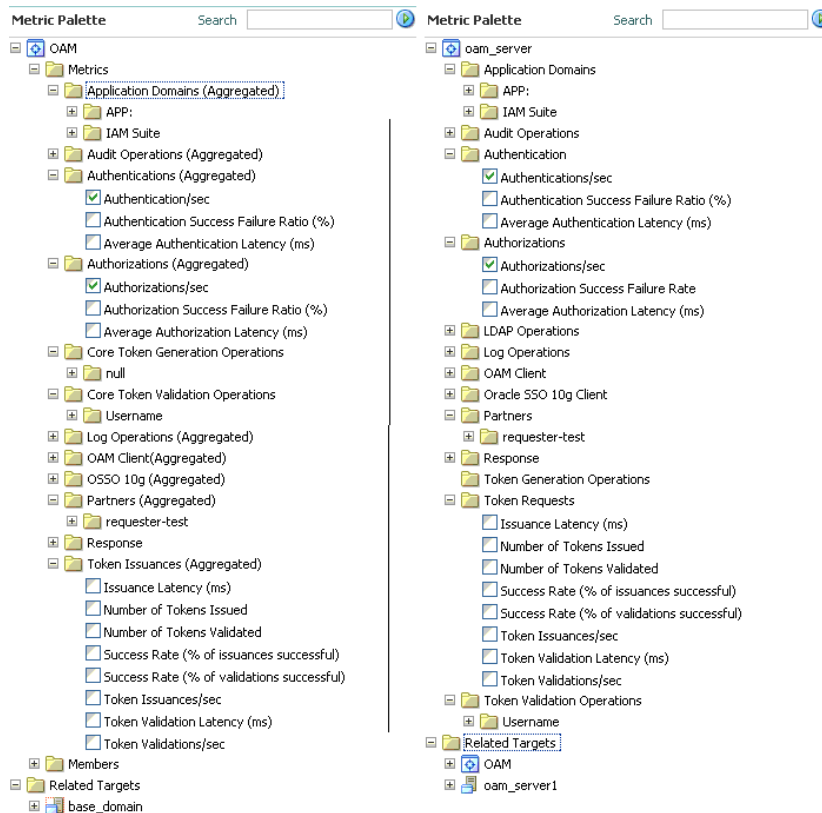

12.4.4 Displaying Performance Metrics in Fusion Middleware Control

Fusion Middleware Control Administrators can add or change the metrics that are displayed in the Performance Summary.

See Also:

- ["Performance Overview Pages in Fusion Middleware Control "](#)
- ["Metrics Palette and the Performance Summary Page"](#)

1. Log in as described in ["Logging In To Fusion Middleware Control"](#).

2. **Performance Overview:**

- Expand the desired node and select a target. For example: Identity and Access.

Identity and Access
oam_server

- b. Review the Performance Overview.
3. **Performance Summary:**
 - a. Select a target (Step 1).
 - b. From the context menu, select Performance Summary.
 - c. Review the Summary Page.
4. **Changing Metrics:**
 - a. From the Performance Summary page (Step 2), click the **Show Metrics Palette** button.
 - b. From the Metrics Palette, expand nodes and check (or clear) boxes to add (or remove) metrics from the summary.
 - c. Review the updated the Summary page.
 - d. Click **Hide Metrics Palette** when you finish.
5. **Saving a Chart Set:**
 - a. From the View menu on the Performance Summary page, click **Save Chart Set**.
 - b. In the dialog box that appears, enter a unique name for this chart set and click **OK** when the operation is confirmed.
 - c. Click **Hide Metrics Palette** when you finish.
 - d. Review the updated information on the Summary Page.
6. **Adding an Overlay, Access Manager:**
 - a. From the Overlay menu on the Performance Summary page, click **Another Oracle Access Manager**.
 - b. In the Search and Select Targets dialog, enter the target name and host name, then click **Go**.
 - c. In the target results table, click the name of the desired target and then **Select**.
 - d. When finished viewing the overlay, click **Remove Overlay** from the Overlay menu.
7. **Adding an Overlay, Today with Yesterday:**
 - a. From the Overlay menu on the Performance Summary page, click **Today with Yesterday**.
 - b. When finished viewing the overlay, click **Remove Overlay** from the Overlay menu.
8. **Testing:**

- a. Using the Access Tester, perform several authentication and authorization tests (see [Validating Connectivity and Policies Using the Access Tester](#)).
- b. In Fusion Middleware Control, check performance metrics.

12.4.5 Displaying Component-Specific Performance Details

Fusion Middleware Control Administrators can use the following procedure to view and compare component-specific performance data.

See Also:

- ["Access Manager Component Pages"](#)
 - ["Security Token Service Component Pages"](#)
-
-

1. Log in as described in "[Logging In To Fusion Middleware Control](#)".
2. Expand the desired node and select a target. For example:
 Identity and Access
 oam_server
3. From the context menu, select **Component Performance**.
4. Choose **Access Manager** (or **Security Token Service**).
5. **STS Partner ID:** Choose a Partner ID in the **Security Token Service** results table for more details, if needed.
6. **Component Performance:**
 - a. From the context menu, select Component Performance.
 - b. Choose either **Access Manager** (or **Security Token Service**).
 - c. Choose an item in the results table to get more details, if available.
7. **Testing:**
 - a. Using the Access Tester, perform several authentication and authorization tests (see [Validating Connectivity and Policies Using the Access Tester](#)).
 - b. In Fusion Middleware Control, check performance metrics.

12.5 Managing Log Level Changes in Fusion Middleware Control

Oracle Fusion Middleware components generate log files containing messages that record all types of events.

Administrators can set log levels using Fusion Middleware Control, as described in this chapter.

Note:

Alternatively, Administrators can set OAM logger levels using custom WebLogic Scripting Tool (WLST) commands, as described in [Logging Component Event Messages](#).

Topics in this section include:

- [Dynamic Log Level Changes in Fusion Middleware Control](#)
- [Setting Log Levels Dynamically Using Fusion Middleware Control](#)

12.5.1 Dynamic Log Level Changes in Fusion Middleware Control

Using Fusion Middleware Control, Administrators can change log levels dynamically for **Access Manager** (or **Security Token Service**).

[Table 12-7](#) outlines log availability and functions in Fusion Middleware Control.

Table 12-7 OAM Log Availability and Functions in Fusion Middleware Control

Node	Target	View Log Messages	Log Configuration
Application Deployment	...AdminServer	Yes	Yes
Internal Applications	oamsso_logout(11.1.1.3.0) AdminServer	Yes	Yes
	oamsso_logout(11.1.1.3.0) oam_server	Yes	Yes
WebLogic Server domain	oam_bd (Cluster name)	Yes	No
	AdminServer	Yes	Yes
	oam_server	Yes	Yes
Identity and Access	OAM (Cluster)	No	No
	oam_server (Server)	Yes	Yes

[Figure 12-16](#) shows the Log Levels configuration page in Fusion Middleware Control. Notice that Runtime Loggers is the selected View and oracle.oam logger names are currently displayed. With Security Token Service there is only one logger that affects the log levels for Security Token Service: `oracle.security.fed`.

Figure 12-16 Access Manager Log Levels on the Log Configuration Tab

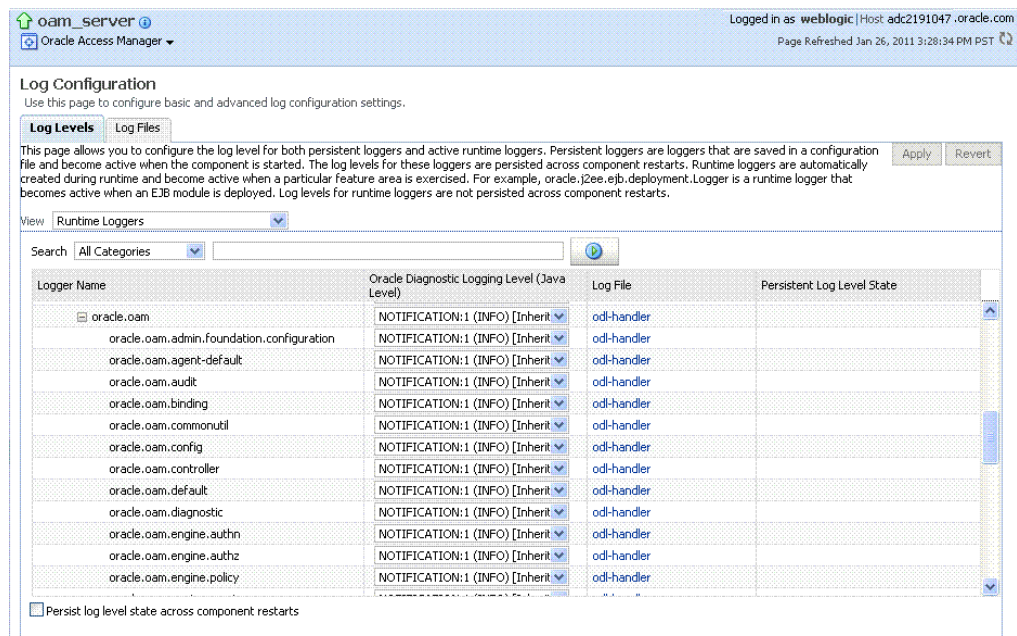
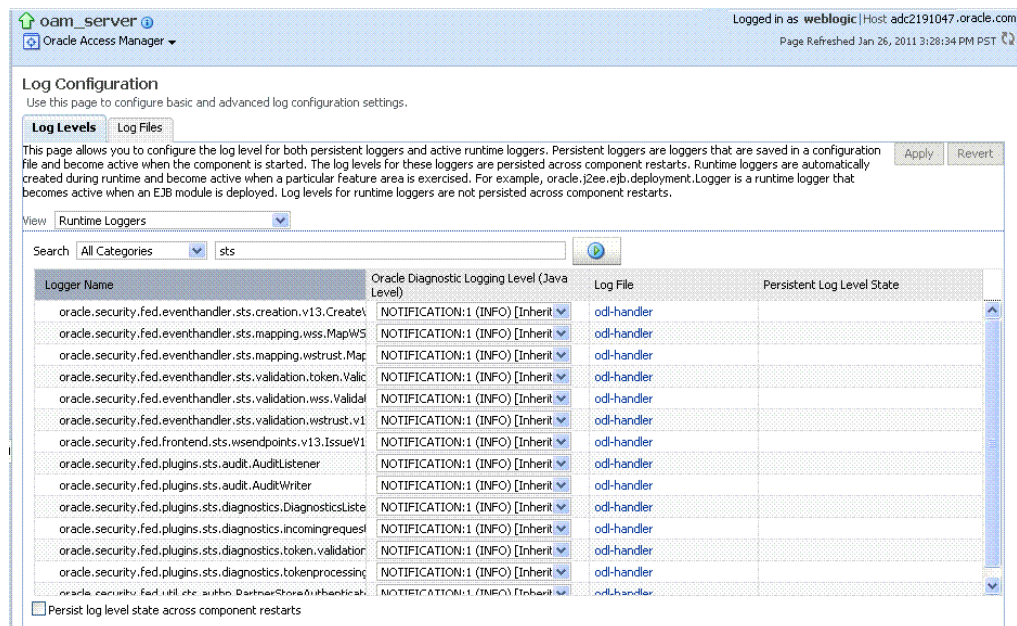

Figure 12-17 Log Levels for Security Token Service



The Log Levels tab on the Log Configuration page allows you to configure the log level for both persistent loggers and active runtime loggers:

- Persistent loggers are saved in a configuration file and become active when the component is started.
The log levels for these loggers are persisted across component restarts.
- Runtime loggers are automatically created during runtime and become active when a particular feature area is exercised.

For example, oracle.j2ee.ejb.deployment.Logger is a runtime logger that becomes active when an EJB module is deployed. Log levels for runtime loggers are not persisted across component restarts.

Table 12-8 explains the configuration status and options for log levels.

Table 12-8 Log Levels Tab on Log Configuration Page

Element	Description
Apply	Submits and applies log level configuration changes, which take affect immediately.
Revert	Restores the target's previous log level configuration, which take affect immediately.
View	Use this list to view runtime loggers or loggers with a persistent log level state. <ul style="list-style-type: none"> Runtime Loggers Loggers with Persistent Log Level State
Search	Use this list to specify the categories you would like to search.

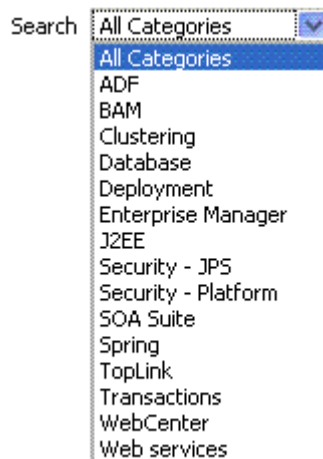

Table

Logger Name The name of the loggers found during the search. You can expand names in the list to see any loggers beneath the top node.

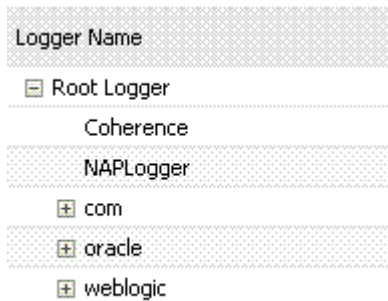
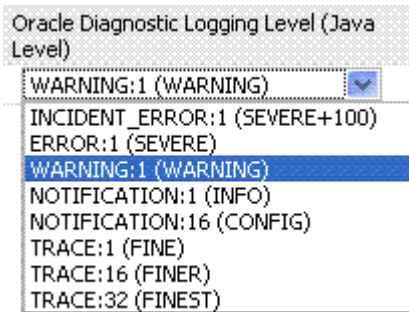

Table 12-8 (Cont.) Log Levels Tab on Log Configuration Page

Element	Description
Oracle Diagnostic Logging Level (Java Level)	<p>Choose the logging level for the corresponding logger; c.</p>  <p>Click Apply and review confirmation messages displayed in a pop-up window:</p> <ul style="list-style-type: none"> Updating log levels Updating the log levels of runtime loggers The log levels of runtime loggers have been updated successfully The log levels have been updated successfully
Log File	<p>Clicking a name in the Log File column displays the Log Files page, which you can use to create and edit the file where log messages are logged, the format of the log messages, rotation policies, and other logging parameters.</p> <p>See Also: "Managing Log File Configuration from Fusion Middleware Control".</p>
Persistent Log Level State	<p>Identifies the persistent state for this specific logger, which is set when you create or edit the value using the Log Files tab.</p>

12.5.2 Setting Log Levels Dynamically Using Fusion Middleware Control

Fusion Middleware Control Administrators can set the log level dynamically.

See Also:

["Dynamic Log Level Changes in Fusion Middleware Control"](#)

Note:

Administrators can also set logger levels using custom WLST commands as described in [Logging Component Event Messages](#) .

1. Log in as described in "[Logging In To Fusion Middleware Control](#)".
2. Expand the desired node, and select a target. For example:

Identity and Access

oam_server

3. From the Access Manager context menu, select Logs and then choose Log Configuration.
4. From the Log Levels tab, View list, choose the loggers to display. For example: **Runtime Loggers**.
5. From the Search list, choose a category, enter your search criteria, and click the search button. For example: **All Categories sts**.
6. In the results table, expand nodes to reveal information as needed.
7. In the results table, choose log levels for your environment, then click Apply (or Revert).
8. Proceed to "[Managing Log File Configuration from Fusion Middleware Control](#)"

12.6 Managing Log File Configuration from Fusion Middleware Control

Fusion Middleware Control Administrators can create, edit, or view the log file.

This section provides the following information:

- [Log File Configuration Page in Fusion Middleware Control](#)
- [Managing Log Files with Fusion Middleware Control](#)

12.6.1 Log File Configuration Page in Fusion Middleware Control

Use the Log Files Configuration page to create and edit where the log messages will be logged to, the format of the log messages, the rotation policies used, as well as other parameters depending on the log file configuration class.

[Table 12-8](#) shows the Log Files Configuration.

Figure 12-18 Log Files Configuration Page

The screenshot shows the 'Log Configuration' page in Oracle Access Manager. It includes a header with the user 'weblogic' and the host 'adc2190565.oracle'. Below the header, there are tabs for 'Log Levels' and 'Log Files'. The 'Log Files' tab is active, displaying a table of log configurations. The table has columns for 'Handler Name', 'Log Path', 'Log File Format', and 'Rotation Policy'. There are also buttons for 'Create...', 'Create Like...', 'Edit Configuration...', and 'View Configuration...'.

Handler Name	Log Path	Log File Format	Rotation Policy
em-log-handler	/scratch/akolli/MW2/user_projects/domains/oam_db/servers/oam_server1/sysman/log/emoms.log	Oracle Diagnostics Logging - Text	Size Based
em-trc-handler	/scratch/akolli/MW2/user_projects/domains/oam_db/servers/oam_server1/sysman/log/emoms.trc	Oracle Diagnostics Logging - Text	Size Based
odl-handler	/scratch/akolli/MW2/user_projects/domains/oam_db/servers/oam_server1/logs/oam_server1-diagnostic.log	Oracle Diagnostics Logging - Text	Size Based
owsm-message-han	/scratch/akolli/MW2/user_projects/domains/oam_db/servers/oam_server1/logs/owsm/msglogging	Oracle Diagnostics Logging - Text	Size Based

[Table 12-9](#) describes the log files configuration parameters for Access Manager (or Security Token Service).

Table 12-9 Log Files Elements

Element	Description
Create	<p>Click this button to display the fresh form to create a new file for logged messages.</p> <ul style="list-style-type: none"> Log File is the name of the log handler (odl-handler for OAM) Log Path points to the logging output file in your environment, which you can change. The output logging file in your environment can have a unique file name.
	
Create Like	<p>Click this button to display a partially filled-in form to create a new file for logged messages.</p>
	
Edit Configuration	<p>Click this button to display and edit the selected log file configuration.</p>

Table 12-9 (Cont.) Log Files Elements

Element	Description
View Configuration	Click this button to view a read-only description of the selected log file configuration.
Table	The information in this table is based on log file configuration parameters in this table.
Handler Name	The Log File name assigned during log file creation.
Log Path	The file system directory path assigned during log file creation.
Log File Format	The Log File format assigned during log file creation.
Rotation Policy	The rotation policy selected during log file creation.

12.6.2 Managing Log Files with Fusion Middleware Control

Fusion Middleware Control Administrators can create a log file, edit the configuration, or view a read-only version of the log file configuration.

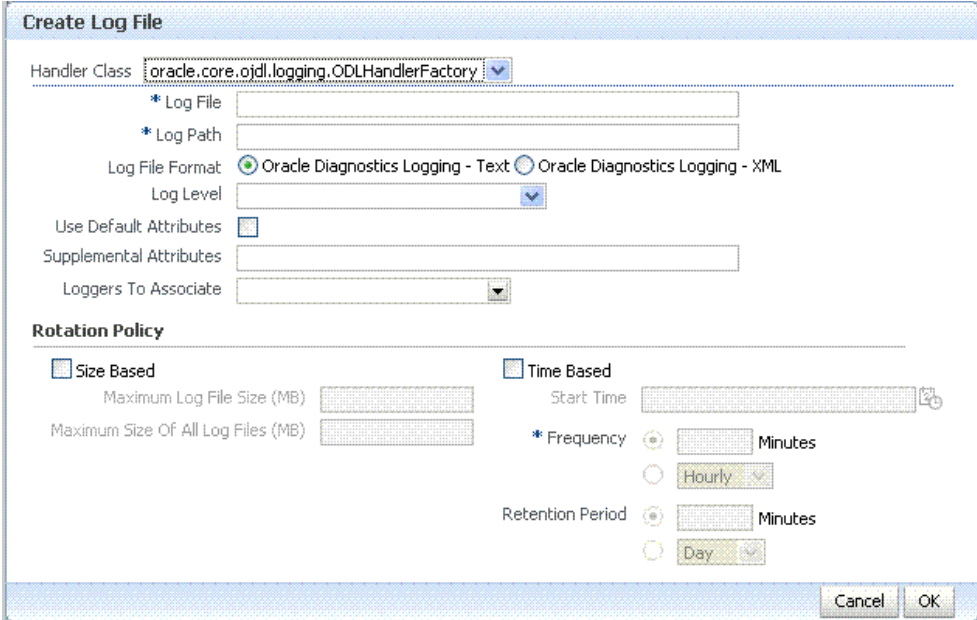
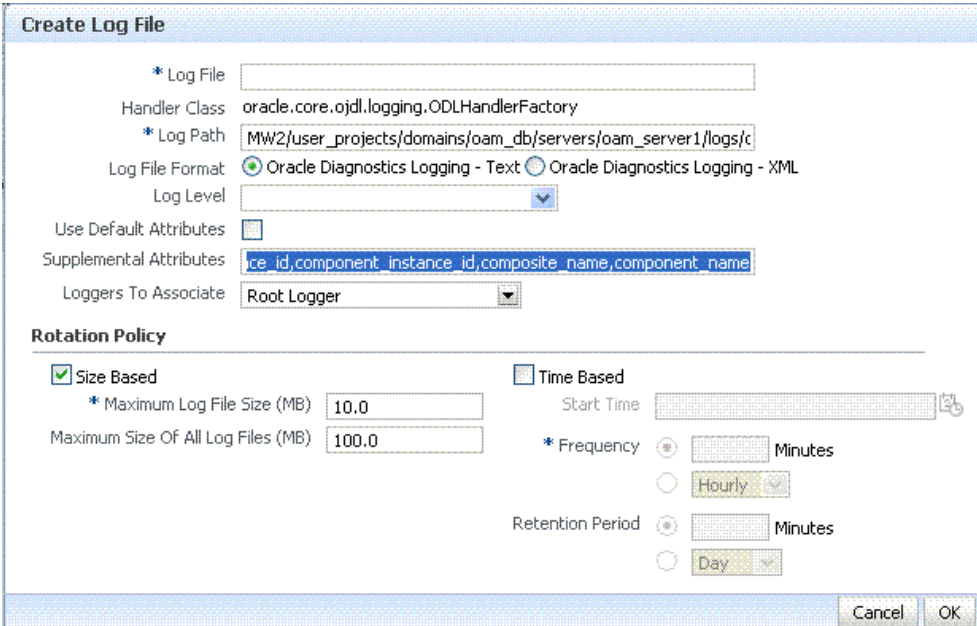
See Also:

["Log File Configuration Page in Fusion Middleware Control"](#)

1. Log in as described in "[Logging In To Fusion Middleware Control](#)".
2. Expand the desired node, and select a target. For example:
 - Identity and Access
 - oam_server
3. From the Access Manager menu, select Logs and then Log Configuration.
4. **Create a Log File:** From the Log Files tab ([Table 12-9](#)):
 - a. Click the **Create** button to display a fresh Create Log File form.
 - b. Enter a name and file system path for this log file. For example:
 - Log File **oam-od1-handler**
 - Log Path domains/**oam_db/servers/oam-server1/log/oam.log**
 - c. Click the desired Log File Format. For example: ... **Text**
 - d. Set the logging attributes. For example:
 - Use Default Attributes
 - Supplemental Attributes
 - e. Associate a Logger. For example: **Root Logger**
 - f. Specify the Rotation Policy. For example: **Size Based**

Maximum Log File Size (MB) **10.0**

Maximum Size of All Log File Size (MB) **1000.0**

- g.** Click OK to submit the configuration.

5. Create Like:

- a.** From the Log Files tab, click the name of an existing log file.
- b.** Click the **Create Like** button.
- c.** On the Create Log File form, enter your own information:
Log File name
Log Level
Attributes
- d.** Edit any other details as needed, then click **OK** to submit the configuration.

6. Edit Configuration:

- a.** From the Log Files tab, click the name of an existing log file.
- b.** Click the **Edit Configuration** button.
- c.** Change configuration details as needed.
- d.** Click **OK** to submit the changes.

7. View Configuration:

- a.** From the Log Files tab, click the name of an existing log file.
- b.** Click the **View Configuration** button.
- c.** Review the information, then click **OK** to dismiss the configuration page.
Contents are greyed out when opened for viewing configuration.

- 8.** Proceed to "[Viewing Log Messages in Fusion Middleware Control](#)".

12.7 Viewing Log Messages in Fusion Middleware Control

Fusion Middleware Control Administrators can locate, view and export log messages for the target.

This section includes the following topics:

- [About Finding, Viewing, and Exporting Log Messages](#)
- [Viewing Logged Messages With Fusion Middleware Control](#)

12.7.1 About Finding, Viewing, and Exporting Log Messages

By using the context menu for an OAM Server instance in Fusion Middleware Control, Administrators can locate, view, and export key log information.

The key log information can be managed for:

- Application Deployment targets, including the WebLogic (and OAM) AdminServer and the OAM SSO logout pages on both AdminServer and OAM Servers
- WebLogic Server domain targets, including the OAM Farm, AdminServer, and OAM Servers
- Identity and Access targets, including the OAM Farm, Clusters, and individual OAM Servers

Using log files to troubleshoot common problems requires that you:

- Get familiar with the Oracle Diagnostic Logging (ODL) format used by Oracle Fusion Middleware components. See *About Diagnostic Log Files in Securing Applications with Oracle Platform Security Services*
- Configure log files to collect the appropriate level of information
- Search, view and export key log information in the farm
- Correlate messages in log files across components

12.7.1.1 Log Messages Page in Fusion Middleware

Figure 12-19 shows the Log Messages page for Access Manager and Security Token Service in Fusion Middleware Control.

Figure 12-19 Typical Log Messages Page in Fusion Middleware Control

The screenshot displays the 'Log Messages' page for 'oam_server' in Fusion Middleware Control. The interface includes a search bar with filters for 'Date Range', 'Time Interval', 'Start Date', and 'End Date'. Below the search filters, there are checkboxes for 'Message Types' (Incident Error, Error, Warning, Notification, Trace, Unknown) and a 'Message' search field. The main area shows a table of log messages with columns: Time, Message Type, Message ID, Message, Execution Context (ECID), Relationship, and Log File. The table contains several rows of log messages, including warnings and errors related to SSO session operations and authentication failures. Below the table, there is a detailed view of a selected message (OAM-02055) showing its message level, relationship ID, component, module, and the specific message text.

Time	Message Type	Message ID	Message	Execution Context ECID	Relationship	Log File
Jan 24, 2011 3:33:42 PM PST	Warning	OAM-02055	Retrieve SSO session operation failed.	568db2236c9b49e3	0	oam_server1-diagnostic-8.log
Jan 24, 2011 3:33:42 PM PST	Warning	OAM-02055	Retrieve SSO session operation failed.	568db2236c9b49e3	0	oam_server1-diagnostic-8.log
Jan 24, 2011 3:33:42 PM PST	Error	OAM-18034	Session invalid as returned by PBL_check_valid_session_response responseEvent fail	568db2236c9b49e3	0	oam_server1-diagnostic-8.log
Jan 24, 2011 3:33:46 PM PST	Warning	OAM-18034	Authentication module configuration is not valid.	568db2236c9b49e3	0	oam_server1-diagnostic-8.log
Jan 24, 2011 3:33:46 PM PST	Error	OAMSSA-2000	Authentication Failure : No User found matching the criteria.	568db2236c9b49e3	0	oam_server1-diagnostic-8.log
Jan 24, 2011 3:33:52 PM PST	Warning	OAM-18034	Authentication module configuration is not valid.	568db2236c9b49e3	0	oam_server1-diagnostic-8.log
Jan 24, 2011 3:33:52 PM PST	Error	OAMSSA-2000	Authentication Failure : invalid username/password.	568db2236c9b49e3	0	oam_server1-diagnostic-8.log
Jan 24, 2011 3:33:58 PM PST	Warning	OAM-18034	Authentication module configuration is not valid.	568db2236c9b49e3	0	oam_server1-diagnostic-8.log
Jan 25, 2011 1:55:39 PM PST	Warning		2011-01-25 13:55:39.706/86261.485 Oracle Coherence GE 3.5.3/465p2 <Warning> (thre...	00001qu3TUPATOW	0	oam_server1-diagnostic-10.log
Jan 25, 2011 1:55:39 PM PST	Warning		2011-01-25 13:55:39.711/86261.489 Oracle Coherence GE 3.5.3/465p2 <Warning> (thre...	00001qu3TUPATOW	0	oam_server1-diagnostic-10.log

Rows Selected: 1 | Columns Hidden: 18 | Total Rows: 10

Selected Message (Warning):

Message ID: OAM-02055
 Message Level: 1
 Relationship ID: 0
 Component: oam_server1
 Module: oracle.oam.controller
 Message: Retrieve SSO session operation failed.

Host: adf2191047
 Host IP Address: 10.232.84.138
 User: <anonymous>
 Thread ID: [ACTIVE]ExecuteThread: '0' for queue: 'weblogic.kernel.Default (self-tuning)'
 ECID: 568db2236c9b49e3-3cs37431:12db40442b-8000-000000000000010

Table 12-10 describes elements on the Log Messages page in Fusion Middleware Control, which you can use to locate and view messages.

Table 12-10 OAM Log Message Search Controls in Fusion Middleware Control

Element	Description
Broaden Target Scope	Select items on this list to expand (or narrow) the targets that are used in this search: <ul style="list-style-type: none"> Oracle WebLogic Server domain OAM Cluster Oracle WebLogic Server Oracle Fusion Middleware Farm
Target Log Files...	Displays a list of all log files for the target scope from which you can select a specific log file to view or download.
Refresh Options	Select an item from this list to specify the refresh method: <ul style="list-style-type: none"> Manual Refresh 30 Second Refresh 1 Minute Refresh
Search Options	
Date Range	The period during which the desired set of messages was logged: <ul style="list-style-type: none"> Most Recent <ul style="list-style-type: none"> Minutes Hours Days Time interval <ul style="list-style-type: none"> Date Range Start Date End Date
Message Types	Check all message types that apply for this search: <ul style="list-style-type: none"> Incident Error Error Warning Notification Trace Unknown
Message	Choose an identifier from this list and add a value in the blank field beside it to refine your search criteria: <div style="border: 1px solid black; padding: 5px; margin-top: 10px;"> <p>Message contains ▼</p> <ul style="list-style-type: none"> is is not <li style="background-color: #e0e0e0;">contains does not contain starts with does not start with ends with does not end with matches does not match </div>

Table 12-10 (Cont.) OAM Log Message Search Controls in Fusion Middleware Control

Element	Description
Add Fields	Click this button to display a list of additional search criteria you can include.

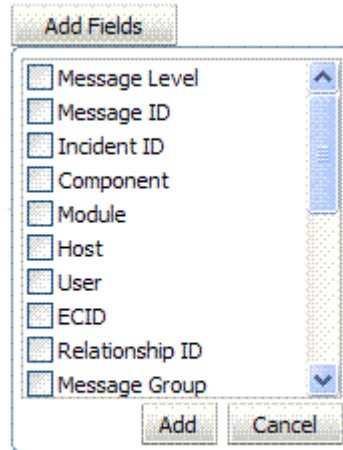

Search	Click this button to initiate a search using the specified criteria.
--------	--

Viewing Options

View	Choose items from this menu to view or reorder columns in the search results table:
------	---

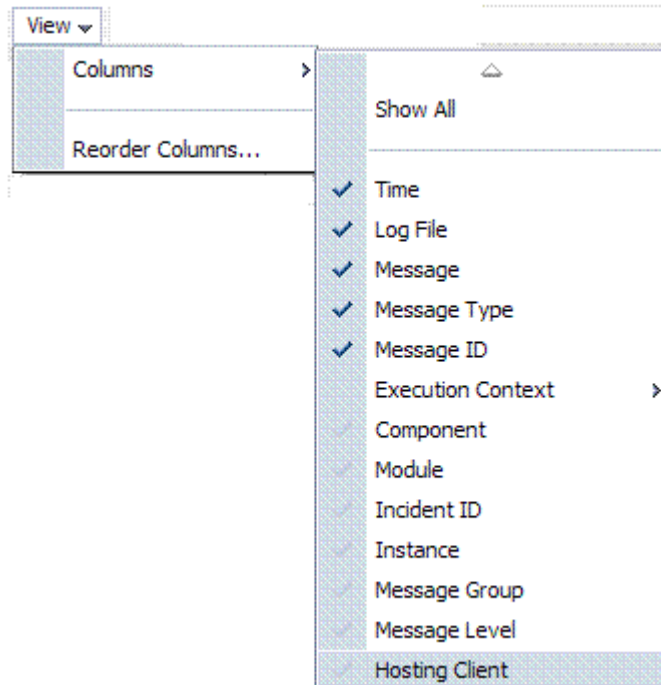
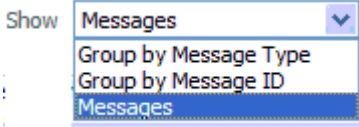
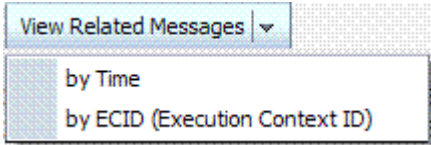
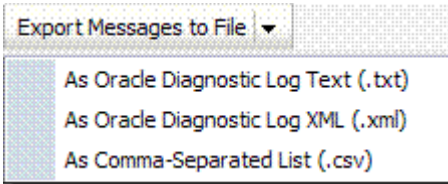

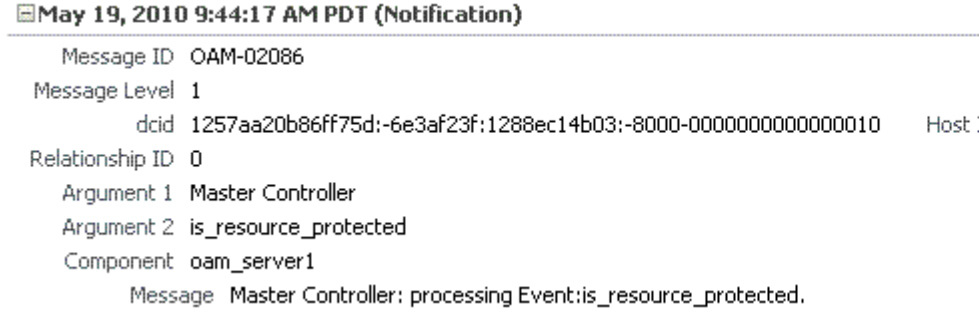

Table 12-10 (Cont.) OAM Log Message Search Controls in Fusion Middleware Control

Element	Description
Show	Select the entity to view: 
View Related Messages	This menu is available when at least one message is listed in the search results. 
Export Messages to a File	A menu of viewing commands that are available when at least one message is listed in the search results. You can choose from the following commands: 
Results Table Columns	These are based on selections in the View menu on the Log Messages page. 
Message Area	Displays details for the selected message in the search results table. 

12.7.2 Viewing Logged Messages With Fusion Middleware Control

Fusion Middleware Control Administrators can view and download log messages for the target.

This procedure explains how to search for messages, view messages (or view related messages), view all messages in a single log file, and export or download messages.

1. Log in as described in "[Logging In To Fusion Middleware Control](#)".
2. Expand the desired node and select a target. For example:
 - Identity and Access
 - oam_server
3. From the OAM context menu, select Logs and then choose View Log Messages.
4. **Search** ([Table 12-10](#)):
 - a. Specify a Date Range.
 - b. Check all Message Types to be included in your search.
 - c. Define Message content options.
 - d. Add Fields: Enter details to further refine message content.
 - e. Click Search to display a list of messages that fit your search criteria.
5. **View Messages:** From the table of search results, click one or more messages to view on the lower half of the page.
6. **View Related:** Use one of the following methods to organize the table of search results.
 - a. **By Time:** From the View Related menu, select **by Time**.
 - b. **By ECID:** Click ECID in the message on the screen (or, from the View Related menu, select **by ECID Execution Context ID**).
 - c. From the Scope menu, select a time period.
7. **Log File:** From the table of search results, click a name in the Log File column to view all messages in the file.
8. **Export Messages**
 - a. Select one or more messages in the search results table.
 - b. From the **Export Messages** menu, choose the desired export format. For example: **As Oracle Diagnostic Log (.txt)**.
 - c. In the dialog box, click **Open with** and then choose the desired program.
 - d. From the open program, save the file to a new path.
9. **Download**
 - a. Select one or more messages in the search results table.
 - b. Click the Download button.
 - c. In the dialog box, click **Open with** and then choose the desired program.
 - d. From the open program, save the file to a new path.
10. **Testing:**

- a. Using the Access Tester, enter an invalid user name and try to authenticate (see [Validating Connectivity and Policies Using the Access Tester](#)).
- b. In Fusion Middleware Control, go to the log viewer and review the error.
- c. Using the Access Tester, enter an invalid password and try to authenticate.
- d. In the Fusion Middleware Control log viewer, check the error and then view all related log messages.
- e. Repeat this test using different log levels, as described in "[Managing Log Level Changes in Fusion Middleware Control](#)".

See Also:

["About Finding, Viewing, and Exporting Log Messages "](#)

12.8 Displaying MBeans in Fusion Middleware Control

A Java object is a unit of code that runs the computer. Each object is an instance of a particular class or subclass that relies on the class's methods or procedures or data variables. Within the Java programming language, a Java object that represents a manageable resource (application, service, component, or device) is known as an MBean (managed bean).

Fusion Middleware Control enables you to:

- View information on key MBean Attributes and Operations
- Invoke methods

This section provides the following topics:

- [Fusion Middleware Control System MBean Browser](#)
- [Managing Mbeans](#)

12.8.1 Fusion Middleware Control System MBean Browser

The Fusion Middleware Control System Mbean Browser can be used to view System MBean Browser for Nodes and Targets.

[Table 12-11](#) details about the System MBean Browser..

Table 12-11 System MBean Browser

Node	Target	System Mbean Browser
Application Deployment	...AdminServer	Yes
Internal Applications	oamsso_logout(11.1.1.3.0)	Yes
	AdminServer	Yes
	oamsso_logout(11.1.1.3.0)	
	oam_server	

Table 12-11 (Cont.) System MBean Browser

Node	Target	System Mbean Browser
WebLogic Server domain	oam_bd (Cluster name)	Yes
	AdminServer	Yes
	oam_server	Yes
Identity and Access	OAM (Cluster)	No
	oam_server (Server)	Yes

Note:

Security Token Service MBeans are also available as described here.

Table 12-12 describes the MBeans that **Access Manager** and **Security Token Service** deploy on the AdminServer on the domain runtime server (OAM Server).

Table 12-12 MBeans that Access Manager and Security Token Service Deploy

MBeans For	Description
Configuration Service	oracle.oam:type=Config
Partner and Trust Service	oracle.oam:type=PATConfig
STS MBeans	oracle.sts:type=Config
Certificate Validation Module	These are used for CRL management. oracle.sts:type=CertRevocationListConfig

Figure 12-20 Shows the System MBean Browser and the related Attributes tab displaying information for the Security Token Service CertRevocationListConfig: `oracle.sts:Location=oam_server1,type=CertRevocationListConfig`.

Figure 12-20 System MBean Browser and Attributes Tab

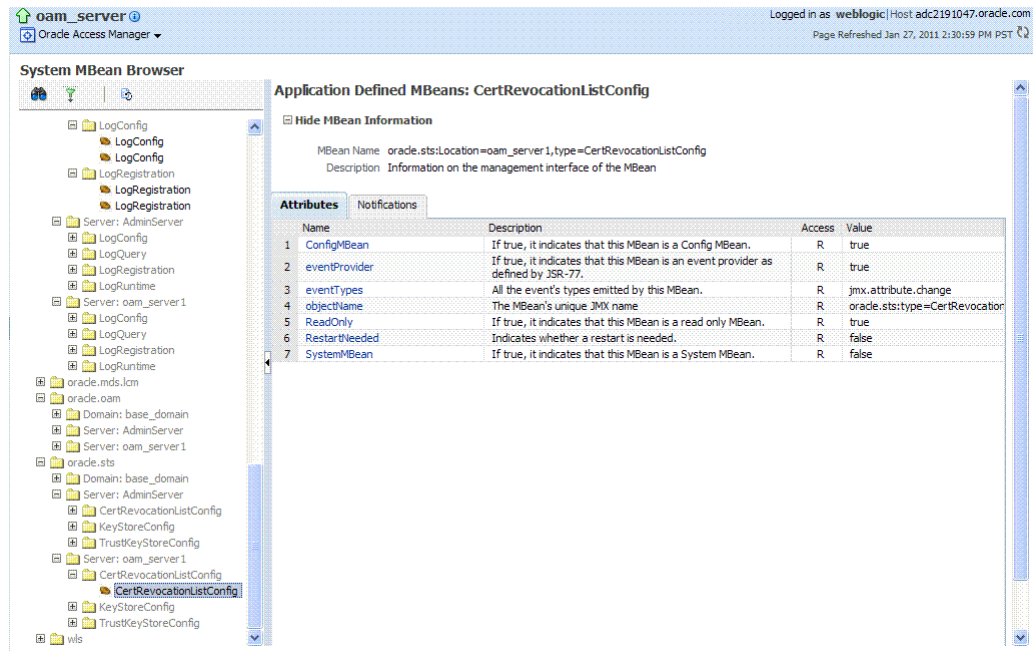
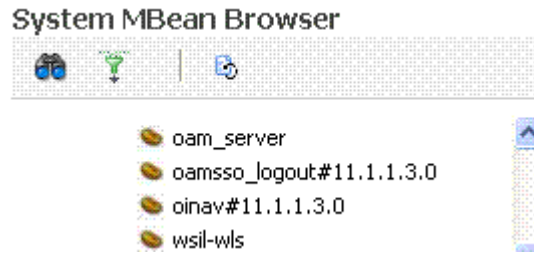

Table 12-13 describes the System MBean Browser and associated tab in greater details.

Table 12-13 System MBean Browser

System MBean Browser	Description
System MBean Browser	Expand items in this section to display Mbeans for the selected target. Under Application Defined Beans, find oracle.oam and oracle.sts.



MBean Information Details for Attributes and Operations related to the MBean for the selected target are displayed on the right.

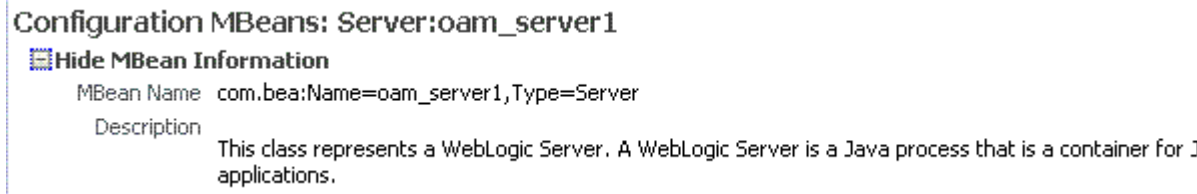
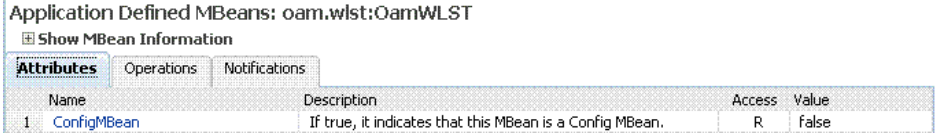
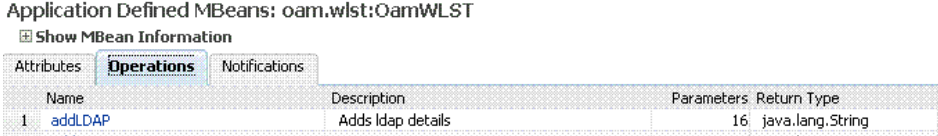

Table 12-13 (Cont.) System MBean Browser

System MBean Browser	Description
Attributes	<p>This tab describes MBean attributes for the selected target.</p> 
Operations	<p>This tab describes MBean operations for the selected target.</p> 
Notifications	<p>This tab lists any notifications resulting from the invocation of an MBean.</p>
Controls	<p>The following controls are available from these pages:</p> <ul style="list-style-type: none"> • Name Link: Clicking a name on either tab displays a full description of related MBeans. • Apply Button: Submits and applies the selected MBean attribute value. • Revert Button: Restores previous MBean attribute values following a change (and before clicking Apply). • Return Button: Returns you to the MBean Information page. • Invoke Button: Invokes the selected MBean and value

12.8.2 Managing Mbeans

Fusion Middleware Control Administrators can view, edit or invoke MBeans for **Access Manager** and **Security Token Service**. Additionally, you can apply values (or revert the change) and invoke MBeans.

1. Log in as described in "[Logging In To Fusion Middleware Control](#)".
2. Expand the desired node and select a target. For example:
 - Identity and Access
 - oam_server
3. From the Access Manager context menu, select **System MBean Browser**.
4. **System MBean Browser**: Expand classes and select an MBean target to display related attributes and operations. For example: **oracle.sts** or **oracle.oam**.
5. **Manage MBean Attributes**:
 - a. Click the Attributes tab.
 - b. Review the name and description of MBean attributes for the selected target.

- c. Edit values for one or more attributes and click Apply to submit changes (or click Revert to cancel changes).

Alternatively: Click a Name in the Attributes table to display a full description and the value; change the value and click Apply (or click Revert to cancel the change).

6. Manage MBean Operations:

- a. Click the **Operations** tab.
- b. Review the name, description, number of parameters, and return type for each MBean operation for the selected target.
- c. Click a name in the Operations table to display the parameters and related name, description, type, and value.
- d. Edit values for the operation and click Apply to submit changes (or click Revert to cancel changes).
- e. Click Invoke to invoke the MBean and review the message that appears.

Part IV

Managing Access Manager Settings and Agents

Administrators enable SSO across enterprise applications through agents registration and protect specific applications using Access Manager policies.

Administrators manage low-level Access Manager settings, agents, and sessions. This section contains the following chapters:

- [Configuring Access Manager Settings](#)
- [Introduction to Agents and Registration](#)
- [Registering and Managing OAM 11g Agents](#)
- [Maintaining Access Manager Sessions](#)

Configuring Access Manager Settings

The Access Manager Settings provide configuration options for a number of specific Access Manager service operations.

This chapter describes these Access Manager-specific settings.

- [Oracle Access Management Overview](#)
- [Managing Load Balancing](#)
- [Managing Secure Error Modes](#)
- [Managing SSO Tokens and IP Validation](#)
- [Managing the Access Protocol for OAM Proxy Simple and Cert Mode Security](#)
- [Managing Run Time Policy Evaluation Caches](#)

13.1 Oracle Access Management Overview

Familiarize with the Oracle Access Management, Serve registration and management before you start off with configuration options and service operations.

Be sure to review the following topics:

- [Getting Started with Oracle Access Management](#)
- [Managing Server Registration](#)

13.2 Managing Load Balancing

Configure two or more Managed Servers to operate as a cluster and use Oracle Access Management Console for Access Manager load balancing settings.

This section describes the following topics:

- [About Common Load Balancing Settings](#)
- [Managing OAM Server Load Balancing Settings](#)

13.2.1 About Common Load Balancing Settings

For production environments that require increased application performance, throughput, or high availability, you can configure two or more Managed Servers to operate as a cluster. A cluster is a collection of multiple WebLogic Server server instances running simultaneously and working together to provide increased scalability and reliability.

In a cluster, most resources and services are deployed identically to each Managed Server (as opposed to a single Managed Server), enabling failover and load balancing. A single domain can contain multiple WebLogic Server clusters and multiple

Managed Servers that are not configured as clusters. The key difference between clustered and non-clustered Managed Servers is support for failover and load balancing. These features are available only in a cluster of Managed Servers.

By default, Access Manager has a single OAM Server to which all login and logout requests are sent. In a high-availability deployment, you must change this setup so that login and logout requests are first sent to the load balancer.

See Also:

High Availability Guide, "Access Manager High Availability Configuration Steps" for high-level instructions to set up a high availability Access Manager deployment.

Figure 13-1 shows the Load Balancing Settings section of the Access Manager Settings page. In earlier releases this was part of the SSO Engine settings; the SSO Engine being the controller for sessions.

Figure 13-1 Access Manager Settings: Load Balancer

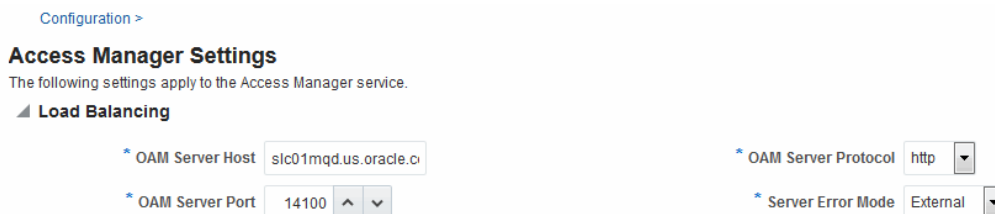

Table 13-1 describes each element and how it is used. Settings are global and common to all OAM Servers in the WebLogic administration domain.

Table 13-1 Access Manager Settings: Load Balancer

Element	Description
OAM Server Host	The virtual host name that represents the OAM Server Cluster, which might be exposed by a load balancer in front of an OAM Server Cluster.
OAM Server Port	The virtual host port associated with the OAM Server Cluster. Values between 1 and 65535 are supported.
OAM Server Protocol	The protocol, either HTTP or HTTPS, that is used to access the virtual host that represents the OAM Server Cluster. See Also: " About Security Modes and X509Scheme Authentication "

13.2.2 Managing OAM Server Load Balancing Settings

Users with valid Administrator credentials can modify Access Manager load balancing settings using Oracle Access Management Console.

See Also:

"[About Common Load Balancing Settings](#)"

1. From the Access Manager Settings, open Load Balancing:
2. Expand the Load Balancing area:
 - View Only: Close the page when you finish.
 - Modify: Edit Load Balancing settings for your deployment (Table 13-1).
3. Click Apply to submit the changes (or close the page without applying changes).
4. Dismiss the Confirmation window.

13.3 Managing Secure Error Modes

A custom error page is packaged as part of the custom login application. An out-of-the-box custom Web application archive file is provided that you can use as a starting point to develop customized login and password pages.

Server Error Mode settings are global and common to all OAM Servers in the WebLogic administration domain. This section provides the following topics:

- [OAM Server Error Modes](#)
- [Viewing or Editing OAM Server Secure Error Modes](#)

13.3.1 OAM Server Error Modes

The OAM Server Error Mode appears on the Load Balancing Settings area of the Access Manager Settings page.

Figure 13-1 shows the Server Error Mode function.

Figure 13-2 Access Manager Settings: Server Error Mode

Configuration >

Access Manager Settings

The following settings apply to the Access Manager service.

▲ Load Balancing

* OAM Server Host	<input type="text" value="slc01mqd.us.oracle.c"/>	* OAM Server Protocol	<input type="text" value="http"/>
* OAM Server Port	<input type="text" value="14100"/>	* Server Error Mode	<input type="text" value="External"/>

Table 13-2 describes the options you can choose to configure Server Error Mode for your deployment.

Table 13-2 Server Error Mode

Element	Description
Server Error Mode	<p>The setting you choose determines the nature of error messages and error codes returned by the OAM Server when an operation fails (because of an invalid username or password, for example, or a server error (connection to the LDAP Server is down)).</p> <p>Choose one of the following settings to configure error messages with varying degrees of security for your custom login pages:</p> <ul style="list-style-type: none"> SECURE: Most secure. Provides generic error messages that barely give any hint of the internal reason for the error. EXTERNAL: Recommended level. INTERNAL: Least secure level. Recommended for Password Policy validation, as described in "Managing Global Password Policy". OSSO10g: Compatible with OSSO 10g. Might be required in upgraded environments for consistency. <p>See Also: "Viewing or Editing OAM Server Secure Error Modes"</p>

[Table 13-3](#) shows the error triggering condition and message codes for each of the three modes.

Table 13-3 Error Trigger Condition, Modes, and Message Codes

Error Triggering Condition	Internal Mode	External Mode	Secure Mode
Invalid login attempt	OAM-1	OAM-2	OAM-8
Processing submitted credentials fails. For example: In WNA mode, the SPNEGO token is not received.	OAM-3	OAM-3	OAM-8
An authentication exception is raised.	OAM-4	OAM-4	OAM-9
User account gets locked based on certain conditions (exceeded invalid attempts, for instance).	OAM-5	OAM-5	OAM-8 OAM-9 with OIM integration
User account disabled.	OAM-5	OAM-5	OAM-9
User has exceeded the maximum number of allowed sessions (a configurable attribute).	OAM-6	OAM-6	OAM-9
Default error message, which is displayed when no other specific messages propagate up. This is not propagated to the user level. Cause could be multiple conditions.	OAM-7	OAM-7	OAM-9
Password expired.	OAM-10	OAM-10	OAM-9

[Table 13-4](#) identifies the error codes, trigger conditions, and recommended messages.

See Also:

Developing Custom Error Pages in the *Oracle Fusion Middleware Developer's Guide for Oracle Access Management*

Table 13-4 External Error Codes, Trigger Conditions, and Recommended Messages

External Error Code	Trigger Condition	Recommended Display Message
OAM-1	Invalid login attempts less than the allowed count.	An incorrect Username or Password was specified
OAM-2	Invalid login attempts less than the allowed count.	An incorrect Username or Password was specified
OAM-3	Processing submitted credentials fails for some reason. For example: in WNA mode, the SPENGO token is not received.	Internal Error.
OAM-4	An authentication exception is raised for some reason.	System error. Please contact the System Administrator.
OAM-5	The user account gets locked because of certain conditions (exceeded invalid attempts, for instance). OIM Integration. The Error page appears with contact details after the password is validated.	The user account is locked or disabled. Please contact the System Administrator.
OAM-5	The user account gets locked because of certain conditions (exceeded invalid attempts, for instance). OID Without OIM Integration: The Error page appears with contact details after the password is validated.	The user account is locked or disabled. Please contact the System Administrator.
OAM-5	The user account is disabled.	The user account is locked or disabled. Please contact the System Administrator.
OAM-6	The user has exceeded the maximum number of allowed sessions, which is a configurable attribute.	The user has already reached the maximum allowed number of sessions. Please close one of the existing sessions before trying to login again.
OAM-7	Failure could be due to multiple reasons; the exact reason is not propagated to the user level for security reasons. For instance: <ul style="list-style-type: none"> The request ID could have been lost The certificate is not retrieved correctly The default error message is displayed when no other specific messages are propagated up.	System error. Please re-try your action. If you continue to get this error, please contact the Administrator.
OAM-8	See Table 13-3	Authentication failed.
OAM-9	System error. Please re-try your action. If you continue to get this error, please contact the Administrator.	System error. Please re-try your action. If you continue to get this error, please contact the Administrator.

Table 13-4 (Cont.) External Error Codes, Trigger Conditions, and Recommended Messages

External Error Code	Trigger Condition	Recommended Display Message
OAM-10	Password expired.	The password has expired.

13.3.2 Viewing or Editing OAM Server Secure Error Modes

Users with valid Administrator credentials can view or edit Access Manager secure error mode settings for OAM Servers using the Oracle Access Management Console.

See Also:

["About Common Load Balancing Settings "](#)

To view or edit:

1. In the Configuration console, select **Access Manager** from the **View** menu in the **Settings** section.
2. On the Access Manager Settings page, expand the **Load Balancing** section.
3. Server Error Mode:
 - **Modify:** Choose the desired **Server Error Mode** for your deployment ([Table 13-2](#) and [Table 13-4](#)).
 - **View Only:** Close the page when you finish.
4. Click **Apply** to submit the changes (or close the page without applying changes).
5. Dismiss the Confirmation window.
6. Proceed to "[Managing SSO Tokens and IP Validation](#)".

13.4 Managing SSO Tokens and IP Validation

Use Oracle Access Management Console for modifying Access Manager SSO settings, IP Validation and SSO token version.

This section provides the following topics:

- [Access Manager SSO Tokens and IP Validation Settings](#)
- [Viewing or Editing SSO Tokens and IP Validation](#)

13.4.1 Access Manager SSO Tokens and IP Validation Settings

The Access Manager Settings page include information such as **IP Validation** and **SSO token version**.

[Figure 13-3](#) shows the SSO portion of the Access Manager Settings page. [Table 13-5](#) describes each element and how it is used.

Figure 13-3 Access Manager Settings: SSO



Table 13-5 Access Manager Settings: SSO

Element	Description
IP Validation	Specific to WebGates and is used to determine whether a client's IP address is the same as the IP address stored in the ObSSOCookie generated for single sign-on. Check the box to enable IP Validation. Clear the box to disable IP Validation if and only if IP Validation is disabled on all the configured WebGates. See IP Address Validation for WebGates .
SSO Token Version	Select your SSO token version from the list.

13.4.2 Viewing or Editing SSO Tokens and IP Validation

Users with valid Administrator credentials can view or edit Access Manager SSO settings using the Oracle Access Management Console.

See Also:

["About Common Load Balancing Settings "](#)

To view or edit:

1. In the Oracle Access Management Console, click **Configuration** at the top of the window.
2. In the Configuration console, select **Access Manager** from the **View** menu in the **Settings** section.
3. Expand the **SSO** section:
 - View Only: Close the page when you finish.
 - Modify: Perform remaining steps to edit the configuration.
4. Edit settings as needed for your deployment, based on details in [Table 13-5](#).
5. Click **Apply** to submit the changes (or close the page without applying changes).
6. Dismiss the Confirmation window.
7. Proceed to ["Managing the Access Protocol for OAM Proxy Simple and Cert Mode Security"](#).

13.5 Managing the Access Protocol for OAM Proxy Simple and Cert Mode Security

Configure secure server communication modes and manage through the settings for the common OAM Proxy.

This section describes the following topics:

- [OAM Proxy Simple and Cert Mode Transport Security](#)
- [Configuration Settings of Common OAM Proxy Page for Secure Server Communications](#)
- [Viewing or Editing Simple or Cert Settings for OAM Proxy](#)
- [Configuring 64-bit WebGate in Cert Mode](#)
- [Tuning the Simple Mode WebGate](#)

13.5.1 OAM Proxy Simple and Cert Mode Transport Security

Simple and Cert modes are similar.

[Table 13-6](#) outlines the similarities between Simple and Cert modes.

See Also:

[Securing Communication](#)

Table 13-6 Summary: Simple and Cert Mode

Artifact or Process	Simple Mode	Cert Mode	Open Mode
X.509 digital certificates only.	X	X	N/A
Communication between OAM Agents and OAM Servers is encrypted using Transport Layer Security, RFC 2246 (TLS v1).	X	X	N/A
For each public key there is a corresponding private key that Access Manager stores in a file:	aaa_key.pem generated by openssl	aaa_key.pem generated by your CA	N/A
Signed certificates in Privacy Enhanced Mail (PEM) format	aaa_cert.pem generated by openssl	aaa_cert.pem generated by your CA	N/A
During OAM Server configuration, secure the private key with a Global passphrase or PEM format details, depending on which mode you are using. Before an OAM Server or Webgate can use a private key, it must have the correct passphrase.	Global passphrase stored in a nominally encrypted file: <ul style="list-style-type: none"> • password.xml 	PEM format: <ul style="list-style-type: none"> • Keystore Alias • Key KEYSTOREStore Alias Password 	N/A
During OAM Agent or OAM Server registration, the communication mode is propagated to the Oracle Access Management Console.	Same passphrase for each Webgate and OAM Server instance.	Different passphrase for each Webgate and OAM Server instance.	N/A

Table 13-6 (Cont.) Summary: Simple and Cert Mode

Artifact or Process	Simple Mode	Cert Mode	Open Mode
<p>The certificate request for the Webgate generates the certificate request file, which you must send to a root CA that is trusted by the OAM Sever. The root CA returns the Webgate certificates, which can then be installed either during or after Webgate installation.</p>	<p>cacert.pem</p> <p>The certificate request, signed by the Oracle-provided openssl Certificate Authority</p>	<p>aaa_req.pem</p> <p>The certificate request, signed by the your Certificate Authority</p>	N/A
<p>Encrypt the private key using the DES Algorithm. For example:</p> <pre>openssl rsa -in aaa_key.pem - passin pass: -out aaa_key.pem - passout pass: <i>passphrase</i> -des</pre>	N/A	X	N/A
Agent Key Password	N/A	Enter a password during agent registration in Cert Security mode (see Table 15-1).	N/A
<p>During Agent registration, ObAccessClient.xml is generated in: \$DOMAIN_HOME/output/\$Agent_Name/</p>	<p>ObAccessClient.xml</p> <p>Copy to:</p> <p>11g Webgate: \$11gWebgate_instance_dir/config/OHS/ohs1/webgate/config</p> <p>If: \$11gWebgate_instance_dir=\$ORACLE_HOME/instance/instance1</p> <p>10g Webgate: \$Webgate_install_dir/oblix/lib</p>	<p>ObAccessClient.xml</p> <p>Copy to:</p> <p>11g Webgate: \$11gWebgate_instance_dir/...</p> <p>10g Webgate: \$Webgate_install_dir/...</p>	<p>ObAccessClient.xml</p> <p>Copy to:</p> <p>11g Webgate: \$11gWebgate_instance_dir/...</p> <p>10g Webgate: \$Webgate_install_dir/...</p>
<p>During Agent registration, password.xml is generated in: \$DOMAIN_HOME/output/\$Agent_Name/</p> <p>See Also: Securing Communication</p>	<p>password.xml</p> <p>Copy to:</p> <p>11g Webgate: \$11gWebgate_instance_dir/...</p> <p>10g Webgate: \$Webgate_install_dir/...</p>	<p>password.xml</p> <p>Copy to:</p> <p>11g Webgate: \$11gWebgate_instance_dir/...</p> <p>10g Webgate: \$Webgate_install_dir/...</p>	N/A

Table 13-6 (Cont.) Summary: Simple and Cert Mode

Artifact or Process	Simple Mode	Cert Mode	Open Mode
During Agent registration, aaa_key.pem is generated in: \$DOMAIN_HOME/output/\$Agent_Name/ See Also: Securing Communication	aaa_key.pem Copy to: 11g Webgate: \$11gWebgate_instance_dir... 10g Webgate: \$Webgate_install_dir..	aaa_key.pem Copy to: 11g Webgate: \$11gWebgate_instance_dir... 10g Webgate: \$Webgate_install_dir..	N/A

13.5.2 Configuration Settings of Common OAM Proxy Page for Secure Server Communications

You can the configure settings of Common OAM Proxy Page for Secure Server Communications.

[Table 13-7](#) describes the settings required for Simple or Cert mode configurations.

Table 13-7 Server Common OAM Proxy Secure Communication Settings

Mode	Description
Simple Mode Configuration	The global passphrase for communication using OAM-signed X.509 certificates. This is set during initial OAM Server installation. Administrators can edit this passphrase and then reconfigure all existing OAM Agents to use it, as described in " Viewing or Editing Simple or Cert Settings for OAM Proxy ".
Cert Mode Configuration	Details required for the Key KEYSTOREStore where the Cert mode X.509 certificates signed by an outside Certificate Authority reside: <ul style="list-style-type: none"> • PEM Keystore Alias • PEM Keystore Alias Password Note: These are set during initial OAM Server installation. The certificates can be imported using the import certificate utility or the keytool shipped with JDK. Administrators can edit the alias and password and then reconfigure all existing OAM Agents to use them, as described in " Viewing or Editing Simple or Cert Settings for OAM Proxy ".

13.5.3 Viewing or Editing Simple or Cert Settings for OAM Proxy

Administrators can use view or edit Simple or Cert mode settings for the common OAM Proxy.

See Also:

- ["Registering an OAM Agent Using the Console"](#)
 - ["Securing Communication "](#)
-
-

To view or edit:

1. In the Oracle Access Management Console, click **Configuration** at the top of the window.
2. In the Configuration console, select **Access Manager** from the **View** menu in the **Settings** section.
3. Expand the **Access Protocol** section.
4. **Simple Mode Configuration:** Add or alter a Global Passphrase if you are using OAM-signed X.509 certificates.
5. **Cert Mode Configuration:** Specify the following details.
 - PEM Keystore Alias
 - PEM Keystore Alias Password
6. Click **Apply** to submit the changes and dismiss the Confirmation window (or close the page without applying changes).
7. Update Agent registration pages as needed to regenerate artifacts, and then replace the earlier artifacts as described in [Introduction to Agents and Registration](#) or [Registering and Managing OAM 11g Agents](#) .

13.5.4 Configuring 64-bit WebGate in Cert Mode

64-bit WebGates now support SHA2 (256,384 & 512 bit) certificates.

Run the following command to configure a 64-bit WebGate in cert mode.

```
<Oracle Middleware Home>/oracle_common/bin/orapki wallet add
-wallet $DOMAIN_HOME/output/$Agent_Name/cwallet.sso -trusted_cert
-cert <Root CA path .i.e. aaa_chain.pem> -auto_login_only
```

13.5.5 Tuning the Simple Mode WebGate

If using a simple mode WebGate, you can improve the response time of the OAM login page by changing the `aaaTimeoutThreshold` time parameter in the WebGate profile from -1 to 10.

For detailed information about the AAA Timeout Threshold configuration element, see [Table 15-3](#) in [Registering and Managing OAM 11g Agents](#) .

13.6 Managing Run Time Policy Evaluation Caches

Access Manager common run time policy evaluation cache settings are managed by administrators and policy evaluation caches are required during policy evaluation at run time.

This section describes the following topics:

- [Settings for Run Time Policy Evaluation Caches](#)
- [Managing Run Time Policy Evaluation Caches](#)

See Also:

["Run Time Resource Evaluation "](#)

13.6.1 Settings for Run Time Policy Evaluation Caches

The Resource Matching Cache and the Authorization Result Cache are set and required during policy evaluation at run time.

Figure 13-4 illustrates the Policy section of the Access Manager Settings page.

Figure 13-4 Common Policy Evaluation Caches

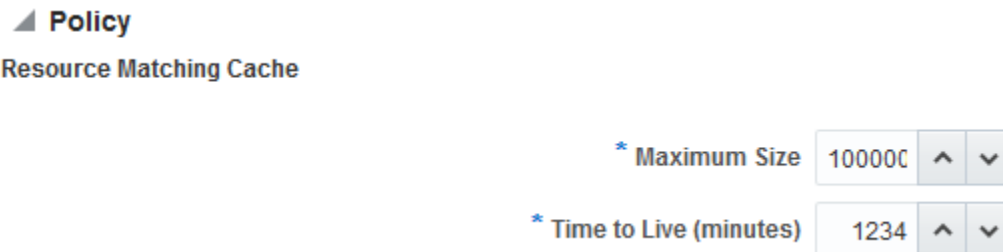

Table 13-8 outlines these global settings that apply to all servers and requests.

Table 13-8 Policy Evaluation Caches

Element	Description
Resource Matching Cache	<p>Caches mappings between the requested URL and the policy holding the resource pattern that applies to the URL.</p> <p>Default Values:</p> <ul style="list-style-type: none"> Maximum Size 100000 Zero disables the cache Time to Live (seconds) 3600 Zero disables Time to Live
Authorization Result Cache	<p>Caches policy decisions for the requested URL and user.</p> <p>Default Values:</p> <ul style="list-style-type: none"> Maximum Size 100000 Zero disables the cache Maximum Size per User 100 Zero disables the cache Time to Live (seconds) 3600 Zero disables Time to Live <p>See Also: <i>Tuning Performance</i></p>

13.6.2 Managing Run Time Policy Evaluation Caches

Administrators manage the Access Manager common run time policy evaluation cache settings.

1. In the Oracle Access Management Console, click **Configuration** at the top of the window.
2. In the Configuration console, select **Access Manager** from the **View** menu in the **Settings** section.
3. Expand the **Policy** section.
4. **Resource Matching Cache:** Specify details and click apply (Table 13-8).
5. **Authorization Result Cache:** Specify details and click apply (Table 13-8).
6. Click **Apply** to submit the changes and dismiss the Confirmation window (or close the page without applying changes).

See Also:

- *High Availability Guide*
 - *Tuning Performance*
-
-

Introduction to Agents and Registration

An agent (also known as a single sign-on agent or policy-enforcement agent) is any front-ending entity that acts as an access client to enable single sign-on across enterprise applications.

Individual agents must be registered with Access Manager 11g to set up the required trust mechanism between the agent and OAM Server. Registered agents delegate authentication tasks to the OAM Server.

This chapter includes the following topics to give you an overview of agents, their registration and management, processing, and tools.

- [Introduction to Policy Enforcement Agents](#)
- [Introduction to Agent Registration](#)
- [OAM Remote Registration](#)

14.1 Introduction to Policy Enforcement Agents

An agent is a software plug-in that can be installed on a Web server (such as Oracle HTTP Server) where the application resides. To secure access to protected resources, a Web server, Application Server, or third-party application must be associated with an agent that is registered with Access Manager. To spare users from re-authenticating when accessing multiple resources, the application delegates the authentication function to the single sign-on (SSO) provider: Access Manager.

During agent registration, the application can be automatically registered and basic policies automatically generated. Alternatively, you can turn off automatic policy generation during Agent registration and manually create policies.

After registration, the Agent acts as a filter for HTTP/HTTPS requests, communicating between the OAM Server and its services. The Agent intercepts requests for resources protected by Access Manager and works with Access Manager to fulfill access requirements. The following sections introduce the types of agents.

- [Agent Types and Runtime Processing for OAM Agents](#)
- [About 11g WebGate Configured as a Detached Credential Collector](#)
- [About 11g WebGate Functionality for Mobile and Social](#)
- [About the Pre-Registered 10g WebGate IAMSuiteAgent](#)

14.1.1 Agent Types and Runtime Processing for OAM Agents

With Access Manager 11.1.2, each Agent acts as a filter for requests.

Your deployment can include the agent types described in [Table 14-1](#), in any combination.

Table 14-1 Agent Types

Agent Type	Description
<p>OAM Agents</p> <p>Note: Unless explicitly stated, the terms Webgate and Access Client are used interchangeably.</p>	<p>OAM Agents must be installed independently, following Oracle Access Management installation. After registering the agent with Access Manager, the agent communicates directly with registered OAM Servers and Access Manager services. OAM Agents communicate with Access Manager using the OAM Proxy to "sanitize" the request and respond identically for all agents. The following OAM Agents types are available:</p> <ul style="list-style-type: none"> • Webgate: An out of an box Web server access client that intercepts HTTP requests for Web resources and forwards these to the OAM Server. WebGates for various Web servers are shipped with Access Manager. <ul style="list-style-type: none"> – 11g WebGates (Registering and Managing 10g WebGates with Access Manager 11g) provide: <ul style="list-style-type: none"> Oracle Universal Installer for platform Host-based cookie Individual WebGate OAMAuthnCookie_<host:port> Resource to Authorization Policy Authorization Result Webgate Authorization Caching Diagnostic page to tune parameters Capability to act as a detached credential collector • See Also: <ul style="list-style-type: none"> "About 11g WebGate Functionality for Mobile and Social " "About 11g WebGate Configured as a Detached Credential Collector" <i>Tuning Performance</i> – 10g WebGates provide: <ul style="list-style-type: none"> InstallShield and One installer per platform Domain-based cookie ObSSOCookie (one for all 10g WebGates) Web server configuration • See Also: 10g Pre-registered IAMSuiteAgent in this table and Registering and Managing 10g WebGates with Access Manager 11g • Custom, Programmatic Access Clients: Access Manager provides a pure Java software developer kit (SDK). Use this SDK to create custom Access Clients and extensions for Access Manager authentication and authorization functionality (and custom tokens). An Access Client processes requests for Web and non-Web resources (non-HTTP) from users or applications. See details in the <i>Oracle Fusion Middleware Developer's Guide for Oracle Access Management</i>.
<p>IAMSuite Agent</p> <p>a Pre-registered OAM 10g Agent</p>	<p>This pre-registered 10g agent provides single sign-on functionality for the IAM suite of consoles. The IAM Suite Agent includes a companion Application Domain (IAMSuite) and basic policies that should not be modified.</p> <p>See Also: About the Pre-Registered 10g WebGate IAMSuiteAgent</p>

Table 14-1 (Cont.) Agent Types

Agent Type	Description
Legacy OSSO Agents	<p>mod_osso is part of the OracleAS 10g single sign-on (OSSO) solution that authenticates users at a central OSSO Server. The mod_osso module is an Oracle HTTP Server module that provides authentication to OracleAS applications.</p> <p>After registration with Access Manager, OSSO 10g Agents communicate directly with Access Manager 11g services through an OSSO proxy. The OSSO proxy supports existing OSSO agents when upgrading to Access Manager. The OSSO proxy handles requests from OSSO Agents and translates the OSSO protocol into a protocol for Access Manager 11g authentication services.</p> <p>Access Manager gives mod_osso the redirect URL for the user based on the authentication scheme associated with the OAM policy defined for the resource</p> <p>See Also: Registering and Managing Legacy OSSO Agents as well as the following topics:</p>
Legacy OpenSSO Agents	<p>Java Agents are deployed J2EE containers to work with the OpenSSO server. Web Agents can be deployed on any Web or Servlet container. Each OpenSSO Agent is a filter that is plugged into the container (Oracle WebLogic Server, JBoss, Apache, and so on) that hosts applications.</p> <p>Access Manager provides an OpenSSO Proxy to handle requests for resources protected by OpenSSO Agents:</p> <ul style="list-style-type: none"> • Scope can be Host- or Domain-based • OpenSSO Agent key stored locally (Agent bootstrap file, Agent host) <p>See Also: Registering and Managing Legacy OpenSSO Agents .</p>

Table 14-2 introduces Access Manager features that support agent registration, configuration, management, and single-sign on. Links to topics providing more information are included.

Table 14-2 Agent Registration and SSO Support

Oracle Provides	Description
Oracle Access Management Console	<p>Agent Registration, Configuration, Management.</p> <p>See Also: "Registering an OAM Agent Using the Console"</p>
oamreg tool	<p>Remote Agent Registration and Management</p> <p>See Also: "Acquiring and Setting Up the Remote Registration Tool".</p>
SSO Implementations	<p>Access Manager supports numerous SSO scenarios.</p> <p>See Also: "Access Manager Single Sign-On Components"</p>
Protocols that secure information exchange on the Internet	<p>This depends on the credential collector you choose.</p> <p>See Also: Table 22-5</p>
Login and Logout Forms	<p>The location of the login and logout forms depends on the credential collector.</p> <p>See Also: Table 22-5 and Configuring Centralized Logout for Sessions Involving 11g WebGates</p>

Table 14-2 (Cont.) Agent Registration and SSO Support

Oracle Provides	Description
Cryptographic keys	One key is generated and used per registered mod_osso or 11g Webgate. However, one single key is generated for all 10g Webgates. See Also: Table 1-2
Keys storage	<ul style="list-style-type: none">• Agent side: A per agent key is stored locally in the Oracle Secret Store in a wallet file.• OAM Server side: A per agent key, and server key, are stored in the credential store on the server side.

[Table 14-3](#) provides run time processing information for OAM Agents.

See Also:

["Understanding Credential Collection and Login "](#)

Table 14-3 Run Time Processing Overview for Access Manager

Agent Type	Description
11g Web Gates 11g Access Clients	<p>After installation and registration, 11g WebGates communicate with Access Manager using the OAM Proxy to "sanitize" the request and respond identically for all agents.</p> <p>Process overview, Authentication Request without OAMAuthnCookie: When a request for a resource protected by Basic authentication scheme comes without an authorization header (credentials)</p> <ol style="list-style-type: none"> 1. WebGate redirects through the front channel to either Embedded or Detached Credential Collector (depending on scheme configuration) to collect credentials. 2. Credential Collector collects user credentials based on the challenge method defined for the authentication scheme. 3. User is authenticated; OAM Proxy (Embedded Collector) or Detached Collector itself (DCC) communicates with the OAM Server through the back channel protocol for the token and returns a response through the front channel with a token issued by the OAM Server. 4. WebGate validates the response, extracts the authentication token issued by the OAM Server, and sets a token in OAMAuthnCookie. 5. WebGate is redirected to the requested resource, with the newly set OAMAuthnCookie attached. 6. WebGate validates the OAMAuthnCookie, performs authorization through the back channel, and serves the page when authorization is successful. <p>Process overview, Basic Authentication: When a request for a resource protected by Basic authentication scheme comes without an authorization header (credentials)</p> <ol style="list-style-type: none"> 1. WebGate responds with <code>WWW-Authenticate</code> header containing the realm mentioned in the authentication scheme with status code 401 (<code>authorization required</code>). 2. Browser client interprets the <code>WWW-Authenticate</code> header and collects credentials from user. 3. Browser client performs request again with authorization header containing credentials.
See Also:	<p>"About 11g WebGate Configured as a Detached Credential Collector"</p> <p>"About 11g WebGate Functionality for Mobile and Social "</p>

Table 14-3 (Cont.) Run Time Processing Overview for Access Manager

Agent Type	Description
10g WebGates	After installation and registration, 10g WebGates communicate directly with Access Manager using the OAM proxy, which acts as a bridge. See Also:
10g Access Clients	<ul style="list-style-type: none"> • IAMSuiteAgent for details about this agent and Application Domain. • Registering and Managing 10g WebGates with Access Manager 11g for details about registering legacy 10g WebGates with Access Manager. • Integrating Oracle ADF Applications with Access Manager SSO for details about legacy 10g WebGates currently operating with Web Applications coded for Oracle ADF Security and the OPSS SSO Framework. • Securing Applications with Oracle Platform Security Services for details about legacy 10g Webgates configured as the Identity Assertion Provider (IAP) for SSO (for applications using WebLogic container-based security with Access Manager 11g (or Oracle Access Manager 10g).
Open SSO Agents	See Also: " Runtime Processing Between OpenSSO Agents and Access Manager ".
OSSO Agent (mod_osso 10g)	See: " Understanding OSSO Agents with Access Manager ".

14.1.2 About 11g WebGate Configured as a Detached Credential Collector

With Oracle Access Manager 11.1.1, the Embedded Credential Collector (ECC) is the default. The ECC was and is integrated with the OAM Server.

Access Manager 11.1.2 also supports the ECC by default. However, Access Manager 11.1.2 also enables you to configure an 11g WebGate to use a detached credential collector (DCC). The DCC is considered more secure when compared to the default ECC.

An 11g WebGate configured to act as a DCC is known as an Authenticating WebGate. WebGates that protect resources are known as Resource WebGates.

See Also:

["Configuring 11g WebGate and Authentication Policy for DCC"](#)

14.1.3 About 11g WebGate Functionality for Mobile and Social

WebGates interact with the client to perform authentication and authorization; this involves redirection to collect credentials, set the cookie to hold the session, report errors, and so on. WebGates work with browser clients, which usually have all the support required for this interaction end to end.

However, there are cases where a non-browser client making REST calls directly needs to access resources and perform authentication and authorization. This use case can be addressed with Mobile and Social.

Mobile and Social support is enabled using two user-defined parameters within the WebGate agent registration page. Mobile and Social services use a programmatic non-browser client with Access Manager. For details, see the following documentation.

- [Managing Oracle Access Management Mobile and Social](#)
- *Oracle Fusion Middleware Developer's Guide for Oracle Access Management*

14.1.4 About the Pre-Registered 10g WebGate IAMSuiteAgent

The 10g WebGate and the companion Application Domain provides single sign-on functionality for the IDM Administration Console. IAMSuiteAgent is installed and pre-configured for this purpose as part of the initial OAM Server installation and configuration.

Oracle strongly recommends that you do not alter IAMSuiteAgent and the companion Application Domain. However, you can replace the IAMSuiteAgent with a fresh 10g WebGate. For details, see the following sections.

- ["Replacing the IAMSuiteAgent with an 11g WebGate"](#)
- ["Configuring Centralized Logout for IAMSuiteAgent"](#)
- ["Bundled 10g IAMSuiteAgent Artifacts"](#)

14.2 Introduction to Agent Registration

You can use either the Oracle Access Management Console or the remote registration tool for Agent registration and updates. Unless explicitly stated, information in this section applies to agent registration using either of these tools.

This section provides the following details.

- [Keys and Policies Generated during Agent Registration](#)
- [File System Changes and Artifacts for Registered Agents](#)

14.2.1 Keys and Policies Generated during Agent Registration

Administrators must register each Agent to operate with Access Manager. Only registered agents can communicate with an OAM Server, and process information for a user attempting to access a protected resource.

The agent is presumed to reside on the computer hosting the application to be protected. However, it can reside on a proxy Web server and the application on a different host.

An agent key and partner key are created during registration. You can also create policies to protect the application during agent registration. If you choose to automatically create policies during agent registration, a host identifier and Application Domain are created with basic policies and resource definitions. Later on, you can view and manage the Application Domain and policies.

Note:

You can register multiple WebGates or Access Clients under a single host identifier, with the same Application Domain and policies, as follows:

1. When you register a WebGate, allow the process to create a host identifier (a name of your choice), and enable "Auto Create Policies".
2. Register a second WebGate with the same host identifier as Step 1, and clear the "Auto Create Policies" box to eliminate policy creation.

Following a successful registration (using either the console or remote registration tool), the full agent registration appears in the Oracle Access Management Console and is propagated to all Managed Servers in the cluster. [Table 14-4](#) identifies the keys and policies generated during agent registration.

Table 14-4 Keys and Policies Generated During Agent Registration

Keys and Policies	Accessible to	Accessible through
One key per 11g WebGate Agent One key for all 10g Agents One key per OpenSSO Agent stored in local Agent bootstrap file One key per OSSO Agent See Also: " Key Use, Generation, Provisioning, and Storage "	<ul style="list-style-type: none"> • OAM Server 	<ul style="list-style-type: none"> • Client-side: Secure local storage on the client host (a local wallet file) • Server side: The Java Keystore
Partner key for the application (None for OpenSSO Agents)	<ul style="list-style-type: none"> • 11g WebGate 	Client-side
Application Domain and default Policies are generated during Agent registration on demand: <ul style="list-style-type: none"> • Named for the Agent • Populated with default authentication and authorization policies (but not Token Issuance Policies) • Identified by the same host identifier that was specified for the Agent during registration 	<ul style="list-style-type: none"> • Administrators can view, modify, or remove a registered agent using either the Oracle Access Management Console or custom WLST commands for Access Manager • All agent types at run time monitor attempts to access a Web site and use OAM Servers to provide authentication and authorization services before completing the request 	Oracle Access Management Console Policy Configuration Application Domains <i>DomainName</i>

14.2.2 File System Changes and Artifacts for Registered Agents

When you register an agent using the Oracle Access Management Console, a new file system directory is created for the Agent on the Oracle Access Management Console host (AdminServer).

This new directory includes generated files for the registered agent, as described in [Table 14-5](#).

Table 14-5 Artifacts Associated with Agent Registration

Registration Artifact	Generated for ...
All WebGates or Access Client ObAccessClient.xml	All WebGates/ Access Clients on the console host (AdminServer). During run time, periodic update checks are made. ObAccessClient is updated automatically when a change is discovered. Note: The pre-registered 10g IAMSuiteAgent does not use ObAccessClient.xml for bootstrap or configuration. See Also: Properties files generated on the client in this table.
cwallet.sso <i>11g WebGate only</i>	11g WebGates, regardless of the transport security mode.
Certificate and password files for secure communication	All WebGates/ Access Clients. For example: <ul style="list-style-type: none"> password.xml (nominally encrypted file for Simple Mode Global passphrase) aaa_cert.pem (reserved name for WebGate certificate file, which cannot be changed) aaa_key.pem (reserved name for WebGate key file, which cannot be changed) Cert Mode: <ul style="list-style-type: none"> PEM keystore Alias PEM keystore Alias Password Note: When editing an 11g WebGate registration, password.xml is updated only when the mode is changed from Open to Cert or Simple to Cert. In Cert mode, once generated, password.xml cannot be updated. Editing the agent Key Password does not result in creation of a new password.xml. See: Configuring Access Manager Settings for details about Simple and Cert mode transport security)
OpenSSO Properties files	See: Registering and Managing Legacy OpenSSO Agents
osso.conf file	See: Registering and Managing Legacy OSSO Agents

Generated or updated artifacts must be copied from the console host (AdminServer) into the agent's installation directory, as shown in [Table 14-6](#).

Table 14-6 Copying Generated Artifacts

Agent Type & Artifacts	Copy Generated Artifacts to Agent Installation Directory ...
ObAccessClient.xml (and 11g WebGate cwallet.sso) 11g WebGate or Access Client	Before agent startup, copy the ObAccessClient file (and cwallet.sso) from the generated location (AdminServer (Console) host) to the agent installation directory. See: Registering and Managing OAM 11g Agents
ObAccessClient.xml 10g WebGate or Access Client	Before agent startup, copy ObAccessClient.xml from the generated location to the agent installation directory. For example, from the AdminServer (Console) host: Note: The pre-registered IAMSuiteAgent does not use ObAccessClient.xml and should not be modified. See: Registering and Managing 10g WebGates with Access Manager 11g
OpenSSO Agent Properties Files	See: Registering and Managing Legacy OpenSSO Agents

Table 14-6 (Cont.) Copying Generated Artifacts

Agent Type & Artifacts	Copy Generated Artifacts to Agent Installation Directory ...
10g OSSO Agent osso.conf	See: Registering and Managing Legacy OSSO Agents

14.3 OAM Remote Registration

As an alternative to using the Console for agent registration, you can use the remote registration utility, `oamreg`, with Oracle-provided templates.

The user of the remote registration script can be a part of any group that is mapped against the Administrator's Role in the primary user-identity store for Access Manager ([Managing Data Sources](#)).

Secure registration and creation of an Application Domain (as well as Symmetric key generation) is supported using either remote registration mode described in [Table 14-7](#).

Table 14-7 Remote Registration Methods

Method	Description
In-band mode	For Administrators within the network who manage the Web server that hosts the agent can use this mode or the Oracle Access Management Console.
Out-of-band mode	Administrators outside the network must submit registration requests to an Administrator within the network. After processing the request, the in-band Administrator returns the files required by the out-of-band Administrator who uses the files to configure his environment.

Symmetric key generation per Application: One key is generated and used per registered `mod_osso` or 11g WebGate. However, one single key only is generated for all 10g WebGates.

Note:

Registration of legacy Agents (10g WebGate, OpenSSO, and OSSO 10g) is also supported.

The functionality that are not supported with remote registration are as follows:

- Persistence of the Key and Agent Information
- Generation of Keys used by internal components
- API support for reading Agent information

For more information on the registration modes, see the following sections:

- [Performing In-Band Remote Registration](#)
- [Performing Out-of-Band Remote Registration](#)
- [Updating Agent Configuration Files](#)

[Registering and Managing OAM 11g Agents](#) has additional details.

14.3.1 Performing In-Band Remote Registration

Using the remote registration tool, an in-band Web server Administrator can perform tasks for provisioning an application. Unless explicitly stated, tasks are the same regardless of the type of agent you have protecting resources.

In this overview, the term "Administrator" refers to any user within the network who is part of the LDAP group that is designated for Administrators in the Default System User Identity Store registered with Oracle Access Management.

1. Acquire the registration tool as described in "[Acquiring and Setting Up the Remote Registration Tool](#)".
2. Update the input file with unique values for the agent and Application Domain as described in "[Creating Your Remote Registration Request](#)".
3. Run the registration tool to configure the Agent and create a default Application Domain for the resources, as described in "[Performing In-Band Remote Registration](#)".
4. Validate the configuration as described in "[Validating Remote Registration and Resource Protection](#)".
5. Perform access checks to validate that the configuration is working, as described in "[Verifying Authentication and Access After Remote Registration](#)".

14.3.2 Performing Out-of-Band Remote Registration

The term *out-of-band registration* refers to manual registration that involves coordination and actions by both the in-band Administrator and the out-of-band Administrator.

Following is a brief overview of out-of-band remote registration (when the Agent is outside the network).

1. **Out-of-band Administrator:** Creates a starting request input file containing specific application and agent details and submits it to the in-band Administrator.
 - Acquire the registration tool as described in "[Acquiring and Setting Up the Remote Registration Tool](#)".
 - Copy and edit a template to input unique values for the agent and Application Domain as described in "[Creating Your Remote Registration Request](#)".
 - Submit the starting request input file to the in-band Administrator using a method you choose (email or file transfer).
2. **In-band Administrator:**
 - Acquire the registration tool as described in "[Acquiring and Setting Up the Remote Registration Tool](#)".
 - Use the out-of-band starting request with the registration tool to provision the agent and create the following files to return to the out-of-band Administrator. See "[Performing Out-of-Band Remote Registration](#)" for details:
 - *agentName_Response.xml* is generated for the out of band Administrator to use in Step 3.

- OAM Agents: A modified ObAccessClient.xml file is created (and the 11g WebGate cwallet.sso file), which the out-of-band Administrator can use to bootstrap the WebGate.
11g WebGates: SSO wallet creation.
- OSSO Agents: A modified osso.conf file is created for the out-of-band Administrator to bootstrap the OSSO module.
- OpenSSO Agents: A modified version of the OpenSSO properties files are generated.

3. **Out-of-band Administrator:** Uses the registration tool with the *agentName_Response.xml* file and copies the Agent configuration and any other generated artifacts to the appropriate file system directory.

Note:

In outofband mode, the in-band Administrator uses the starting request file submitted by the out-of-band Administrator, and returns a generated *agentName_Response.xml* file to the out-of-band Administrator for additional processing. The out-of-band Administrator runs the remote registration tool with *agentName_Response.xml* as input to generate agent configuration files.

4. **In-band Administrator:** Validates the configuration as described in "[Validating Remote Registration and Resource Protection](#)".
5. **Out-of-band Administrator:** Performs several access checks to validate that the configuration is working, as described in "[Verifying Authentication and Access After Remote Registration](#)".

See Also:

- "[Updating Agent Configuration Files](#)"
 - "[Remote Registration Tool, Modes, and Process](#)"
-
-

14.3.3 Updating Agent Configuration Files

After a successful registration (or update), you must locate the Agent configuration files on the AdminServer (console) host and copy these to the Agent host.

The artifacts for Agent's registration or update are described in [Table 14-8](#).

Table 14-8 Agent Registration and Configuration Update Artifacts

Artifacts For ...	Description
Simple or Cert mode	If Simple or Cert mode is used, certificate artifacts must also be copied to the Agent host following registration. See Also: Securing Communication

Table 14-8 (Cont.) Agent Registration and Configuration Update Artifacts

Artifacts For ...	Description
11g OAM Agents (WebGate/Access Client)	See Also: Registering and Managing OAM 11g Agents
10g OAM Agents (WebGate/Access Client)	See Also: Registering and Managing 10g WebGates with Access Manager 11g
OSSO Agent	See Also: Registering and Managing Legacy OSSO Agents
OpenSSO Agent	See Also: Registering and Managing Legacy OpenSSO Agents

Registering and Managing OAM 11g Agents

You can register and manage 11g WebGates (and the programmatic equivalent, Access Clients) using either the Oracle Access Management Console or the remote registration command-line utility. During registration, you can identify specific applications to be protected by Access Manager policies.

The following topics describe how to register and manage OAM 11g Agents:

- [Before Registering and Managing Agents](#)
- [OAM Agent Registration Parameters in the Console](#)
- [Registering an OAM Agent Using the Console](#)
- [Configuring and Managing Registered OAM Agents Using the Console](#)
- [Remote Registration Tool, Modes, and Process](#)
- [Remote Registration Templates: OAM Agents](#)
- [Performing Remote Registration for OAM Agents](#)
- [Remote Agent Update Modes and Templates](#)
- [Updating Agents Remotely](#)
- [Validating Remote Registration and Resource Protection](#)
- [Replacing the IAMSuiteAgent with an 11g WebGate](#)
- [Managing the Preferred Host in 10g WebGates](#)

15.1 Before Registering and Managing Agents

Ensure that the Oracle Access Management Console host (AdminServer) and a managed OAM Server are running.

See Also:

The following, as needed for your environment.

- [Introduction to Agents and Registration](#)
 - [Managing Policies and Application Domains Remotely](#)
 - [Registering and Managing Legacy OpenSSO Agents](#)
 - [Registering and Managing Legacy OSSO Agents](#)
 - [Registering and Managing 10g WebGates with Access Manager 11g](#)
-
-

15.2 OAM Agent Registration Parameters in the Console

Unless explicitly stated, the information here applies equally to both 11g and 10g WebGates, including programmatic Access Clients.

OAM Agent registration parameters topics include:

- [Creating OAM WebGate Page and Parameters](#)
- [User-Defined WebGate Parameters](#)
- [IP Address Validation for WebGates](#)

15.2.1 Creating OAM WebGate Page and Parameters

The `Create OAM ... WebGate` page requests minimal information to streamline registration.

Required details are identified by the asterisk (*). Whether you register an 11g WebGate or 10g WebGate, the initial information requested is the same.

Figure 15-1 Create OAM 11g WebGate Page

Access Manager >

Create Webgate

Use the following screen to register an OAM Agent. Before you register, ensure that at least one OAM Server is running in the same mode as the Agent to be registered.

*** Version**

*** Name**

Description

Base URL

Access Client Password

Host Identifier

User Defined Parameters

*** Security** Open
 Simple
 Cert

Virtual host

Auto Create Policies

IP Validation

Resource Lists

Protected Resource List Add Delete

Relative URI

Public Resource List Add Delete

Relative URI

Table 15-1 describes the Create page for 11g WebGates (or Access Clients).

Unless explicitly noted, all elements apply to both 11g and 10g Agents.

Table 15-1 Elements on Create Pages for 11g and 10g OAM Agents

OAM WebGate Element	Description
Version	Specifies whether this will be a 10g or an 11g WebGate.
Name	<p>The unique identifying name for this Agent registration. This is often the name of the computer that is hosting the Web server used by WebGate.</p> <p>A unique identifying name for each Agent registration is preferred. However:</p> <ul style="list-style-type: none"> If the Agent Name exists, no error occurs and the registration does not fail. Instead, Access Manager creates the policies if they are not already in place. If the host identifier exists, the unique Agent Base URL is added to the existing host identifier and registration proceeds.
Description	A meaningful description of this Agent registration.

Table 15-1 (Cont.) Elements on Create Pages for 11g and 10g OAM Agents

OAM WebGate Element	Description
Base URL Optional	<p>The host and port of the computer on which the Web server for the WebGate is installed. For example, <code>http://example_host:port</code> or <code>https://example_host:port</code>. The port number is optional.</p> <p>Note: A particular Base URL can be registered once only. There is a one-to-one mapping from this Base URL to the Web server domain on which the WebGate is installed (as specified with the Host Identifier element). However, one domain can have multiple Base URLs.</p>
Access Client Password Optional	<p>An optional, unique password for this WebGate, which can be assigned during this registration process.</p> <p>When a registered WebGate connects to an OAM Server, the password is used for authentication to prevent unauthorized WebGates from connecting to OAM Servers and obtaining policy information.</p>
Security	<p>Level of communication transport security between the Agent and the OAM Server (this must match the level specified for the OAM Server):</p> <ul style="list-style-type: none"> • Open--No transport security • Simple--SSL v3/TLS v1.0 secure transport using dynamically generated session keys • Cert--SSL v3/TLS v1.0 secure transport using server side x.509 certificates. Choosing this option displays a field where you can enter the Agent Key Password. <p>Agent Key Password: The private key file (<code>aaa_key.pem</code>) is encrypted using DES algorithm. The Agent Key Password is saved in obfuscated format in <code>password.xml</code> and is required by the server to generate <code>password.xml</code>. However, this password is not retained by the server. When editing an 11g WebGate registration, <code>password.xml</code> is updated only when the mode is changed from Open to Cert or Simple to Cert. In Cert mode, once generated, <code>password.xml</code> cannot be updated. Editing the Agent Key Password does not result in creation of a new <code>password.xml</code>.</p> <p>Note: For more information on Simple and Cert modes, and private key encryption, see Securing Communication.</p>
Host Identifier	<p>This identifier represents the Web server host. This is automatically seeded with the value in the agent Name field.</p> <p>Note: You can register multiple OAM WebGates (or Access Clients) under a single host identifier with the same Application Domain and policies, as follows:</p> <ol style="list-style-type: none"> 1. When you register a WebGate, allow the process to create a host identifier (a name of your choice), and enable "Auto Create Policies". 2. Register a second WebGate with the same host identifier as Step 1, and clear the "Auto Create Policies" box to eliminate policy creation. <p>See Also: "About Virtual Web Hosting".</p>
User-defined Parameters	<p>Parameters you can enter to enable specific WebGate behaviors:</p> <p>See Also: "User-Defined WebGate Parameters".</p>

Table 15-1 (Cont.) Elements on Create Pages for 11g and 10g OAM Agents

OAM WebGate Element	Description
Virtual Host	<p>Check the box beside Virtual Host if you installed a WebGate on a Web server that contains multiple Web site and domain names. The WebGate must reside in a location that enables it to protect all of the Web sites on that server.</p> <p>See Also: "About Virtual Web Hosting".</p>
Auto Create Policies	<p>During agent registration, you can have authentication and authorization policies created automatically. This option is checked (enabled) by default.</p> <p>Default: Enabled</p> <p>Shared Registration and Policies: Multiple WebGates (or Access Clients) installed on different Web servers can share a single registration and policies to protect the same resources. This is useful in a high-availability failover environment. To do this:</p> <ol style="list-style-type: none"> 1. WebGate1: Register the first WebGate and enable Auto Create Policies to generate a host identifier (named as you like) and policies. 2. WebGate2: Register the second WebGate, specify the same host identifier as the first WebGate, and disable Auto Create Policies. <p>After registering the second agent, both WebGates use the same host identifier and policies.</p>
IP Validation	<p>Check the box beside IP Validation to ensure a client's IP address is the same as the IP address stored in the ObSSOCookie generated for single sign-on. In the IP Validation Exceptions box, enter any IP addresses to exclude from validation using standard notation for the addresses: for example, 10.20.30.123.</p> <p>When enabled, the IP address stored in the ObSSOCookie must match the client's IP address. Otherwise, the cookie is rejected and the user must re-authenticate.</p> <p>Default: Disabled</p> <p>See Also: "IP Address Validation for WebGates".</p>

Table 15-1 (Cont.) Elements on Create Pages for 11g and 10g OAM Agents

OAM WebGate Element	Description
Agent Key Password	<p>Requested for only Cert mode communication, this passphrase is used to encrypt the private key used for SSL communication between WebGate and the OAM Server in Simple and Cert modes.</p> <p>Note: The Agent Key Password has no relationship to the Access Client Password described earlier within this table.</p> <p>Cert Mode: In this mode, the agent key can be different on the client and server; it is no longer global. Administrators must enter the Agent Key Password to enable generation of a password.xml file during agent registration, which must be copied to the agent side. For certificate generation, you must encrypt the private key (used for SSL) using this password through <code>openssl</code> or other third-party tools to be placed inside <code>aaa_key.pem</code>. At runtime, WebGate retrieves the key from <code>password.xml</code>, and uses it to decrypt the key in <code>aaa_key.pem</code>.</p> <ul style="list-style-type: none"> • If the key is encrypted, WebGate internally invokes the call back function to obtain the password. • If the key is encrypted and <code>password.xml</code> does not exist, WebGate cannot establish connections with the OAM Server. • If the key is not encrypted, there is no attempt to read <code>password.xml</code>. <p>For more information, see Securing Communication.</p>
Resource Lists	
Protected Resource (URI) List	<p>URIs for the protected application: <code>/myapp/login</code>, for example. Each URI for the protected application should be specified in a new row of the table for the Protected Resource List.</p> <p>Default: <code>/**</code></p> <p>The default matches any sequence of characters within zero or more intermediate levels spanning multiple directories.</p> <p>Add Resources: Each URI should be specified in a new row of the table for the Protected Resource List. Click the + button to add a resource to the Protected Resource List. For instance, if you add <code>/financial</code> (and repeat to add <code>/myfinancial</code>) the following URLs are seeded into the designated policies of the Application Domain when Auto Create Policies is selected):</p> <pre> /financial yields Resource URL /financial/** /myfinancial yields Resource URL /myfinancial/** /** </pre> <p>See Also: "Resource URL, Prefixes, and Patterns".</p>

Table 15-1 (Cont.) Elements on Create Pages for 11g and 10g OAM Agents

OAM WebGate Element	Description
Public Resource (URI) List	<p>Each public application should be specified in a new row of the table for the Public Resource List.</p> <p>Add Resources: Each URI should be specified in a new row of the table for the Public Resource List. Click the + button to add a resource to the Public Resource List. For instance, if you add <code>/people</code> the following URLs are included here and in the Application Domain (when Auto Create Policies is selected):</p> <p style="padding-left: 40px;"><code>/people</code></p> <p>See Also: "Resource URL, Prefixes, and Patterns".</p>
See Also:	Table 15-3

To help streamline WebGate registration, some elements are concealed during the create operation and default values are applied.

Note:

All changes made using the Oracle Access Management Console are taken up without restarting the application server. Changes are reflected automatically after the reconfiguration timeout period.

15.2.2 User-Defined WebGate Parameters

Certain supported parameters can be defined by Administrators entering values directly on the WebGate registration page or within the OAM Agent remote registration request template.

[Table 15-2](#) describes supported user-defined parameters. Each parameter can have only one value.

Table 15-2 User-Defined WebGate Parameters

User-Defined WebGate Parameter	Description
ChallengeRedirectMethod	<p>Configure this user-defined authentication POST data preservation parameter for both the embedded credential collector (ECC) and the detached credential collector (DCC).</p> <p>Value: GET POST DYNAMIC</p> <p>Note: Preference is given first to the Authentication Scheme containing this parameter; second to the WebGate providing this user defined parameter. Otherwise, default behavior is Dynamic.</p> <p>See Also: Table 22-23</p>

Table 15-2 (Cont.) User-Defined WebGate Parameters

User-Defined WebGate Parameter	Description
ChallengeRedirectMaxMessageBytes	<p>Configure this user-defined WebGate parameter to limit the size of the message data received as obrareq.cgi and obrar.cgi. Message data is comprised of query string length, if present (or POST data length, if POST data is present). If message size exceeds this limit, the message is not processed and the existing message is shown in the browser. The event is logged as usual.</p> <p>Default: 8192 bytes</p> <p>Notes:</p> <p>obrareq.cgi is the authentication request in the form of a query string redirected from WebGate to OAM Server.</p> <p>obrar.cgi is the authentication response string redirected from the OAM Server to WebGate.</p> <p>See Also: "Configuring Authentication POST Data Handling" Table 15-2</p>
MaxPostDataBytes	<p>Authentication post-data preservation parameter for both the embedded credential collector (ECC) and the detached credential collector (DCC).</p> <p>This parameter requires a positive integer value that restricts the maximum number of bytes of POST data that is submitted as user credentials and sent to the OAM Server.</p> <p>Default: 8192 bytes</p> <p>Assigning MaxPostDataBytes to a Resource WebGate gives preference to restricting the size of the post data received from the application before forwarding the post data to be preserved.</p> <p>See Also: "Configuring the PasswordPolicyValidationScheme" "Configuring Authentication POST Data Handling" Table 22-23</p>
MaxPreservedPostDataBytes	<p>Configure this user-defined WebGate parameter (or user-defined Authentication Scheme challenge parameter) for authentication POST-data preservation.</p> <p>Default: 8192 bytes</p> <p>Note: Preference is given first to the Authentication Scheme containing this parameter; second to the WebGate providing this user-defined parameter. Otherwise, default behavior is 8192 bytes.</p> <p>This parameter defines the maximum length of POST data that WebGate can preserve. If the size of inbound raw user POST data (or encrypted post data after processing), crosses this limit, POST data is dropped and the existing authentication flow continues. The event is logged as usual.</p> <p>See Also: "Configuring Authentication POST Data Handling" Table 22-23</p>
PostDataRestoration	<p>Authentication post-data preservation parameter for both the embedded credential collector (ECC) and the detached credential collector (DCC). This parameter requires a value of <code>true</code> or <code>false</code>.</p> <p>Default: <code>false</code></p> <p>When set to <code>true</code>, WebGate initiates POST data preservation.</p> <p>See Also: "Configuring Authentication POST Data Handling"</p>

Table 15-2 (Cont.) User-Defined WebGate Parameters

User-Defined WebGate Parameter	Description
serverRequestCacheType ECC Only	<p>Authentication post-data preservation parameter by the embedded credential collector (ECC).</p> <p>This OAM Server parameter in oam-config.xml indicates mechanism to be used to remember the request context. Possible values are FORM, COOKIE, or CACHE.</p> <p>Default: COOKIE</p> <p>FORM is the required value for POST data preservation.</p> <p>See Also: TempStateMode in Table 22-23. "Configuring Authentication POST Data Handling"</p>
UrlInUTF8Format=true	<p>In an environment that uses Oracle HTTP Server 2, this parameter must be set to true to display latin-1 and other character sets.</p>
ProxySSLHeaderVar=IS_SSL	<p>Uses when the WebGate is located behind a reverse proxy, SSL is configured between the client and the reverse proxy, and non-SSL is configured between the reverse proxy and the Web server. It ensures that URLs are stored as HTTPS rather than HTTP. The proxy ensures that URLs are stored in HTTPS format by setting a custom header variable indicating whether it is servicing an SSL or non-SSL client connection.</p> <p>The value of the ProxySSLHeaderVar parameter defines the name of the header variable the proxy must set. The value of the header variable must be "ssl" or "nonssl".</p> <p>If the header variable is not set, the SSL state is decided by the SSL state of the current Web server.</p> <p>Default: IS_SSL</p>
client_request_retry_attempts=1	<p>WebGate-to-OAM Server timeout threshold specifies how long (in seconds) the WebGate waits for the OAM Server before it considers it unreachable and attempts the request on a new connection.</p> <p>If the OAM Server takes longer to service a request than the value of the timeout threshold, the WebGate abandons the request and retries the request on a new connection.</p> <p>Default: 1</p> <p>Note: The new connection that is returned from the connection pool can be to the same OAM Server, depending on your connection pool settings. Also, other OAM Servers may also require more time to process the request than the time specified on the timeout threshold. In some cases, the WebGate can retry the request until the OAM Servers are shut down. You can configure a limit on the number of retries that the WebGate performs for a non-responsive server using the client_request_retry_attempts parameter.</p>
InactiveReconfigPeriod=10	<p>The WebGate update thread reads the shared secret from the OAM Server every 1 minute when WebGate is active. The OAM Server server returns the shared secret in its own cache (the OAM Server cache).</p> <p>Default: 10 (minutes)</p> <p>See Also: <i>Tuning Performance</i></p>

Table 15-2 (Cont.) User-Defined WebGate Parameters

User-Defined WebGate Parameter	Description
fallbackToContainerPolicy=true	<p>Used for the IAMSuiteAgent. When set to <code>false</code>, user access to the resource is denied and an HTTP response code, 403 is returned.</p> <p>When set to 'true' the request goes through to the container and uses whatever policy (related to J2EE authentication/authorization) is configured on the container to grant or deny the user access.</p> <p>Default: <code>true</code></p>
logoutRedirectUrl=	Default = <code>http://OAMServer_host:14200/oam/server/logout</code>
protectWebXmlSecuredPagesOnly=true	<p>Used for the IAMSuiteAgent. After the user is authenticated, this parameter is used for all subsequent requests to determine if the Agent should validate the incoming request. When set to:</p> <p><code>false</code>: The Agent always validates the incoming request</p> <p><code>true</code>: The default. The Agent determines whether to validate the incoming request based on the following:</p> <ul style="list-style-type: none"> • If the application specifies 'CLIENT-CERT' as part of the construct: "<code><auth-method></code>" in its web.xml, the Agent validates the incoming request. • If the application does not specify 'CLIENT-CERT' as part of the construct: "<code><auth-method></code>" in its web.xml, the Agent does not validate the incoming request. Instead, the Agent lets the request go through to the application.
maxAuthorizationResultCacheElements	<p>Max Authorization Results Cache Elements—Number of elements maintained in the Authorization Result Cache. This cache maintains information about authorization results for associated sessions. For example:</p> <pre>maxAuthorizationResultCacheElems=10000</pre> <p>Default = 100000</p> <p>See Also: <i>Tuning Performance</i></p>
authorizationResultCacheTimeout	<p>Authorization Results Cache Timeout—Number of elements maintained in the Authorization Result Cache. This cache maintains information about authorization results for associated sessions. For example:</p> <pre>authorizationResultCacheTimeout=60</pre> <p>Default, if no time is specified = 15 (seconds)</p> <p>Note: Authorization Results Cache Timeout is not set by default.</p> <p>With the cache enabled, the first request result persists for the cache duration. This magnifies the effect causing a brief time delay. For example suppose you set an authentication policy Response and set a custom session attribute <code>exmpl:sample</code>. The corresponding authorization policy Response returns this as <code>HEADER SESSION_ATTR_EXMPL=sample</code>. When a user access the URL protected by these policies, the header comes after a few refreshes. Initially, however, the value might not be found.</p> <p>A value of 0 disables the cache. With no cache, it takes two requests for the header response to be filled. The first sets the session variable used, the second uses the session variable. Oracle recommends that you do not set a Response value in the same authorization request that triggers it.</p> <p>See Also: <i>Tuning Performance</i>.</p>

Table 15-2 (Cont.) User-Defined WebGate Parameters

User-Defined WebGate Parameter	Description
UniqueCookieNames	<p>Controls WebGate cookie name format:</p> <ul style="list-style-type: none"> Legacy format (still the default and backward compatible): <prefix>_<host>:<port>_<suffix> Enabled UniqueCookieNames format (rfc2109-compliant cookie name restriction): <prefix>_<host>:<port>_<suffix> Disabled: Cookie name format is <prefix>_<suffix>. No <host>:<port> and No <host>_<port> is added to the cookie name. Any other value is treated as the default legacy format: <prefix>_<host>:<port>_<suffix>
<i>11g WebGate only</i>	
SetKeepAlive	<p>By default, SetKeepAlive is ON. In this case, a first keep-alive message will be sent after the default idle time of 2 minutes. To change this behavior, set a new value for the parameter. If SetKeepAlive=Off, the feature is disabled and no keep-alive messages will be sent. If SetKeepAlive=x (where x is some positive integer value), the keep-alive message will be sent after the channel is idle for x minutes. Any firewall or load balancer should be configured to forward the TCP/IP keep-alive messages to the actual end parties (front-ending Access Manager server).</p> <p>A programmatic way to change the idle time is implemented for Linux64, Linux32, and Windows32 WebGates. This is not possible on SPARC Solaris platforms; in that case, SetKeepAlive is enabled and the idle time out for Keep alive must be set manually by the system administrator.</p>
filterOAMAuthnCookie	<p>For 11g WebGate, a user-defined parameter (<code>filterOAMAuthnCookie</code> (default <code>true</code>)) can be used to prevent the OAMAuthnCookie from being passed to downstream applications for security consideration. If you do want to pass the cookie on, then set the <code>filterOAMAuthnCookie</code> parameter to <code>false</code>.</p>
ssoCookie	<p>Controls the OAMAuthnCookie cookie.</p> <p>Default: <code>ssoCookie=httponly</code> <code>ssoCookie=Secure</code></p> <p>Disable either setting: <code>ssoCookie=disablehttponly</code> <code>ssoCookie=disableSecure</code></p> <p>Note: These parameters are configured differently depending on your credential collector configuration.</p> <ul style="list-style-type: none"> For detached credential collector-enabled 11g WebGates, set these parameters directly in the agent registration page. For non-DCC agents (Resource WebGates), these parameters are configured through user-defined challenge parameters in authentication schemes. <p>See Also: Table 22-23 "Configuring Challenge Parameters for Encrypted Cookies" "Configuring 11g WebGate and Authentication Policy for DCC"</p>

Table 15-2 (Cont.) User-Defined WebGate Parameters

User-Defined WebGate Parameter	Description
miscCookies	<p>Controls other miscellaneous Access Manager internal cookies. By default, httponly is enabled for all other (miscellaneous) cookies.</p> <p>Default: miscCookies=httponly miscCookies=Secure</p> <p>Disable either setting: miscCookies=disablehttponly miscCookies=disableSecure</p> <p>Note: These parameters are configured differently depending on your credential collector configuration.</p> <ul style="list-style-type: none"> For detached credential collector-enabled WebGates, set these parameters directly in the agent registration page. For non-DCC agents (Resource WebGates), these parameters are configured through challenge parameters of the same name. <p>See Also: Table 22-23 "Configuring Challenge Parameters for Encrypted Cookies" "Configuring 11g WebGate and Authentication Policy for DCC"</p>
obSSOCookieCoExConfig	<p>Controls the cookie properties set on ObSSOCookie during OAM 10g Co-Existence.</p> <p>Default: obSSOCookieCoExConfig=httponly obSSOCookieCoExConfig=Secure</p> <p>Disable either setting: obSSOCookieCoExConfig=disablehttponly obSSOCookieCoExConfig=disableSecure</p> <p>Disable both settings: obSSOCookieCoExConfig=disableSecure;disablehttponly</p> <p>For detached credential collector-enabled 11g WebGates used for Co-Existence (as DCC or with DCC Tunneling), set this parameter in the agent registration page. See the Co-existence chapter in <i>Oracle Fusion Middleware Migration Guide for Oracle Identity and Access Management</i> for more information.</p>
OAMAuthAuthenticationService Location <i>11g WebGate non-browser client functionality</i>	<p>Activates non-browser client functionality and defines the location of the authentication service.</p> <p><i>OAMAuthUserAgentPrefix=prefix string that acts as the prefix for the "user-agent" HTTP header value.</i></p> <p>For example, to activate this functionality for Identity Connect:</p> <p>OAMAuthAuthenticationServiceLocation=https://login.example.com/nbc</p> <p>Non-browser client functionality is deactivated if the parameter is omitted (or is provided with no value).</p> <p>See Also: Managing Oracle Access Management Mobile and Social .</p>

Table 15-2 (Cont.) User-Defined WebGate Parameters

User-Defined WebGate Parameter	Description
OAMAuthUserAgentPrefix <i>11g WebGate non-browser client functionality</i>	<p>Activates non-browser client functionality and defines the string that acts as a prefix for the "user-agent" http header value.</p> <p>OAMAuthAuthenticationServiceLocation=<i>full URL location of the NBC authentication service.</i></p> <p>For example, to activate this functionality for Identity Connect:</p> <p>OAMAuthUserAgentPrefix=NBC</p> <p>Non-browser client functionality is deactivated if this parameter is omitted (or is provided with no value).</p> <p>See Also: Managing Oracle Access Management Mobile and Social .</p>
RequestContextCookieExpTime	<p>Controls the time (in seconds) to expire OAMRequestContext cookie. Configuring the cookie lifetime is an optional control for deployments with a critical need to handle situations where the cookies could proliferate.</p> <p>Default: not set</p> <p>In the Resource WebGate registration, add this parameter to expire the OAMRequestContext cookie in the configured number of seconds using the "Max-Age" directive on all but IE browsers (default 5 minutes).</p> <p>Note: For Internet Explorer only, this parameter requires a time sync between the browser and Web server hosts because IE uses the "Expires" directive to expire the cookie with an absolute time. However, on IE browsers, when this parameter is not set, OAMRequestContext cookie is a transient session cookie. On other (non-IE) browsers, the cookie is persistent and expires based on the time set using the "Max-Age" directive.</p> <p>See Also: OAMRequestContext in Table 21-6</p>
ProxyTrustedIPList	Multi-valued parameter that holds the list of IP addresses of the trusted proxies or load balancers. See ProxyTrustedIPList .
ProxyRemoteIPHeaderVar	Specifies the name of the HTTP header that contains the list of IP addresses. See ProxyRemoteIPHeaderVar .

15.2.3 IP Address Validation for WebGates

IP address validation is a function that determines if a client's IP address is the same as the IP address stored in the cookie generated for single sign-on. The `IPValidation` parameter turns IP address validation on and off; it is a WebGate specific parameter found in the WebGate profile.

If `IPValidation` is `true`, the IP address stored in the cookie must match the client's IP address, otherwise, the SSO cookie ([Table 1-2](#)) is rejected and the user must reauthenticate. By default, `IPValidation` is `false`. The following is true in regards to enabling and disabling IP Validation.

- Enabling IP Validation on the WebGate automatically enables it on the OAM server side; this can be verified in the Access Manager settings.
- Disabling IP Validation on the WebGate will not disable it on the OAM server.

- IP Validation on the OAM server side should be disabled manually, if and only if it is disabled on all the WebGates.
- When IP Validation is enabled on the WebGate side, server side IP Validation should never be turned off.

Note:

Access Manager now supports Internet Protocol version 6 (IPv6) as well as IPv4.

To configure single sign-on between WebGate and an Access Client that does not have the client IP address at authentication, the IP validation option can be explicitly turned off (set IP Validation to false). When the IP Validation parameter is set to false, the browser or client IP address is not used as a part of the SSO cookie. However, Oracle recommends that you keep IP validation on whenever possible. For WebGate profile configuration information, see [Viewing or Editing an OAM Agent Registration Page in the Console](#). Additional details are in the following sections.

- [IP Validation Exceptions List](#)
- [IP Validation in Load Balanced Environments](#)

15.2.3.1 IP Validation Exceptions List

The IP Validation parameter can cause problems with certain Web application deployments.

For example, Web applications managed by a proxy server typically change the user's IP address, substituting the IP address of the proxy. This prevents single sign-on from using the cookie. The IP Validation Exceptions parameter lists IP addresses that are exceptions to this process. When `IPValidation` is `true`, the IP address is compared to the IP Validation Exceptions List. If the address is found on the list, it does not need to match the IP address stored in the cookie.

You can add as many IP addresses as needed to the Exceptions list - the actual IP addresses of the client and not the IP addresses stored in the `ObSSOCookie` SSO cookie. If an SSO cookie is from one of the exception IP addresses, the Access System ignores the address stored in the SSO cookie for validation. (The IP addresses in the IP Validation Exceptions List can be used when the IP address in the cookie is for a reverse proxy.)

15.2.3.2 IP Validation in Load Balanced Environments

In the case of (proxy servers or) a load balancer, Oracle Access Manager cannot enforce true IP validation because an attacker can use the IP address defined in the exception list. Web applications managed thusly typically change the user's IP address (substituting the IP address of the proxy or load balancer). This can prevent single sign-on using the SSO cookie.

A load balancer adds an "X-forwarded-for" header variable to incoming HTTP requests, containing a comma-space-separated list of the original IP number of the requester. Consider the following example in which the request passed proxy1, proxy2 and proxy3 (proxy3 appears as the remote address of the request). The last IP address is always the IP address that connects to the last proxy.

```
X-Forwarded-For: client1, proxy1, proxy2
```

The trust list will be referenced to look up each IP address from the header, starting with the right-most value. The left-most IP address being the farthest downstream client and each successive proxy that passed the request (adding the IP address from which it received the request).

Within the specified order, the first IP address that does not match any of those in the trusted list is treated as an apparent client IP (defined as the IP address of the initiator of the connection to the furthest node along the communication path that can be trusted). Additionally:

- When all IP addresses from the header (starting from the right side) match with entries in the trusted list, WebGate chooses the end client IP (the left most IP address in the header).
- When the IP address is determined, WebGate obtains a session token that contains the apparent client IP address and IP validation is evaluated by comparing the IP address against the address in the session token.
- When the IP validation feature is enabled within a load balanced deployment, authentication (session creation) and authorization is done by the WebGate with this feature; otherwise the authenticated user must re-authenticate. When WebGate searches for the particular HTTP header, the search is case-insensitive. For example, "X-Forwarded-For" and "X-FORWARDED-FOR" are treated the same.

15.2.3.2.1 ProxyTrustedIPList

`ProxyTrustedIPList` is a user defined, multi-valued WebGate parameter that holds the list of IP addresses for the trusted proxies or load balancers.

The values are space separated. The IP addresses in the IP Validation Exceptions List can be used when the IP address in the cookie is for a reverse proxy.

Figure 15-2 Load Balanced Deployment



In [Figure 15-2](#), the end user's HTTP request passes through REVERSEPROXY1 and REVERSEPROXY2 to reach the actual Web server. In this case, the IP addresses of REVERSEPROXY1 and REVERSEPROXY2 should be added in the `ProxyTrustedIPList` list as follows:

```
ProxyTrustedIPList=10.77.199.59 10.77.199.26
```

Note:

In a centralized authentication deployment, if any Resource WebGate (RWG) or Authentication WebGate (AWG) is behind a proxy, the IP addresses of all intermediaries must be configured (in the `ProxyTrustedIPList` parameter) in the profile of the WebGate behind the proxy. Otherwise, IP validation failures can occur.

15.2.3.2.2 ProxyRemoteIPHeaderVar

The `ProxyRemoteIPHeaderVar` parameter specifies the name of the HTTP header that contains the list of IP addresses.

If this parameter is not provided, the default header X-Forwarded-For is used. This parameter can be configured like any other user-defined parameter in a WebGate profile. For example, in the deployment described in [ProxyTrustedIPList](#), "X-FORWARDED-FOR" and other headers that come to the Web server take the following form.

```
HTTP_X_FORWARDED_FOR="10.77.199.129, 10.77.199.59"  
REMOTE_ADDR="10.77.199.26"
```

15.3 Registering an OAM Agent Using the Console

The registration procedure for WebGate or programmatic Access Client is the same. You can register an OAM-type agent before you deploy it.

Users with valid Administrator credentials can perform the following task to register a WebGate using the Oracle Access Management Console.

See Also:

- [OAM Agent Registration Parameters in the Console](#)
 - *Oracle Fusion Middleware Installation Guide for Oracle Identity and Access Management* chapter "Installing and Configuring Oracle HTTP Server 11g WebGate for OAM"
-
-

After agent registration, you can change the communication mode of the OAM Server if needed. Communication between the agent and server continues to work as long as the WebGate mode is at least at the same level as the OAM Server mode or higher. See [Securing Communication](#).

Note:

You use the same procedure to register a programmatic Access Client. The version is the same as the SDK used to create the Access Client.

See Also:

Oracle Fusion Middleware Upgrade Guide for Oracle Identity and Access Management for details about Identity Connect

Before you begin, confirm that at least one OAM Server is running in the same mode as the agent to be registered.

1. In the Oracle Access Management Console, click **Application Security** at the top of the window.
2. In the Application Security console, select **Create WebGate** from the **Agents** menu.
3. On the **Create WebGate** page, enter required details (those with an *) to register this Agent.

Note:

If you are creating an OAM 10g Agent, also see [Registering and Managing 10g WebGates with Access Manager 11g](#).

4. **Protected Resource List:** In this table, enter individual resource URLs to be protected by this Agent, as shown in [Table 15-1](#).
5. **Public Resource List:** In this table, enter individual resource URLs to be public (not protected), as shown in [Table 15-1](#).
6. **Auto Create Policies:** Check to create a fresh Application Domain and policies (or clear and use the same host identifier as another WebGate and share policies ([Table 15-1](#))).
7. Click **Apply** to submit the registration.
You may also close the page without applying changes, if applicable.
8. Click the **Download** button to download the generated artifacts.
Downloaded artifacts are located in the `$DOMAIN_HOME/output/$Agent_name` folder.
9. **10g WebGate:** See [Registering and Managing 10g WebGates with Access Manager 11g](#) and:
 - a. Proceed as needed for your environment ([Registering and Managing 10g WebGates with Access Manager 11g](#)):
Existing WebGate: Perform Step 8, then go to [Configuring Centralized Logout for Sessions Involving 11g WebGates](#).
New WebGate: Go to "[Locating and Installing the Latest 10g WebGate for Access Manager 11g](#)".
10. Copy the artifacts as follows (or install WebGate with the same specifications, then copy artifacts), including any Simple or Cert mode files. For example, Open mode files include:

Agent & Artifacts	Artifacts
11g WebGate/ Access Client	From the AdminServer (Console) host: <code>\$DOMAIN_HOME/output/\$Agent_Name/</code>
ObAccessClient.xml and cwallet.sso	To the Agent host: <code>\$11gWG_install_dir/WebGate/config</code>
10g WebGate/ Access Client	From the AdminServer (Console) host: <code>\$DOMAIN_HOME/output/\$Agent_Name/</code>
ObAccessClient.xml	To the Agent host: <code>\$10gWG_install_dir/oblix/lib/</code>
Note: Go to Registering and Managing 10g WebGates with Access Manager 11g before completing this task.	

11. **Verify Registration:** These are similar to steps in "[Validating Agent Registration using the Oracle Access Management Console](#)".
 - a. Under Agents in Application Security, search and confirm the Agent name is listed.
 - b. Confirm the Agent's page contains the appropriate information.
 - c. **Auto Create Policies:** Confirm the Application Domain was generated, the host identifier was created for the application, and that resources were created in the Application Domain and associated with the host identifier.
 - d. Perform further tests, as described in "[Verifying Authentication and Access After Remote Registration](#)".
12. Proceed as needed for your deployment:
 - [Configuring and Managing Registered OAM Agents Using the Console](#)
 - [Managing Access Manager SSO, Policies, and Testing](#)

15.4 Bulk Updates to WebGates

Multiple WebGate profiles can be updated simultaneously by grouping common parameters of WebGates into a WebGate template.

Topics

- [Updating Multiple WebGate Profiles](#)
- [WLST Commands for Bulk Updates to WebGate Profiles](#)

15.4.1 Updating Multiple WebGate Profiles

Use WebGate template to group WebGates sharing common parameters and values. You can update the WebGate template using WLST commands. The command updates the parameters across all WebGates associated with the specified WebGate template.

To update multiple WebGates at the same time:

1. Create a WebGate template and map all WebGates with common parameters to that template. See [Creating a WebGate Template and Mapping WebGates to that Template](#) for more information.
2. Run the `updateWebgateTemplateParams` command with the required parameters. For example, to update `ipValidation exceptions` across multiple WebGates, specify the parameter and its corresponding values in the command:

```
updateWebgateTemplateParams(webgateTemplateName="TemplateA",
webgateParamsList="ipValidation,ipValidation exceptions",
webgateValuesList="1,192.168.1.3:1.2.4.6:255.255.255.1:234.12.12.13",
batchSize="20")
```

This command updates the `ipValidation exception` parameter with the IP addresses provided in the command across all WebGates that are associated with `TemplateA`.

The `updateWebgateTemplateParams` command does not remove existing parameters and values. To remove any of the parameters, use the [removeWebgateTemplateParams](#) command.

15.4.1.1 Creating a WebGate Template and Mapping WebGates to that Template

Use the `createWebgateTemplate` and `updateWebgateTemplateToWebgateMapping` WLST commands to create a WebGate template and map WebGates to that template.

1. Create a WebGate template by running the [createWebgateTemplate](#) WLST command.

```
createWebgateTemplate(webgateTemplateName="TemplateA",webgateParamsList="cookieSessionTime,maxConnections",webgateValuesList="24,5")
```

2. Associate WebGates to this template using the [updateWebgateTemplateToWebgateMapping](#) command.

```
updateWebgateTemplateToWebgateMapping( webgateTemplateName="TemplateA",webgateIdsList="IAMSuiteAgent", isWebgateIdsListAFilePath = "False")
```

To use a file containing a list of WebGate Ids, set the `isWebgateIdsListAFilePath` to `true` and specify the file path in the `isWebgateIdsListAFilePath` argument.

```
updateWebgateTemplateToWebgateMapping( webgateTemplateName="TemplateA",webgateIdsList="/tmp/test.txt", isWebgateIdsListAFilePath="True", batchSize="20")
```

15.4.2 WLST Commands for Bulk Updates to WebGate Profiles

The following WebLogic Scripting Tool (WLST) commands support bulk updates to WebGate profiles. More information in the following sections.

- [createWebgateTemplate](#)
- [updateWebgateTemplateToWebgateMapping](#)
- [updateWebgateTemplateParams](#)
- [showWebgateTemplate](#)
- [removeWebgateTemplateParams](#)
- [rollbackWebgatesToPreviousState](#)

15.4.2.1 createWebgateTemplate

The `createWebgateTemplate` command enables you to create a WebGate template with the parameters and values specified within the command.

Description

The `createWebgateTemplate` command creates a WebGate template with the specified parameters and values.

Syntax

```
createWebgateTemplate(webgateTemplateName="<NameOfTemplate>",webgateParamsList="<webgateParamsList>", webgateValuesList="<webgateValuesList>")
```

Arguments	Definition
webgateTemplateName	Specifies the name of the WebGate template to be created.
webgateParamsList	A comma-separated list of WebGate parameters that needs to be added to the WebGate template.
webgateValuesList	Specifies the values corresponding to the webgateParamsList.

Example 15-1 Example

This example illustrates the use of the `createWebgateTemplate` command.

```
createWebgateTemplate(webgateTemplateName="TemplateA",
webgateParamsList="cookieSessionTime, maxConnections", webgateValuesList="24,5")
```

15.4.2.2 updateWebgateTemplateToWebgateMapping

The `updateWebgateTemplateToWebgateMapping` command enables you to associate WebGates with a WebGate template.

Description

The `updateWebgateTemplateToWebgateMapping` command enables you to associate all the WebGates having common parameters with a WebGate template, using WebGate IDs. This command overrides the existing parameters and values.

Syntax

```
updateWebgateTemplateToWebgateMapping(webgateTemplateName="<NameOfTemplate>",
webgateIdsList="<webgateIdsList>", webgateIdsExclusionList="<Webgate1,
Webgate2, ...>", [isWebgateIdsListAFilePath="False"], [batchSize="<batchSize>"])
```

Argument	Definition
webgateTemplateName	Specifies the name of the WebGate template.
webgateIdsList	A comma-separated list of WebGate IDs that needs to be associated with the WebGate template. Supports a file containing a list (separated by new-line) of WebGate IDs.
webgateIdsExclusionList	Specifies the IDs of the WebGates that need to be excluded from the WebGate template.
isWebgateIdsListAFilePath	[Optional] Defaults to <code>False</code> . Set this value to <code>True</code> to specify a file containing the WebGate IDs.
batchSize	[Optional] Specifies the number of WebGate instances to be processed per thread. Default value is 10.

Example 15-2 Example

These examples illustrates the use of `updateWebgateTemplateToWebgateMapping` command.

```
updateWebgateTemplateToWebgateMapping(webgateTemplateName="TemplateA",
webgateIdsList="/tmp/test.txt", webgateIdsExclusionList="Webgate1,Webgate2",
isWebgateIdsListAFilePath = "True", batchSize="20")
```

```
updateWebgateTemplateToWebgateMapping(webgateTemplateName="TemplateA",
webgateIdsList="IAMSuiteAgent", isWebgateIdsListAFilePath = "False")
```

15.4.2.3 updateWebgateTemplateParams

The `updateWebgateTemplateParams` command enables you to update an existing WebGate template with the common parameters and values specified within the command.

Description

The `updateWebgateTemplateParams` command updates the WebGate template with the specified parameters and values that are common across the WebGates of the specified template type. You can use this command to update the WebGate template with additional parameters. This command does not remove the existing parameters. You must use the `removeWebgateTemplateParams` command to remove the parameters from the template.

Syntax

```
updateWebgateTemplateParams (webgateTemplateName="<NameOfTemplate>",
webgateParamsList="<webgateParamsList>", webgateValuesList="<webgateValuesList>",
[batchSize="<batchSize>"])
```

Argument	Definition
<code>webgateTemplateName</code>	[Mandatory] Specifies the name of the WebGate template that needs to be updated. If the template does not exist, a new WebGate template is created with the specified name.
<code>webgateParamsList</code>	List of WebGate parameters associated with the WebGate template. Specify the parameters in the format: <code>webgateParamsList="Parameter1, Parameter2, ..."</code> . Specify the user defined parameters in the format: <code>userdefinedparameters/[parameters]</code> .
<code>webgateValuesList</code>	Specifies the values corresponding to the parameters in the <code>webgateValuesList</code> . Specify the values for the parameters in the format: <code>webgateValuesList="ParameterValue1, ParamaterValue2, ..."</code> Specify the IP for <code>IPValidationExceptions</code> in the following format, for example: 192.168.1.1:255.255.255.1. Use a colon (:) to separate the IP values.

Argument	Definition
batchSize	[Optional] Specifies the number of WebGate instances to be processed per thread of the ThreadPool. Default value is 10. Specify the size in the following format, for example batchSize="20"

Example 15-3 Example

This example illustrates the use of `updateWebgateTemplateParams` command.

```
updateWebgateTemplateParams(webgateTemplateName="TemplateA",
webgateParamsList="idleSessionTimeout", webgateValuesList="3650", batchSize="20")
```

15.4.2.4 removeWebgateTemplateParams

The `removeWebgateTemplateParams` command removes the specified parameters from the WebGate template.

Description

The `removeWebgateTemplateParams` command removes the specified parameters from the WebGate template.

Syntax

```
removeWebgateTemplateParams(webgateTemplateName="<NameOfTemplate>",
webgateParamsList="<webgateParamsList>")
```

Arguments	Definition
webgateTemplateName	Specifies the name of the WebGate template.
webgateParamsList	A comma-separated list of WebGate parameters that needs to be removed from the WebGate template.

Example 15-4 Example

This example illustrates the use of the `removeWebgateTemplateParams` command.

```
removeWebgateTemplateParams(webgateTemplateName="webgateTemplateName1",webgateParamsList="idleSessionTimeout")
```

15.4.2.5 rollbackWebgatesToPreviousState

The `rollbackWebgatesToPreviousState` command returns the WebGate profiles to its previous successful state.

Description

If an update to the WebGate template fails, you can revert all the WebGate information to its previous values (successful state before running the command) using the `rollbackWebgatesToPreviousState` command.

Syntax

```
rollbackWebgatesToPreviousState()
```

There are no arguments for this command

Example 15-5 Example

This example illustrates the use of the `rollbackWebgatesToPreviousState` command.

```
rollbackWebgatesToPreviousState()
```

15.4.2.6 showWebgateTemplate

The `showWebgateTemplate` command displays the metadata of the specified WebGate template.

Description

The `showWebgateTemplate` command can be used to view the current property and values of an existing Webgate Template. This command also lists the WebGates associated with that template.

Syntax

```
showWebgateTemplate(webgateTemplateName="<NameOfTemplate>")
```

Arguments	Definition
<code>webgateTemplateName</code>	[Mandatory] Specifies the name of the WebGate template. The command displays the properties and values for this template.

Example 15-6 Example

This example illustrates the use of the `showWebgateTemplate` command.

```
showWebgateTemplate(webgateTemplateName="DemoTemplate")
```

15.5 Configuring and Managing Registered OAM Agents Using the Console

This section provides the following topics to help you manage registered WebGates:

- [Registered OAM Agent Configuration Parameters in the Console](#)
- [WebGate Search Controls](#)
- [Viewing or Editing an OAM Agent Registration Page in the Console](#)
- [Deleting OAM Agent Registration Using the Console](#)

15.5.1 Registered OAM Agent Configuration Parameters in the Console

Whether you registered the agent using the Oracle Access Management Console or the remote registration utility, you can view the full agent configuration page in the console

[Figure 15-3](#) shows the 11g WebGate Page with the default values.

Figure 15-3 Expanded 11g WebGate Page with Defaults

Access Manager >
accessgate-oic Webgate Apply Download

Version 11g
 Name accessgate-oic
 Description
 Access Client Password *****

* Security Open
 Simple
 Cert

* State Enable
 Disable

* Max Cache Elements 100000
 * Cache Timeout (Seconds) 1800
 * Token Validity Period (Seconds) 3600
 * Max Connections 1
 * Max Session Time 60
 * Failover Threshold 1
 * AAA Timeout Threshold 5

* Preferred Host IAMSuiteAgent

Logout URL
 Logout Callback URL /oam_logout_success

Logout Redirect URL http://slc01mqd.us.orc
 Logout Target URL
 Deny On Not Protected

User Defined Parameters
 proxySSLHeaderVar=S_SSL
 URLInUTF8Format=true
 client_request_retry_attempts=1

* Sleep for (Seconds) 60
 Cache Pragma Header no-cache
 Cache Control Header no-cache

Debug
 IP Validation
 Allow Management Operations
 Allow Token Scope Operations
 Allow Master Token Retrieval
 Allow Credential Collector Operations

Server Lists

Primary Server List + Add X Delete

Access Server	Host Name	Host Port	Max Connections
oam_serve	slc01mqd.u...	5575	1

Secondary Server List + Add X Delete

Access Server	Host Name	Host Port	Max Connections
---------------	-----------	-----------	-----------------

There are only a few differences between 11g and 10g WebGate registration pages.

Note:

Most elements on the agent's page are the same as those you define when using the remote registration tool with the expanded OAM template. ObAccessClient.xml is populated with values after agent registration or modification, regardless of the method you use.

Table 15-3 describes elements on an expanded registration. Additional settings revealed here are used by the OAM Proxy.

Table 15-3 Elements on Expanded 11g and 10g WebGate/Access Client Registration Pages

Element	Description
Name	See: Table 15-1 .
Version	
Description	See Also: " User-Defined WebGate Parameters "
Access Client Password	See Also: " IP Address Validation for WebGates ".
Security	
User-defined Parameters	
IP Validation	
Primary Cookie Domain 10g WebGate only, Registering and Managing 10g WebGates with Access Manager 11g	<p>This parameter describes the Web server domain on which the Agent is deployed, for instance, <i>example.com</i>.</p> <p>You must configure the cookie domain to enable single sign-on among Web servers. Specifically, the Web servers for which you configure single sign-on must have the same Primary Cookie Domain value. WebGate uses this parameter to create the ObSSOCookie authentication cookie.</p> <p>This parameter defines which Web servers participate within the cookie domain and have the ability to receive and update the ObSSOCookie. This cookie domain is not used to populate the ObSSOCookie; rather it defines which domain the ObSSOCookie is valid for, and which Web servers have the ability to accept and change the ObSSOCookie contents.</p> <p>Default: If the client side domain can be determined during registration, the Primary Cookie Domain is populated with that value. However, if no domain is found, there is no value and WebGate uses the host-based cookie.</p> <p>Note: The more general the domain name, the more inclusive your single sign-on implementation will be. For example, if you specify <i>b.com</i> as your primary cookie domain, users will be able to perform single sign-on for resources on <i>b.com</i> and on <i>a.b.com</i>. However, if you specify <i>a.b.com</i> as your primary cookie domain, users will have to re-authenticate when they request resources on <i>b.com</i>.</p>
State <i>Only in the console.</i>	<p>Specifies whether this registration is enabled or disabled.</p> <p>Default = Enabled</p>
Max Cache Elements	<p>Number of elements maintained in the cache. Caches are the following:</p> <ul style="list-style-type: none"> Resource to Authentication Scheme—This cache maintains information about Resources (URLs), including whether it is protected and, if so, the authentication scheme used for protection. (11g WebGate only) Resource to Authorization Policy—This cache maintains information about Resources and associated authorization policy—This cache stores authentication scheme information for a specific authentication scheme ID. <p>The value of this setting refers to the maximum consolidated count for elements in these caches.</p> <p>Default = 100000</p>
Cache Timeout (seconds)	<p>Amount of time cached information remains in the WebGate caches (Resource to Authentication Scheme, Authentication Schemes, and 11g WebGate only Resource to Authorization Policy) when the information is neither used nor referenced.</p> <p>Default = 1800 (seconds)</p>

Table 15-3 (Cont.) Elements on Expanded 11g and 10g WebGate/Access Client Registration Pages

Element	Description
Token Validity Period (seconds) <i>11g WebGate only</i>	<p>Maximum valid time period for an agent token (the content of OAMAuthnCookie for 11g WebGate). This value is the validity period for the obsso cookie. Within this period, only authorization nap calls will pass to the OAM server. Once this period has passed, the obsso cookie will be considered invalid and an 'obrareq.cgi' redirect will occur. The OAM Server will validate the OAM_ID cookie and re-issue a new obsso cookie, or challenge the user if the server side session is expired/deleted/timed out).</p> <p>Default = 3600 (seconds)</p> <p>Note: For 10g WebGates, use Cookie Session Time to set the Token Validity Period.</p>
Max Connections	<p>The maximum number of connections that this WebGate can establish with the OAM Server. This number must be the same as (or greater than) the number of connections that are actually associated with this agent.</p> <p>Default = 1</p>
Max Session Time (hours)	<p>Maximum time to keep network connections from this WebGate to the OAM Server alive. After elapsed time, all the WebGate to OAM Server network connections will be shutdown and replaced with new ones. The unit is based on the maxSessionTimeUnits user-defined parameter which can be 'minutes' or 'hours'. When maxSessionTimeUnits is not defined, the unit is defaulted to 'hours'.</p>
Failover Threshold	<p>Number representing the point when this WebGate opens connections to a Secondary OAM Server.</p> <p>Default = 1</p> <p>For example, if you type 30 in this field and the number of connections to primary OAM Server falls to 29, this Agent opens connections to secondary OAM Server.</p>

Table 15-3 (Cont.) Elements on Expanded 11g and 10g WebGate/Access Client Registration Pages

Element	Description
AAA Timeout Threshold	<p>Number (in seconds) to wait for a response from the OAM Server. If this parameter is set, it is used as an application TCP/IP timeout instead of the default TCP/IP timeout.</p> <p>Default = -1 (default network TCP/IP timeout is used)</p> <p>If using a simple mode WebGate, you can improve the response time of the OAM login page by changing the <code>aaaTimeoutThreshold</code> time parameter in the WebGate profile from -1 to 10.</p> <p>A typical value for this parameter is between 30 and 60 seconds. If set to a very low value, the socket connection can be closed before a reply from OAM Server is received, resulting in an error.</p> <p>For example, suppose a WebGate is configured to talk to one primary OAM Server and one secondary OAM Server. If the network wire is pulled from the primary OAM Server, the WebGate waits for the TCP/IP timeout to learn that there is no connection to the primary OAM Server. The WebGate tries to reestablish the connections to available servers starting with the primary OAM Server. Again, the Agent waits for the TCP/IP timeout to determine if a connection can be established. If it cannot, the next server in the list is tried. If a connection can be established to another OAM Server (either a primary or secondary), the requests are re-routed. However this can take longer than desired.</p> <p>When finding new connections, WebGate checks the list of available servers in the order specified in its configuration. If there is only one primary OAM Server and one secondary OAM Server specified, and the connection to the primary OAM Server times out, the Agent still tries the primary OAM Server first. As a result, the Agent cannot send requests to an OAM Server for a period greater than twice the setting in the OAM Server Timeout Threshold.</p> <p>If the OAM Server takes longer to service a request than the value of the timeout threshold, the Agent abandons the request and retries the request on a new connection. Note that the new connection that is returned from the connection pool can be to the same OAM Server, depending on your connection pool settings. Also, other OAM Server may also take longer to process the request than the time specified on the threshold. In these cases, the Agent can continue to retry the request until the OAM Server is shut down.</p>
ServerConnectionReadTimeout	<p>This parameter can be configured in the ASDK Agent User Defined Parameters section, for further timeout fine-tuning. This setting can be configured for TCP read timeout if required. The read timeout is the timeout on waiting to read data. Specifically, if the server fails to send a byte <i>n</i> seconds after the last byte, a read timeout error will be raised.</p>
poolTimeOut	<p>This parameter can be configured in the ASDK Agent User Defined Parameters section. <code>poolTimeout</code> is the maximum time a request thread will wait to get a connection from the connection pool, before throwing an exception. The default is 30 seconds.</p>

Table 15-3 (Cont.) Elements on Expanded 11g and 10g WebGate/Access Client Registration Pages

Element	Description
Idle Session Timeout <i>10g WebGate only, Registering and Managing 10g WebGates with Access Manager 11g</i>	Default: 3600 Release 7.0.4 WebGates enforced their own idle session timeout only. 10.1.4.0.1 WebGates enforced the most restrictive timeout value among all WebGates the token had visited. With 10g (10.1.4.3), the 7.0.4 behavior was reinstated as the default with this element. To set Idle Session Timeout logic: <ul style="list-style-type: none"> • The default value of <code>leastComponentIdleTimeout</code> instructs the WebGate to use the most restrictive timeout value for idle session timeout enforcement. • A value of <code>currentComponentIdleTimeout</code> instructs the WebGates to use the current WebGate timeout value for idle session timeout enforcement. The idle session timeout behavior varies across WebGate versions. For example, with WebGate 10.1.4.3 it is used to control idle timeout. If both Idle Session Timeout and Cookie Session Time are set, the obsso cookie will be considered invalid when one of the events happens (idle session timeout/cookie session time). In this case, the request will go to the OAM server which will use server side parameter validation to decide if the session has timed out/expired followed by a credential challenge or obsso cookie reissue.
Preferred Host	Specifies how the hostname appears in all HTTP requests as users attempt to access the protected Web server. The hostname within the HTTP request is translated into the value entered into this field regardless of the way it was defined in a user's HTTP request. The Preferred Host function prevents security holes that can be inadvertently created if a host's identifier is not included in the Host Identifiers list. However, it cannot be used with virtual Web hosting. For virtual hosting, you must use the Host Identifiers feature. Defaults to Name (of WebGate registration)
User Defined Parameters	See Also: " User-Defined WebGate Parameters " and <i>Tuning Performance</i> .
Logout URL <i>10g and 11g WebGates</i>	The Logout URL triggers the logout handler, which removes the cookie (ObssoCookie for 10g WebGates; OAMAuthnCookie for 11g WebGates) and requires the user to re-authenticate the next time he accesses a resource protected by Access Manager. Default = [] (not set) Note: This is the standard 10g WebGate configuration parameter used to trigger initial logout through a customized local logout page as described in " Configuring Centralized Logout for 10g WebGate with 11g OAM Servers ".
<i>Additional Logout for 11g WebGate Only</i>	For 11g WebGate single sign-off behavior, specific logout elements and values automate the redirect to a central Logout URL, callback URL, and end_URL. See Also: Table 27-2

Table 15-3 (Cont.) Elements on Expanded 11g and 10g WebGate/Access Client Registration Pages

Element	Description
Logout Callback URL <i>11g WebGate only</i>	<p>The URL to <code>oam_logout_success</code>, which clears cookies during the call back. This can be a URI format without <code>host:port</code> (recommended), where the OAM Server calls back on the <code>host:port</code> of the original resource request. For example:</p> <p>Default = <code>/oam_logout_success</code></p> <p>This can also be a full URL format with a <code>host:port</code>, where OAM Server calls back directly without reconstructing callback URL.</p> <p>Note: In the remote registration template this parameter is named <code>logoutCallbackUrl</code> (Table 15-10).</p> <p>See Also: Table 27-2</p>
Logout Redirect URL <i>11g WebGate only</i>	<p>This parameter is automatically populated after agent registration completes. By default, this is based on the OAM Server host name with a default port of 14200. For example:</p> <p>Default = <code>http://OAMServer_host:14200/oam/server/logout</code></p> <p>See Also: Table 27-2</p>
Logout Target URL <i>11g WebGate only</i>	<p>The value is the name for the query parameter that the OPSS applications passes to WebGate during logout; the query parameter specifies the target URL of the landing page after logout completes.</p> <p>Default: <code>end_url</code></p> <p>Note: The <code>end_url</code> value is configured using <code>param.logout.targeturl</code> in <code>jps-config.xml</code>.</p> <p>See Also: Table 27-2</p>
Sleep for (seconds)	<p>The frequency (in seconds) with which the OAM Server checks its connections to the directory server. For example, if you set a value of 60 seconds, the OAM Server checks its connections every 60 seconds from the time it comes up.</p> <p>Default: 60 (seconds)</p>
Cache Pragma Header Cache Control Header <i>WebGate only (not Access Clients)</i>	<p>These settings apply only to WebGates and control the browser's cache. By default, both parameters are set to <code>no-cache</code>. This prevents WebGate from caching data at the Web server application and the user's browser. However, this may prevent certain operations such as downloading PDF files or saving report files when the site is protected by a WebGate. You can set the Access Manager SDK caches that the WebGate uses to different levels. See http://www.w3.org/Protocols/rfc2616/rfc2616-sec14.html section 14.9 for details.</p> <p>All of the cache-response-directives are allowed. For example, you may need to set both cache values to <code>public</code> to allow PDF files to be downloaded.</p> <p>Defaults: <code>no-cache</code></p> <p>Note: Browsers may store a local cached copy of content served by an OAM protected resource. Some browsers, including Internet Explorer, cache content accessed via HTTPS which may be retrieved by other users who have access to the same computer at a future time. Please ensure that the Cache Directives are set based on the sensitivity of the application content.</p> <p>See Also: <i>Tuning Performance</i></p>

Table 15-3 (Cont.) Elements on Expanded 11g and 10g WebGate/Access Client Registration Pages

Element	Description
Debug	Debugging can be enabled or not.
Deny on Not Protected <i>WebGates only (not Access Clients)</i>	<p>Oracle recommends enabling Deny On Not Protected.</p> <p>When enabled, this element denies access to all resources to which access is not explicitly allowed by a rule or policy. Enabling this can limit the number of times the WebGate queries the OAM Server, and can improve performance for large or busy Application Domains.</p> <ul style="list-style-type: none"> • 11g WebGate: Always enabled, and cannot be changed • 10g WebGate: Can be disabled. <p>Important: Deny on Not Protected overrides Host Identifiers and Preferred Host. Oracle recommends enabling Deny on Not Protected. Otherwise security holes can occur in large installations with multiple Host Identifiers, virtual hosts, and other complex configurations.</p>
Allow Management Operations	<p>This Agent Privilege function enables the provisioning of session operations per agent, as follows:</p> <ul style="list-style-type: none"> • Terminate session • Enumerate sessions • Add or Update attributes for an existing session • List all attributes for a given session ID or read session <p>Default: Disabled</p> <p>Note: Only privileged agents can invoke session management operations. When this parameter is enabled, session management requests (listed above) are processed by the OAM Server. If disabled, such requests are rejected for the agent.</p>
<i>11g WebGate only</i>	
Allow Credential Collector Operations <i>11.1.2.0.0 and later WebGate only</i>	<p>Activates WebGate detached credential collector functionality for simple-form or dynamic multi-factor authentication.</p> <p>Default: Disabled</p> <p>See Also: "Configuring 11g WebGate and Authentication Policy for DCC"</p>
Allow Master Token Retrieval	Allows the ASDK code to retrieve the OAM_ID cookie.
Allow Token Scope Operations	Allows the ASDK code to scope the OAM_ID cookie to the domain level instead of host level.
Sharepoint Impersonation User <i>10g WebGate only, Registering and Managing 10g WebGates with Access Manager 11g</i>	<p>The trusted user for impersonation, in Active Directory. This user should not be used for anything other than impersonation. The constraints are the same as any other user in Active Directory.</p> <p>Note: SharePoint impersonation is separate and distinct from the Access Manager user impersonation feature described in the <i>Oracle Fusion Middleware Developer's Guide for Oracle Access Management</i>.</p>
Sharepoint Impersonation Password <i>10g WebGate only, Registering and Managing 10g WebGates with Access Manager 11g</i>	<p>This is the trusted user password for impersonation. The constraints are the same as any other user password in Active Directory.</p> <p>Oracle recommends that the user choose a very complex password, because the trusted user is granted powerful permissions. Also, check the box <code>Password Never Expires</code>. The impersonation module should be the only entity that ever sees the trusted user account. It is extremely difficult for an outside agency to discover that the password has expired.</p>

Table 15-3 (Cont.) Elements on Expanded 11g and 10g WebGate/Access Client Registration Pages

Element	Description
Primary Server List	Identifies Primary Server details for this Agent. The default is based on the OAM Server: <ul style="list-style-type: none"> • Server Name • Host Name • Host Port • Max Number (maximum connections this WebGate will establish with the OAM Server (not the maximum total connections the WebGate can establish with all OAM Servers).)
Secondary Server List	Identifies Secondary OAM Server details for this agent, which must be specified manually: <ul style="list-style-type: none"> • Server Name • Host Name • Host Port • Max Number (maximum connections this WebGate will establish with the OAM Server (not the maximum total connections the WebGate can establish with all OAM Servers).)

15.5.2 WebGate Search Controls

You can create a new WebGate registration, or search for a specific WebGate or group of WebGates (all 11g WebGates, for instance).

Figure 15-4 shows the WebGates Search controls, defaults, and the empty Search Results table.

Figure 15-4 WebGate Search Controls and Create Button

The screenshot shows a web interface for managing WebGates. At the top, there are tabs for 'Webgates', 'OSSO Agents', and 'OpenSSO Agents'. Below the tabs is a search bar with the text 'Search for an existing WebGate or click the Create WebGate button to create a new one.' and a '+ Create WebGate' button. The search controls include a 'Search' section with a 'Name' input field, a 'State' dropdown menu set to 'Enabled', a 'Version' dropdown menu set to 'All', and input fields for 'Preferred Host', 'Primary Server', and 'Secondary Server'. There are 'Search' and 'Reset' buttons. Below the search controls is a 'Search Results' section with a toolbar containing 'Actions', 'View', '+ Create', 'Duplicate', 'Edit', 'Delete', 'Monitor', and 'Detach'. The results table has columns for 'Row', 'Name', 'Version', 'Preferred Host', 'State', 'Primary Server', and 'Secondary Server'. The table contains two rows of data. At the bottom, it shows 'Rows Selected 1'.

Row	Name	Version	Preferred Host	State	Primary Server	Secondary Server
1	accessgate-olc	11g	IAMSuiteAgent	Enabled	slc01mqd.us.oracle.com:5575	
2	IAMSuiteAgent	10g	IAMSuiteAgent	Enabled	slc01mqd.us.oracle.com:5575	

If you do not know the exact name, you can use a wild card (*) in the search string. From the search results table, you can choose an name to open and view or edit the registration page.

The controls available on this page are described in Table 15-4. Most of the controls apply to all three (WebGates, OSSO Agents and OpenSSO Agents) tabs; controls specific to each tab are marked accordingly.

Table 15-4 Agent Search Controls

Control	Description
Create WebGate	Click to open a fresh WebGate registration page.
Create OSSO Agent	Click to open a fresh OSSO Agent registration page.
Create OpenSSO Agent	Click to open a fresh OpenSSO Agent registration page.
Name	Enter the name (or partial name and wild card (*)) as defined on the registration page. For example: entering a* could return <i>Agent_WebGate_AccessDebugNew</i> in the result table.
Version (<i>Webgates tab only</i>)	Choose a WebGate version to narrow the search and results: <ul style="list-style-type: none"> • 11g • 10g
Preferred Host (<i>Webgates tab only</i>)	Enter all (or part of with a wild card (*)) hostname as it appears in HTTP requests. For example: iam* could return IAMSuiteAgent in the result stable.
State (<i>Webgates tab only</i>)	Choose a state to narrow the search and results: <ul style="list-style-type: none"> • Enabled • Disabled
Primary Server (<i>Webgates tab only</i>)	Enter the entire (or partial with a wild card (*)) Primary Server name.
Secondary Server (<i>Webgates tab only</i>)	Enter the entire (or partial with a wild card (*)) Secondary Server name.
Agent ID (<i>OSSO Agents tab only</i>)	Enter the entire (or partial with a wild card (*)) Agent ID value.
Agent Type (<i>OpenSSO Agents tab only</i>)	Select the target Agent type: <ul style="list-style-type: none"> • J2EE • Web

15.5.2.1 Searching for an OAM Agent Registration

Before you begin, the Agent must be a registered agent of Access Manager.

1. In the Oracle Access Management Console, click Application Security at the top of the window.
2. In the Application Security console, click **Agents**.
3. If not already displayed, select the desired agent type tab.
4. **Find:**
 - **All Enabled:** Select **Version All**, **State All**, and click the **Search** button.
 - **An Agent ID (OSSO Agents tab only):** enter the desired Agent ID into the **Agent ID** field.
 - **An Agent Type (OpenSSO Agents tab only):** from the **Agent Type** drop-down list, select **J2EE** or **Web**, as appropriate for your search.

- **A WebGate Version:** From the **Version** list, choose **10g** or **11g** and click the **Search** button.
 - **An Agent/WebGate Name:** In the text field, enter the exact name of the instance you want to find and click the **Search** button. For example:
my_OAM_WebGate
5. Click the **Search Results** tab to display the results table, then:
 - **Edit or View:** Click the **Edit** command button in the tool bar to see the configuration page.
 - **Delete:** Proceed to "[Deleting OAM Agent Registration Using the Console](#)".
 - **Detach:** Click **Detach** in the tool bar to expand the table to a full page.
 - **Reconfigure Table:** Select a **View** menu item to alter the appearance of the results table.
 6. Apply any changes (or dismiss the page) when you finish.

15.5.3 Viewing or Editing an OAM Agent Registration Page in the Console

Users with valid Administrator credentials can change any setting for registered WebGates and programmatic Access Clients using the Oracle Access Management Console. The procedure is the same whether you are editing a WebGate or Access Client registration.

For example, you might want to revise the time-out threshold or other settings used by the OAM Proxy.

After changes, updated details are propagated through a runtime configuration update process. There is usually no need to copy the artifacts over to the WebGate configuration area. (Artifacts need only be copied to the WebGate directory path if the agent name, access client password, or security mode is changed.)

Note:

All changes made using the Oracle Access Management Console are taken up without restarting the application server, and are reflected automatically after the reconfiguration time-out period.

Before you begin, the agent must be registered and available in the Oracle Access Management Console.

See Also:

- [Creating OAM WebGate Page and Parameters](#)
-
-

1. From the Oracle Access Management Console, click **SSO Agents**.
 - a. Double-click **OAM Agents** node to display the **Search** page.
 - b. **Find the Registration:** See "[WebGate Search Controls](#)".

- c. Click the Agent name in the results table to open the page.
2. Modify Agent details, and Primary or Secondary Server details, as needed (Table 15-1, Table 15-3).
3. **User-Defined Parameters:** Add or modify these as desired (Table 15-2).
4. Click **Apply** to submit changes and dismiss the Confirmation window (or close the page without applying changes).
5. Copy the artifacts as follows (or install WebGate with the same specifications, then copy artifacts), including any Simple or Cert mode files. For example, Open mode files include:

Agent & Artifacts	Artifacts
11g WebGate/ Access Client ObAccessClient.xml and cwallet.sso	From the AdminServer (Console) host: \$DOMAIN_HOME/output/\$Agent_Name/ To the Agent host: \$11gWG_install_dir/WebGate/config.
10g WebGate/ Access Client ObAccessClient.xml Note: Go to Registering and Managing 10g WebGates with Access Manager 11g before completing this task.	From the AdminServer (Console) host: \$DOMAIN_HOME/output/\$Agent_Name/ To the Agent host \$10gWG_install_dir/oblix/lib/ObAccessClient.xml

6. Proceed as needed for your deployment:
[Managing Access Manager SSO, Policies, and Testing.](#)

15.5.4 Deleting OAM Agent Registration Using the Console

Users with valid Administrator credentials can delete a registered WebGate or Access Client from the Oracle Access Management Console. Deleting an agent registration removes only the registration and not the associated host identifier, Application Domain, resources, or the agent itself.

See Also:

[OAM Agent Registration Parameters in the Console](#)

Before you begin, evaluate the Application Domain, resources, and policies associated with this agent and ensure that these are configured to use another agent (or be removed).

1. In the Oracle Access Management Console, click **Application Security** at the top of the window.
 - a. In the Application Security console, click **Agents** to display the Search page.
 - b. **Find the Registration:** See "[WebGate Search Controls](#)".

- c. Select the desired registration from the results table, and open it to confirm it is the right agent to remove, close the page.
 - d. Select the name in the results table, click the Delete (X) button, check the Confirmation dialog and then close the page.
 - e. Confirm the Agent name is no longer listed in the navigation tree.
2. **Remove the 10g Agent Instance:** Perform the following steps (see "[Removing a 10g WebGate from the Access Manager 11g Deployment](#)", if needed).
- a. Shut down the Web server.
 - b. Remove WebGate software using the utility provided in the following directory path:
 $\$WebGate_install_dir/oui/bin$
 Windows: `setup.exe -d`
 Unix: `runInstaller -d`
 - c. Revert to the httpd.conf version before updates for WebGate. For example:
 Copy: `httpd.conf.ORIG`
 To: `httpd.conf`
 - d. Restart the Web server.
 - e. On the agent host, manually remove the WebGate instance directory:
11g WebGate/Access Client: $\$11gWebGate_instance_dir/WebGate/config$.
10g WebGate/Access Client: $\$WebGate_install_dir/oblix/lib/$

15.6 Remote Registration Tool, Modes, and Process

As an alternative to using the console for agent registration, you can use the remote registration utility, `oamreg`, with Oracle-provided templates.

Administrators using the Oracle Access Management Console or remote registration utility must have credentials stored in the System Store ([Managing Data Sources](#)).

This section provides details about remote registration in the following topics:

- [Remote Registration Command Arguments and Modes](#)
- [Common Elements within Remote Registration Request Templates](#)
- [Key Use, Generation, Provisioning, and Storage](#)

See Also:

["OAM Remote Registration"](#)

15.6.1 Remote Registration Command Arguments and Modes

Before using the remote registration tool, two environment variables within the script must be set: `OAM_REG_HOME` and `JAVA_HOME`.

Table 15-5 describes the samples, which presume the location of the tool to be `$OAM_REG_HOME` on a Linux system. Your environment might be different.

Table 15-5 Environment Variables to Set within oamreg

Environment Variable	Description
OAM_REG_HOME	The directory under which RREG.tar was exploded, followed by /rreg: <code>\$OAM_HOME/oam/server/rreg/client/rreg</code>
JAVA_HOME	The location where Java is located on the client computer. For example: <code>\$WLS_HOME/Middleware/jdk160_11</code> . Note: <code>\$JAVA_HOME</code> should point to JDK 1.6. (JDK 1.7 can also be used in R2PS3.)

Additionally, before using the remote registration tool, you must modify several tags in the request file, as described later (Table 15-9).

The arguments required to run the remote registration script are listed in Table 15-6.

Table 15-6 Remote Registration Command Arguments: mode

Arguments	Description
mode	Either: <ul style="list-style-type: none"> inband outofband
input/ <i>filename.xml</i>	Either the absolute path to the input file (*request.xml or an <i>agentName_Response.xml</i>), or the path relative to the value of <code>\$OAM_REG_HOME</code> . The preferred location is <code>\$OAM_REG_HOME/input</code>

The sample commands illustrated in Table 15-7 presume the location of the tool to be `$OAM_REG_HOME` on a Linux system.

Table 15-7 Remote Registration Command Samples

Command Type	Sample (on Linux)
In-band Administrator In-band Request	<code>./bin/oamreg.sh inband input/*Request.xml</code>
In-band Administrator Submitted Request	<code>./bin/oamreg.sh outofband input/starting_request.xml</code>
Out-of-band Administrator Returned Response	<code>./bin/oamreg.sh outofband input/agentName_Response.xml</code>

Table 15-7 (Cont.) Remote Registration Command Samples

Command Type	Sample (on Linux)
[prompt_flag] value: [-noprmt]	<p>Optional. When -noprmt is used, oamreg does not wait for prompts (password, and so on). Instead these values can be piped in, either from an input file or from the command line itself using an echo command.</p> <p>Examples from \$OAM_REG_HOME location:</p> <pre>(echo username; echo password; echo WebGate_password;) ./bin/oamreg.sh inband input/Request.xml -noprmt config.file</pre> <pre>(echo username; echo password; echo WebGate_password; echo httpsert_trust_prompt;) ./bin/oamreg.sh inband input/Request.xml -noprmt</pre> <pre>(echo username; echo password; echo WebGate_password; echo cert_password;) ./bin/oamreg.sh inband input/ Request.xml -noprmt</pre> <pre>(echo username; echo password; echo WebGate_password; echo httpsert_trust_prompt; echo cert_password;) ./bin/oamreg.sh inband input/Request.xml -noprmt</pre> <p>See Also: "Updating Agents Remotely"</p>

Note:

After launching the script, Administrators are prompted for a username and password (unless -noprmt is used as shown in [Table 15-7](#).)

After running the script, messages inform you of success or failure. Following a successful registration or update, you must copy the artifacts to the Agent host, as outlined in "[Updating Agent Configuration Files](#)".

15.6.2 Common Elements within Remote Registration Request Templates

Regardless of agent type, global elements are common within all remote registration request files.

[Table 15-8](#), shows the global elements.

Note:

In [Table 15-8](#), descriptions of each element are omitted; see [Table 15-1](#).

Table 15-8 Common Elements in Remote Registration Requests

Element	Example
<serverAddress>	<serverAddress>http://{oam_admin_server_host}:{oam_admin_server_port}</serverAddress>
<agentName>	<agentName>RREG_OAM</agentName>
<hostIdentifier>	<hostIdentifier>RREG_HostId11G</hostIdentifier>
<agentBaseUrl>	<agentBaseUrl>http://{web_server_host}:{web_server_port}</agentBaseUrl>
Note: Extended Templates only	
<autoCreatePolicy>	<autoCreatePolicy>>true</autoCreatePolicy>
Note: Extended Templates only	
<applicationDomain>	<applicationDomain>RREG_OAM11G</applicationDomain>
Note: Extended Templates only	
<virtualhost>	<virtualhost>>false</virtualhost>
Note: Extended Templates only	

15.6.3 Key Use, Generation, Provisioning, and Storage

Each registered agent has a symmetric key, regardless of the registration method (Oracle Access Management Console versus remote registration).

Each application will have a symmetric key whether it is protected through mod_osso, or an OAM Agent. This key is generated by the registration tool. Storage of the application mapping, key, and type of Agent persists in the system configuration for retrieval as needed. The following sections contain details.

- [Key Use](#)
- [Key Generation Process](#)
- [Key Accessibility and Provisioning](#)
- [Key Storage](#)

15.6.3.1 Key Use

Each 11g WebGate agent has its own secret key that is shared between the agent and the OAM Server.

If one 11g WebGate is compromised, other 11g WebGates are unaffected. The following presents an overview:

- Encrypt/Decrypt the host-based WebGate-specific OAMAuthnCookie_<host:port>_<random number>.
- Encrypt/Decrypt the data that is redirected between WebGate and OAM Server.

15.6.3.2 Key Generation Process

The key generation occurs automatically when the agent is registered, regardless of the method used (Oracle Access Management Console versus remote registration). There is one symmetric key per agent.

Figure 15-5 illustrates the process of key generation.

Figure 15-5 Key Generation

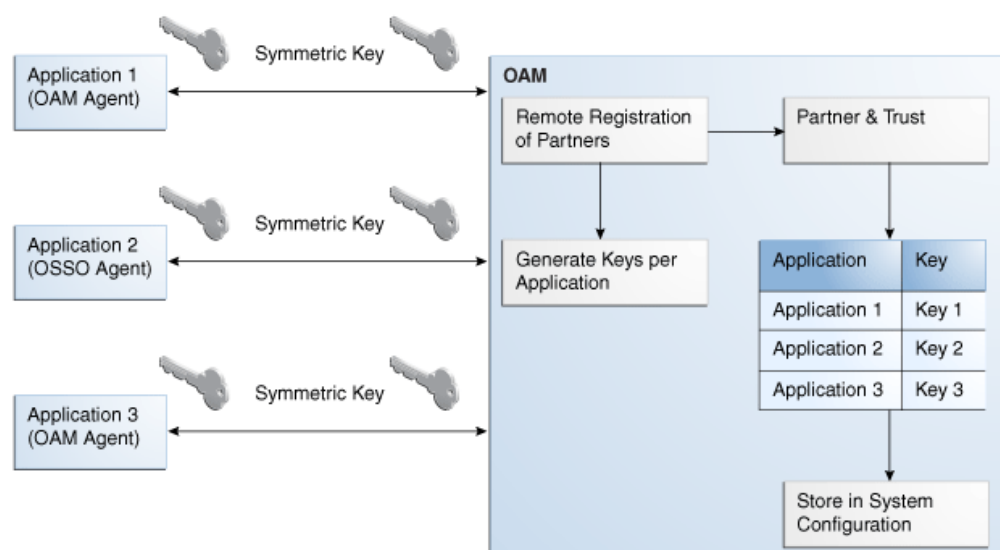

15.6.3.3 Key Accessibility and Provisioning

Each Agent specific key must be accessible to the corresponding WebGate through a secure local storage on the client machine. Cryptographic keys are not stored in the data store. Instead, an alias to an entry in a Java keystore or CSF repository is stored; the Partner and Trust Management API obtain the actual key when it is requested.

The agent specific secret key:

- Is provisioned during remote registration (either in-band mode or out-of-band mode)
- Is unique so that it can uniquely identify each agent.
- Is distributed securely back to the agent (either through the wire during in-band mode or through a separate secure channel during out-of-band mode).
- Is saved in the Oracle Secret Store, in the SSO wallet. SSO wallet creation applies only to 11g WebGates (not to 10g WebGates or other agent types).

Note:

The Oracle Secret Store is a container that consolidates the storage of secret keys and other security-related secret information inside the Oracle Wallet, not in plain-text. The SSO wallet relies on underlying file system security to protect its data. Opening this wallet does not require a password. The SSO wallet depends on the operating system and file permissions for its security.

- Is saved in the Oracle Secret Store, in an auto-login editable SSO wallet, upon completion of registration.

15.6.3.4 Key Storage

The SSO wallet containing the agent key must be located in `cwallet.sso`, in the directory with `ObAccessClient.xml` in `WebGate_instance_dir/WebGate/config` (for example, `$WebTier_MW_Home/Oracle_WT1/instances`).

The SSO wallet does not require a user password, and should be protected with the proper file permission (700) or registry on Windows.

15.7 Remote Registration Templates: OAM Agents

Oracle provides both a short and extended registration request template for use with the remote agent registration tool: `oamreg.sh` (Linux) or `oamreg.bat` (Windows).

This topic focuses on OAM Agent templates (WebGates and Access Clients). Regardless of the template you choose (short or extended), only a few differences exist between 11g and 10g OAM Agent templates, listed in [Table 15-9](#) and stored in `$OAM_REG_HOME/input/`.

Table 15-9 Remote Registration Request Templates for OAM Agents

Template Type	Template Name in <code>\$OAM_REG_HOME/input/</code>
Abbreviated (Short) Form	<ul style="list-style-type: none"> • <code>OAM11GRequest_short.xml</code> (11g WebGates) • <code>OAMRequest_short.xml</code> (10g WebGates)

Table 15-9 (Cont.) Remote Registration Request Templates for OAM Agents

Template Type	Template Name in \$OAM_REG_HOME/input/
Extended (Full) Form	<ul style="list-style-type: none"> OAM11gRequest.xml (11g WebGates) OAMRequest.xml (10g WebGates)
Other Templates	For a look at these specialized tasks and templates, see:
Update Agent	<ul style="list-style-type: none"> "Updating Agents Remotely "
Create Policies, Update Policies	<ul style="list-style-type: none"> "Managing Policies and Application Domains Remotely"
Out-of-band Response	<ul style="list-style-type: none"> "Performing Out-of-Band Remote Registration "

Note:

Despite being nearly identical for both 10g and 11g WebGates, be sure to copy and use the appropriate request for your release.

15.7.1 OAM Agent Parameters for Remote Registration

Element names in request templates might differ slightly from counterparts in the Oracle Access Management Console. Unless explicitly stated, all information applies equally to requests for both 10g and 11g WebGates/Access Clients.

[Table 15-10](#) describes elements specific to OAM Agent remote registration requests. Protected, public, and excluded resource lists are included in both the short and extended request templates for OAM Agents.

Note:

Descriptions of elements in [Table 15-10](#) are in [Table 15-3](#).

Table 15-10 Elements in Extended OAM Agent Remote Registration Requests

Element	Example
<serverAddress>	See Table 15-8 .
<agentName>	
<hostIdentifier>	
<agentBaseUrl>	
<autoCreatePolicy>	
<applicationDomain>	
<virtualhost>	
<allowCredentialCollectorOperations>	
<allowMasterTokenRetrieval>	

Table 15-10 (Cont.) Elements in Extended OAM Agent Remote Registration Requests

Element	Example
<hostPortVariationsList>	<pre><hostPortVariationsList> <host>host1</host> <port>7777</port> </hostPortVariations> <host>host2</host> <port>7778</port> </hostPortVariations> </hostPortVariationsList></pre>
<protectedResourcesList>	<pre><protectedResourcesList> <resource></resource> </protectedResourcesList></pre>
<publicResourcesList>	<pre><publicResourcesList> <resource>/public/index.html </resource> </publicResourcesList></pre>
<excludedresourcesList>	<pre><excludedresourcesList> <resource>/excluded/index.html </resource> </excludedresourcesList></pre>
<primaryCookieDomain> 10g Request Only In OAMRequest.xml (10g WebGates) <hostIdentifier> is also used as preferred HTTP host	<pre><primaryCookieDomain>{client_domain} </primaryCookieDomain></pre>
<maxCacheElems>	<pre><maxCacheElems>100000 </maxCacheElems></pre>
<cacheTimeout>	<pre><cacheTimeout>1800</cacheTimeout></pre>
<tokenValidityPeriod> 11g Request Only	<pre><tokenValidityPeriod>3600 </tokenValidityPeriod></pre>
<cookieSessionTime> 10g WebGate only, Registering and Managing 10g WebGates with Access Manager 11g	<pre><cookieSessionTime>3600 </cookieSessionTime></pre>
<maxConnections>	<pre><maxConnections>1</maxConnections></pre>

Table 15-10 (Cont.) Elements in Extended OAM Agent Remote Registration Requests

Element	Example
<maxSessionTime>	<maxSessionTime>24</maxSessionTime>
<idleSessionTimeout> <i>10g WebGate only, Registering and Managing 10g WebGates with Access Manager 11g</i>	<idleSessionTimeout>3600</idleSessionTimeout>
<failoverThreshold>	<failoverThreshold>1</failoverThreshold>
<aaaTimeoutThreshold>-	<aaaTimeoutThreshold>-1</aaaTimeoutThreshold>
<sleepFor>	<sleepFor>60</sleepFor>
<debug>	<debug>>false</debug>
<security>	<security>open</security>
<denyOnNotProtected>	<denyOnNotProtected>1</denyOnNotProtected>
<allowManagementOperations>	<allowManagementOperations>>false</allowManagementOperations>
<cachePragmaHeader> <cacheControlHeader>	<cachePragmaHeader>no-cache</cachePragmaHeader> <cacheControlHeader>no-cache</cacheControlHeader>
<ipValidation>	<ipValidation>0</ipValidation>
<ipValidationExceptions>	<ipValidationExceptions> <ipAddress>10,11,11,11</ipAddress> <ipAddress>10,11,11,12</ipAddress> <ipAddress>10,11,11,13</ipAddress> </ipValidationExceptions>

Table 15-10 (Cont.) Elements in Extended OAM Agent Remote Registration Requests

Element	Example
<logOutUrls>	<pre><logOutUrls> <url>/logout1.html</url> <url>/logout2.html</url> </logOutUrls></pre>
<logoutCallbackUrl> <i>11g Request Only</i>	<pre><logoutCallbackUrl>/oam_logout_success </logoutCallbackUrl></pre>
<logoutTargetUrlParamName> <i>11g Request Only</i>	<pre><logoutTargetUrlParamName>end_url </logoutTargetUrlParamName></pre>
User-Defined Parameter Names	Examples
	<pre><userDefinedParameters> <userDefinedParam> <name>...</name> <value>...</value> </userDefinedParam></pre>
MaxPostDataLength	<pre><userDefinedParameters> <userDefinedParam> <name>MaxPostDataLength</name> <value>750000</value> </userDefinedParam></pre>
maxSessionTimeUnits	<pre><userDefinedParameters> <name>maxSessionTimeUnits</name> <value>hours</value> </userDefinedParam></pre>
useIISBuiltinAuthentication	<pre><userDefinedParameters> <name>useIISBuiltinAuthentication </name> <value>>false</value> </userDefinedParam></pre>
idleSessionTimeoutLogic 10g WebGates only	<pre><userDefinedParameters> <name>idleSessionTimeoutLogic </name> <value>leastComponentIdleTimeout </value> </userDefinedParam></pre>

Table 15-10 (Cont.) Elements in Extended OAM Agent Remote Registration Requests

Element	Example
URLInUTF8Format	<pre><userDefinedParameters> <name>URLInUTF8Format</name> <value>>true</value> </userDefinedParam></pre>
inactiveReconfigPeriod <i>Shared secret applies to only 10g WebGate</i> <i>Configuration applies to only 11g WebGate.</i>	<pre><userDefinedParameters> <name>inactiveReconfigPeriod</name> <value>10</value> </userDefinedParam></pre>
WaitForFailover	<pre><userDefinedParameters> <name>WaitForFailover</name> <value>-1</value> </userDefinedParam></pre>
proxySSLHeaderVar	<pre><userDefinedParameters> <name>proxySSLHeaderVar</name> <value>IS_SSL</value> </userDefinedParam></pre>
client_request_retry_attempts	<pre><userDefinedParameters> <name>client_request_retry_attempts </name> <value>1</value> </userDefinedParam></pre>
ContentLengthFor401Response	<pre><userDefinedParameters> <name>ContentLengthFor401Response </name> <value>0</value> </userDefinedParam></pre>
SUN61HttpProtocolVersion	<pre><userDefinedParameters> <name>SUN61HttpProtocolVersion </name> <value>1.0</value> </userDefinedParam></pre>
impersonationCredentials	<pre><userDefinedParameters> <name>username:password </name> <value>cred</value> </userDefinedParam></pre>

Table 15-10 (Cont.) Elements in Extended OAM Agent Remote Registration Requests

Element	Example
UseWebGateExtForPassthrough	<pre><userDefinedParameters> <name>UseWebGateExtForPassthrough </name> <value>>false</value> </userDefinedParam></pre>
syncOperationMode	<pre><userDefinedParameters> <name>syncOperationMode</name> <value>>false</value> </userDefinedParam></pre>
filterOAMAuthnCookie <i>11g Request only.</i>	<pre><userDefinedParameters> <name>filterOAMAuthnCookie</name> <value>>true</value> </userDefinedParam></pre>

15.8 Performing Remote Registration for OAM Agents

This section includes the following topics describing how to perform remote registration, which is similar regardless of the agent type:

- [Acquiring and Setting Up the Remote Registration Tool](#)
- [Creating Your Remote Registration Request](#)
- [Performing In-Band Remote Registration](#)
- [Performing Out-of-Band Remote Registration](#)

15.8.1 Acquiring and Setting Up the Remote Registration Tool

The oamreg client tool can be used anywhere, not just on the OAM Server.

If the oamreg home is already exploded, you can use the following procedure to acquire and update the oamreg script for your operating system:

Windows: oamreg.bat

Linux: oamreg.sh

Note:

Oracle Recommends using the latest tool and files by applying the latest bundle patch and untarring RREG.tar.gz again as described here.

For remote registration, two variables are required: JAVA_HOME and OAM_REG_HOME, as described in [Table 15-11](#).

Table 15-11 Variables Required for Remote Registration

Location	Variable	Description
Client Side	JAVA_HOME	The JDK 1.6 location on the computer that relies on \$JAVA_HOME already set in the environment. (JDK 1.7 can also be used in R2PS3.)
	OAM_REG_HOME	The absolute file location for RREG HOME (directory under which RREG.tar was exploded, followed by /rreg and one directory above where the scripts reside). For example: \$OAM_HOME/oam/server/rreg/client/rreg If \$ORACLE_IDM_HOME is \$MW_HOME/ Oracle_IDM: export \$OAM_REG_HOME=\$MW_HOME/ Oracle_IDM/oam/server/rreg
rreg folder location (not RREG.tar.gz location)	JAVA_HOME	Relies on \$JAVA_HOME already set in the environment.
	OAM_REG_HOME	Is already set in the script during the installation.

See Also:

["Remote Registration Command Arguments and Modes"](#)

1. Locate RREG.tar.gz file in the following path:
\$ORACLE_HOME/oam/server/rreg/client/RREG.tar.gz
2. Untar RREG.tar.gz file, which creates directories beneath /client containing the required tool and templates.
3. In the oamreg script (.../rreg/client/rreg/bin) set environment variables as follows:
 - a. Set JAVA_HOME to JDK 1.6 ([Table 15-11](#)).
JDK 1.7 can also be used in R2PS3.
 - b. Set OAM_REG_HOME to the *exploded_dir_for_RREG.tar/rreg* based on your environment (client side or server side [Table 15-11](#)).
4. Proceed with "[Creating Your Remote Registration Request](#)".

15.8.2 Creating Your Remote Registration Request

You can create an appropriate *Request*.xml file to provide input for the specific agent you want to register.

Before you begin, read [Remote Registration Templates: OAM Agents](#)

1. Locate the required *Request*.xml input file for the agent you want to register:

Regardless of the template you choose (short or extended), only a few differences exist between 11g and 10g agent templates stored in \$OAM_REG_HOME/input/. For example:

OAM11GRequest.xml

2. Copy the request file to a new name. For example:

From: OAM11GRequest.xml

To: *my11gagent_request.xml*

3. In the Request file, modify information to reflect details for your agent and the resources to protect using details in:
 - [Table 15-9](#)
 - [Table 15-10](#)
4. Proceed with task needed for your environment:
 - [Performing In-Band Remote Registration](#)
 - [Performing Out-of-Band Remote Registration](#)

15.8.3 Performing In-Band Remote Registration

The OAM Administrator within the network performs all tasks. Regardless of agent type, you can perform in-band remote registration.

For this example, an OAM Agent is being registered using the short request on a Linux system. Your agent type, request template, and output files will be different.

See Also:

Oracle Fusion Middleware Installation Guide for Oracle Identity and Access Management chapter "Installing and Configuring Oracle HTTP Server 11g WebGate for OAM"

Before you begin, read:

- [Acquiring and Setting Up the Remote Registration Tool](#)
 - [Creating Your Remote Registration Request](#)
1. On the computer hosting the Agent, run the registration command and specify your own *Request*.xml as the input file. For example:
 2. Provide the registration Administrator user name and password when asked.

The following example illustrates a sample rreg registration output.

```
Welcome to OAM Remote Registration Tool!  
Parameters passed to the registration tool are:  
Mode: inband
```

```

Filename: /scratch/work/mw1916/idm1385/oam/server/rreg/input/1.xml
Enter admin username:oamadminuser
Username: oamadminuser
Enter admin password:
Do you want to enter a Webgate password?(y/n):
n
Do you want to import an URIs file?(y/n):
n

```

```

-----
Request summary:
OAM Agent Name:RREG_1234
URL String:RREG_1234
Registering in Mode:inband
Your registration request is being sent to the Admin server at: http://
slc01huw.us.example.com:20081
-----

```

Inband registration process completed successfully! Output artifacts are created in the output folder.

The output folder is in the same location where RREG.tar.gz was expanded: /rreg/output/AgentName/

3. Review the native configuration file created for the agent in the /rreg/output/AgentName/ folder.
4. **Finalize Registration:** Perform the following steps to replace the earlier agent configuration file if it is not already replaced:
 - a. Copy artifacts in /rreg/output/AgentName/ to update the agent configuration. For example:

From the AdminServer (Console) host

```
/rreg/output/Agent_Name/ObAccessClient.xml and cwallet.sso
```

To the Agent host: \$11gWG_install_dir/WebGate/config. For example:

```
$WebTier_MW_Home/Oracle_WT1/instances/instance1
/config/OHS/ohs1/WebGate/config
```
 - b. Restart the OAM Server hosting the agent.
5. Proceed with "[Validating Remote Registration and Resource Protection](#)".

15.8.4 Performing Out-of-Band Remote Registration

This section provides steps for Administrators outside (and inside) the network as they work together to register an agent remotely. During out-of-band remote registration, an administrator outside the network submits a registration request to an Administrator within the network. After processing the request, the in-band Administrator returns the following files to the out-of-band Administrator to configure his environment.

Table 15-12 Files Returned by in-band Administrator to out-of-band Administrator

File	Description
<i>agentName_Response.xml</i>	Returned to, and used by, the out-of-band Administrator. Oracle recommends that you do not open or edit <i>agentName_Response.xml</i> .
Native Web server configuration files	Returned to, and used by, the out-of-band Administrator to update his Web server.
See Also	"Updating Agent Configuration Files"

The steps performed by each Administrator are identified:

- **In-Band Administrator:** Identifies a task performed by the Web server Administrator within the network.
- **Out-of-Band Administrator** Identifies a task performed by the Web server Administrator outside the network

See Also:

Oracle Fusion Middleware Installation Guide for Oracle Identity and Access Management chapter "Installing and Configuring Oracle HTTP Server 11g WebGate for OAM"

Steps here illustrate registering an OAM Agent on a Linux system. Your templates and output files will be different.

Before you begin, read [Acquiring and Setting Up the Remote Registration Tool](#)

See Also:

[Registering and Using Agents with Access Manager](#) , if needed.

1. **Out-of-Band Administrator:** Create and send your *starting_request.xml* file to the in-band Administrator for processing (see "[Creating Your Remote Registration Request](#)"):

```
$WLS_Home/Middleware/Oracle_<IDM1>/oam/server/rreg/client/rreg/output/AgentName/starting_request.xml
```

2. **In-Band Administrator:**

- a. Run the registration command and specify the out-of-band Administrator's *starting_request.xml* as the input file. For example:

```
./bin/oamreg.sh outofband input/starting_request.xml
```
- b. Provide the Registration Administrator user name and password when asked.
- c. Read messages on-screen to confirm:

```
Success: "... registration process completed successfully!
```

Response.xml location: "... created in input folder ..."

The input folder is in the same location where RREG.tar.gz was expanded: /rreg/input/

- d. Return the *agentName_Response.xml* file to the out-of-band Administrator along with any other artifacts. For example:

agentName_Response.xml

3. **Out-of-Band Administrator:** Updates the environment, as follows.

- a. On the computer hosting the Agent, run the remote registration command and specify the received *agentName_Response.xml* as the input file. For example:

```
./bin/oamreg.sh outofband input/agentName_Response.xml
```

- b. Copy artifacts generated in /rreg/output/AgentName/ to update the agent configuration (), then restart the OAM Server hosting the agent. For example, ObAccessClient.xml and cwallet.sso:

From the AdminServer (Console) host /rreg/output/Agent_Name/ObAccessClient.xml and cwallet.sso

To the Agent host: \$11gWG_install_dir/WebGate/config. For example:

```
$WebTier_MW_Home/Oracle_WT1/instances/instance1
/config/OHS/ohs1/WebGate/config
```

- c. Proceed with "[Validating Remote Registration and Resource Protection](#)".

15.9 Remote Agent Update Modes and Templates

Administrators quickly update, validate, or delete an existing agent registration using remote management modes.

This section provides the following topics:

- [Remote Agent Update Modes](#)
- [Remote 11g OAM Agent Updates Template](#)

15.9.1 Remote Agent Update Modes

To manage an existing agent registration, remote agent management modes can be used.

[Table 15-13](#) presents remote agent management modes. Command parameters include the mode, input *Request.xml file (a relative path with respect to \$OAM_REG_HOME, the preferred location for the input *Request.xml files):

```
./oamreg.sh <mode> <input_file> [prompt_flag] [component.oam.config_file] <mode>
value
```

Table 15-13 Remote Agent Update Modes and Input Files

Mode and Input Files	Description and Syntax
agentUpdate mode <i>OAM11GUpdateAgentRequest.xml</i> <i>OAMUpdateAgentRequest.xml</i>	Allows Administrators to update existing agent attributes, regardless of agent type: ./bin/oamreg.sh agentUpdate input/ *UpdateAgentRequest.xml See Also: OpenSSOUpdateAgentRequest, Registering and Managing Legacy OpenSSO Agents OSSOUpdateAgentRequest, Registering and Managing Legacy OSSO Agents
agentValidate mode <i>No input file needed.</i>	Validates whether the agent is already provisioned in Oracle Access Manager: ./bin/oamreg.sh agentValidate agentname
agentDelete mode <i>No input file needed.</i>	Allows Administrators to delete the agent registration: ./bin/oamreg.sh agentDelete agentname

15.9.2 Remote 11g OAM Agent Updates Template

You use `OAM11GUpdateAgentRequest.xml` to pass specific Agent-update values to the remote registration tool, `oamreg`.

The primary differences between the update request and the original registration request is that the update request.

Table 15-14 Delta: OAM Agent Update versus Registration Request

Delta	Element
Adds	<ipValidation>
Omits	<ipValidationExceptions>
Omits	<hostidentifier>
Omits	<virtualhost>
Omits	<hostportVariations>
Omits	<authCreatePolicy> and application domain-related elements
Omits	<ssoServerVersion>
Omits	<idleSessionTimeout>

See Also:

- [Table 15-3](#)
-
-

15.10 Updating Agents Remotely

This section provides the following topics for agents registered with Access Manager, regardless of agent type:

- [Updating Agent Registrations Remotely](#)
- [Validating an Agent Registration Remotely](#)
- [Removing an Agent Registration Remotely](#)

15.10.1 Updating Agent Registrations Remotely

Regardless of agent type, you can remotely update agents registered with Access Manager.

This topic provides the steps to update agents registered with Access Manager, regardless of agent type. Before you begin, review [Remote Agent Update Modes](#)

See Also:

- ["Registering and Managing Legacy OpenSSO Agents "](#)
 - ["Registering and Managing Legacy OSSO Agents"](#)
 - ["Managing 10g OAM Agents Remotely"](#)
-
-

1. Set up the registration tool as described in, "[Acquiring and Setting Up the Remote Registration Tool](#)".
2. Create your update request using one of the following templates:
 - OAM11GUpdateAgentRequest.xml
 - OAMUpdateAgentRequest.xml (10g) "[Registering and Managing 10g WebGates with Access Manager 11g](#)"
 - OSSOUpdateAgentRequest.xml "[Registering and Managing Legacy OSSO Agents](#)"
 - OpenSSOUpdateAgentRequest.xml "[Registering and Managing Legacy OpenSSO Agents](#)"
3. On the computer hosting the Agent, run the following command with agentUpdate mode specify your own *Request*.xml as the input file. For example:

```
./bin/oamreg.sh agentUpdate input/*UpdateAgentRequest.xml
```

4. Provide the registration Administrator user name and password when asked.

5. Read the messages on-screen to confirm:
 - **Success:** On-screen message confirms

```
agentUpdate process completed successfully!  
  
Native Configuration File Location: "... created in output  
folder ..."
```

The output folder is in the same location where RREG.tar.gz was expanded: /
rreg/output/AgentName/
6. Finalize Agent Registration: Copy the updated ObAccessClient.xml and cwallet.sso.

From the AdminServer (Console) host: /rreg/output/Agent_Name/
To the Agent host: \$11gWG_install_dir/WebGate/config. For example:

```
$WebTier_MW_Home/Oracle_WT1/instances/instance1/ config/OHS/ohs1/  
WebGate/config
```
7. Restart the OAM Server that is hosting this agent and proceed to "[Validating an Agent Registration Remotely](#)".

15.10.2 Validating an Agent Registration Remotely

Regardless of agent type, you can remotely validate agent registration.

This topic provides the steps to validate agent registration, regardless of agent type. Before you begin, review [Remote Agent Update Modes](#)

1. Set up the registration tool as described in, "[Acquiring and Setting Up the Remote Registration Tool](#)".
2. On the Agent host, run the following command in agentValidate mode. For example:

```
./bin/oamreg.sh agentValidate agentname
```
3. Provide the registration Administrator user name and password when asked.
4. Read the messages on-screen to confirm:
 - **Success:** On-screen message confirms

```
AgentValidation process completed successfully!
```

15.10.3 Removing an Agent Registration Remotely

You can remove a registered agent, regardless of agent type.

Before you begin, review [Remote Agent Update Modes](#)

1. Set up the registration tool as described in, "[Acquiring and Setting Up the Remote Registration Tool](#)".
2. On the computer hosting the Agent, run the following agentDelete command. For example:

```
./bin/oamreg.sh agentDelete agentname
```

3. Provide the registration Administrator user name and password when asked.
4. Read the messages on-screen to confirm:
 - **Success:** On-screen message confirms
`AgentDelete process completed successfully!`

15.11 Validating Remote Registration and Resource Protection

You can validate registration of an agent regardless of the agent type.

You must be an in-band Administrator to perform tasks using the Oracle Access Management Console. Out-of-band Administrators must test authentication and access remotely.

- [Validating Agent Registration using the Oracle Access Management Console](#)
- [Verifying Authentication and Access After Remote Registration](#)

15.11.1 Validating Agent Registration using the Oracle Access Management Console

Only an in-band Administrator can validate agent registration.

See Also:

[Managing Policies to Protect Resources and Enable SSO](#)

1. **Validate Agent Registration** in the Oracle Access Management Console:
 - a. Confirm Agent details under Application Security in the Oracle Access Management Console.
 - b. Confirm the updated Agent configuration files are in the appropriate location, as described in "[Performing Remote Registration for OAM Agents](#)".
2. **Validate Shared Components**, Host identifier: Confirm that the host identifier is defined in the Oracle Access Management Console.
3. **Validate Application Domain**: Under the Policy Configuration tab, confirm there is a new Application Domain named after the registered agent. Resources in the Application Domain should be associated with the host identifier.
4. Proceed with "[Verifying Authentication and Access After Remote Registration](#)".

15.11.2 Verifying Authentication and Access After Remote Registration

After registration, protected resource should be accessible with proper authentication without restarting the AdminServer or OAM Server.

Both in-band and out-of-band Administrators can use the following procedure to validate proper registration and policies.

The procedure here provides several methods for confirming that registration, authentication, and authorization are properly configured and operational. The procedures is nearly identical for all agent types.

1. Enter the URL for an application protected by the registered OAM Agent to confirm that the log in page appears (proving that the authentication redirect URL was specified appropriately). For example:

```
http://exampleWebserverHost.sample.com:8100/resource1.html
```

2. On the Log In page, enter a valid username and password when asked, and click Login.
3. Check the OAM specific cookies are created in the browser session. For example:

ObSSOCookie:

```
Set-Cookie:
ObSSOCookie=GGVEuvjmrMe%2FhbItbjT24CBmJoleCIfDIwQ1atdGdnY4mt6kmdSekSFeAAFvFrZZZ
xDfvpkfs3ZLZFbaZU2rAn0YYUM3JUWVYkYFwB%2BBK7V4x%2FeuYHj%2B8gwOyxhNYFna3iSx1MSZBE
y51KTBfsDY0iw6R%2BCxUh008uZDTYHI3s0c7AQsYrEiQTuUV3nv1omaFZlk1GuZa4J7ycaGbIUyqwX
rM0cKuBJNd6sX1LiRj9HofYQsvUV7ToqeAOpDS7z9qs5LhqU5Vq60bBn12DTX6zNX6Lcc0L5tVvvh7%
2Bn0Akz2%2BoDkLs%2BBTkeGcB3ppgC9;httponly; path=/; domain=.example.com;
```

OAM_ID Cookie:

```
Set-Cookie:
OAM_ID=v1.0~0~E1EBBC9846E09857060A68E79AEEB608~AA79FC43C695162B6CDE3738F40E94DA
6408D58B879AC3B467EBBD4800743C899843672B3511141FFABCF58B2CDCB700C83CC734A913625
7C4ABDA6913C9EF5A4E05C5D03D3514F2FECACD02F1C1B9314D76B4A68CB7A8BE42AEB09AFB98B8
EB; path=/; HttpOnly
```

4. Proceed as follows:
 - **Success:** If you authenticated successfully and were granted access to the resource; the configuration is working properly. Proceed with Steps 5 through 12 for further validations.
 - **Failure:** If you received an error during login or were denied access to the resource, check the following:
 - **Login Error:** Confirm that you provided a valid user id and password.
 - **Unavailable Resource:** Confirm that the resource is available.
 - **Wrong Redirect URL:** Verify the redirect URL in the Oracle Access Management Console.
5. **User Variations:** Perform steps 1 through 4 again with user variations to confirm appropriate behavior (either success for authorized users or failure for unauthorized users).
6. **Request Cancellation:** Perform a partial log in and click Cancel to confirm that the resource is not accessed.
7. **Modified Authentication URL:** Enter a nearly identical authentication URL as you perform Steps 1 through 5 to confirm appropriate response. For example, add a character to the URL string.
8. **Updated Resource:** Perform the following steps to ensure the resource is accessible. For example:

Original Resource: /abc/test.html

Updated Resource: /abc/xyz/test.html

Without restarting the Oracle WebLogic Server:

- Access the updated resource and confirm the user is asked to authenticate and the resource is accessible.
- Access the original resource and confirm that the resource is accessible and the user is not asked for authentication.

9. Various URL Patterns: Verify authentication for various URL patterns as you perform steps 1 through 5.

10. New Authentication Scheme: Perform the following steps to confirm authentication operations without restarting the WebLogic Server.

- Add a new authentication policy that uses a different Authentication Scheme.
- Protect the resource using the new policy.
- Without restarting the Oracle WebLogic Server, perform steps 1 through 4.

See Also:

[Managing Policies to Protect Resources and Enable SSO](#)

11. CGI Resource Header Variable and Cookies: Perform the following steps to confirm authentication operations without having to restart the WebLogic Server.

- Add a new authentication policy to protect a Common Gateway Interface (CGI) resource and set the Response for "Authentication Successful".
- Protect the resource using the new policy.
- Access the CGI resource.
- Check for the header values configured for the response in a CGI data dump.

12. Agent Disabled: Perform the following steps to validate accessibility and authentication if WebGate is disabled in ObAccessClient.xml (WebGate should pick up the enabled value from oam-config.xml).

- Disable the Agent State. Start the Web server and OAM Server. Access an application protected by the Agent and confirm that you are asked to authenticate.

15.12 Replacing the IAMSuiteAgent with an 11g WebGate

Access Manager and Oracle Identity Manager are among the Oracle Fusion Middleware 11g components. During initial configuration with the WebLogic Server Configuration Wizard, the IAMSuiteAgent is registered with Access Manager 11g along with the IDM domain host identifier and an Application Domain named for the agent.

You can skip this section if you are not replacing the IAMSuiteAgent with an 11g WebGate.

Oracle Fusion Middleware uses Access Manager to protect Oracle Identity Management consoles out of the box using the IAMSuiteAgent. To protect applications beyond containers, you can replace the IAMSuiteAgent with a 11g

WebGate (to protect the same set of applications using the same Application Domain and policies as the pre-registered IAMSuiteAgent). The following list is the task overview for this section.

1. [Registering a Replacement 11g WebGate for IAMSuiteAgent](#)
2. [Installing the Replacement 11g WebGate for IAMSuiteAgent](#)
3. [Updating the WebLogic Server Plug-in Configuration](#)
4. Optional: [Confirming the AutoLogin Host Identifier for an OAM / OIG Integration](#)
5. Optional: [Configuring OAM Security Providers for WebLogic](#)
6. Optional: [Disabling IAMSuiteAgent](#)
7. [Configuring Centralized Logout for 11g WebGates](#)
8. [Verifying the Webgate Configuration](#)

15.12.1 Registering a Replacement 11g WebGate for IAMSuiteAgent

You can register a replacement 11g WebGate using the remote registration tool, in-band mode.

For more information about the remote registration tool, processing, and request files, see [Registering and Managing OAM 11g Agents](#)

In this example, `OAMRequest_short.xml` is used as a template to create an agent named `11g4IAM`, protecting `/*`, and declaring a public resource, `/public/index.html`. Your values will be different.

Note:

To use IAM Suite policies with the replacement WebGate, ensure that the WebGate registration is configured to use the IAMSuiteAgent Host Identifier and Preferred Host.

1. Acquire the Access Manager remote registration tool and set up the script for your environment. For example:
 - a. Locate `RREG.tar.gz` file in the following path:

```
$ORACLE_HOME/oam/server/rreg/client/RREG.tar.gz
```
 - b. Untar `RREG.tar.gz` file to any suitable location. For example:

```
exploded_dir_for_RREG.tar/rreg/input/oamreg.
```
 - c. In the `oamreg` script, set the following environment variables based on your situation (client side or server side) and information in [Table 15-5](#):

```
OAM_REG_HOME = exploded_dir_for_RREG.tar/rreg
JAVA_HOME = Java_location_on_the_computer
```
2. Create the registration request and ensure that the `autoCreatePolicy` parameter is set to `false`:

- a. Locate OAMRequest_short.xml and copy it to a new file. For example:

```
exploded_dir_for_RREG.tar/rreg/input/oamreg/
```

Copy: OAM11gRequest_short.xml

To: 11g4IAM.xml

- b. Edit 11g4IAM.xml to include details for your environment. For example, if you are changing from the IAMSuiteAgent to an 11g WebGate Agent your request might look like the following:

```
<OAM11gRegRequest>
  <serverAddress>http://ruby.uk.example.com:7001</serverAddress>
  <hostIdentifier>11g4IAM</hostIdentifier>
  <agentName>11g4IAM</agentName>
  <autoCreatePolicy>false</autoCreatePolicy>
  <logOutUrls><url>oamssso/logout.html</url></logOutUrls>
  ...retain defaults for remaining elements...
  ...
  ...
</OAM11gRegRequest>
```

See Also:

["Creating Your Remote Registration Request"](#)

3. Register the agent. For example:

- a. Locate the remote registration script.

Linux: rreg/bin/oamreg.sh

Windows: rreg\bin\oamreg.bat

- b. From the directory containing the script, execute the script using inband mode. For example:

```
$. /bin/oamreg.sh inband input/11g4IAM.xml
```

```
Welcome to OAM Remote Registration Tool!
Parameters passed to the registration tool are:
Mode: inband
Filename: ...
```

- c. When prompted, enter the following information using values for your environment:

```
Enter your agent username: userame
  Username: userame
Enter agent password: *****
Do you want to enter a WebGate password?(y/n)
n
iv. Do you want to import an URIs file?(y/n)
n
```

- d. Review the final message to confirm that this was a successful registration:

```
Inband registration process completed successfully! Output artifacts are
created in the output folder"
```

4. Log in to the Oracle Access Management Console and review your new registration:
 - a. From the System Configuration tab, Access Manager section, open the OAM Agents node and locate your agent registration.

See Also:

["WebGate Search Controls"](#)

- b. Double-click the agent's name to display the registration page and review the details. For example:

Note:

If you install a fresh WebGate, enter matching details during installation.

- c. **OAM Proxy Port**—From the System Configuration tab, Common Configuration section, double-click Server Instances and locate the port on which the OAM Proxy is running.
5. Copy the artifacts as follows (or install WebGate with the same specifications, then copy artifacts), as described in ["Installing the Replacement 11g WebGate for IAMSuiteAgent"](#).

Agent & Artifacts	Artifacts
11g WebGate/ Access Client	From the AdminServer (Console) host:
ObAccessClient.xml and	<code>\$DOMAIN_HOME/output/\$Agent_Name/</code>
cwallet.sso	To the Agent host: <code>\$11gWG_install_dir/WebGate/config</code>

6. Proceed to ["Updating the WebLogic Server Plug-in Configuration"](#).

15.12.2 Installing the Replacement 11g WebGate for IAMSuiteAgent

After provisioning you must install the 11g WebGate to replace the IAMSuiteAgent.

During the installation, you must provide some of the same information for the WebGate as you did when provisioning it. Following is the task overview.

1. Install the 11g WebGate as described in *Oracle Fusion Middleware Installation Guide for Oracle Identity and Access Management*.
2. Replace IAMSuiteAgent Registration as described in ["Updating the WebLogic Server Plug-in Configuration"](#).

15.12.3 Updating the WebLogic Server Plug-in Configuration

After provisioning and installing the 11g WebGate to replace the IAMSuiteAgent, the `mod_wl_ohs.conf` file requires specific entries to instruct the WebGate Web server to forward requests to the applications on the WebLogic Server.

The generic name of the WebLogic Server plug-in for Apache is `mod_weblogic`. For Oracle HTTP Server 11g, the name of this plug-in is `mod_wl_ohs` (the actual binary name is `mod_wl_ohs.so`). Examples show exact syntax for implementation.

The following example illustrates the areas that must be changed using sample entries. Entries for your environment will be different.

Updates for the 11g Webgate in mod_wl_ohs.conf

```
<IfModule weblogic_module>
  <Location /oamconsole>
    SetHandler weblogic-handler
    WebLogicHost ruby.uk.example.com
    WebLogicPort 6162
  </Location>
  <Location apmmconsole>
    SetHandler weblogic-handler
    WebLogicHost ruby.uk.example.com
    WebLogicPort 6162
  </Location>
  ...
</IfModule>
```

Note:

You need similar Location entries for each of the URIs for all the applications that were earlier accessed directly on the WebLogic Server.

1. Locate the mod_wl_ohs.conf file in the following path:

```
$OHS-INSTANCE_HOME/config/OHS/INSTANCE_NAME/mod_wl_ohs.conf
```

2. Edit the file to include a Location element for each application URI that was previously accessed directly on the WebLogic Server (see the Updates for the 11g Webgate in mod_wl_ohs.conf example).
3. Save the file.
4. Restart the Web server.
5. Proceed to the following task, as needed:
 - [Confirming the AutoLogin Host Identifier for an OAM / OIG Integration](#)
 - [Configuring OAM Security Providers for WebLogic](#)

15.12.4 Confirming the AutoLogin Host Identifier for an OAM / OIG Integration

You can confirm (or configure) Oracle Identity Manager (OIM) automatic login functionality when you have Access Manager integrated with OIM.

Skip this step if you do not have Access Manager 11g integrated with Oracle Identity Manager 11g.

The AutoLogin functionality when Oracle Identity Manager is integrated with Access Manager 11g requires the 10g WebGate Web server host name and port in the list of host identifiers for the IAMSuiteAgent.

Note:

If you have a load balancer in front of the 11g WebGate Web server, you must also include the load balancer's host name and port during Step 3.

The agentBaseUrl parameter is used to update a given Host Identifier. However, if automatic policy creation is set to false, the remote registration utility does not create the Application Domain and does not honor the agentBaseUrl parameter.

The following procedure shows how to confirm (or configure) the AutoLogin host identifier for an Access Manager/Oracle Identity Manager integration. Your values will be different. Before you begin, read [Updating the WebLogic Server Plug-in Configuration](#)

1. From the Policy Configuration tab, Host Identifiers node, and select IAMSuiteAgent.

See Also:

["Searching for a Host Identifier Definition"](#)

2. In the Operations panel, confirm that all host name and port combinations are listed for this Host Identifier.
3. Proceed to ["Configuring OAM Security Providers for WebLogic"](#).

15.12.5 Configuring OAM Security Providers for WebLogic

You can configure the WebLogic Security Providers to ensure Single Sign On using Access Manager 11g and the 10g WebGate.

Skip this step if you do not have Access Manager 11g integrated with Oracle Identity Manager 11g.

Refer to following topics for more information on setting up the security providers for the 11g WebGate.

- [About Security Providers in a WebLogic Server Domain](#)
- [Setting Up Security Providers for the 11g WebGate](#)

15.12.5.1 About Security Providers in a WebLogic Server Domain

To complete the Access Manager 11g SSO configuration when a 11g WebGate is replacing the IAMSuiteAgent requires configuring the security providers in a WebLogic Server domain.

Following are the security providers:

- OAM Identity Asserter: Uses token-based authentication and asserts the OAM SSO header and token.
- OID (or OVD) Authenticator: Creates the Subject and populates it with the correct principals.

Depending on the store where your users are located, you configure either the Oracle Internet Directory Authenticator or the Oracle Virtual Directory Authenticator as the primary credential authenticator.

- **Default Authenticator:** This default WebLogic Authentication provider allows you to manage users and groups in one place: the embedded WebLogic Server LDAP server. This Authenticator is used by the Oracle WebLogic Server to login administrative users:

When you configure multiple Authentication providers, you use the JAAS Control Flag for each provider to control how the Authentication providers are used in the login sequence. You can choose the following the JAAS Control Flag settings, among others:

- **REQUIRED**—The Authentication provider is always called, and the user must always pass its authentication test. Regardless of whether authentication succeeds or fails, authentication still continues down the list of providers. The OAM Identity Asserter is required.
- **SUFFICIENT**—The user is not required to pass the authentication test of the Authentication provider. If authentication succeeds, no subsequent Authentication providers are executed. If authentication fails, authentication continues down the list of providers. Both the Oracle Internet Directory (or Oracle Virtual Directory) and the Default Authenticator are sufficient.
- **OPTIONAL**—When additional Authentication providers are added to an existing security realm, the Control Flag is set to OPTIONAL by default. You might need to change the setting of the Control Flag and the order of providers so that each Authentication provider works properly in the authentication sequence.

The user is allowed to pass or fail the authentication test of this Authentication provider. However, if all Authentication providers configured in a security realm have the JAAS Control Flag set to OPTIONAL, the user must pass the authentication test of one of the configured providers.

See Also:

Configuring Authentication Providers in *Oracle Fusion Middleware Securing Oracle WebLogic Server* for a complete list of Authentication providers and details about configuring the Oracle Internet Directory provider to match the LDAP schema for user and group attributes.

Access Manager JAR are WAR files for authentication providers are available when you install an Oracle Fusion Middleware product (Oracle Identity Management, Oracle SOA Suite, or Oracle WebCenter). If you have a Fusion Middleware application, you already have the files you need.

- **oamAuthnProvider.jar:** Includes files for both the Access Manager Identity Asserter for single sign-on and the Authenticator for Oracle WebLogic Server 10.3.1+. A custom Access Manager AccessGate is also provided to process requests for Web and non-Web resources (non-HTTP) from users or applications.
- **oamauthenticationprovider.war:** Restricts the list of providers that you see in the Oracle WebLogic Server Console to only those needed for use with Access Manager.

When you deploy the extension, the Administration Console creates an in-memory union of the files and directories in its WAR file with the files and directories in the extension WAR file. Once the extension is deployed, it is a full member of the Administration Console: it is secured by the WebLogic Server

security realm, it can navigate to other sections of the Administration Console, and when the extension modifies WebLogic Server resources, it participates in the change control process. For more information, see *Oracle Fusion Middleware Extending the Administration Console for Oracle WebLogic Server*.

15.12.5.2 Setting Up Security Providers for the 11g WebGate

You can set up the security providers using the WebLogic Server Administration Console.

This example illustrates setting up the Oracle Internet Directory provider with the OAM Identity Asserter and Default Authenticator. The steps are the same for OVD, should you need this.

Note:

If you have a Fusion Middleware application, you already have the files you need and you can skip Step 1 of the following procedure. With no Fusion Middleware application, however, you have a stand-alone Oracle WebLogic Server and must obtain the JAR and WAR files from Oracle Technology Network as described in Step 1.

1. **No Oracle Fusion Middleware Application:** Obtain the Access Manager provider:
 - a. Log in to Oracle Technology Network at:

http://www.oracle.com/technology/software/products/middleware/htdocs/111110_fm.html
 - b. Locate the oamAuthnProvider ZIP file with WebGates:

`oamAuthnProvider<version number>.zip`
 - c. Extract and copy oamAuthnProvider.jar to the following path on the computer hosting Oracle WebLogic Server:

`$BEA_HOME/wlserver_10.x/server/lib/mbeantypes/oamAuthnProvider.jar`
2. **With Oracle Fusion Middleware Application Installed:**
 - a. Locate oamauthenticationprovider.war in the following path:

`$ORACLE_HOME/modules/oracle.oamprovider_11.1.2/oamauthenticationprovider.war`
 - b. Copy oamauthenticationprovider.war to the following location:

`$BEA_HOME/wlserver_10.x/server/lib/console-ext/autodeploy/oamauthenticationprovider.war`
3. Log in to the WebLogic Server Administration Console and click **Security Realms**, *Default Realm Name*, and click **Providers**.
4. **OAM Identity Asserter:** Perform the following steps to add this provider:
 - a. Click Authentication, click New, and then enter a name and select a type:

Name: *OAM ID Asserter*

Type: **OAMIdentityAsserter**

OK

- b. In the Authentication Providers table, click the newly added authenticator.
 - c. Click the Common tab, set the Control Flag to **REQUIRED**, and click Save
5. **OID Authenticator:** Perform the following steps to add this provider.
- a. Click **Security Realms, Default Realm Name**, and click **Providers**
 - b. Click New, enter a name, and select a type:
 Name: *OID Authenticator*
 Type: OracleInternetDirectoryAuthenticator
 OK
 - c. In the Authentication Providers table, click the newly added authenticator.
 - d. On the Settings page, click the **Common** tab, set the Control Flag to **SUFFICIENT**, and then click Save.
 - e. Click the **Provider Specific** tab and specify the following required settings using values for your own environment:
 Host: Your LDAP host. For example: *localhost*
 Port: Your LDAP host listening port. For example: *6050*
 Principal: LDAP administrative user. For example: *cn=orcladmin*
 Credential: LDAP administrative user password.
 User Base DN: Same searchbase as in Access Manager.
 All Users Filter: For example: *(&(uid=*)(objectclass=person))*
 User Name Attribute: Set as the default attribute for username in the LDAP directory. For example: *uid*
 Group Base DN: The group searchbase (same as User Base DN)
 Do not set the All Groups filter as the default works fine as is.
 Save.
6. **Default Authenticator:** Perform the following steps to set up the Default Authenticator for use with the Identity Asserter:
- a. Go to **Security Realms, Default Realm Name**, and click **Providers**.
 - b. Click Authentication, Click **DefaultAuthenticator** to see its configuration page.
 - c. Click the Common tab and set the Control Flag to **SUFFICIENT**.
 - d. Save.
7. **Reorder Providers:**
- a. Click **Security Realms, Default Realm Name, Providers**.
 - b. On the Summary page where providers are listed, click the **Reorder** button

- c. On the **Reorder Authentication Providers** page, select a provider name and use the arrows beside the list to order the providers as follows:
 - OAM Identity Asserter (REQUIRED)
 - OID Authenticator (SUFFICIENT)
 - Default Authenticator (SUFFICIENT)
 - d. Click OK to save your changes
8. **Activate Changes:** In the Change Center, click Activate Changes
 9. Reboot Oracle WebLogic Server.
 10. Proceed as follows:
 - **Successful:** Go to "[Disabling IAMSuiteAgent](#)".
 - **Not Successful:** Confirm that all providers have the proper specifications for your environment, are in the proper order, and that `oamAuthnProvider.jar` is in the correct location as described in "[About Security Providers in a WebLogic Server Domain](#)".

15.12.6 Disabling IAMSuiteAgent

This step is optional, not required. IAMSuiteAgent detects when the WebGate has performed the authentication and then goes silent. However, if the agent must be disabled, then either the WLSAGENT_DISABLED system property or environment variable must be set to true for each one of the servers on which the agent should be disabled. This applies to both AdminServer and OAM Servers.

You can disable the agent in one of two ways:

- Either set the WLSAGENT_DISABLED environment variable to true
- Or pass WLSAGENT_DISABLED as a System Property

Before you begin: [Configuring OAM Security Providers for WebLogic](#), if needed.

1. On the computer hosting the IAMSuiteAgent, perform one the following tasks:
 - Either set the WLSAGENT_DISABLED environment variable to true:

```
setenv WLSAGENT_DISABLED true
```
 - Or pass DWLSAGENT_DISABLED=true as a System Property:

```
-DWLSAGENT_DISABLED=true
```
2. Restart the Web server.
3. Proceed with "[Configuring Centralized Logout for 11g WebGates](#)", then return to "[Verifying the Webgate Configuration](#)".

15.12.7 Verifying the Webgate Configuration

Oracle recommends testing your environment using the 11g WebGate to ensure that all applications that were previously protected by the IAMSuiteAgent are now protected after configuration.

Before you begin: "[Configuring Centralized Logout for 11g WebGates](#)"

See Also:

- ["Validating Authentication and Authorization in an Application Domain"](#)
 - [Validating Connectivity and Policies Using the Access Tester](#)
-

15.13 Managing the Preferred Host in 10g WebGates

In previous 10g releases, the preferred host was a mandatory parameter which could be made optional through configuration. In the current implementation of Access Manager, the value of the preferred host parameter in the agent profile is a mandatory field populated when the profile is created. Thus when migrating agent profiles from Access Manager 10g, this parameter might have no value. Because of the empty preferred host value in a migrated agent profile, the Access Manager 11g console does not allow the administrator to modify the agent profile.

Since the current migration process does not support migration when this parameter is empty, the following actions have been incorporated into the migration process.

- During the migration of agent profiles with no preferred host value, the host identifier defined as the value of `AUTO_UPDATE_HOSTID` will be set as the preferred host. This will work for 11g WebGates as well as 10g WebGates.

Note:

In the `getClientConfigResponse()` method, the `AUTO_UPDATE_HOSTID` host identifier will be replaced with an empty string so that the preferred host will not be set in `ObAccessClient.xml`. In these cases, the WebGate will read the host from the HTTP header. Because the user can modify the HTTP header, this vulnerability is indicated as follows.

- The 11g Access Manager console displays the agent profile with a red mark indicating that the value of the preferred host is blank.
 - The agent's `GetClientConfig()` method indicates that the empty preferred host is null.
-
- The `ALLOWBLANKPREFERREDHOST` flag will be added and action taken based on its value. In cases where it is set to true, the empty string will be sent to the agent as the preferred host. In cases where it is set to false, the server will send a fatal error to the agent.

Use the [setAllowEmptyHostIdentifier](#) WLST command, described in the following section, to manage this feature.

15.14 setAllowEmptyHostIdentifier

Enables and disables the use of an empty preferred host parameter.

Description

Enables or disables the use of an empty preferred host parameter. The following parameters (added to the `oam-config.xml` file) will be set to enable or disable an empty preferred host parameter in the `ObAccessClient.xml` file.

```
<Setting Name="AutoUpdateHostIdentifier"
  Type="xsd:string">AUTO_UPDATE_HOSTID</Setting>
<Setting Name="AllowEmptyHostIdentifier"
  Type="xsd:boolean">true</Setting>
```

Syntax

```
setAllowEmptyHostIdentifier(enable="true/false")
```

Argument	Definition
<i>enable</i>	Set to true or false to allow for an empty host identifier or not.

Sample

```
setAllowEmptyHostIdentifier(enable ="true")
```

Maintaining Access Manager Sessions

An Access Manager session is created during authentication and bound to both the user and the client with which the user has authenticated. Access Manager sessions are maintained to provide tracking and policy enforcement (performed either manually by an Administrator or using automated flows) for a given session's lifecycle.

The Access Manager session lifecycle consists of state transitions for session creation, updates, idleness, and expiration.

The following topics describe concepts and procedures for Access Manager sessions:

- [Introducing Access Manager Session Management](#)
- [Understanding Server-Side Session Management](#)
- [Server-Side Session Enforcement Examples](#)
- [Configuring the Server-Side Session Lifecycle](#)
- [Managing Active Server-Side Sessions](#)
- [Validating Server-Side Session Operations](#)
- [Understanding Client-Side Session Management](#)
- [Using WLST To Configure Session Management](#)

16.1 Introducing Access Manager Session Management

With this 11gR2 PS2 release of Oracle Access Management, Access Manager sessions can be managed from either the server side or the client side.

The Server-side and client-side Session Management options are described as follows:

- Server-side session management (also referred to as Coherence-based session management) is the default session management option developed for Access Manager. It allows for advanced session management across nodes via Coherence-based caching. Offering reliable performance and advanced features (including impersonation, session sniping, identity context propagation and the like), server side session management is recommended for most deployments - especially internal ones where rich session management features are desired.

See the following topics for more details:

- ["Understanding Server-Side Session Management"](#)
- ["Server-Side Session Enforcement Examples"](#)
- ["Configuring the Server-Side Session Lifecycle "](#)

- ["Managing Active Server-Side Sessions"](#)
- ["Validating Server-Side Session Operations"](#)
- Client-side session management (also referred to as cookie-based session management) manages sessions using browser cookies; it is essentially stateless. Client side session management offers higher performance with a lightweight footprint when compared to the Coherence-based option. It stores session details in the browser cookie with no information saved on the server-side and is most appropriate for very large deployments where advanced server-side session management features are not needed.
See ["Understanding Client-Side Session Management"](#).

Note:

Cookie-based sessions can be accessed only from a browser request context and not directly from the server.

Follow the instructions in the following topics on how to configure the session management option: See ["Using WLST To Configure Session Management"](#).

16.2 Understanding Server-Side Session Management

The following topics provide an overview of server-side session management:

- [About Securing Access Manager Sessions](#)
- [Access Manager Session Lifecycle, States, and Enforcement](#)
- [Access Manager Sessions and the Role of Oracle Coherence](#)

16.2.1 About Securing Access Manager Sessions

Session security begins with a secure installation.

For installation details see the *Oracle Fusion Middleware Installation Guide for Oracle Identity and Access Management*.

See Also:

Administering Oracle Fusion Middleware for details about configuring secure communications between Oracle Fusion Middleware components using SSL.

The HTTPS protocol, Oracle Coherence and database encryption are some of the ways in which Access Manager supports server-side session security. The following list describes how this support can work.

- HTTPS Protocol
Access Manager helps prevent session fixation by providing IP address checks by the Proxy. To further help prevent session fixation, be sure to use the secure HTTPS protocol for communication between WebGates and OAM Servers.
- Oracle Coherence

Data is not encrypted in-memory; however, data is protected over the wire. Oracle Coherence communicates between the different Access Manager instances on various servers, and this communication is secured in the following ways.

- Coherence supports communication only between hosts that have been previously identified. This is done as a range of IP addresses, or by specific host names. Access Manager configuration files contain entries for each server that participates in the communication. During startup, this information is provided to Coherence ensuring that only authorized servers participate in the communication.
- Coherence uses mutually-authenticated SSL between all servers in the cluster. The jceks keystore file, which holds the applicable keys and certificates, is created during installation.

See "[Access Manager Sessions and the Role of Oracle Coherence](#)" as well as the Oracle Coherence documentation.

- Database Encryption

The Session Management Engine does not encrypt data. For security concerns, use an in-database encryption such as Oracle Advanced Security.

16.2.2 Access Manager Session Lifecycle, States, and Enforcement

The session lifecycle refers to a set of states with defined transitions from one state to another that depend on user activity (or lack thereof), and manual (or automated) Administrator activity.

Administrators can define the following global session lifecycle settings:

- Session Lifetime
- Idle Timeout
- Maximum number of Sessions
- Database Persistence of Active Sessions

Note:

Idle Timeout can also be implemented as application-specific settings, as described later.

[Table 16-1](#) lists the Session lifecycle states.

Table 16-1 Session Lifecycle States

State	Description
Active	<p>Newly-created sessions are active. A session is created when the user is authenticated by Access Manager.</p> <p>The session remains active until Access Manager determines that the session must transition into one of the other states in this table.</p> <p>Note: Administrators can delete only active sessions.</p>

Table 16-1 (Cont.) Session Lifecycle States

State	Description
Idle	An active session becomes idle when the user does not access Access Manager-protected content for the period defined by an Administrator. When an active session becomes idle, the user must re-authenticate to proceed. When re-authentication is successful, the session returns to the Active state; session attribute values are preserved through this process.
Expired	An active session expires when the duration of the session exceeds the defined lifetime. An expired session is completely inaccessible and eligible for deletion. When an active session expires, the user must re-authenticate to proceed. When re-authentication is successful, a new session is created; however, session attribute values are not preserved (as they are for Idle states).

See the following topics for more information about:

- [Global Session Enforcement Checks for State Changes](#)
- [Access Manager Session Removal](#)
- [About Step-Up and Step-Down Authentication and Credentials](#)
- [Optional Application-Specific Session Enforcement](#)
- [About Timeout with Multiple-Agent Types: OSSO and OAM Agents](#)
- [About OpenSSO Agents](#)

16.2.2.1 Global Session Enforcement Checks for State Changes

Each Access Manager session holds two time attributes and applicable values.

Following are the two time attributes:

- Session creation time
- Last access time

The values of these attributes are compared for session enforcement as described in "Table 16-2".

Table 16-2 Session Checks for State Changes

Session Check	Description
Is the Session Idle?	Compares the last access time against the configured Idle Timeout value. Exceeding the configured period triggers a change from the Active to the Idle state.
Is the Session Expired?	Compares the session creation time against the configured Session Lifetime. Exceeding the configured period triggers a change from the Active to the Expired state.

During transitions to the Idle state, underlying session attributes are preserved because the user previously satisfied authentication criteria and the data is trusted. However, continued access to protected resources based on that session, and resulting

modification of data within that session, is not allowed until the user re-authenticates, proving not to be a malicious user with access to an unlocked computer.

16.2.2.2 Access Manager Session Removal

A session can be removed by three actions: expiration, user logout, and termination.

Session removal actions are described in [Table 16-3](#).

Table 16-3 Session Removal

Action	Description
Expiration	Expired sessions are eligible for removal based on their creation time. Actual removal is determined by the storage mechanism. The session is removed from the distributed cache using a background task running on the server; it is removed from the database using a similar background task, an optionally-enabled job within the database itself, or both methods in combination. Once a session has been deleted from storage on all tiers (local and distributed caches, and from the database if enabled), the session is removed.
User Logout	User Logout triggers immediate removal from the distributed cache, subject to present volume of DB session writes and performance.
Termination	Termination is identical to user log out whether the session is interactively terminated through the Administration Console or in an automated way--as part of an Oracle Identity Management user lockout or de-provisioning flow.

16.2.2.3 About Step-Up and Step-Down Authentication and Credentials

On occasion, multiple forms of authentication are required and performed within a single session to complete a step-up flow. A re-authentication level might be a step down from the session.

In a step-up flow, a user authenticates to access protected content and later in the same session, the user requests other, more sensitive content and is required to authenticate again to access it at a more stringent level. In a step-up flow, multiple authentications always occur in order of the increasing authentication level. Each session holds the Authentication Level attribute for step-up authentication enforcement.

If the re-Authentication Level is less than that previously contained in the session, the user has completed a step-down process. Upon successful re-authentication, the session is restored to the Active state with an Authentication Level that is equal to the lower level of the authentication scheme used. If the user later attempts to access content that is protected at a higher level, step-up authentication occurs.

16.2.2.4 Optional Application-Specific Session Enforcement

Access Manager enforces limitations on user access to resources in a more granular way than is possible with a single set of global session timings, or single set of authentication schemes in which access depends solely on a single authentication level. Access to certain data has more stringent requirements, while access to all other data is configured globally.

Administrators can choose to override global session timeout settings on a per application basis, defined as part of Application Domain settings. Optional application-specific session configuration provides:

- The ability to declare session idle timings on a per-application basis, which is generally more stringent than the global idle timing defined within the deployment as a whole.
- The ability to require the user to re-authenticate after a per-application session inactivity timeout.

[Table 16-4](#) describes session enforcement when you have defined Application Domain-specific overrides to global session settings.

Table 16-4 Application Domain-Specific Overrides

Override	Description
Is the Session Idle?	Compares the last access time against the configured Idle Timeout value for the defined Application Domain only. Exceeding the configured period triggers a change from the Active to the Idle state.
Is the Session Expired?	Compares the session creation time against the configured Session Lifetime. Exceeding the configured period triggers a change from the Active to the Expired state for the defined Application Domain group only.

16.2.2.5 About Timeout with Multiple-Agent Types: OSSO and OAM Agents

The idle timeout is applied appropriately even if the session is operating in a disconnected state. (A disconnected state occurs if `mod_osso` requests are being made but not by the WebGate. In this case, the session appears to have idled out to the server.) To enable global logout for the OSSO Agent, the Session Management Engine reconciles a period of inactivity with the OAM Agent against a period of activity with the OSSO Agent.

`mod_osso` agents support granular timeout only if the Global Inactivity TimeOut feature is enabled (using the `editGITOvalues WLST` command). The `OAM_GITO` cookie is needed in special cases to support timeout with multiple types of agents working with OAM Server (such as `mod_osso` and WebGate). If a user leaves an active session (with an OAM Agent), starts a session with an OSSO Agent, and then returns to the initial session (with the OAM Agent, now inactive), the Session Management Engine reconciles the period of inactivity with the OAM Agent against the period of activity with the OSSO Agent to enable global logout for the OSSO Agent.

Note:

Oracle strongly recommends that you change the value of the Idle Timeout parameter when using the OAM_GITO cookie:

1. Login to the OAM Console as administrator.
2. Click the System Configuration tab.
3. Click Common Settings.
4. Change the value for the Idle Timeout parameter (in the Session section) so that it matches the value of the OAM_GITO cookie as defined.

The OAM_GITO cookie is enabled and configured using the `editGITOvalues WLST` command. For details, see the *Oracle Fusion Middleware WebLogic Scripting Tool Command Reference for Identity and Access Management*.

16.2.2.6 About OpenSSO Agents

In the context of session management, OpenSSO agents are equivalent to WebGates.

Unlike `mod_osso`, OpenSSO Agents do not operate in a disconnected state.

16.2.3 Access Manager Sessions and the Role of Oracle Coherence

Access Manager sessions can be configured as Persisted or Distributed sessions.

The default Access Manager configuration is the Persisted Sessions but you can use the Oracle Access Management Console to change this.

- When Access Manager is configured for Persisted Sessions, all user sessions are stored in a backing database and are available across server restarts. Recently created sessions and the most frequently used sessions will also be stored in memory in the Coherence cache. The sessions are written out to the database in a batched mode in an asynchronous thread, enabling faster latencies during session creation and updates. When requested by the server, the Coherence cache transparently fetches either its local copy or the copy stored in the backing database based on the number of cache hits at the time. The size of the in-memory cache can be small enough to accommodate active sessions. The size of the Coherence cache is configurable; by default, it is defined as 100 MB.
- When Access Manager is configured for Distributed Sessions, the user sessions are stored only in the in-memory Coherence Cache. These sessions are not available across server cluster restarts. However if any specific node is stopped, the backup sessions of that node will be used. The total sessions retained are restricted to the size of the Coherence cache - configurable using the Oracle Access Management Console. If more users login than can be stored in the cache, the oldest non-active sessions are deleted from the cache. A user whose session has been deleted from the cache will have to login again to be recognized and granted access to protected resources.

The Coherence cache size required for either of the described configurations is calculated using the following formula.

$$S = N * (1 + b) * s / n$$

- S is the size of heap to be allocated to the Coherence Session cache per OAM server. The size of the heap allocated to sessions per OAM node may be updated in the OAM configuration file under the Setting element name DistributedCacheMaxSize. This update to the configuration requires, at the least, a rolling restart of the servers.
- N is the maximum number of sessions to be stored in the cache.
- b is the number of backup copies.
- s is the average size of a session object. The average size of a session object may vary based on attributes and responses that are stored in the session. This value may be discovered in any installation by examining the Coherence mbeans for backing store of SmeNearCache cache.
- n is the number of OAM server nodes that participate in the cluster.

16.3 Server-Side Session Enforcement Examples

Satisfying the authentication scheme of a given level provides access to all resources protected at lower levels. Additionally, all authentication schemes of a given level are viewed as equivalent.

This section provides a simple session enforcement example based on a single authentication scheme used in two application domains as well as a more complex example based on multiple authentication schemes used in two application domains.

- [Example 1: Single Authentication Scheme](#)
- [Example 2: Multiple Authentication Schemes](#)

16.3.1 Example 1: Single Authentication Scheme

Consider the following configuration:

- A single authentication scheme (S1) defined using Level 2
- Application domains D1 and D2
- All resources within each domain are protected with a single authentication policy, which uses S1, and a single authorization policy.
- Global Session Configuration:
 - Session Lifetime: 90 minutes
 - Idle Session Timeout: 0 (session never idles out)
 - Application Domain Timeout: 30 minutes

Now consider the outcomes in [Table 16-5](#).

Table 16-5 Session Content: Single Authentication Scheme

Time (Delta)	Action	Access Allowed or Denied	Session Content
0	Access to D1	Denied due to no session	null

Table 16-5 (Cont.) Session Content: Single Authentication Scheme

Time (Delta)	Action	Access Allowed or Denied	Session Content
1	Authentication with S1 and Access to D1	Allowed because Authentication scheme is satisfied	Level 2, authentication time 1
21	Access to D2	Allowed	Level 2, authentication time 1
66	Access to D1	Denied due to Application Domain Timeout (based on the parameters configured)	Level 2, authentication time 1
67	Authentication with S1 and Access to D1 and D2	Both Allowed because the Authentication Scheme is satisfied	Level 2, authentication time 67

16.3.2 Example 2: Multiple Authentication Schemes

In previous releases of Access Manager, a session could only have its authentication level reduced in the context of an Oracle Identity Management integration self-service flow (such as forced password reset). In this release, step-down authentication occurs when a session times out as a matter of course--until the user happens to provide new credentials that satisfy a scheme of the same level as the maximum held by the session previously. Otherwise, from the authentication perspective, it is as if the session is new and further step-up is required. Consider this example with two authentication schemes (for step-up and step-down).

- Authentication schemes S1 (Level 2) and S2 (Level 3)
- Application domains D1 and D2
- All resources within each domain are protected with a single authentication policy, and a single authorization policy
- D1 uses S1; D2 uses S2
- Global Session Configuration:
 - Session Life: 240 mins
 - Idle Timeout: 30 mins
 - Appdomain 2 (D2) Timeout: 15 mins (appdomain setting)

When accessing resources from D1, timeout will occur after 30 minutes (global timeout setting); D2 timeout will happen after 15 mins since its timeout value is overridden at the global level. [Table 16-6](#) shows the resulting outcomes.

Table 16-6 Session Outcomes: Multiple Authentication Schemes

Time (Delta)	Action	Access Allowed or Denied	Session Content
0	Access D1 resource (RD1)	Access allowed after successful login	Timeout for D1 will be set to $0+30=30$ (30 is default global timeout as D1 has not overridden timeout at the Application Domain level)
1 (implies after 1 minute)	Access D2 resource (RD2)	Access allowed post credential challenge (user will be prompted for credentials since D2 is protected using a higher authentication scheme)	Timeout of D2 will be set to $1+15=16$
$t > 16$ and $t < 30$ (say $t = 20$)	Access RD1 and RD2	Allowed access to RD1 because timeout of $D1=30$. Allowed access to RD2 after providing credentials since timeout of $D2=16$	The new timeout of D2 is 16
40	Access RD1	Allowed: D1 resource will be allowed since timeout is 50	
55	Access RD1 and RD2	Allowed to access both resources after user is successfully challenged for credentials.	Timeout of D1 is now 85 ($55+30$) Timeout of D2 is now 70 ($55+15$)

The access order does have an impact on the outcome. For instance, the last D1 access could have been allowed if the user had chosen to first pursue access to the D2 application after credentials had expired. For example:

- Authentication S2 with Access to D2 Allowed: L3 scheme satisfied; resulting level of the now (again) active session same as before. Session Content: Level 3, authentication time 51
- Access to D1 Allowed: Level 3 credentials also sufficient for Level 2-protected access. Session Content: Level 3, authentication time 51.

16.4 Configuring the Server-Side Session Lifecycle

Session Lifecycle settings can be defined using the Oracle Access Management Console. When you define either global or application-specific session lifecycle settings, any timing interval set to 0 cancels the corresponding check.

For example if idle timeout is set to 0, sessions never idle out. With a session lifetime of 0, sessions never expire. In all cases, applicable data is tracked and updated in the session, just as if it is being checked on a per-request basis.

This section provides the following topics:

- [Global Session Lifecycle Settings](#)
- [Application-Specific Session Overrides](#)
- [Viewing or Modifying Global Session Settings](#)
- [Viewing or Modifying Optional Application-Specific Session Overrides](#)

16.4.1 Global Session Lifecycle Settings

Access Manager session lifecycle settings are defined as part of the Common Settings shared by all OAM Servers.

Figure 16-1 shows the lifecycle attributes that you can configure on the Common Settings page.

Figure 16-1 Global Session Details: Common Settings Page

▲ Session

* Session Lifetime (minutes)	480	▲	▼	* Maximum Number of Sessions per User	8	▲	▼
* Idle Timeout (minutes)	15	▲	▼	Database Persistence of Active Sessions	<input checked="" type="checkbox"/>	Enabled	
* (Management) Maximum Search Results	100	▲	▼				

Table 16-7 describes the global session lifecycle settings and their defaults. Sessions can operate in a disconnected mode (mod_osso, for example). Therefore, changes to the configuration establishing your session rules apply only to new sessions. To apply changes immediately, Oracle recommends that you terminate existing sessions and force users to create new ones that adhere to your new rules.

See Also:

Tuning Performance

Table 16-7 Global Session Settings

Setting	Description
Session Lifetime (minutes)	<p>The amount of time, in minutes, that a user's authentication session remains active. When the lifetime is reached, the session expires.</p> <p>Default = 1440 minutes (24 hours specified in an integer representing minutes)</p> <p>A value of zero (0) disables this setting. Any value between 0 (zero) and 2147483647 is allowed.</p> <p>Note: An expired session is automatically deleted from the in-memory caches (or database).</p>
Idle Timeout (minutes)	<p>The amount of time, in minutes, that a user's authentication session remains active without accessing any Access Manager protected resources. When the user is idle for a longer period, they are asked to re-authenticate.</p> <p>Default = 15 minutes</p> <p>A value of zero (0) disables this setting. Any value between 0 (zero) and 2147483647 is allowed.</p> <p>Note: Timed-out sessions are not deleted from the session manager. Session data could be removed from memory but will still be available in the persistent store (database). After re-authentication, the same session will be re-activated.</p> <p>See Also: "Application-Specific Session Overrides"</p>

Table 16-7 (Cont.) Global Session Settings

Setting	Description
Maximum Number of Sessions per User	<p>The exact number of sessions each user can have at one time. Use this setting to configure multiple session restrictions for all users.</p> <p>Any positive integer is allowed.</p> <p>Specifying the count as "1", activates a special mode. If a user who already has a session authenticates using another device (thereby creating a new session), then their existing session is deleted. No error is reported and no warning is given.</p> <p>Note: Too high a number impacts performance and result in a security risk. Oracle recommends less than 20 as a reasonable limit per user. Otherwise there can be performance impact. For tuning information, see <i>Tuning Performance</i>.</p>
(Management) Maximum Search Results	<p>Maximum number of sessions fetched by default for a session query if the result set is large.</p>
Database Persistence for Active Sessions Enabled	<p>Persists active sessions to the configured database session store, in addition to the local and distributed caches. Sessions are retained even if all managed servers die off.</p> <p>Default = Enabled (checked)</p> <p>If this is overkill for your environment, or you want to perform deployment sizing to take into account the database, you can clear the checkbox and restart all OAM Servers to disable this function.</p>

16.4.2 Application-Specific Session Overrides

Application-specific access is tracked from the initial application-access time and is updated only as further requests are made of that Application Domain.

In other words, the user's authentication and the authentication state are under control of Access Manager and the Administrator. The current idle time for a given application is shared between Access Manager and the application. The application provisions its own run time data for the user on a per-session basis and needs to remove it as soon as possible to make room for others.

Administrators can add application-specific session overrides on the Summary tab of an Application Domain. [Table 16-8](#) lists application-specific settings that, when specified, override global session settings.

Table 16-8 Application-Specific Session Timing Overrides

Element	Description
Idle timeout	<p>Access Manager previously stored the last access time value within the session. To enforce maximum idle time on a per-application basis, Access Manager includes a new application-specific last access time field to hold it. This is filled with the last access time for each subset of domains visited within the course of a session, on which a per-application idle timeout override has been defined. This is not needed for domains on which an override has not been defined--no checking is done against such data.</p> <p>Default: undefined</p> <hr/> <p>Note: When the app domain timeout value is less than the global session timeout value and it is more restrictive, the app domain idle timeout overrides the global session idle timeout. When it is greater than global session timeout, OAM session timeout is based on the Global Settings value.</p>

For more information, see "[Viewing or Modifying Optional Application-Specific Session Overrides](#)".

16.4.3 Viewing or Modifying Global Session Settings

Users with valid Administrator credentials can to modify common session lifecycle settings using the Oracle Access Management Console.

For more information, see "[Global Session Lifecycle Settings](#)".

1. In the Oracle Access Management Console, click Configuration at the top of the window.
2. In the Configuration console, select **Common Settings** from the **View** menu in the **Settings** section.
3. On the Common Settings page, expand the **Session** section.
4. Click the arrow keys beside each list to increase or decrease session lifecycle settings as needed ([Table 16-7](#)):
 - Session Lifetime (minutes)
 - Idle Timeout (minutes)
 - Maximum Number of Sessions per User
 - (Management) Maximum Search Results - denotes the number of sessions fetched by default for a session query if the result set is large
 - Database Persistence of Active Sessions Enabled
5. Check the box to enable **Database Persistence for Active Sessions**.
6. Click **Apply** to submit the changes (or close the page without applying changes).

7. Close the page when you finish.
8. Proceed to one of the following topics:
 - ["Viewing or Modifying Optional Application-Specific Session Overrides"](#)
 - ["Managing Active Server-Side Sessions"](#)

16.4.4 Viewing or Modifying Optional Application-Specific Session Overrides

Users with valid Administrator credentials can modify optional session settings for one or more application domains in a named group.

For more information, see ["Application-Specific Session Overrides"](#).

1. In the Oracle Access Management Console, click **Application Security** at the top of the window.
2. In the Access Manager section, click **Application Domains**.
3. Find and open the desired domain.
4. On the Summary tab, enter the following information to create (or add) this domain to the group that uses session overrides ([Table 16-8](#)):
 - Idle Timeout
5. Click **Apply** to submit the changes (or close the page without applying changes).
6. Proceed to ["Managing Active Server-Side Sessions"](#).

16.5 Managing Active Server-Side Sessions

Session Management page provides Search controls that enable Administrators to create a query based on filter conditions, save their Search Criteria for use later, and add fields to the query form to further refine the search. The Oracle Access Management ConsoleIn the database store configuration, the session might exist in the database but not in the cache. Session searches are based on the system time stamp. The database is queried for sessions updated earlier than the time stamp (minus the write delay). The cache is queried for sessions updated later than this time stamp. Resulting data found in the cache and the database is merged. If duplicate results exist, cache data prevails. Detailed performance metrics are generated for search operations.

This section describes how to locate and delete one or more sessions for a single user, or for all users. It provides the following information:

- [Session Management Controls](#)
- [Locating and Managing Active Sessions](#)

16.5.1 Session Management Controls

The Session Management page is accessible from the Configuration section of the Oracle Access Management Console.

[Figure 16-2](#) illustrates the Session Management page. Additional details follow the figure.

Figure 16-2 Common Configuration: Session Management Page

The screenshot shows the 'Session Management' page in the Access Manager interface. At the top, there's a 'Delete All User Sessions...' button. Below it, a search section allows filtering by 'User ID' and 'Client IP Address', each with a 'Starts with' dropdown and an input field. Action buttons for 'Search', 'Reset', 'Add Fields', and 'Reorder' are present. A toolbar includes 'View', 'Delete', and 'Detach' options. The table below has columns: Row, User ID, Session ID, Impersonating, Creation Instant, Last Access Time, Last Update Time, and Client IP Address. The table content is empty, showing 'No Data available'.

Table 16-9 describes Session Management page and Search controls that enable you to create a query that is based on filter conditions.

Table 16-9 Session Management Controls and the Results Table

Name	Description
Delete All User Sessions ...	Choose this command button to delete the active sessions of all users. Note: A Confirmation window appears where you can confirm or decline the operation.
Saved Search	Drop down menu that lists any search criteria saved previously for reuse. The list of searches is made available whenever you save search criteria. The drop down menu also has a Personalize ... option in addition to the saved searches. If you choose Personalize, you can change the behavior of the saved search criteria by making new choices such as Set as Default or Run Automatically.
Match All Any	Enables you to match either any of the criteria you have specified or match all of the criteria you have specified during the search. Note: When a resource is protected by <code>AnonymousScheme</code> , it is not displayed in a session search.
User ID	Enter a specific userID in the field and then click the Search button to display all active sessions for this user. Incomplete strings and wild cards are allowed. A drop down menu includes options like Starts With, Equals, Contains and the like to assist in your search.
Client IP Address	Enter a Client IP Address and then click the Search button to display all active sessions for this user. Incomplete strings and wild cards are allowed. The same list is available to assist your Userid search and your Client IP Address.
Search	Click this button to initiate a search based on criteria in the form.
Reset	Click this button to clear the form of all criteria.

Table 16-9 (Cont.) Session Management Controls and the Results Table

Name	Description
Add Fields	<p>Displays a drop down menu from which you can select different options to add to your search form. This can include Client IP Address, ID Store, Impersonating and other options.</p> <ol style="list-style-type: none"> 1. Click the Add Fields button. 2. Select items in the list to add them to the form and click Save. <p>After adding an item, notice that a list is available to assist with the search.</p>
Reorder	<p>Displays a pop-up dialog allowing you to reorder the search fields.</p>
View	<p>Choose commands from the View menu above the results table to configure the table. Commands include:</p> <ul style="list-style-type: none"> • Columns: Displays a menu with the following options you can use to hide or display specific details in the table: • Detach: Expands the results table to a full-screen view • Attach: Restores the Session Management page view. • Reorder Columns: Specifies a new order for columns containing session data in the results table.
Delete	<p>Choose this command button (red X) after selecting items in the results table to delete.</p> <p>Note: When session search criteria is generic (using just a wild card (*), for example), there is a limitation on deleting a session from a large list of sessions. Oracle recommends that your session search criteria is fine-grained enough to obtain a relatively small set of results (ideally 20 or less).</p> <p>Also: A Confirmation window appears where you can confirm or decline the operation.</p>
Detach	<p>Click Detach to expand the results table to a full-page view.</p> <p>Note: If the table is already a detached full-page, click Detach to restore the Session Management page.</p>
Results table (not named)	<p>After searching for the active sessions of a specific user, results are displayed in the table. Details include:</p> <ul style="list-style-type: none"> • Session ID: A unique, OAM-generated session Id. • User ID: • Impersonating: • Creation Time: The day and time the session was created. • Last Accessed: The day and time the session was last accessed • Client IP: The IP address of the specified user. • ID Store • Impersonator

16.5.2 Locating and Managing Active Sessions

Users with valid Administrator credentials can configure the search results table, locate the active sessions of a specific user, delete one or more sessions for a specific user, or delete all sessions for all users.

When a resource is protected by AnonymousScheme, it is not displayed in a session search.

See Also:

["Session Management Controls"](#)

Skip any steps that do not apply to your requirements. The OAM Server must be running.

1. In the Oracle Access Management Console, click **Application Security** at the top of the window.
2. In the Application Security console, click **Session Management**.
The Session Management Search page appears with the Username field and a results table.
3. **Add Fields:** From the Add Fields list, choose the desired field name ([Table 16-9](#)).
4. **Choose Operators:** Open the list of operators for the chosen search field, and choose the desired function.
5. **Find sessions:**
 - a. In the desired query field, enter your criteria (with or without a wild card (*)).
 - b. Click the **Search** button to locate sessions that match either any or all your criteria.
 - c. Review the results table.
 - d. Repeat if needed to further refine your search.
6. **Configure the Results Table:** Use functions on the View menu to create the desired results table.
7. **Delete sessions:**
 - a. In the results table, click one or more sessions to remove.
 - b. Click the **Delete (x)** button to delete the selected sessions.
 - c. Click **Yes** to confirm deleting selected sessions (or click **No** to cancel the delete operation).
 - d. Notify the user, if needed.
8. **Delete sessions for all users:**
 - a. Click the **Delete All Sessions** button in the upper-right corner.

- b. Click **Yes** when you are asked to confirm.
9. Close the Session Management page when you finish.
10. Proceed to "[Validating Server-Side Session Operations](#)".

16.6 Validating Server-Side Session Operations

You can verify your configured session lifecycle operations.

1. Authenticate:
 - a. Access a resource from a browser using a credential other than your Administrative credential.
 - b. Verify that the session exists, as described in "[Locating and Managing Active Sessions](#)".
2. Multiple Sessions:
 - a. From a second browser (with cookies removed), access the same resource.
 - b. Verify that two sessions exist.
3. Delete all sessions, (Step 7 of "[Locating and Managing Active Sessions](#)") and confirm that the Active sessions are removed.
4. Re-authentication Verification:
 - a. From the second browser (Step 2), access a different resource to confirm that you must re-authenticate.
 - b. Enter credentials for the resource.
 - c. Verify that a session was created.
5. Database Verification:
 - a. Delete all sessions.
 - b. Connect to the database and run the following query:

```
SQL> select * from oam_session
```
 - c. Confirm that you see the following results:

```
no row selected
```
 - d. From the second browser, access a different resource.
 - e. Connect to the database and run the following query

```
SQL> select * from oam_session
```
 - f. Confirm that you see one row of data:

```
1 rows selected
```
 - g. Select rows from OAM_SESSION_ATTRIBUTES and confirm that data exists for the user.

16.7 Understanding Client-Side Session Management

Client-side (or cookie-based) session management is a light weight session management solution that reduces server-side overhead and provides better scalability.

It uses client-side cookies as the persistent mechanism for SSO sessions, making the server stateless. Client-Side session management supports the following features:

- Authentication
- Authorization (excluding session constrains and responses)
- OAM & OIM integration over TAP - excluding session deletion on attribute change (account lock/disable, etc.)
- Step up authentication
- Inactivity time out with single web domain

16.8 Using WLST To Configure Session Management

The following WLST commands can be used to configure for server-side (default) or client-side (cookie-based) session management.

- [displaySSOSessionType](#)
- [configSSOSessionType](#)

16.8.1 displaySSOSessionType

Online and offline command that allows you to view the session management configuration.

Description

Allows you to view the session type configuration.

Syntax

```
displaySSOSessionType(domainHome="<domainHome>")
```

Argument	Definition
<i>domainHome</i>	Specifies the location for the Weblogic Server OR Cell Path for WebSphere. This parameter is mandatory for WebSphere. When Offline, a value is mandatory; when online, optional.

Sample

```
displaySSOSessionType(domainHome="/oracle/product/OAM/domains/oam_domain")
```

16.8.1.1 Description

Allows you to view the session type configuration.

16.8.1.2 Syntax

```
displaySSOSessionType(domainHome="<domainHome>")
```

Argument	Definition
<i>domainHome</i>	Specifies the location for the Weblogic Server OR Cell Path for WebSphere. This parameter is mandatory for WebSphere. When Offline, a value is mandatory; when online, optional.

16.8.1.3 Example

```
displaySSOSessionType(domainHome="/oracle/product/OAM/domains/oam_domain")
```

16.8.2 configSSOSessionType

Online and offline command that allows you to configure session management as COOKIE-BASED or DEFAULT.

Configure session management for Access Manager.

Syntax

```
configSSOSessionType(type="<ssoSessionType>",
  cookieDomain="<cookieDomain>", domainHome="<domainHome>")
```

Argument	Definition
<i>type</i>	Specifies the type of session store. Accepted values are COOKIE_BASED or DEFAULT.
<i>cookieDomain</i>	Specifies the value of the SSO Session Timeout cookie domain.
<i>domainHome</i>	Specifies the location for the Weblogic Server OR Cell Path for WebSphere. This parameter is mandatory for WebSphere. When Offline, a value is mandatory; when online, optional.

Examples

```
configSSOSessionType(type="COOKIE_BASED", cookieDomain=".example.com")
```

```
configSSOSessionType(type="COOKIE_BASED", cookieDomain=".example.com",
  domainHome="domainHome1")
```

```
configSSOSessionType(type="Default", cookieDomain=".example.com")
```

16.8.2.1 Description

Configure session management for Access Manager.

16.8.2.2 Syntax

```
configSSOSessionType(type="<ssoSessionType>",
  cookieDomain="<cookieDomain>", domainHome="<domainHome>")
```

Argument	Definition
<i>type</i>	Specifies the type of session store. Accepted values are COOKIE_BASED or DEFAULT.
<i>cookieDomain</i>	Specifies the value of the SSO Session Timeout cookie domain.
<i>domainHome</i>	Specifies the location for the Weblogic Server OR Cell Path for WebSphere. This parameter is mandatory for WebSphere. When Offline, a value is mandatory; when online, optional.

16.8.2.3 Examples

```
configSSOSessionType(type="COOKIE_BASED",cookieDomain=".example.com")
```

```
configSSOSessionType(type="COOKIE_BASED",cookieDomain=".example.com",  
domainHome="domainHome1")
```

```
configSSOSessionType(type="Default",cookieDomain=".example.com")
```

Part V

Implementing Multi-Data Centers

Oracle Access Management allows for distribution of identical copies of directory service data across more than one data center. Administrators implement and manage Multi-Data Center environments.

These multiple data centers (referred to as multi-data centers) provide a scalable deployment model to support access management requirements for millions of users. This section contains the following chapters:

- [Understanding Multi-Data Centers](#)
- [Configuring Multi-Data Centers](#)
- [Synchronizing Data In A Multi-Data Center](#)
- [Setting Up the Multi-Data Center: A Sequence](#)

Understanding Multi-Data Centers

Oracle Access Manager allows for distribution of identical copies of directory service data across more than one data center. These multiple data centers (referred to as *multi-data centers*) provide a scalable deployment model to support access management requirements for millions of users.

The Access Manager Multi-Data Center (MDC) topology scales horizontally - within a single data center by clustering multiple nodes, or across multiple data centers. This model provides for load balancing as well as failover capabilities in the case that one of the nodes or data centers goes down. This chapter contains introductory details.

- [Introducing the Multi-Data Center](#)
- [Multi-Data Center Deployments](#)
- [Active-Active Multi-Data Center Topology Deployment](#)
- [Load Balancing Between Access Management Components](#)
- [Understanding Time Outs and Session Syncs](#)
- [Replicating a Multi-Data Center Environment](#)
- [Multi-Data Center Recommendations](#)

17.1 Introducing the Multi-Data Center

Large organizations using Access Manager 11g typically deploy their applications across multi-data centers to distribute load as well as address disaster recovery. Deploying Access Manager in multi-data centers allows for the transfer of user session details transparently after configuration of single sign-on (SSO) between them.

The scope of a data center comprises protected applications, WebGate agents, Access Manager servers and other infrastructure entities including identity stores and databases.

Note:

Access Manager 11g supports scenarios where applications are distributed across two or more data centers.

The Multi-Data Center approach supported by Access Manager is a Master-Clone deployment in which the first data center is specified as the Master and one or more Clone data centers mirror it. (Master and Clone data centers can also be referred to as Supplier and Consumer data centers.) A Master Data Center is duplicated using Test-to-Production (T2P) tools to create one or more cloned Data Centers. See *Administering Oracle Fusion Middleware* for information on T2P.

During setup of the Multi-Data Center, session adoption policies are configured to determine where a request would be sent if the Master Data Center is down. Following the setup, a manner of replicating data from the Master to the Clone(s) will be designated. This can be done using the Automated Policy Sync (APS) Replication Service or it can be done manually. See [Configuring Multi-Data Centers](#) and [Synchronizing Data In A Multi-Data Center](#) for details on the setup and synchronization process.

A data center may include applications, data stores, load balancers and the like. Each data center includes a full Access Manager installation. The WebLogic Server domain in which the instance of Access Manager is installed will not span data centers. Additionally, data centers maintain user to data center affinity. [Figure 17-1](#) illustrates the Multi-Data Center system architecture.

Figure 17-1 Multi-Data Center System Architecture

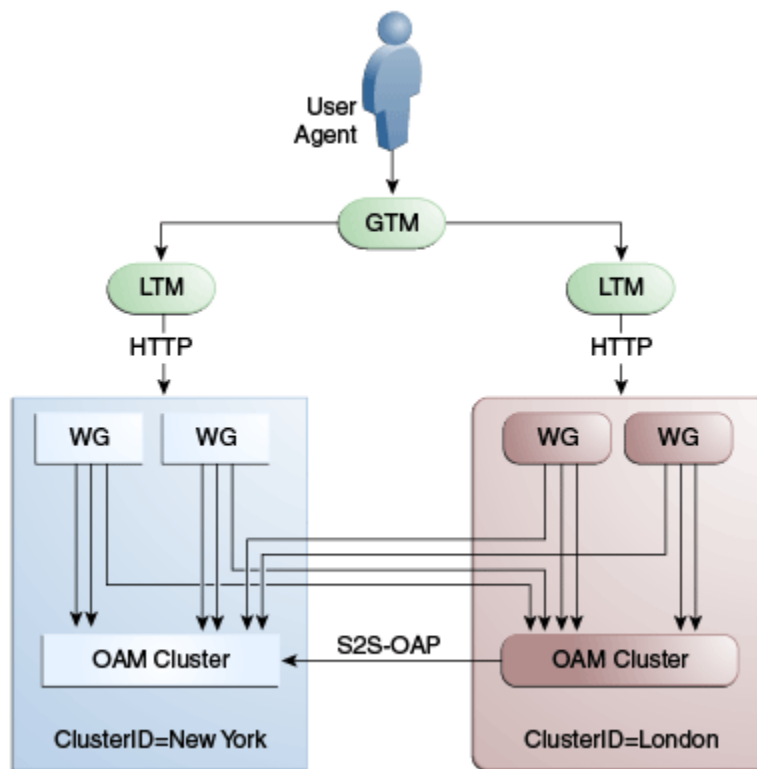

Note:

Global load balancers are configured to route HTTP traffic to the geographically closest data center. No load balancers are used to manage Oracle Access Protocol traffic.

All applications are protected by WebGate agents configured against Access Manager clusters in the respective local data centers. Every WebGate has a primary server and one or more secondary servers; WebGate agents in each data center have Access Manager server nodes from the same data center in the primary list and nodes from other data centers in the secondary list. Thus, it is possible for a user request to be routed to a different data center when:

- A local data center goes down.

- There is a load spike causing redistribution of traffic.
- Certain applications are deployed in only one data center.
- WebGates are configured to load balance within one data center but failover across data centers.

The following sections contain more information on how the Multi-Data Center solution works:

- [Understanding Cookies for Multi-Data Center](#)
- [Session Adoption During Authorization](#)
- [Session Indexing](#)
- [Supported Multi-Data Center Topologies](#)

17.1.1 Understanding Cookies for Multi-Data Center

SSO cookies (OAM_ID, OAMAuthn, and OAM_GITO) are enhanced and used by the Multi-Data Centers.

This section describes the following topics:

- [OAM_ID Cookie](#)
- [OAMAuthn / ObSSO WebGate Cookies](#)
- [OAM_GITO \(Global Inactivity Time Out\) Cookie](#)

17.1.1.1 OAM_ID Cookie

The OAM_ID cookie is the SSO cookie for Access Manager and holds the attributes required to enable the MDC behavior across all data centers.

If a subsequent request from a user in the same SSO session is routed to a different data center in the MDC topology, session adoption is triggered per the configured session adoption policies. 'Session adoption' refers to the action of a data center creating a local user session based on the submission of a valid authentication cookie (OAM_ID) that indicates a session for the user exists in another other data center in the topology. (It may or may not involve re-authentication of the user.)

When a user session is created in a data center, the OAM_ID cookie will be augmented or updated with the following:

- a `clusterid` of the data center
- a `sessionid`
- the `latest_visited_clusterid`

In MDC deployments, OAM_ID is a host-scoped cookie. Its domain parameter is set to a virtual host name which is a singleton across data centers and is mapped by the global load balancer to the Access Manager servers in the Access Manager data center based on the load balancer level user traffic routing rules (for example, based on geographical affinity). The OAM_ID cookie is not accessible to applications other than the Access Manager servers.

17.1.1.2 OAMAuthn / ObSSO WebGate Cookies

OAMAuthn is the WebGate cookie for 11g and ObSSO is the WebGate cookie for 10g. On successful authentication and authorization, a user will be granted access to a protected resource. At that point, the browser will have a valid WebGate cookie with the `clusterid:sessionid` of the authenticating Data Center.

If authentication followed by authorization spans across multiple Data Centers, the Data Center authorizing the user request will trigger session adoption by retrieving the session's originating `clusterid` from the WebGate cookie. (WebGates need to have the same host name in each data center due to host scoping of the WebGate cookies.) After adopting the session, a new session will be created in the current Data Center with the synced session details.

Note:

The WebGate cookie cannot be updated during authorization hence the newly created `sessionid` cannot be persisted for future authorization references. In this case, the remote `sessionid` and the local `sessionids` are linked through `session indexing`. During a subsequent authorization call to a Data Center, a new session will be created when:

- MDC is enabled.
- A session matching the `sessionid` in the WebGate cookie is not present in the local Data Center.
- There is no session with a Session Index that matches the `sessionid` in the WebGate cookie.
- A valid session exists in the remote Data Center (based on the MDC SessionSync Policy).

In these instances, a new session is created in the local Data Center with a Session Index that refers to the `sessionid` in the WebGate cookie.

17.1.1.3 OAM_GITO (Global Inactivity Time Out) Cookie

OAM_GITO is a domain cookie set as an authorization response.

The session details of the authentication process will be recorded in the OAM_ID cookie. If the authorization hops to a different Data Center, session adoption will occur by creating a new session in the Data Center servicing the authorization request and setting the session index of the new session as the incoming `sessionid`. Since subsequent authentication requests will only be aware of the `clusterid:sessionid` mapping available in the OAM_ID cookie, a session hop to a different Data Center for authorization will go unnoticed during the authentication request. To address this gap, an OAM_GITO cookie (which also facilitates timeout tracking across WebGate agents) is introduced.

During authorization, the OAM_GITO cookie is set as a domain cookie. For subsequent authentication requests, the contents of the OAM_GITO cookie will be read to determine the latest session information and the inactivity/idle time out values. The OAM_GITO cookie contains the following data.

- Data Center Identifier

- Session Identifier
- User Identifier
- Last Access Time
- Token Creation Time

Note:

For the OAM_GITO cookie, all WebGates and Access Manager servers should share a common domain hierarchy. For example, if the server domain is `.us.example.com` then all WebGates must have (at least) `.example.com` as a common domain hierarchy; this enables the OAM_GITO cookie to be set with the `.example.com` domain.

17.1.2 Session Adoption During Authorization

Multi-Data Center session adoption is supported during the authorization flow. After successful authentication, the OAMAuthn cookie will be augmented with the cluster ID details of the Data Center where authentication has taken place.

During authorization, if the request is routed to a different Data Center, Access Manager runtime checks to determine whether it is a Multi-Data Center scenario by looking for a valid remote session. If one is located, the Multi-Data Center session adoption process is triggered per the session adoption policy.

The session adoption policy can be configured so that the clone Access Manager cluster would make a back-end request for session details from the master Access Manager cluster using the Oracle Access Protocol (OAP). The session adoption policy can also be configured to invalidate the previous session so the user has a session only in one data center at a given time. Following the session adoption process, a new session will be created in the Data Center servicing the authorization request. See [Multi-Data Center Deployments](#).

Note:

Since OAMAuthn cookie updates are not supported during authorization, the newly created session's session index will be set to that of the incoming session ID. See [Session Indexing](#).

17.1.3 Session Indexing

A new session with a Session Index is created in the local data center during an authorization call to a data center. The Session Index refers to the session identifier in the OAMAuth cookie.

This will occur if all of the following conditions are met:

- Session matching Session ID in the OAMAuth cookie is not present in the local Data Center.
- MDC is enabled.
- No session with Session Index matching Session ID in the OAMAuth cookie.

- Valid Session exists in the remote Data Center based on the MDC SessionSync Policy.

17.1.4 Supported Multi-Data Center Topologies

Access Manager supports three Multi-Data Center topologies: Active-Active, Active-Passive, and Active-Standby modes.

The following sections contain details on these modes.

- [The MDC Active-Active Mode](#)
- [The MDC Active-Passive Mode](#)
- [The MDC Active-Hot Standby Mode](#)

17.1.4.1 The MDC Active-Active Mode

An Active-Active topology is when Master and Clone data centers are exact replicas and active at the same time.

They cater to different sets of users based on defined criteria; geography, for example. A load balancer routes traffic to the appropriate Data Center. [Figure 17-2](#) illustrates a Multi-Data Center set up in Active-Active mode during normal operations.

Figure 17-2 Active-Active Deployment Mode

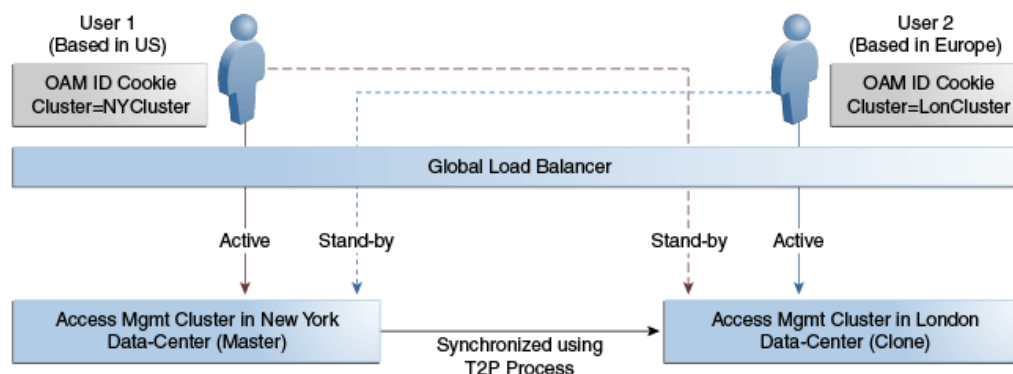

In [Figure 17-2](#), the New York Data Center is designated as the Master and all policy and configuration changes are restricted to it. The London Data Center is designated as a Clone and uses T2P tooling and utilities to periodically synchronize data with the New York Data Center. The global load balancer is configured to route users in different geographical locations (US and Europe) to the appropriate data centers (New York or London) based on proximity to the data center (as opposed to proximity of the application being accessed). For example, all requests from US-based User 1 will be routed to the New York Data Center (NYDC) and all requests from Europe-based User 2 will be routed to the London Data Center (LDC).

Note:

The Access Manager clusters in [Figure 17-2](#) are independent and not part of the same Oracle WebLogic domain. WebLogic domains are not recommended to span across data centers.

In this example, if NYDC was overloaded with requests, the global load balancer would start routing User 1 requests to the clone Access Manager cluster in LDC. The clone Access Manager cluster can tell (from the user's OAM_ID cookie) that there is a valid session in the master cluster and would therefore create a new session without prompting for authentication or re-authentication. Further, the session adoption policy can be configured such that the clone Access Manager cluster would make a back-end request for session details from the master Access Manager cluster using the Oracle Access Protocol (OAP). The session adoption policy can also be configured to invalidate the remote session (the session in NYDC) so the user has a session only in one data center at a given time.

Figure 17-3 illustrates how a user might be rerouted if the Master cluster is overloaded or down. If the Master Access Manager cluster were to go completely down, the clone Access Manager cluster would try to obtain the session details of User 1 but since the latter would be completely inaccessible, User 1 would be forced to re-authenticate and establish a new session in the clone Access Manager cluster. In this case, any information stored in the previous session is lost.

Figure 17-3 Active-Active Mode Failover

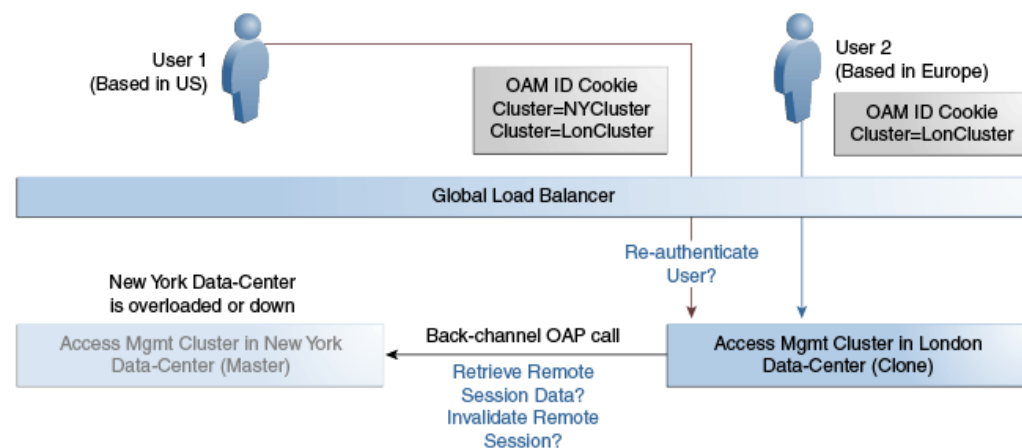

Note:

An Active-Active topology with agent failover is when an agent has Access Manager servers in one Data Center configured as primary and Access Manager servers in the other Data Centers configured as secondary to aid failover scenarios.

More details on an Active-Active topology can be found in [Active-Active Multi-Data Center Topology Deployment](#)

17.1.4.2 The MDC Active-Passive Mode

An Active-Passive topology is when the primary Data Center is operable but the clone Data Center is not. In this topology, the clone can be brought up within a reasonable time in cases when the primary Data Center fails. Thus, in the Active-Passive Mode one of the data centers is passive and services are not started.

In this use case, the data center does not have to be brought up immediately but within a reasonable amount of time in cases when the primary data center fails. There is no need to do an MDC setup although policy data will be kept in sync.

17.1.4.3 The MDC Active-Hot Standby Mode

Active-Hot Standby is when one of the Data Centers is in *hot standby* mode. In this case, traffic will not be routed to the Hot Standby Data Center unless the Active Data Center goes down.

In this use case, you do not need additional data centers for traffic on a daily basis but only keep one ready. Follow the Active-Active Mode steps to deploy in Active-Hot Standby Mode but do not route traffic to the center defined as Hot Standby. The Hot Standby center will continue to sync data but will only be used when traffic is directed there by the load balancer or by an administrator.

17.2 Multi-Data Center Deployments

In a Multi-Data Center deployment, each data center will include a full Access Manager installation; WebLogic Server domains will not span the Data Centers.

Global load balancers will maintain user to Data Center affinity although a user request may be routed to a different Data Center when:

- The data center goes down.
- A load spike causes redistribution of traffic.
- Each Data Center is not a mirror of the other. For example, certain applications may only be deployed in a single Data Center.
- WebGates are configured to load balance within the Data Center and failover across Data Centers.

Figure 17-4 illustrates a basic Multi-Data Center deployment.

Figure 17-4 Multi-Data Center Deployment

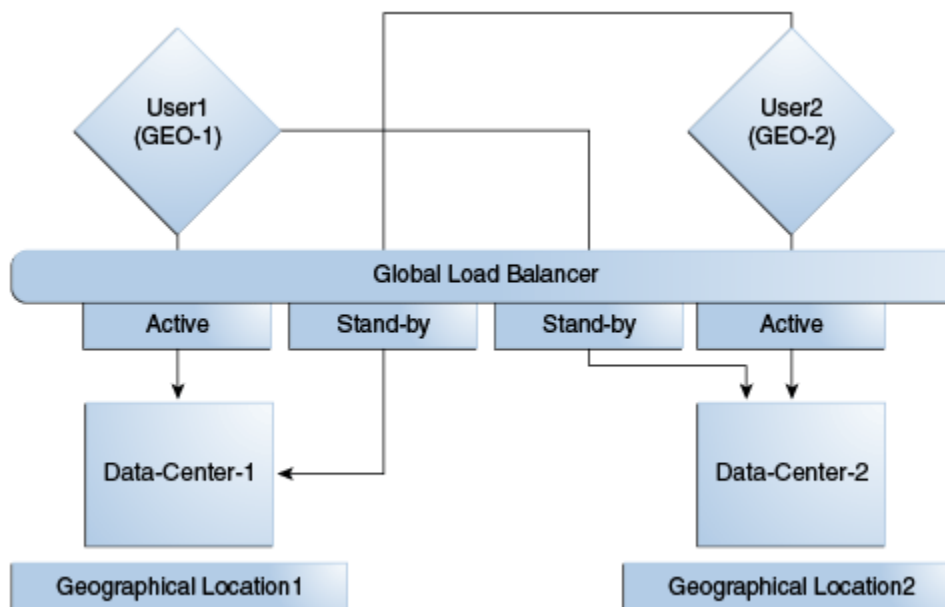

The following sections describe several deployment scenarios.

- [Session Adoption Without Re-authentication, Session Invalidation or Session Data Retrieval](#)
- [Session Adoption Without Re-authentication But With Session Invalidation and Session Data Retrieval](#)
- [Session Adoption Without Re-authentication and Session Invalidation But With On-demand Session Data Retrieval](#)
- [Authentication and Authorization Requests Served By Different Data Centers](#)
- [Logout and Session Invalidation](#)
- [Stretch Cluster Deployments](#)

Note:

The OAP connection used for back channel communication does not support load balancing or failover so a load balancer needs to be used.

17.2.1 Session Adoption Without Re-authentication, Session Invalidation or Session Data Retrieval

The following scenario illustrates the flow when the Session Adoption Policy is configured without re-authentication, remote session invalidation and remote session data retrieval.

It is assumed the user has affinity with DC1.

1. User is authenticated by DC1.
On successful authentication, the OAM_ID cookie is augmented with a unique data center identifier referencing DC1 and the user can access applications protected by Access Manager in DC1.
2. Upon accessing an application deployed in DC2, the user is routed to DC2 by a global load balancer.
3. Access Manager in DC2 is presented with the augmented OAM_ID cookie issued by DC1.
On successful validation, Access Manager in DC2 knows that this user has been routed from the remote DC1.
4. Access Manager in DC2 looks up the Session Adoption Policy.
The Session Adoption Policy is configured without reauthentication, remote session invalidation or remote session data retrieval.
5. Access Manager in DC2 creates a local user session using the information present in the DC1 OAM_ID cookie (lifetime, user) and re-initializes the static session information (\$user responses).
6. Access Manager in DC2 updates the OAM_ID cookie with its data center identifier.

Data center chaining is also recorded in the OAM_ID cookie.

7. User then accesses an application protected by Access Manager in DC1 and is routed back to DC1 by the global load balancer.
8. Access Manager in DC1 is presented with the OAM_ID cookie issued by itself and updated by DC2.
On successful validation, Access Manager in DC1 knows that this user has sessions in both DC1 and DC2.
9. Access Manager in DC1 attempts to locate the session referenced in the OAM_ID cookie.
 - If found, the session in DC1 is updated.
 - If not found, Access Manager in DC1 looks up the Session Adoption Policy (also) configured without reauthentication, remote session invalidation and remote session data retrieval.
10. Access Manager in DC1 updates the OAM_ID cookie with its data center identifier and records data center chaining as previously in DC2.

17.2.2 Session Adoption Without Re-authentication But With Session Invalidation and Session Data Retrieval

The following scenario illustrates the flow when the Session Adoption Policy is configured without re-authentication but with remote session invalidation and remote session data retrieval.

It is assumed the user has affinity with DC1.

1. User is authenticated by DC1.
On successful authentication, the OAM_ID cookie is augmented with a unique data center identifier referencing DC1.
2. Upon accessing an application deployed in DC2, the user is routed to DC2 by a global load balancer.
3. Access Manager in DC2 is presented with the augmented OAM_ID cookie issued by DC1.
On successful validation, Access Manager in DC2 knows that this user has been routed from the remote DC1.
4. Access Manager in DC2 looks up the Session Adoption Policy.
The Session Adoption Policy is configured without reauthentication but with remote session invalidation and remote session data retrieval.
5. Access Manager in DC2 makes a back-channel (OAP) call (containing the session identifier) to Access Manager in DC1 to retrieve session data.
The session on DC1 is terminated following data retrieval. If this step fails due to a bad session reference, a local session is created. See [Session Adoption Without Re-authentication, Session Invalidation or Session Data Retrieval](#).
6. Access Manager in DC2 creates a local user session using the information present in the OAM_ID cookie (lifetime, user) and re-initializes the static session information (\$user responses).

7. Access Manager in DC2 rewrites the OAM_ID cookie with its own data center identifier.
8. The user then accesses an application protected by Access Manager in DC1 and is routed to DC1 by the global load balancer.
9. Access Manager in DC1 is presented with the OAM_ID cookie issued by DC2.
On successful validation, Access Manager in DC1 knows that this user has sessions in DC2.
10. Access Manager in DC1 makes a back-channel (OAP) call (containing the session identifier) to Access Manager in DC2 to retrieve session data.
If the session is found, a session is created using the retrieved data. If it is not found, the OAM Server in DC1 creates a new session. The session on DC2 is terminated following data retrieval.

17.2.3 Session Adoption Without Re-authentication and Session Invalidation But With On-demand Session Data Retrieval

Multi-Data Center supports session adoption without re-authentication except that the non-local session are not terminated and the local session is created using session data retrieved from the remote DC.

Note that the OAM_ID cookie is updated to include an attribute that indicates which data center is currently being accessed.

17.2.4 Authentication and Authorization Requests Served By Different Data Centers

Consider a scenario where an authentication request is served by the New York Data Center (NYDC) but the authorization request is presented to the London Data Center (LDC) because of user affinity.

If Remote Session Termination is enabled, the scenario requires a combination of the OAM_ID cookie, the OamAuthn/ObSSO authorization cookie and the GITO cookie to perform the seamless Multi-Data Center operations. This flow (and [Figure 17-5](#) following it) illustrates this. It is assumed that the user has affinity with NYDC.

1. Upon accessing APP1, a user is authenticated by NYDC.
On successful authentication, the OAM_ID cookie is augmented with a unique data center identifier referencing NYDC. The subsequent authorization call will be served by the primary server for the accessed resource, NYDC. Authorization generates the authorization cookie with the NYDC identifier (cluster-id) in it and the user is granted access to the APP1.
2. User attempts to access APP2 in LDC.
3. The WebGate for APP2 finds no valid session in LDC and initiates authentication.
Due to user affinity, the authentication request is routed to NYDC where seamless authentication occurs. The OamAuthn cookie contents are generated and shared with the APP2 WebGate.
4. The APP2 WebGate forwards the subsequent authorization request to APP2's primary server, LDC with the authorization cookie previously generated.
During authorization, LDC will determine that this is a Multi-Data Center scenario and a valid session is present in NYDC. In this case, authorization is

accomplished by syncing the remote session as per the configured session adoption policies.

5. A new session is created in LDC during authorization and the incoming session id is set as the new session's index.

Subsequent authorization calls are honored as long as the session search by index returns a valid session in LDC. Each authorization will update the GITO cookie with the cluster-id, session-id and access time. The GITO cookie will be re-written as an authorization response each time.

If a subsequent authentication request from the same user hits NYDC, it will use the information in the OAM_ID and GITO cookies to determine which Data Center has the most current session for the user. The Multi-Data Center flows are triggered seamlessly based on the configured Session Adoption policies.

Figure 17-5 Requests Served By Different Data Centers

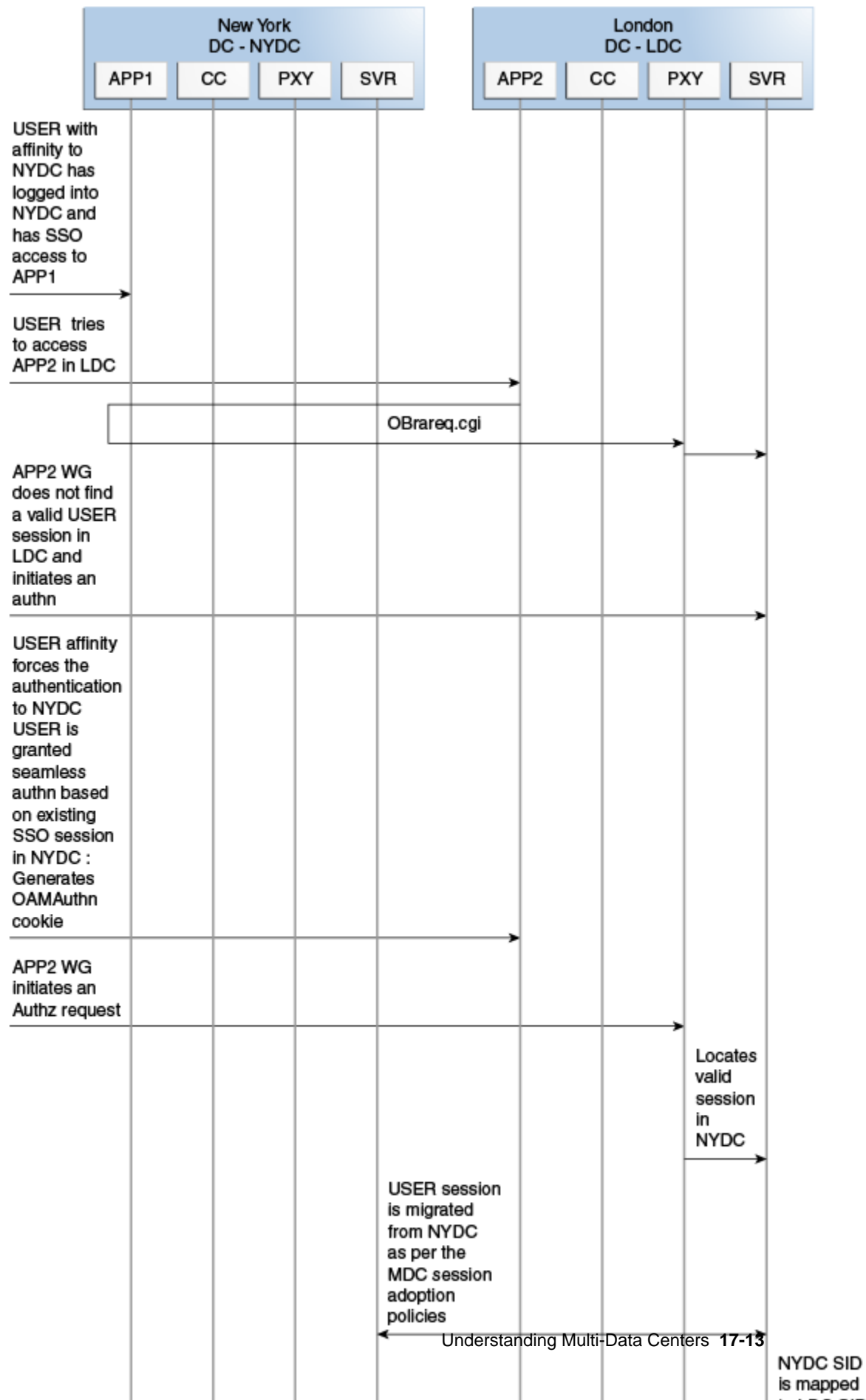

17.2.5 Logout and Session Invalidation

In Multi-Data Center scenarios, logout ensures that all server side sessions across Data Centers and all authentication cookies are cleared out. For session invalidation, termination of a session artifact over the back-channel will not remove the session cookie and state information maintained in the WebGates.

However, the lack of a server session will result in an Authorization failure which will result in re-authentication. In the case of no session invalidation, the logout clears all server side sessions that are part of the current SSO session across Data Centers. This flow (and [Figure 17-6](#) following it) illustrates logout. It is assumed that the user has affinity with NYDC.

1. User with affinity to NYDC gets access to APP1 after successful authentication with NYDC.
2. User attempts to access APP2.
At this point there is a user session in NYDC as well as LDC as part of SSO.
3. User logs out from APP1.
Due to affinity, the logout request will reach NYDC.
4. The NYDC server terminates the user's SSO session and logs out from all the SSO partners.
5. The NYDC server sends an OAP terminate session request to all relevant Data Centers associated with the SSO session - including LDC.

This results in clearing all user sessions associated with the SSO across Data Centers.

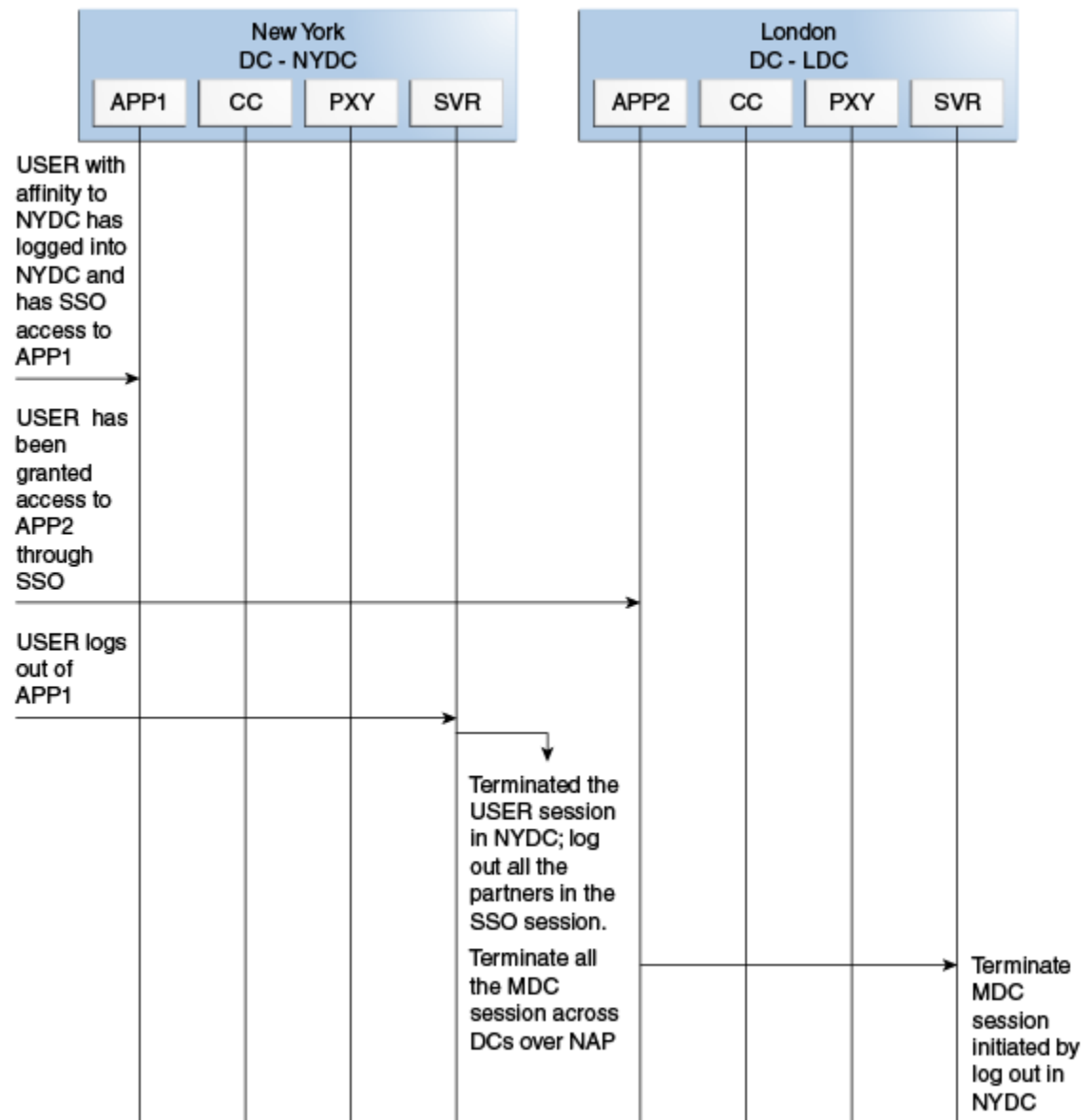
Figure 17-6 Logout and Session Invalidation

17.2.6 Stretch Cluster Deployments

For data centers that are geographically very close and have a guaranteed latency of less than 5 milliseconds, customers can choose a Stretch Cluster deployment.

In this case, unlike the traditional Multi Data Center deployment described in the preceding sections, a single OAM cluster is stretched across multiple data centers; there are some OAM nodes in one Data Center and the remaining nodes in another Data Center. Though the deployment is spread across two data centers, Access Manager treats this as a single cluster. The policy database would reside in one of the Data Centers. The following limitations apply to a Stretch Cluster Deployment.

- Access Manager depends on the underlying WebLogic and Coherence layers to keep the nodes in sync. The latency between Data Centers must be less than 5 milliseconds at all times. Any spike in the latency may cause instability and unpredictable behavior.

- The cross data center chatter at runtime in a Stretch Cluster deployment is relatively more than that in the traditional Multi Data Center deployment. In case of the latter, the runtime communication between Data Centers is restricted to use-cases where a session has to be adopted across Data Centers.
- Since it is a single cluster across Data Centers, it does not offer the same level of reliability/availability as a traditional multi data center deployment. The policy database can become a single point of failure. In a traditional Multi Data Center deployment, each Data Center is self-sufficient and operates independent of the other Data Center which provides far better reliability.

Figure 17-7 illustrates a Stretch Cluster deployment while Figure 17-8 below it illustrates a traditional MDC deployment. Oracle does recommend a traditional multi data center deployment over a Stretch Cluster deployment.

Figure 17-7 Stretch Cluster Deployment

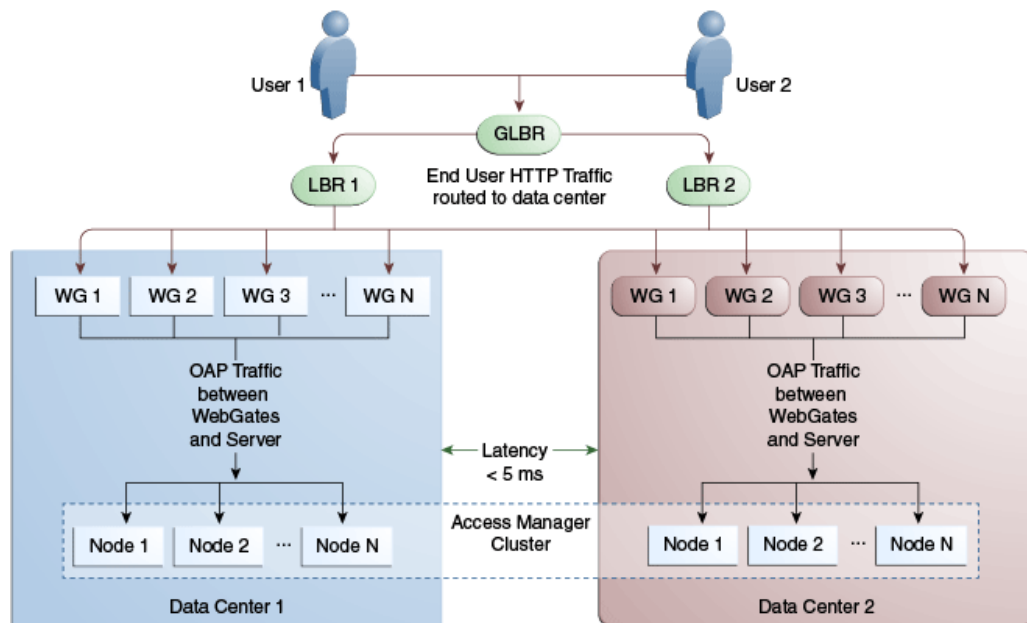
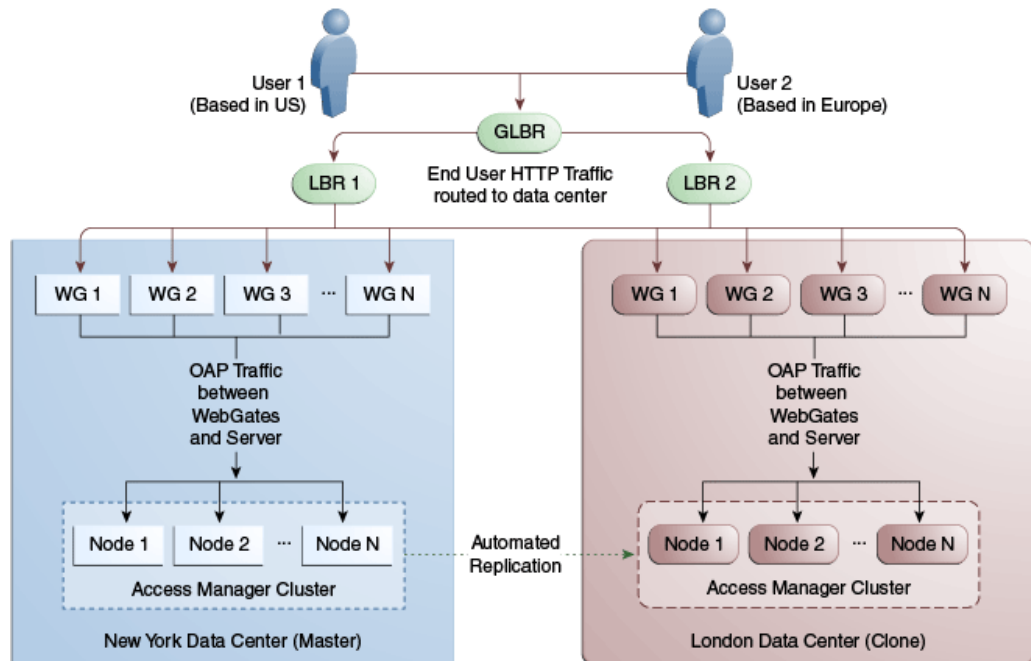

Figure 17-8 Traditional MDC Deployment

See Also: [Supported Multi-Data Center Topologies](#)

17.3 Active-Active Multi-Data Center Topology Deployment

An Active-Active topology is when Master and Clone Data Centers are exact replicas of each other (including applications, data stores and the like).

They are active at the same time and cater to different sets of users based on defined criteria - geography, for example. A load balancer routes traffic to the appropriate Data Center. Identical Access Manager clusters are deployed in both locales with New York designated as the Master and London as the Clone.

Note:

An Active-Active topology with agent failover is when an agent has Access Manager servers in one Data Center configured as primary and Access Manager servers in the other Data Centers configured as secondary to aid failover scenarios.

[Figure 17-9](#) illustrates the topology for a Multi-Data Center deployment in Active-Active mode. The New York Data Center is designated as the Master and all policy and configuration changes are restricted to it. The London Data Center is designated as a Clone and uses T2P tooling and utilities to periodically synchronize data with the New York Data Center. The global load balancer is configured to route users in different geographical locations (US and Europe) to the appropriate data centers (New York or Europe) based on proximity to the data center (as opposed to proximity of the application being accessed). For example, all requests from US-based User 1 will be routed to the New York Data Center (NYDC) and all requests from Europe-based User 2 will be routed to the London Data Center (LDC).

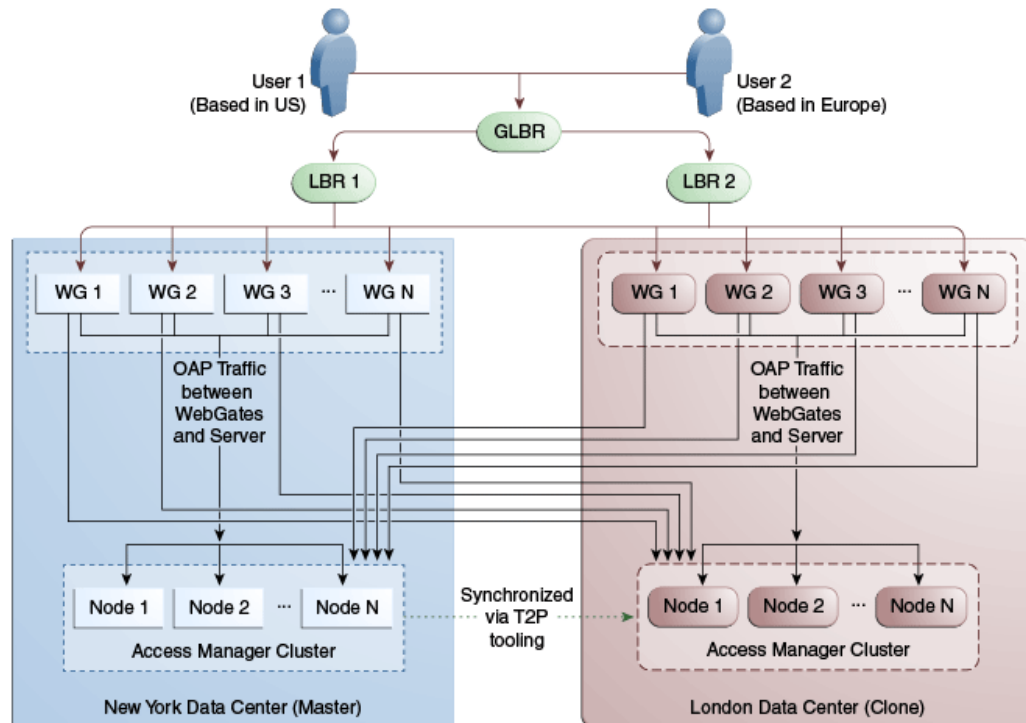
Figure 17-9 Active-Active Topology

The Global Load Balancer is configured for session stickiness so once a user has been assigned to a particular data center, all subsequent requests from that user would be routed to the same data center. In this example, User 1 will always be routed to the New York Data Center and User 2 to the London Data Center.

User requests in the respective data centers are intercepted by different WebGates depending on the application being accessed. Each WebGate has the various nodes of the Access Manager cluster within the same data center configured as its primary servers. In this case, the WebGates load balance and failover the local data center.

Note:

Administrators have the flexibility to configure the primary servers for every WebGate in different orders based on load characteristics. Running monitoring scripts in each data center will detect if any of the Access Manager components – the WebGates or the servers – are unresponsive so administrators can reconfigure the load balancers to direct user traffic to a different data center.

Any number of Clone data centers can be configured to distribute the load across the globe. The only condition is that all Clone data centers are synchronized from a single Master using T2P. [Figure 17-10](#) below depicts an Active-Active Multi-Data Center deployment across five data centers.

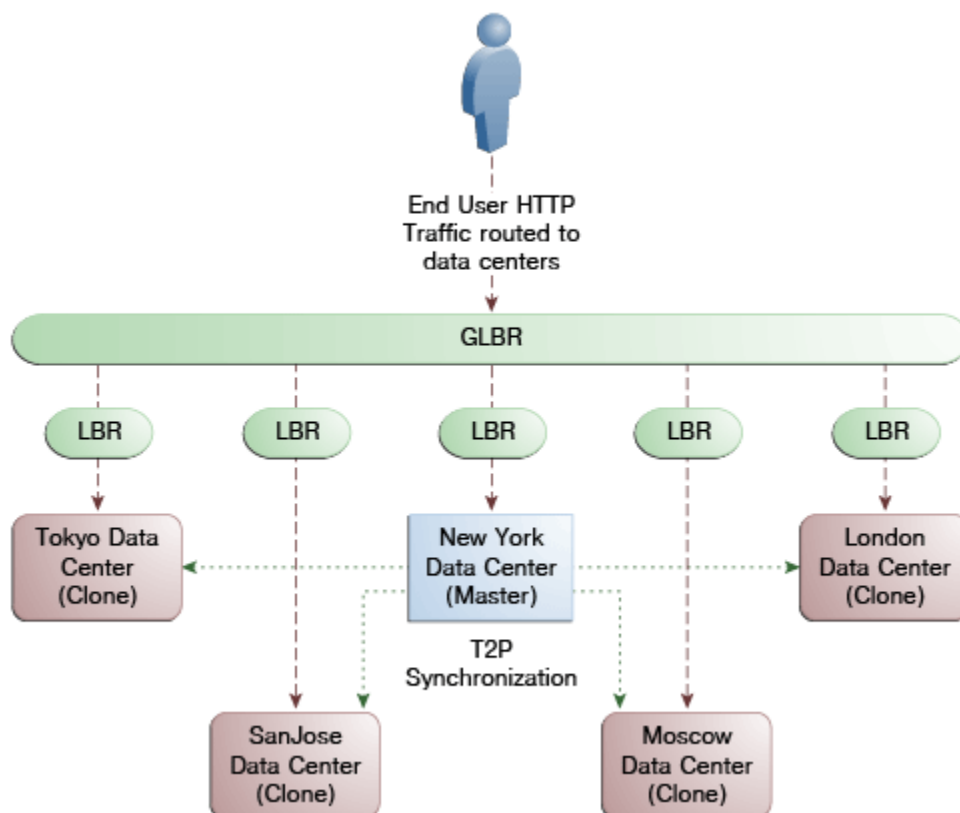
Figure 17-10 Active-Active Topology Across Multiple Data Centers

17.4 Load Balancing Between Access Management Components

The topology described earlier shows global and local load balancers for routing the end user HTTP traffic to various data centers. Customers can choose to deploy load balancers between the access manager components to simplify the configuration of the access manager components by using virtual host names.

For example, instead of configuring the primary servers in each WebGate in the NYDC as `ssonode1.ny.acme.com`, `ssonode2.ny.acme.com` and so on, they can all point to a single virtual hostname like `sso.ny.acme.com` and the load balancer will resolve the DNS to direct them to various nodes of the cluster. However, while introducing a load balancer between Access Manager components, there are a few constraining requirements to keep in mind.

- OAP connections are persistent and need to be kept open for a configurable duration even while idle.
- The WebGates need to be configured to recycle their connections proactively prior to the Load Balancer terminating the connections, unless the Load Balancer is capable of sending TCP resets to both the Webgate and the server ensuring clean connection cleanup.
- The Load Balancer should distribute the OAP connection uniformly across the active Access Manager Servers for each WebGate (distributing the OAP connections according the source IP), otherwise a load imbalance may occur.

Figure 17-11 illustrates a variation of the deployment topology with local load balancers (LBR 3 and LBR 4) front ending the clusters in each data center. These local load balancers can be Oracle HTTP Servers (OHS) with `mod_wl_ohs`. The OAP traffic

still flows between the WebGates and the Access Manager clusters within the data center but the load balancers perform the DNS routing to facilitate the use of virtual host names.

Note:

For information on monitoring Access Manager server health with a load balancer in use, see [Monitoring the Health of an Access Manager Server](#).

Figure 17-11 Load Balancing Access Manager Components

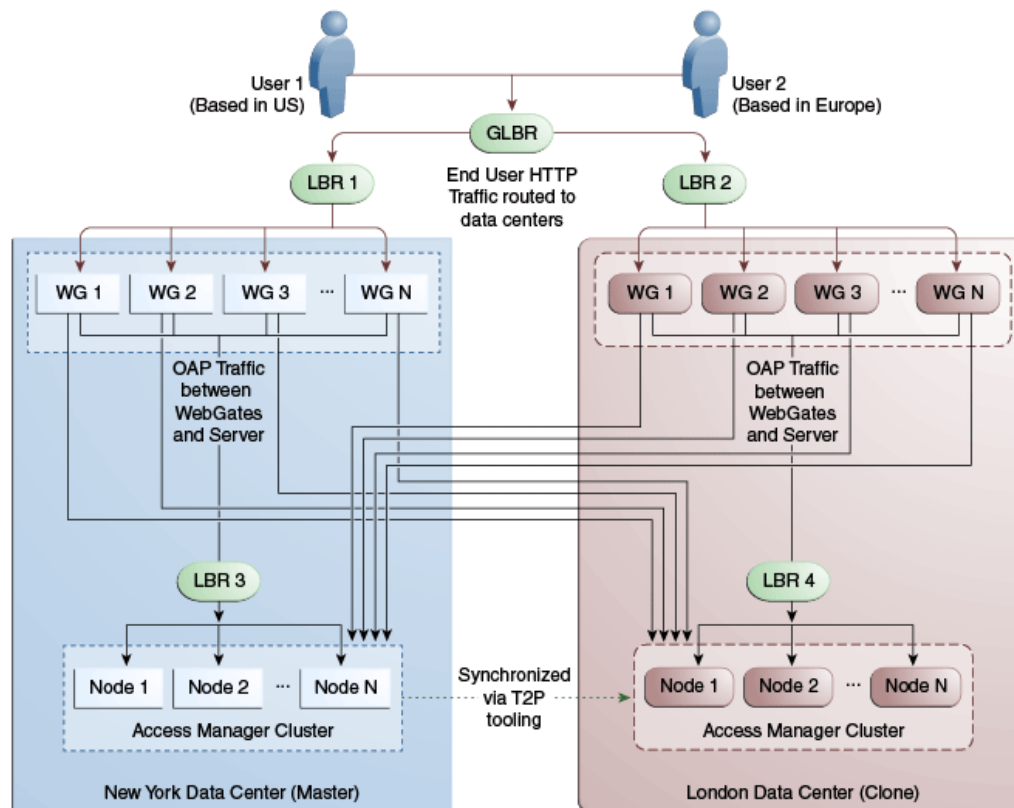
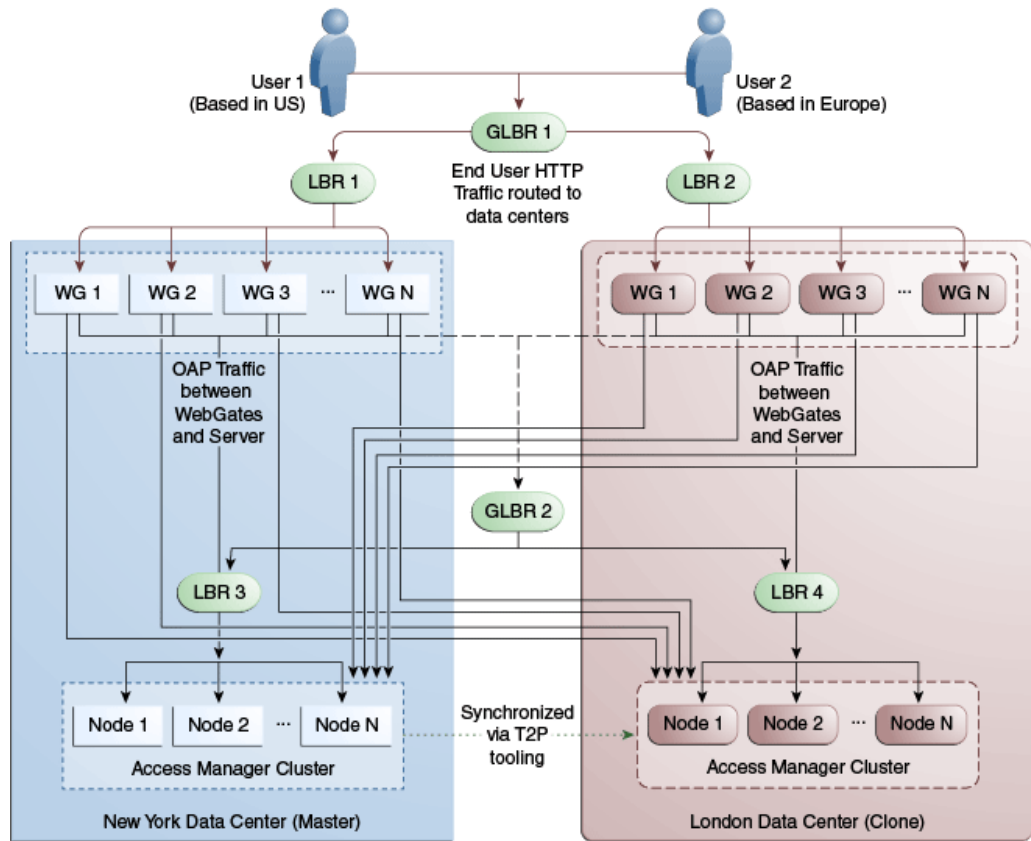

Figure 17-12 illustrates a second variation of the deployment topology with the introduction of a global load balancer (GLBR2) to front end local load balancers (LBR3 and LBR4). In this case, the host names can be virtualized not just within the data center but across the data centers. The WebGates in each data center would be configured to load balance locally but fail over remotely. One key benefit of this topology is that it guarantees high availability at all layers of the stack. Even if the entire Access Manager cluster in a data center were to go down, the WebGates in that data center would fail over to the Access Manager cluster in the other data center.

Figure 17-12 Global Load Balancer Front Ends Local Load Balancer

17.5 Understanding Time Outs and Session Syncs

The following sections contain information on how the Multi-Data Center deals with session time outs and syncs.

- [Maximum Session Constraints](#)
- [Multi-Data Center Policy Configurations for Idle Timeout](#)
- [Expiring Multi-Data Center Sessions](#)
- [Session Synchronization and Multi-Data Center Fail Over](#)

17.5.1 Maximum Session Constraints

Credential Collector user affinity ensures that maximum session constraints per user are honored.

There is no Multi-Data Center session store to validate allowed maximum sessions per user.

17.5.2 Multi-Data Center Policy Configurations for Idle Timeout

The OAM_ID and OAM_GITO cookies are used to calculate and enforce idle (inactivity) timeouts. The OAM_GITO cookie, though, can be set only if there is a common sub-domain across WebGates. Thus, Multi-Data Center policies should be configured based on whether or not the OAM_GITO cookie is set.

Table 17-1 documents the policy configurations.

Table 17-1 Multi-Data Center Policy Configurations for Idle Timeout

OAM_GITO Set	Multi-Data Center Policies
Yes Idle timeout will be calculated from the latest OAM_GITO cookie	SessionMustBeAnchoredToDataCenterServicingUser=<true/false> SessionDataRetrievalOnDemand=true Reauthenticate=false SessionDataRetrievalOnDemandMax_retry_attempts=<number> SessionDataRetrievalOnDemandMax_conn_wait_time=<milliseconds> SessionContinuationOnSyncFailure=<true/false> MDCGitoCookieDomain=<sub domain>
No Idle time out will be calculated from the OAM_ID cookie because OAM_GITO is not available	SessionMustBeAnchoredToDataCenterServicingUser=false SessionDataRetrievalOnDemand=true Reauthenticate=false SessionDataRetrievalOnDemandMax_retry_attempts=<number> SessionDataRetrievalOnDemandMax_conn_wait_time=<milliseconds> SessionContinuationOnSyncFailure=<true/false> #MDCGitoCookieDomain= This setting should be commented or removed

17.5.3 Expiring Multi-Data Center Sessions

Session expiration will be managed by the Data Center with which the user has affinity.

Users have affinity to a particular Data Center based on the global traffic manager/load balancer.

17.5.4 Session Synchronization and Multi-Data Center Fail Over

When a valid session corresponding to the user's request exists in a remote data center, based on MDC session synchronization policies, the remote session attributes are migrated and synced to the data center servicing the current request. If the synchronization fails, the datacenter can still access the requested resource as the Webgate failover across data centers is supported by the MDC.

Access Manager server side sessions are created and maintained based on single sign-on (SSO) credentials. The attributes stored in the session include (but are not limited to) the user identifier, an identity store reference, subject, custom attributes, partner data, client IP address and authentication level. SSO will be granted if the server can locate a valid session corresponding to the user's request.

In a Multi-Data Center scenario, when a user request hops across Data Centers, the Data Center servicing the request should validate for a legitimate session locally and across Data Centers. If a valid session for a given request exists in a remote Data Center, the remote session needs to be migrated to the current Data Center based on the MDC session synchronization policies. (See [Multi-Data Center Deployments](#).) During this session synchronization, all session attributes from the remote session are synced to the newly created session in the Data Center servicing the current request.

The Multi-Data Center also supports WebGate failover across Data Centers. When a WebGate fails over from one Data Center to a second, the session data can not be synchronized because the first Data Center servers are down. Thus, the second Data Center will decide whether or not to proceed with the session adoption based on the setting configured for `SessionContinuationOnSyncFailure`. When true, even if the OAP communication to the remote Data Center fails, the Data Center servicing the current request can proceed to create a new session locally based on the mandatory attributes available in the cookie. This provides seamless access to the requested resource despite the synchronization failure. [Table 17-2](#) summarizes prominent session synchronization and failover scenarios. The parameters in this table are explained in greater detail in [Table 18-4](#).

Table 17-2 Session Synchronization and Failover Scenarios

MDC Deployment	MDC Policy	Validate Remote Session	Synchronized in DC Servicing User From Remote DC	Terminate Remote Session	User Challenged
Active-Active	<code>SessionMustBeAnchoredToDataCenterServicingUser=true</code> <code>SessionDataRetrievalOnDemand=true</code> <code>Reauthenticate=false</code> <code>SessionDataRetrievalOnDemandMax_retry_attempts=<number></code> <code>SessionDataRetrievalOnDemandMax_conn_wait_time=<milliseconds></code> <code>SessionContinuationOnSyncFailure= false</code> <code>MDCGitoCookieDomain=<sub domain></code>	Yes	Yes	Yes	When a valid session could not be located in a remote DC
Active-Active	<code>SessionMustBeAnchoredToDataCenterServicingUser=false</code> <code>SessionDataRetrievalOnDemand=true</code> <code>Reauthenticate=false</code> <code>SessionDataRetrievalOnDemandMax_retry_attempts=<number></code> <code>SessionDataRetrievalOnDemandMax_conn_wait_time=<milliseconds></code> <code>SessionContinuationOnSyncFailure= false</code> <code>MDCGitoCookieDomain=<sub domain></code>	Yes	Yes	No	When a valid session could not be located in a remote DC

Table 17-2 (Cont.) Session Synchronization and Failover Scenarios

MDC Deployment	MDC Policy	Validate Remote Session	Session Synchronized in DC Servicing User From Remote DC	Terminate Remote Session	User Challenged
Active-Standby	SessionMustBeAnchoredToDataCenterServicingUser=true SessionDataRetrievalOnDemand=true Reauthenticate=false SessionDataRetrievalOnDemandMax_retry_attempts=<number> SessionDataRetrievalOnDemandMax_conn_wait_time=<milliseconds> SessionContinuationOnSyncFailure= false MDCGitoCookieDomain=<sub domain>	Could not validate as the remote DC is down	No, since the remote DC is down	Could not terminate as the remote DC is down	Yes
Active-Standby	SessionMustBeAnchoredToDataCenterServicingUser=true SessionDataRetrievalOnDemand=true Reauthenticate=false SessionDataRetrievalOnDemandMax_retry_attempts=<number> SessionDataRetrievalOnDemandMax_conn_wait_time=<milliseconds> SessionContinuationOnSyncFailure= true MDCGitoCookieDomain=<sub domain>	Could not validate as the remote DC is down	No, since the remote DC is down	Could not terminate as the remote DC is down	No Provides seamless access by creating a local session from the details available in the valid cookie

17.6 Replicating a Multi-Data Center Environment

Data in the Multi-Data Center environment must be replicated from the Master (supplier) to the Clones (consumers) as part of the initial setup procedure.

Following this initial replication, the data must be synced across data centers on a regular basis. The following sections have more details.

- [Replicating Data Using the WLST](#)
- [Syncing Data Using Automated Policy Synchronization](#)

The following artifacts must be replicated and synced regularly.

- WebGate Profiles
While the WebGate profile is replicated to the Clone, the primary server list and logout URL details are updated with information about the Clone data center.
- Authentication Modules
- OAM Proxy Configurations
- Session Manager configurations
- Policy and partner data

See [Synchronizing Data In A Multi-Data Center](#) .

17.6.1 Replicating Data Using the WLST

Initial replication of data (when setting up the Multi-Data Center) must be done manually using the WLST.

Following this initial replication, WLST commands or the Automated Policy Sync Replication Service can be used to sync the already replicated data. When using the WLST, partner profiles and policies are exported from the Master Data Center and then imported to the Clone Data Center. Replication of data in a Multi-Data Center environment is a requirement and using WLST for this purpose is the minimum method for accomplishing this.

See Also:

- [About Synchronizing Data Manually in a Multi-Data Center](#)
 - [Syncing Data Using Automated Policy Synchronization](#)
-
-

17.6.2 Syncing Data Using Automated Policy Synchronization

Automated Policy Synchronization (APS, also referred to as the Replication Service) is a set of REST API used to automatically replicate data from the Master Data Center to Clone Data Centers.

It can be configured to keep Access Manager data synchronized across multiple data centers. A valid replication agreement between the data centers must be present before APS can run. See [Understanding the Multi-Data Center Synchronization](#).

Note:

APS is not used to do a complete replication from scratch. You will first need to replicate data manually using the WLST to establish a base line. APS is only designed to keep data centers in sync.

17.7 Multi-Data Center Recommendations

This section contains recommendations regarding the Multi-Data Center functionality.

- [Using a Common Domain](#)
- [Concerning the DCC and the OAM_GITO](#)

- [Using an External Load Balancer](#)
- [Honoring Maximum Sessions](#)
- [WebGate Cookie Cannot Be Refreshed During Authorization](#)

17.7.1 Using a Common Domain

It is recommended that WebGates be domain-scoped in a manner that a common domain can be inferred across all WebGates and the OAM Server Credential Collectors. This allows for WebGates to set an encrypted GITO cookie to be shared with the OAM Server.

For example, if WebGates are configured on applications.abc.com and the OAM Server Credential Collectors on server.abc.com, abc.com is the common domain used to set the GITO cookie. In scenarios where a common domain cannot be inferred, setting the GITO cookie is not practical as a given Data Center may not be aware of the latest user sessions in another Data Center. This would result in the Data Center computing session idle-timeout based on old session data and could result in re-authenticating the user even though a more active session lives elsewhere.

Note:

A similar issue occurs during server fail-over when the `SessionContinuationOnSyncFailure` property is set. The expectation is to retrieve the session from contents of the OAM_ID cookie. Since it's not possible to retrieve the actual inactivity time out value from the GITO cookie, a re-authentication could result.

When there is no common cookie domain across WebGates and OAM servers, make the following configuration changes to address idle time out issues.

- Run the `enableMultiDataCentreMode WLST` command after removing the `MDCGitoCookieDomain` property from the input properties file.
- Because a WebGate cookie cannot be refreshed during authorization, set the value of the WebGate cookie validity lower than the value of the session idle time out property. Consider a session idle time out value of 30 minutes and a WebGate cookie validity value of 15 minutes; in this case, every 15 minutes the session will be refreshed in the authenticating Data Center.

Note:

For 10G WebGates, since the token is not expired by the WebGate, the server will continue to honor a 10G WebGate cookie until the session in the base DC (authenticating DC) idles out.

17.7.2 Concerning the DCC and the OAM_GITO

The OAM_GITO cookie is not applicable when using the DCC.

Because of this:

- The `#MDCGitoCookieDomain=` setting should be commented out.

- The `SessionMustBeAnchoredToDataCenterServicingUser` parameter must be set to false.
- The WebGate cookie expiration interval should be set as documented in [Using a Common Domain](#)

17.7.3 Using an External Load Balancer

Access Manager uses the 11g SDK API to retrieve session data but this API does not support SDK based load-balancing across the configured set of primary servers. Use an external TCP based load balancer to front-end the OAP endpoints of the Data Center nodes where high performance is expected.

Note:

Failover between primary and secondary OAM servers is supported in the current release of 11g SDK APIs.

17.7.4 Honoring Maximum Sessions

A typical Multi-Data Center scenario authenticates users against the Data Center with which the user geography has an affinity. In the rare scenarios where user authentication and session creation for a given user spans across member Data Centers (bypassing geographic affinity and load spike), the maximum sessions the user has in the whole Multi-Data Center topology would not be honored.

17.7.5 WebGate Cookie Cannot Be Refreshed During Authorization

Because a WebGate cookie cannot be refreshed during authorization, set the value of the WebGate cookie validity lower than the value of the session idle time out property.

Consider a session idle time out value of 30 minutes and a WebGate cookie validity value of 15 minutes; in this case, every 15 minutes the session will be refreshed in the authenticating Data Center. Setting the WebGate cookie expiration to less than 2 minutes is the recommendation.

Note:

This will not work for 10G WebGates because the 10G WebGate token expiration is driven by the server and not the WebGate. The server will continue to honor a 10G WebGate cookie until the session in the base DC (authenticating DC) idles out. A logout will work by clearing browser cookies; the dangling server side session will continue to exist but is considered harmless.

Configuring Multi-Data Centers

The Multi-Data Center feature is disabled by default. This chapter contains details on how to enable and configure the Multi-Data Center functionality.

The following sections have details.

- [Before Setting Up a Multi-Data Center](#)
- [Primary Multi-Data Center Use Cases](#)
- [Setting Up a Multi-Data Center](#)
- [Adding A Second Clone to An Existing Multi-Data Center Setup](#)
- [Multi-Data Center Security Modes](#)
- [WLST Commands for Multi-Data Centers](#)

18.1 Before Setting Up a Multi-Data Center

The following prerequisites must be satisfied before beginning the Multi-Data Center (MDC) configuration process documented in [Setting Up a Multi-Data Center](#).

- Ensure you have a fully functioning Oracle Access Management environment with all applicable WebGates configured.
- Partners (WebGates or agents) are anchored to a single Data Center thus, partner registration is done at the individual Data Centers.
- All Data Center clusters must be front ended by a single Load Balancer. The load balancer should send all requests in a user session consistently to the same backend server (persistence, stickiness) and it should be route traffic geographically (geo-affinity).
- Clocks on the machines in which Access Manager and agents are deployed must be in sync. Non-MDC Access Manager clusters require the clocks of WebGate agents be in sync with Access Manager servers. This requirement applies to the MDC as well. If the clocks are out of sync, token validations will not be consistent resulting in deviations from the expected behaviors regarding the token expiry interval, validity interval, timeouts and the like.
- The identity stores in a Multi-Data Center topology must have the same Name.
- WebLogic Server domains do not span Data Centers.
- Any firewall between Data Centers must allow communication over the Oracle Access Protocol (OAP) channel. This entails opening the necessary ports and taking into account the lifetime of the connection. In regards to the latter, the

MaxSessionTime parameter in the WebGate profile should be set to less than the firewall timeout value.

18.2 Primary Multi-Data Center Use Cases

The primary MDC deployments include active-active and active-standby use cases.

Table 18-1 lists the primary MDC use cases.

Table 18-1 MDC Use Cases

MDC Deployment	MDC Policy	Validate Remote Session	Synchronized in DC Servicing User From Remote DC	Terminate Remote Session	User Challenge
Active-Active	SessionMustBeAnchoredToDataCenterServicingUser=false SessionDataRetrievalOnDemand=true Reauthenticate=false SessionDataRetrievalOnDemandMax_retry_attempts=<number> SessionDataRetrievalOnDemandMax_conn_wait_time=<milliseconds> SessionContinuationOnSyncFailure=false MDCGitoCookieDomain=<subdomain>	Yes	Yes	No	When a valid session could not be located in a remote DC
Active-Standby	SessionMustBeAnchoredToDataCenterServicingUser=false SessionDataRetrievalOnDemand=true Reauthenticate=false SessionDataRetrievalOnDemandMax_retry_attempts=<number> SessionDataRetrievalOnDemandMax_conn_wait_time=<milliseconds> SessionContinuationOnSyncFailure=true MDCGitoCookieDomain=<subdomain>	Could not validate as the remote DC is down	No, since the remote DC is down	Could not terminate as the remote DC is down	No Provides seamless access by creating a local session from the details available in the valid cookie

18.3 Setting Up a Multi-Data Center

The MDC feature is disabled by default. To set up an Access Manager MDC, start with an Access Manager cluster, set all MDC global configurations and designate the cluster as the Master Data Center.

Following this, set up the Clone Data Center.

Note:

Before beginning this procedure, ensure that you have completed the points documented in [Before Setting Up a Multi-Data Center](#)

The following sections document the process for setting up an MDC. They include running the commands documented in [WLST Commands for Multi-Data Centers](#).

- [Enabling the Master Data Center](#)
- [Setting Up the Clone Data Center](#)

18.3.1 Enabling the Master Data Center

You can enable the Master Data Center.

To enable:

1. Set up the primary Access Manager Data Center and designate it as the Master. A Master Data Center can be an existing Access Manager cluster or a vanilla installation.

- a. Make note of the clusterId.

The Access Manager bootstrap assigns a unique `clusterId` to the Access Manager cluster. To set a custom clusterId, use the `setMultiDataCentreClusterName` WLST command. See [setMultiDataCentreClusterName](#).

- b. Enable Multi-Data Center mode by running the `enableMultiDataCentreMode` WLST command.

`enableMultiDataCentreMode` sets an Access Manager cluster as Master, by default, and applies the global configurations. See [enableMultiDataCentreMode](#), [Primary Multi-Data Center Use Cases](#).

Note:

To explicitly set the DC type as Master or Clone, use the `setMultiDataCenterType` WLST command documented in [setMultiDataCenterType](#).

- c. Validate the MDC configuration by running the `validateMDCConfig` WLST command. See [validateMDCConfig](#).
 - d. Restart the Admin server.

18.3.2 Setting Up the Clone Data Center

The Master Data Center can be cloned when additional Data Centers are required.

The Data Center set up in [Enabling the Master Data Center](#) is designated as the Master and will be cloned using T2P tools for any additional Data Centers. All configuration

and policy changes are propagated from the Master to a Clone using the WLST commands provided as part of T2P Tooling. The T2P process is explained in the following documents.

See *Administering Oracle Fusion Middleware* for information on T2P when using WebLogic Server.

1. Execute the following commands on the Master Data Center.

Ensure that the AdminServer and all Managed Servers are running. The \$T2P_HOME directory is just a location where all the artifacts of this process are saved.

```
$MIDDLEWARE_HOME/oracle_common/bin/copyBinary.sh -javaHome $JAVA_HOME
  -archiveLoc $T2P_HOME/oamt2pbin.jar
  -sourceMWHomeLoc $MIDDLEWARE_HOME
  -idw true
  -ipl $MIDDLEWARE_HOME/oracle_common/oraInst.loc
  -silent true
  -ldl $T2P_HOME/oam_cln_log;
```

```
$MIDDLEWARE_HOME/oracle_common/bin/copyConfig.sh -javaHome $JAVA_HOME
  -archiveLoc $T2P_HOME/oamt2pConfig.jar
  -sourceDomainLoc $DOMAIN_HOME
  -sourceMWHomeLoc $MIDDLEWARE_HOME
  -domainHostName admin-dcl.us.example.com
  -domainPortNum 7001
  -domainAdminUserName weblogic
  -domainAdminPassword $T2P_HOME/t2p_domain_pass.txt
  -silent true
  -ldl $T2P_HOME/oam_cln_log_config
  -opssDataExport true
  -debug true;
```

2. Copy the following files to the clone machine.

The clone machine should not have any Oracle Access Management software installed on it.

```
$MIDDLEWARE_HOME/oracle_common/bin/pasteBinary.sh
$MIDDLEWARE_HOME/oracle_common/jlib/cloningclient.jar
$MIDDLEWARE_HOME/oracle_common/oraInst.loc
```

3. Execute the following commands on the Clone Data Center to copy all contents of \$T2P_HOME directory from the master to the \$T2P_HOME directory of the clone.

```
$T2P_HOME/pasteBinary.sh -javaHome $JAVA_HOME -al $T2P_HOME/oamt2pbin.jar -tmw
$MIDDLEWARE_HOME -silent true -idw true -esp false
  -ipl $T2P_HOME/oraInst.loc -ldl $T2P_HOME/oam_cln_log_p -silent true
```

```
$MIDDLEWARE_HOME/oracle_common/bin/extractMovePlan.sh -javaHome $JAVA_HOME -al
$T2P_HOME/oamt2pConfig.jar -planDirLoc $T2P_HOME/moveplan/
```

4. Edit the extracted Moveplan.xml on the Clone Data Center to provide relevant details.

Note:

Backup the original Moveplan.xml before editing.

```
cp $T2P_HOME/moveplan/moveplan.xml $T2P_HOME/moveplan/moveplan.xml.org
```

Each Clone Data Center will use a fresh set of OAM related schemas which need to be created using RCU in their respective databases. The new schema names and passwords need to be referenced in the moveplan.

```
$MIDDLEWARE_HOME/oracle_common/bin/pasteConfig.sh -javaHome $JAVA_HOME
-archiveLoc $T2P_HOME/oamt2pConfig.jar
-targetMWHomeLoc $MIDDLEWARE_HOME
-targetDomainLoc $DOMAIN_HOME
-movePlanLoc $T2P_HOME/moveplan/moveplan.xml
-domainAdminPasswordFile $T2P_HOME/t2p_domain_pass.txt
-ldl $T2P_HOME/oam_cln_log_paste_p
-silent true
```

5. Use pack and unpack to copy managed servers on separate hosts.

See *Oracle Fusion Middleware Creating Templates and Domains Using the Pack and Unpack Commands* for details.

6. Configure any or all Clone Data Centers as follows.

- a. Set a unique data center identifier for the clone DC using the `setMultiDataCentreClusterName WLST` command.

```
setMultiDataCentreClusterName(clusterName="DC2")
```

Note:

This step may be skipped if it was already done through the T2P process.

- b. Set the type to Clone for the Clone DC.

```
setMultiDataCenterType(DataCenterType="Clone")
```

Optionally the configuration and policy updates can be disabled on the Clone by executing

```
setMultiDataCenterWrite(WriteEnabledFlag="false").
```

After executing the command, the Clone becomes read only for policy and configuration artifacts. See [setMultiDataCenterWrite](#) for details.

7. Verify access to the Oracle Access Management Console and single sign-on between data centers.

To this point, one master and one clone are set up. Multiple clones can be set up similarly as required by repeating the cloning process. The above commands need to be executed for each of the clone DCs as per the topology using the appropriate cluster name each time.

18.4 Adding A Second Clone to An Existing Multi-Data Center Setup

You can add another clone to an already existing MDC environment.

To add:

1. Register a Partner Profile for the new Clone DC (DC3) on the Master DC.
2. Seed the data center partner on the Master DC.
3. Setup the new Clone DC.
4. Setup replication for the new Clone DC.

5. Customize with transformation rules if required.

The specifics are documented in [Setting Up a Multi-Data Center](#)

18.5 Multi-Data Center Security Modes

A Multi-Data Center relies on the Oracle Access Protocol (OAP) channel for inter data center session management operations and back channel communication. The security mode of the MDC partner profile should match the security mode defined for the Access Manager server: OPEN, SIMPLE or CERT.

Note:

An MDC partner profile is exposed by each data center and used by other data centers to communicate with it. Registering an MDC partner is a two step process. Consider an MDC with three data centers. In DC1, expose an MDC partner profile by creating a 10g or 11g WebGate (DC1_MDC_Partner). Then, register DC1_MDC_Partner in DC2 and DC3 using `addPartnerForMultiDataCentre`. See [addPartnerForMultiDataCentre](#) for details.

The following sections have details about the security modes.

- [OPEN Security Mode](#)
- [SIMPLE Security Mode](#)
- [CERT Security Mode](#)

18.5.1 OPEN Security Mode

OPEN Security Mode is the default mode of the Access Manager deployment. No configuration is needed.

The following is a sample input properties file for use with the `addPartnerForMultiDataCentre` WLST command.

```
remoteDataCentreClusterId=
<CLUSTER ID OF REMOTE DC FOR WHICH THE AGENT IS BEING ADDED>
oamMdcAgentId=
<AGENT ID OF THE REGISTERED PARTNER IN datacenter ABOVE>
PrimaryHostPort=<fully-qualified-host-name:OAM-port>
  for example:PrimaryHostPort=adc.example.com:5575
SecondaryHostPort=<fully-qualified-host-name:OAM-port>
  for example:SecondaryHostPort=adc.example.com:5577
AccessClientPasswd=<ACCESS CLIENT PASSWORD OF oamMdcAgentId IN datacenter>
oamMdcSecurityMode=OPEN
agentVersion=<WEBGATE AGENT VERSION 10g or 11g>
#NA ----> Not Applicable
trustStorePath=NA
keyStorePath=NA
globalPassPhrase=NA
keystorePassword=NA
```

18.5.2 SIMPLE Security Mode

Follow the instructions in [Configuring Simple Mode Communication with Access Manager](#) to set up the Access Manager servers in SIMPLE mode. In short, create an

MDC partner profile in each of the member data centers in SIMPLE mode, and add it to each of the other data centers.

The following is a sample input properties file for use with the `addPartnerForMultiDataCentre WLST` command.

```
remoteDataCentreClusterId=
  <CLUSTER ID OF REMOTE DC FOR WHICH THE AGENT IS BEING ADDED>
oamMdcAgentId=<AGENT ID OF THE REGISTERED PARTNER IN datacenter ABOVE>
PrimaryHostPort=<fully-qualified-host-name:OAM-port>
  for example:PrimaryHostPort=adc.example.com:5575
SecondaryHostPort=<fully-qualified-host-name:OAM-port>
  for example:SecondaryHostPort=adc.example.com:5577
AccessClientPasswd=<ACCESS CLIENT PASSWORD OF oamMdcAgentId IN datacenter>
oamMdcSecurityMode=SIMPLE
agentVersion=<WEBGATE AGENT VERSION 10g or 11g>

#Copy the oamclient-truststore.jks & oamclient-keystore.jks from
#<DOMAIN_HOME>/output/webgate-ssl/ from 'datacenter with cluster ID
#remoteDataCentreClusterId' above into the local DC say /scratch/MDCartifacts/ and
#refer them in the below parameters

trustStorePath=</scratch/MDCartifacts/oamclient-truststore.jks>
keyStorePath=</scratch/MDCartifacts/oamclient-keystore.jks>

#Use the online WLST command displaySimpleModeGlobalPassphrase() to list
#the global passphrase in SIMPLE mode. Admins can also update this in the UI
#@ System Configuration-->Access Manager-->Access Manager Settings-->
#Access Protocol-->Simple Mode Configuration-->Global Passphrase.
#globalPassPhrase & keystorePassword are the same for SIMPLE mode

globalPassPhrase=<passphrase resulted in using the above steps>
keystorePassword=<same as globalPassPhrase>
```

18.5.3 CERT Security Mode

Follow the instructions in [Configuring Cert Mode Communication for Access Manager](#) to set up the Access Manager servers in CERT mode. Create an MDC partner in each of the member data centers in CERT mode. Generate the `clientTrustStore.jks` and `clientKeyStore.jks` KeyStores for the partners to communicate in CERT mode.

In an MDC setup, each Clone data center is a replica of the Master data center. For the newly cloned data centers to communicate with the existing data centers in CERT mode, the KeyStores generated may be reused across data centers. However, while configuring the domain across multiple nodes (such as adding a new OAM server to a new host), ensure that the new host's file system has the required artifacts stored in the same directory structure as that of the AdminServer node.

1. Run the following `openssl` command from a Linux command prompt to generate `aaa_key.pem` and `aaa_req.pem`.

```
openssl req -new -keyout aaa_key.pem -out aaa_req.pem -utf8
```

Use the `certreq` command to generate the certificate and chain.

2. Create `aaa_cert.pem` using the following procedure.
 - a. Open `aaa_req.pem` in a text editor and copy the contents. Exclude the trailing spaces from your selection.

- b. Paste the copied text into Signcsr.
Include [-----BEGIN CERTIFICATE REQUEST----- and -----END CERTIFICATE REQUEST-----].
 - c. Copy the output into a text editor and save it as `aaa_cert.pem`.
3. Create `aaa_chain` using the following procedure.
 - a. Open `certreq`.
 - b. Click on `chain.pem` and copy/paste the contents into a text editor and save it as `aaa_chain.pem`.
Excluding trailing and leading spaces from your selection.

4. Encrypt the private key (`aaa_key.pem`) using the following command.

```
openssl rsa -in aaa_key.pem -passin pass: -out aaa_key.pem -passout
pass:Welcome1 -des
```

The password used in this command must be defined as the access client password or agent key password while registering the MDC partner.

5. Copy `aaa_key.pem`, `aaa_cert.pem` and `aaa_chain.pem` to a temporary location.

For example, `/tmp/clientCertArtifacts/`

6. Convert `aaa_cert.pem` and `aaa_key.pem` into DER format using one of the following commands.

```
-openssl x509 -in /tmp/clientCertArtifacts/aaa_cert.pem -inform PEM -out
/tmp/clientCertArtifacts/aaa_cert.der -outform DER;
```

```
-openssl pkcs8 -topk8 -nocrypt -in /tmp/clientCertArtifacts/aaa_key.pem
-inform PEM -out /tmp/clientCertArtifacts/aaa_key.der -outform DER;
```

7. Import the `aaa_key.der` and `aaa_cert.der` into `clientKeyStore.jks`; and the `aaa_chain.pem` into `clientTrustStore.jks` with the below steps

```
-cd $IDM_HOME/oam/server/tools/importcert/;
```

```
-unzip importcert.zip;
```

```
-java -cp importcert.jar
oracle.security.am.common.tools.importcerts.CertificateImport -keystore
/tmp/clientCertArtifacts/clientKeyStore.jks -privatekeyfile
/tmp/clientCertArtifacts/aaa_key.der -signedcertfile
/tmp/clientCertArtifacts/aaa_cert.der -storetype jks -genkeystore yes
```

```
-keytool -importcert -file /tmp/clientCertArtifacts/aaa_chain.pem -trustcacerts
-keystore /tmp/clientCertArtifacts/clientTrustStore.jks -storetype JKS
```

Enter the keystore passwords when prompted. The password needs to be defined in the input properties file for the `addPartnerForMultiDataCentre WLST` command as well.

8. If not done when creating the certificates for the WebGate, import the `aaa_key.der` and `aaa_cert.der` formatted certificates into the `.oamkeystore` using the same Oracle provided `importcert.jar` used in the previous step.

```
-java -cp importcert.jar
oracle.security.am.common.tools.importcerts.CertificateImport
```

```

-keystore /scratch/Oracle/Middleware/domains/
base_domain/config/fmwconfig/.oamkeystore -privatekeyfile
/tmp/clientCertArtifacts/aaa_key.der -signedcertfile
/tmp/clientCertArtifacts/aaa_cert.der -alias mycertmodel -storetype JCEKS
  
```

alias is the alias name defined when setting CERT mode in Access Manager.

The following is a sample input properties file for use with the `addPartnerForMultiDataCentre` WLST command.

```

remoteDataCentreClusterId=
<CLUSTER ID OF REMOTE DC FOR WHICH THE AGENT IS BEING ADDED>
oamMdcAgentId=<AGENT ID OF THE REGISTERED PARTNER IN datacenter ABOVE>
PrimaryHostPort=<fully-qualified-host-name:OAM-port>
  for example:PrimaryHostPort=adc.example.com:5575
SecondaryHostPort=<fully-qualified-host-name:OAM-port>
  for example:SecondaryHostPort=adc.example.com:5577
AccessClientPasswd=<ACCESS CLIENT PASSWORD OF oamMdcAgentId IN datacenter>
oamMdcSecurityMode=CERT
agentVersion=<WEBGATE AGENT VERSION 10g or 11g>

trustStorePath=</tmp/clientCertArtifacts/clientTrustStore.jks >
keyStorePath=</tmp/clientCertArtifacts/clientKeyStore.jks >

globalPassPhrase=NA

#use keystore password used for generating keystore in the previous step
keystorePassword=<keystore password given while generating keystore>
  
```

18.6 WLST Commands for Multi-Data Centers

The following WebLogic Scripting Tool (WLST) commands are specific to Multi-Data Center deployment. More information is in the following sections.

- [enableMultiDataCentreMode](#)
- [disableMultiDataCentreMode](#)
- [addPartnerForMultiDataCentre](#)
- [removePartnerForMultiDataCentre](#)
- [setMultiDataCenterType](#)
- [setMultiDataCenterWrite](#)
- [setMultiDataCentreClusterName](#)
- [validateMDCConfig](#)
- [exportAccessStore](#)
- [importAccessStore](#)

See Also *WLST Command Reference for WebLogic Server*.

18.7 enableMultiDataCentreMode

Online command used to enable Multi-Data Center mode.

Description

This command enables Multi-Data Center mode. It takes a value equal to the full path to, and name of, the MDC.properties file.

Note:

Setting the SSO Token version to 5 is not supported from the administration console. To do this, modify the Access Manager Settings page and run the enableMultiDataCentreMode WLST command to set.

Syntax

```
enableMultiDataCentreMode(propfile=" ../MDC_properties/oamMDCProperty.properties")
```

Argument	Definition
<i>propfile</i>	Mandatory. Takes a value equal to the full path to, and name of, the oamMDCProperty.properties file. Table 18-2 documents the properties that comprise the file. The example (following the table) is a sample oamMDCProperty.properties file.

Table 18-2 oamMDC.properties Properties

Property	Definition
SessionMustBeAnchoredToDataCenterServicingUser	Takes a value of True (Invalidate) or False (No Invalidation).
SessionDataRetrievalOnDemand	Takes a value of True (Cross DC retrieval) or False (No). Data retrieval can be turned off without disabling MDC. If False, session data is not transferred but SSO is still performed as the user moves across DCs. NOTE: SessionDataRetrievalOnDemand must be set to False when deploying in Co-existence mode.
Reauthenticate	Takes a value of True (force reauthentication) or False (No forced reauthentication).
SessionDataRetrievalOnDemandMax_retry_attempts	Takes a value equal to a binary that represents the number of times to retry data retrieval when it fails. Default is 2.
SessionDataRetrievalOnDemandMax_conn_wait_time	Takes a value equal to a binary that represents the total amount of time in seconds to wait for a connection. Default is 1000.
SessionContinuationOnSyncFailure	Decides the session adoption action on fail over. When set to 'true', the session will continue on the DC servicing the current request even though the parent DC is down/not reachable. The session will be created in the DC servicing the current request from the mandatory minimal information available in the incoming token. When set to 'false', the user will be challenged on fail-over scenarios.

Table 18-2 (Cont.) oamMDC.properties Properties

Property	Definition
MDCGitoCookieDomain	Specifies the domain with which the OAM_GITO cookie should be set.
omain	In MDC deployments where a common cookie domain hierarchy cannot be derived, this setting should be commented or removed as described in Inactivity time outs scenario.

Table 18-3 Properties for MDC.properties File

Property Name	Description
SSOCookieDomain	Takes a value equal to the single sign-on cookie domain.
SSOCookieDomainEnabled	When set to true, the single sign-on cookie domain is enabled.
Reauthenticate	When set to true, the user is always authenticated when the first request arrives at a given data center. In our example, if the user is already authenticated by NYDC and is now redirected to LDC, the user will be authenticated again.
SessionDataRetrievalOnDemand	When set to true, the session is retrieved from the previous data center. When set to false, the MDC will behave in "active-failover" mode - which means session synchronization will not happen.
SessionMustBeAnchoredToDataCenterServicingUser	This is only relevant when "SessionDataRetrievalOnDemand" is set to true. When set to true the session is removed from the previous data center so the user will have only one active session across the data centers.
SessionDataRetrievalOnDemandMax_retry_attempts	This specifies the number of attempts to be made to retrieve the session from the other data center.
SessionDataRetrievalOnDemandMax_conn_wait_time	This specifies in milliseconds the time out value for session retrieval.
SessionContinuationOnSyncFailure	When set to true, this specifies if the user session should continue when the session fetch among data centers fails due to the remote DC being unreachable.

Sample oamMDCProperty.properties File

```
SessionMustBeAnchoredToDataCenterServicingUser=false
SessionDataRetrievalOnDemand=true
Reauthenticate=true
SessionDataRetrievalOnDemandMax_retry_attempts=3
SessionDataRetrievalOnDemandMax_conn_wait_time=80
SessionContinuationOnSyncFailure=true
```

```
#MDCGitoCookieDomain=.example.com <This setting should be provided only if there is
a common cookie subdomain across the WGs and DCs>
```

Example

The following command enables this data center.

```
enableMultiDataCentreMode(propfile="../MDC_properties/oamMDCProperty.properties")
```

18.8 disableMultiDataCentreMode

Online command used to disable Multi-Data Center mode.

Description

This command disables Multi-Data Center mode.

Syntax

```
disableMultiDataCentreMode()
```

There are no arguments for this command.

Example

The following command disables Multi-Data Center mode.

```
disableMultiDataCentreMode()
```

18.9 addPartnerForMultiDataCentre

In an MDC deployment with n number of Data Centers, each Data Center has a registered partner to communicate with each of the other $(n-1)$ Data Centers. This makes the total number of partner registrations $(n) \times (n-1)$. This online command is used to add a partner for inter Data Center OAP communication.

Note:

An MDC partner profile is exposed by each data center and used by other data centers to communicate with it. Registering an MDC partner is a two step process. Consider an MDC with three data centers. In DC1, expose an MDC partner profile by creating an OAM WebGate (DC1_MDC_Partner). Then, register DC1_MDC_Partner in DC2 and DC3 using `addPartnerForMultiDataCentre`. See [addPartnerForMultiDataCentre](#) for details.

Description

This command adds a partner to the Data Center. It takes a value equal to the full path to, and name of, the `partnerInfo.properties` file.

Syntax

```
addPartnerForMultiDataCentre(propfile="../MDC_properties/partnerInfo.properties")
```

Argument	Definition
<i>propfile</i>	Mandatory. Takes a value equal to the path to, and name of, the <code>partnerInfo.properties</code> file.

Argument	Definition
<i>RESTEndpoint</i>	Optional. Takes as a value the HTTP/HTTPS URL from which the Access Manager REST services can be accessed.

Table 18-4 documents the properties that comprise `partnerInfo.properties`. See [Multi-Data Center Security Modes](#) for properties file samples.

Table 18-4 *partnerInfo.properties* Properties

Property	Definition
<code>remoteDataCentreClusterId</code>	Cluster id of the remote Data Center with which the OAP communication needs to be established.
<code>oamMdcAgentId</code>	Partner ID of the registered partner profile in the remote Data Center. The "allow management operations" flag for this partner should be set in the remote Data Center.
<code>PrimaryHostPort</code>	Takes a <i>fully-qualified-host-name:OAM-port</i> for the primary Access Manager server corresponding to the remote DC identified by <code>remoteDataCentreClusterId</code> ; for example: <code>PrimaryHostPort=abc.example.com:5575</code>
<code>SecondaryHostPort</code>	Takes a <i>fully-qualified-host-name:OAM-port</i> for the secondary Access Manager server corresponding to the remote DC identified by <code>remoteDataCentreClusterId</code> ; for example: <code>SecondaryHostPort=abc.example.com:5577</code> Consider an OAM MDC member Data Center with two managed servers at <code>abc.example.com</code> with ports as follows: <code>oam_server1 (5575)</code> and <code>oam_server2 (5577)</code> . High availability/failover of the OAP SDK partner can be achieved by setting the <code>PrimaryHostPort</code> and <code>SecondaryHostPort</code> as below. <code>PrimaryHostPort=abc.example.com:5575</code> <code>SecondaryHostPort=abc.example.com:5577</code>
<code>AccessClientPasswd</code>	The access client password of the MDC partner registered in the remote Data Center.
<code>oamMdcSecurityMode</code>	Defines the MDC security mode. Takes a value of OPEN/SIMPLE/CERT. (CERT Mode is preferred, SIMPLE is fine but OPEN is discouraged.) For SIMPLE and CERT modes, the following values should be supplied appropriately. For OPEN mode, these values are not applicable. See Multi-Data Center Security Modes .
<code>agentVersion</code>	Valid agent version 11g/10g.
<code>trustStorePath</code>	Absolute path to the truststore file [SIMPE/CERT].
<code>keyStorePath</code>	Absolute path to the keyStore file [SIMPLE/CERT].
<code>globalPassPhrase</code>	Global passphrase set during the partner registration [SIMPLE/CERT].

Table 18-4 (Cont.) partnerInfo.properties Properties

Property	Definition
keystorePassword	Key store password set during partner configuration [SIMPLE/CERT].

Example

The following command defines this data center as a Master.

```
addPartnerForMultiDataCentre(propfile="../MDC_properties/partnerInfo.properties")
```

18.10 removePartnerForMultiDataCentre

Online command used to remove a registered remote partner from the Data Center configuration.

Description

This command removes a registered remote partner from a configured Data Center. It takes a value equal to a valid remoteDataCentreClusterId.

Syntax

```
removePartnerForMultiDataCentre("<cluster_ID>")
```

Argument	Definition
<i>cluster_ID</i>	Mandatory. Takes a string value equal to the cluster ID.

Example

The following command defines the partner to be removed.

```
removePartnerForMultiDataCentre("99bf9-adc2120609")
```

18.11 setMultiDataCenterType

Online command used to set the type of data center - either Master or Clone.

Description

In an MDC deployment one Data Center is designated as the Master and the others as a Clone. Essentially all MDC wide global configurations and policy updates should be applied to the Master and propagated to the Clones. This command sets the type of the data center. Values are Master or Clone.

Syntax

```
setMultiDataCenterType(DataCenterType="<Master|Clone>")
```

Argument	Definition
<i>DataCenterType</i>	Mandatory. Takes a string value of Master or Clone.

Example

The following command defines this data center as a Master.

```
setMultiDataCenterType(DataCenterType="Master")
```

18.12 setMultiDataCenterWrite

Online command used to set write protection for modifications to system and policy configurations on the Clone Data Center.

Description

A Clone Data Center can be write protected by setting `WriteEnabledFlag` to false. In this case, the Clone Data Center will not allow updates through the Oracle Access Management Console or WLST commands. Data synchronization will still continue to update as the command is used to write protect the Clone Data Center against accidental updates after the initial set up is complete.

Syntax

```
setMultiDataCenterWrite(WriteEnabledFlag="<true|false>")
```

Argument	Definition
<i>WriteEnabledFlag</i>	Mandatory. Takes a string value of true or false.

Example

The following example protects the Clone Data Center from accidental overwrites.

```
setMultiDataCenterWrite(WriteEnabledFlag = "false")
```

18.13 setMultiDataCentreClusterName

Online command to set the cluster name of the Data Center to the supplied string.

Description

This command sets the Multi-Data Center cluster name. Value is a string.

Syntax

```
setMultiDataCentreClusterName(clusterName="<string_value>")
```

Argument	Definition
<i>clusterName</i>	Mandatory. Takes a string equal to the cluster name.

Example

The following command enables this data center.

```
setMultiDataCentreClusterName(clusterName="MyCluster")
```

18.14 validateMDCConfig

Online command used to insure the Multi-Data Center configuration is correct.

Description

This command validates that the required entries in the Multi-Data Center configuration are present in `oam-config.xml`. For the MDC solution, a new Access Manager event named `mdc_session_update` is required to create or update MDC sessions during authorization. The Access Manager event model requires a set of configurations to be present in the `oam-config.xml` configuration file. The required configurations cannot be added statically so `validateMDCConfig` validates the required entries for `mdc_session_update` and seeds any configurations not already present.

Syntax

```
validateMDCConfig()
```

There are no arguments for this command.

Example

The following command validates the MDC configuration.

```
validateMDCConfig()
```

18.15 exportAccessStore

Online command to create a ZIP file of the Master Data Center UDM metadata.

Description

This command will create a ZIP file of the Master Data Center UDM metadata.

Syntax

```
exportAccessStore(toFile="<name and location of ZIP", namePath="/")
```

Example

```
exportAccessStore(toFile="/master/location/dclmetadata.zip", namePath="/")
```

18.16 importAccessStore

Online command to import a ZIP file of the Master Data Center UDM metadata to a Clone Data Center.

Description

This command will import a ZIP file of the Master Data Center UDM metadata to the Clone Data Center.

Syntax

```
importAccessStore(fromFile="<name and location of ZIP", namePath="/")
```

Example

```
importAccessStore(fromFile="/master/location/dclmetadata.zip", namePath="/")
```

Synchronizing Data In A Multi-Data Center

The Multi-Data Center infrastructure can be configured to keep Access Manager data synchronized across multiple data centers. This can be done using the Automated Policy Synchronization Replication Service or data can be replicated manually.

The following topics describe how to synchronize across data centers and replicate data:

- [Understanding the Multi-Data Center Synchronization](#)
- [Enabling Data Replication](#)
- [Synchronizing Master and Clone Metadata](#)
- [Customizing Transformation Rules](#)
- [Modifying a Rule Document](#)
- [Using REST API for Replication Agreements](#)
- [Replicating Domains in Identity Manager Deployments](#)
- [Best Practices for Replication](#)

19.1 Understanding the Multi-Data Center Synchronization

The Multi-Data Center (MDC) infrastructure can be configured to keep Access Manager data synchronized across multiple data centers. The Automated Policy Synchronization (APS), a replication mechanism introduced in 11g removes administrator and manual intervention from the data synchronization process.

Policy, system configuration, and partner metadata are all synchronized with APS.

Note:

T2P tooling is required for creating a Clone (also referred to as a Consumer) from a Master (also referred to as a Supplier). Once the MDC infrastructure is deployed, APS can be enabled to automatically sync any changes from the Master to the Clones.

See [Before Setting Up a Multi-Data Center](#).

APS (also referred to as the Replication Service) is a set of REST API. The binaries are installed as part of the Access Manager application and deployed in the AdminServer. It is disabled by default but can be enabled by setting the `oracle.oam.EnableMDCReplication` property to true. After enabling the service, create a pull model Replication Agreement between the Clone data center and the Master. The Clone polls for changes from the Master as long as the Replication

Agreement is valid for it. Conversely, the Master will respond to the Clone's request as long as it finds a valid replication agreement. The Clone applies the changes locally.

Note:

APS is optional; administrator-initiated import and export based replication is still available using the T2P tooling and WLST command procedure used previous to this release.

When setting up the Replication Service, the following may occur:

- Establishment of a Replication Agreement with the registration of one data center as a replication Clone and another in a separate geographical location as its Master; the changes are pulled from the Master and applied to the Clone.
- Definition of data center specific configurations which may not be replicated across data centers.
- Tracking of Access Manager configuration changes in each data center and querying the current replication state in any of the data centers.
- Generation of a changelog which can be applied in the context of a similar setup running in another data center.
- Trigger of a pull from the Master data center if there is a need; for example, if automated replication fails.
- Replication of Access Manager configuration artifacts in the Master-Clone model.

Note:

APS does not sync IDS Profiles, OAM Keystores, and Oracle Platform Security Services artifacts (jps-config.xml changes, credential store configuration and the like).

The following sections contain additional details.

- [How Replication Works](#)
- [Understanding the Replication Agreement](#)
- [About Synchronizing Data Manually in a Multi-Data Center](#)

19.1.1 How Replication Works

Replication works in a Master-Clone topology. In this topology, multiple Clones pull changes from a single Master. One Data Center is defined by the administrator as the Master and one or more other Data Centers are Clones.

The administrator makes changes to the Master that are replicated to the Clones. Only Master to Clone replication is supported; changes to Clones are not replicated back to the Master.

Note:

Multi-master replication is not supported.

To partake in replication, the Master data center (initiator of the replication) and the Clone data center (receiver of the changes) must have a Replication Agreement stored in the Access Manager data store. [Table 19-1](#) documents the states in which replication can be deployed.

Table 19-1 Replication States

State	Definition
Active	An Access Manager domain (including Admin and managed servers) is setup to serve access requests. In an active state, the Access Manager server provides the web access management functionality without additional MDC features.
Bootstrapping	This state is optional for some Data Centers; for example, the first one in an MDC topology. A Data Center goes through this intermediate state when added to an existing MDC topology. The new DC contacts the master and bootstraps itself to the same state. The bootstrap includes synchronizing the server keys, policy artifacts, partners, and system configuration. After completion of bootstrapping, the DC will be Replication Ready.
Replication Ready	In this state, MDC is enabled, the DC is made part of the topology, and the replication service is enabled. Once enabled, a clone can be registered with the master via a Replication Agreement. Once established, clone DCs can query and start pulling changelogs from the master.

[Figure 19-1](#) illustrates the replication flow.

Figure 19-1 Replication Flow

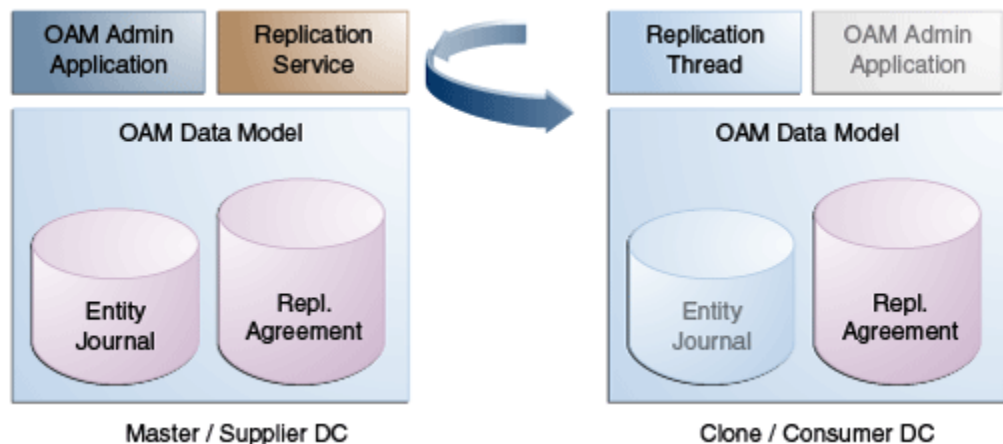

Each Clone pulls changes from the Master. A replication thread runs on the Clone after the pre-configured interval of time and fetches changes from the Replication Service (REST endpoint) running on the Master environment.

For every cloned environment, the Master keeps track of a change sequence number indicating when it was last synced. The Master also keeps track of the list of changes

(Create/Update/Delete) that have been pulled by the Clones in a changelog using specific change sequence numbers. When updating configuration metadata, the Clone can also change environment specific parameter values depending on transformation rules.

See [Customizing Transformation Rules](#) .

19.1.2 Understanding the Replication Agreement

Configuration changes (defined as *journals*) are replicated from a Master node to Clone nodes. On receiving the journals, each node updates its configuration to match the journal and remain in a synchronized state. The nodes, though, need to enter a Replication Agreement to receive change journals.

When a new data center is added to an existing MDC topology, it has to bootstrap itself to be in sync with the existing data centers. This bootstrap operation will get the current Access Manager policies, system configuration, partner metadata and server keys for the existing MDC topology. After the bootstrap operation, the new data center captures the last change sequence number from the topology's Master so that during replication it can be used to determine the current state.

Note:

Automated bootstrap is the ideal scenario but you can execute T2P tooling first to ensure the Master and Clones are in the same state.

To establish a Replication Agreement, the Clone data center must know the Master's changelog sequence number. If the data center is added to the topology on 'day 0' and the Replication Agreement was created on 'day 1', there is a need to bootstrap again. To avoid this and to keep the flow simple, creating a Replication Agreement should take care of the bootstrap and actual replication agreement creation. The steps to create the Replication Agreement.

See [Setting Up a Multi-Data Center](#).

19.1.3 About Synchronizing Data Manually in a Multi-Data Center

Data in an MDC topology can also be synced manually. The manual option uses WLST export and import calls to migrate the data from one data center to another. Partner profiles and policies should both be exported and imported using WLST.

See Access Manager WLST Commands in *Oracle Fusion Middleware WebLogic Scripting Tool Command Reference for Identity and Access Management*.

19.2 Enabling Data Replication

Data Replication on the Master and Clone data centers is enabled by default. Setting the flag `-Doracle.oam.EnableMDCReplication` to `true` is not mandatory.

Validate the Replication REST endpoints in Master and Clone data centers as follows:

1. Validate that the REST endpoints are enabled in the Master data center.

```
curl -u weblogic:password 'https://supplier.example.com:7002/oam/services/rest/_replication/hello'
```

2. Validate that the REST endpoints are enabled in the Clone data center.

```
curl -u weblogic:password 'https://supplier.example.com:7002/oam/services/rest/_replication/hello'
```

3. Repeat the process of validation on all Clone data centers.

19.3 Synchronizing Master and Clone Metadata

The process for syncing metadata across an MDC involves first syncing Access Manager UDM metadata and then creating a replication agreement.

See [Understanding the Replication Agreement](#) .

The following topics describe how to synchronize master and clone metadata:

- [Synchronizing the UDM Metadata](#)
- [Creating a Replication Agreement](#)
- [Modifying a Replication Agreement](#)

19.3.1 Synchronizing the UDM Metadata

You must synchronize the UDM Metadata before you can create the replication agreement.

To sync Access Manager UDM metadata stored in the Master to all Clones:

1. Execute the `exportAccessStore WLST` command on the Master Data Center to create a ZIP file containing the UDM metadata.

```
exportAccessStore(toFile="/master/location/dclmetadata.zip",
  namePath="/")
```

2. Copy `dclmetadata.zip` to the Clone DC location.

3. Execute the `importAccessStore WLST` command on the Clone Data Center to import the UDM metadata.

```
importAccessStore(fromFile="/clone/location/dclmetadata.zip",
  namePath="/")
```

4. Repeat on all Clone DCs.

19.3.2 Creating a Replication Agreement

Creating a Replication Agreement is a one time operation which will enable the Clone data center(s) to pull changes from the Master data center.

The replication agreement can be created using any REST client. In this procedure, we use the standard Curl utility.

After you execute this command, the following results occur:

- Insert an entry in the Master's Replication Agreement store containing details regarding the Clone that wants to pull changes.
- Insert an entry in the Clone's Replication Agreement store containing details regarding the Master from which it will pull changes. Replication configuration values like the poll interval will also be set.

To create a replication agreement:

1. Ensure the Master and Clone DC REST endpoints are up and running.
2. Execute the following command on the Master DC.

This command will use the `repluser` specified for replication queries from the Master to the Clone. `repluser` is expected to be available in the default identity stores for all involved DCs.

```
curl -u <repluser> -H 'Content-Type: application/json' -X POST
'https://supplier.example.com:7002/oam/services/rest/
_replication/setup' -d '{"name":"DC12DC2",
"source":"DC1","target":"DC2","documentType":"ENTITY"}'
```

The following is an example of output for the command.

```
{"enabled":"true","identifier":"201409231329353668","ok":"true",
"pollInterval":"900","startingSequenceNumber":"110","state":"READY"}
```

Be sure to note the values of the replication identifier, `pollInterval` and `startingSequenceNumber`. The identifier is a reference specific to this Replication Agreement and is used for replication related queries. The `pollInterval` is a value (in seconds) after which the Clone will poll for changes against the Master. (Typically policy and configuration are not changed often so this number can be as high as the default value of 900 seconds.) The `startingSequenceNumber` is the value before which all records will be unavailable. In the example, all records before the value of 110 are unavailable. It is implicit that bootstrapping happened before creating the Replication Agreement thus the Clone can start pulling changes from sequence number 110. The Clone also has an entry created in its local replication table which keeps track of the last sequence number. The starting sequence process is illustrated in [Figure 19-2](#).

Figure 19-2 Starting Sequence Illustrated

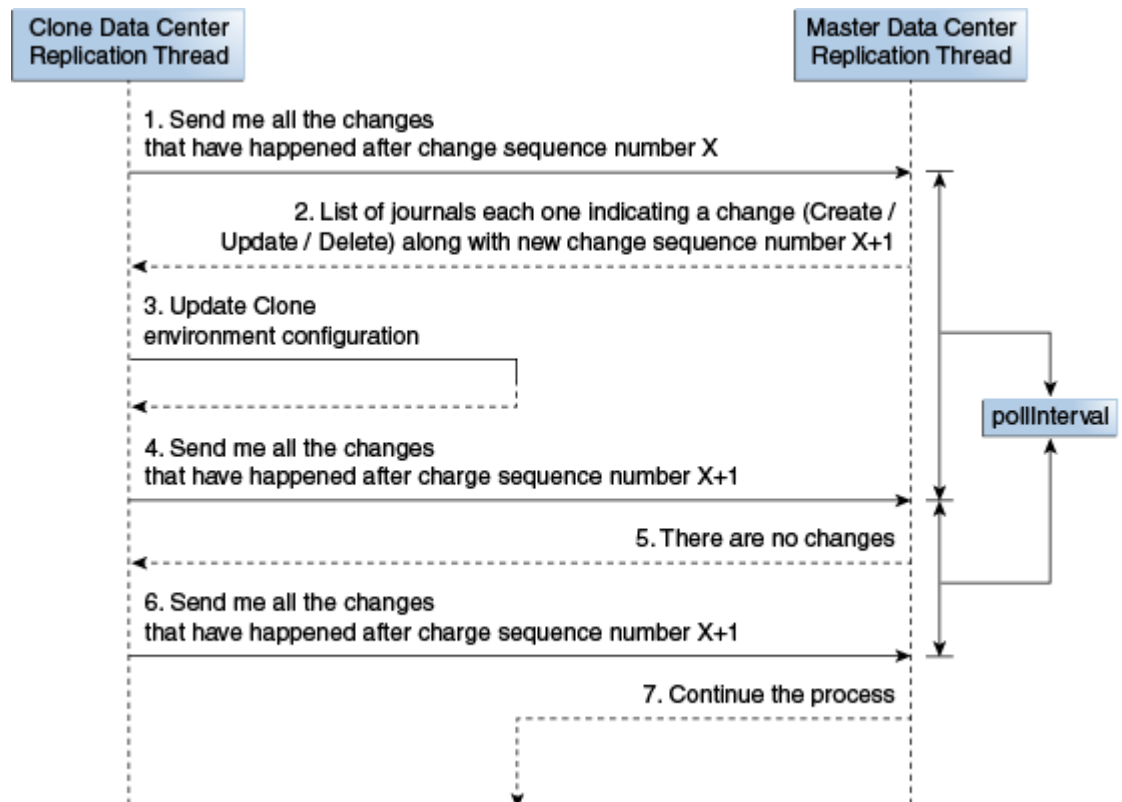

The create replication agreement command will return details of an already existing replication agreement if applicable. In this case, the value of ok will be false.

```
{ "enabled": "true", "identifier": "201409231329353668", "ok": "false",
  "pollInterval": "900", "startingSequenceNumber": "110",
  "state": "READY" }
```

Note:

If a specific user needs to be used for replication, the user's credentials can be provided in the command in the format "BASIC base64(user:password)". For example, "BASIC base64(weblogic:welcome1)" is specified as "BASIC d2VibG9naWM6d2VsY29tZTE=" in the following command.

```
curl -u <repluser> -H 'Content-Type: application/json' -X POST
  'https://supplier.example.com:7002/oam/services/rest/
  _replication/setup' -d
  '{ "source": "DC1", "target": "DC2", "documentType": "ENTITY", "config":
  { "entry": { "key": "authorization", "value": "BASIC
  d2VibG9naWM6d2VsY29tZTE=" } } }'
```

Basic Authorization is supported for replication REST API.

3. Restart the Master and Clone AdminServers.

Once the replication agreement is created and the AdminServers restarted, the Clone will start polling for changes. The default poll interval is '900' seconds or 15 minutes. The poll interval can be changed by executing an edit replication agreement command. For example, the following command will change the polling interval to 60 seconds. Restart the Clone AdminServer after running the command..

```
curl -u <repluser> -H 'Content-Type: application/json' -X PUT
  'https://supplier.example.com:7002/oam/services/rest/
  _replication/201409231
  329353668' -d '{ "pollInterval": "60", "replicaType": "CONSUMER" }'
```

To query the details of a Clone's replication agreement (including the polling interval), use the following command.

```
curl -u <repluser>
  'https://supplier.example.com:7002/oam/services/rest/_replication/201409231
  329353668?type=consumer'
```

The output would be similar to the following.

```
{ "enabled": "true", "identifier": "201409231329353668", "ok": "true",
  "pollInterval": "60", "startingSequenceNumber": "110", "state": "READY" }
```

To query the details of a Master's replication agreement (including the polling interval), use the following command.

```
curl -u <repluser>
  'https://supplier.example.com:7001/oam/services/rest/_replication/201409231
  329353668'
```

The output would be similar to the following. (The poll Interval of the Master's replication agreement does not affect the actual replication.)

```
{ "enabled": "true", "identifier": "201409231329353668", "ok": "true",
  "pollInterval": "3600", "startingSequenceNumber": "110", "state": "ACTIVE" }
```

In R2PS3, the following command can also be used on the Master or the Clone to get details of any replication agreements. In cases where the replication agreement identifier is unknown, this command can be used to list all the replication agreement identifiers for input in the previous commands.

```
curl -k -u weblogic
'https://oamadmin.example.com:7002/oam/services/rest/_replication/agreements'
```

Sample output 1:

```
{ "featureEnabled": "true", "identifiers": "201411211137273612", "ok": "true" }
```

Sample output 2:

```
{ "featureEnabled": "true", "identifiers":
["201411211137273612", "201411211137273900"], "ok": "true" }
```

To remove a replication agreement, first disable it on the Clone side, then disable it on the Master side and then delete it on both sides. The following commands illustrate this process.

```
curl -u <repluser> -H 'Content-Type: application/json' -X PUT
'https://supplier.example.com:7002/oam/services/rest/_replication/201409231
329353668' -d '{"enabled": "false", "replicaType": "CONSUMER"}'
```

```
curl -u <repluser> -H 'Content-Type: application/json' -X PUT
'https://supplier.example.com:7002/oam/services/rest/_replication/201409231
329353668' -d '{"enabled": "false", "replicaType": "SUPPLIER"}'
```

```
curl -u weblogic:welcome1 -H 'Content-Type: application/json' -X DELETE
'https://supplier.example.com:7001/oam/services/rest/_replication/201409231
329353668'
```

19.3.3 Modifying a Replication Agreement

Using the Replication Agreement identifier, changes can be made to the Replication Agreement configuration. Replication Agreement properties (enabled status, poll interval and the like) can be updated by executing a REST request at the Master's endpoint. Either the Master or Clone Replication Agreement will be updated as specified by the value of the replicaType parameter. The clone will poll for changes, apply them and wait the duration specified as the pollInterval.

In this example, the value of pollInterval will be changed to 60 seconds.

Service responds back with JSON object that is the status of replication agreement before making the change. You need to fetch replication agreement status again to see updated configuration.

1. Query the existing replication agreements using the following command and obtain the replication Identifier, replId that needs to be used in the following steps.

```
curl -k -u weblogic:password 'https://oamadmin1-dc1.poc.com:7002/oam/services/
rest/_replication/agreements'
```

Note: If there are multiple replication agreements, select the identifier for which replication agreement needs to be modified by querying the corresponding Clone data center.

- Execute the following command to get the current status of the Replication Agreement in Clone machine:

```
curl -k -u weblogic:password 'https://oamadmin1-dcl.poc.com:7002/oam/services/rest/_replication/201409040157218184?type=consumer'
```

The JSON response would be:

```
{"enabled": "true", "identifier": "201409040157218184", "ok": "true", "pollInterval": "900", "startingSequenceNumber": "101", "state": "READY"}
```

- Execute the following command to modify the value of pollInterval in Clone machine:

```
curl -k -u weblogic:password 'Content-Type: application/json' -X PUT 'https://oamadmin1-dcl.poc.com:7002/oam/services/rest/_replication/201409040157218184' -d '{"pollInterval": "60", "replicaType": "CONSUMER"}
```

The JSON response would be:

```
{"enabled": "true", "identifier": "201409040157218184", "ok": "true", "pollInterval": "60", "startingSequenceNumber": "101", "state": "READY"}
```

- Restart the AdminServer on Clone machine.
- Execute the following command to get the current status of the Replication Agreement.

This will validate that the change has been made. Note the value of pollInterval in the JSON Response is different from the value returned in the first step of this procedure.

```
curl -k -u weblogic:password 'https://oamadmin1-dcl.poc.com:7002/oam/services/rest/_replication/201409040157218184?type=consumer'
```

The JSON response would be:

```
{"enabled": "true", "identifier": "201409040157218184?", "ok": "true", "pollInterval": "60", "startingSequenceNumber": "101", "state": "READY"}
```

Table 19-2 Modifying Replication Agreement Properties

Property	Modification Command
BatchSize	<p>Number of change records (journals) returned by the master as a result of a getChanges query by clone. Ideally the default batch size of 32 is sufficient as all changes are pulled in multiple batches as part of fetching. However if the setup needs a large batch size, execute the following command:</p> <pre>curl -k -u weblogic:password -H 'Content-Type: application/json' -X PUT 'https://oamadmin1-dcl.poc.com:7002/oam/services/rest/_replication/<replid>' -d '{"batchSize": "100", "replicaType": "SUPPLIER"}</pre>

Table 19-2 (Cont.) Modifying Replication Agreement Properties

Property	Modification Command
User Context	<p>In rare instances, the user context for replication poll may need to be modified.</p> <pre>curl -k -u weblogic:password -H 'Content-Type: application/json' -X PUT 'https://oamadmin1-dc1.poc.com:7002/oam/services/rest/_replication/201409231329353668' -d '{"replicaType":"CONSUMER", "config":{"entry":{"key":"authorization","value":"BASIC cG9sbHVzZXI6c2VjcmV0"}}}'</pre> <p>'cG9sbHVzZXI6c2VjcmV0' is a base 64 encoded value for polluser credentials. Any user credentials can be used here instead of the repluser which is used to execute the command.</p>

19.4 Customizing Transformation Rules

Transformation rules are used by APS.

The transformation rules illustrated in the following example are the default rules provided by Access Manager. A Clone can be configured to override these OOTB rules. This section documents how some of these rules can be modified and how to configure Access Manager to recognize these custom rules.

Default Transformation Rules

```
<?xml version="1.0" encoding="UTF-8"?>
<mdc-transform-rule>
  <changes-to-include entity-path="/policy"/>
  <changes-to-include
    entity-path="/config/NGAMConfiguration/DeployedComponent/Agent/WebGate/Instance">
    <replace attribute-match="*/PrimaryServerList/*/host" value-match="(.)">
      <replace-with
n="1">${/config/NGAMConfiguration/DeployedComponent/Server/NGAMServer/Profile/
OAMServerProfile/OAMSERVER/serverhost}</replace-with>
      </replace>
      <replace attribute-match="*/UserDefinedParameters/logoutRedirectUrl"
        value-match="(.)://(.):(.)oam/server/logout">
      <replace-with
n="1">${/config/NGAMConfiguration/DeployedComponent/Server/NGAMServer/Profile/
OAMServerProfile/OAMSERVER/serverprotocol}</replace-with>
      <replace-with
n="2">${/config/NGAMConfiguration/DeployedComponent/Server/NGAMServer/Profile/
OAMServerProfile/OAMSERVER/serverhost}</replace-with>
      <replace-with
n="3">${/config/NGAMConfiguration/DeployedComponent/Server/NGAMServer/Profile/
OAMServerProfile/OAMSERVER/serverport}</replace-with>
      </replace>
      <replace attribute-match="*/logoutRedirectUrl"
        value-match="(.)://(.):(.)oam/server/logout">
      <replace-with
n="1">${/config/NGAMConfiguration/DeployedComponent/Server/NGAMServer/Profile/
OAMServerProfile/OAMSERVER/serverprotocol}</replace-with>
      <replace-with
n="2">${/config/NGAMConfiguration/DeployedComponent/Server/NGAMServer/Profile/
OAMServerProfile/OAMSERVER/serverhost}</replace-with>
      <replace-with
n="3">${/config/NGAMConfiguration/DeployedComponent/Server/NGAMServer/Profile/
```

```

OAMServerProfile/OAMSERVER/serverport}</replace-with>
  </replace>
</changes-to-include>
<changes-to-include entity-path=
"/config/NGAMConfiguration/DeployedComponent/Server/NGAMServer/Profile/
AuthenticationModules"/>
<changes-to-include entity-path=
"/config/NGAMConfiguration/DeployedComponent/Server/NGAMServer/Profile/oamproxy"/>
<changes-to-include entity-path=
"/config/NGAMConfiguration/DeployedComponent/Server/NGAMServer/Profile/Sme/
SessionConfigurations"/>
<changes-to-include entity-path=
"/config/NGAMConfiguration/DeployedComponent/Server/NGAMServer/Profile/
OAMServerProfile/OAMSERVER">
<ignore attribute-match="/serverprotocol"/>
<ignore attribute-match="/serverhost"/>
<ignore attribute-match="/serverport"/>
</changes-to-include>
<changes-to-include entity-path="/config/NGAMConfiguration/DataCenterConfiguration/
Cluster">
<ignore attribute-match="/DataCenterType"/>
<ignore attribute-match="/ClusterId"/>
<ignore attribute-match="/WriteEnabledFlag"/>
</changes-to-include>
</mdc-transform-rule>

```

These transformation rules make changes to WebGate agent definitions. The following information details how you can modify these changes for the PrimaryServerList and logoutRedirectUrl attributes.

- PrimaryServerList updates the primary server list for all WebGate agents and replaces them with the Access Manager server host from the Clone environment. This change can be viewed in the oam-config.xml file; it replaces the value of the PrimaryServerList attribute with the value equal to \${DeployedComponent/Server/NGAMServer/Profile/OAMServerProfile/OAMSERVER/serverhost}; for example, oam1-lon.example.com. The limitation of this rule is that it updates all servers in the primary list.

You can use the transformation rule in the following example to update servers in PrimaryServerList with the different Clone servers.

```

<changes-to-include entity-path=
"/config/NGAMConfiguration/DeployedComponent/Agent/WebGate/Instance">
  <replace attribute-match="*/PrimaryServerList/0/host" value-match="(.)">
    <replace-with n="1">${"/config/NGAMConfiguration/DeployedComponent/
Server/NGAMServer/
Instance/oam_server1/host"}
  </replace-with>
  </replace>
  <replace attribute-match="*/PrimaryServerList/1/host" value-match="(.)">
    <replace-with n="1">${"/config/NGAMConfiguration/DeployedComponent/
Server/NGAMServer/
Instance/oam_server2/host"}
  </replace-with>
  </replace>
</changes-to-include>

```

Note: The OAM Managed Servers such as `oam_server1` and `oam_server2` must be updated with the names specified during deployment.

A load balancer is recommended between the WebGate and Access Manager server. In this case, you do not have to update the `PrimaryServerList` across data centers and can remove this transformation rule from the XML. However, you do need to update the `PrimaryServerList` parameter for `IAMSuiteAgent` and `accessgate-oic` unless you have configured these agents to communicate with the load balancer as well.

The following example illustrates how to change the transformation rule to update the `PrimaryServerList` only for `IAMSuiteAgent` and `accessgate-oic` agents and not WebGate agents.

```
<changes-to-include entity-path="/config/NGAMConfiguration/DeployedComponent/
Agent/WebGate/Instance">
  <replace attribute-match="/IAMSuiteAgent/PrimaryServerList/*/host" value-
match="(.)">
    <replace-with n="1">${"/config/NGAMConfiguration/DeployedComponent/
Server/NGAMServer/
Profile/OAMServerProfile/OAMSERVER/serverhost"}
  </replace-with>
</replace>
  <replace attribute-match="/accessgate-oic/PrimaryServerList/*/host" value-
match="(.)">
    <replace-with n="1">${"/config/NGAMConfiguration/DeployedComponent/
Server/NGAMServer/
Profile/OAMServerProfile/OAMSERVER/serverhost"}
  </replace-with>
</replace>
</changes-to-include>
```

- The `logoutRedirectUrl` attribute updates the logout URL protocol, host and port for all WebGate agents with respective values from the Clone. If a load balancer is used globally to define the logout URL for all WebGate agents in the Master environment, you don't need to replace the logout URL in the Clone environment and can remove the transformation rule. If you are using a DCC authentication scheme and a global load balancer host name to define the DCC login and logout URL, then again you don't need to replace the login and logout URL in the Clone environment and can remove the transformation rule.

To configure Access Manager to use custom transformation rules, update the `setDomainEnv.xml` file on the Clone machine. Each Clone can use different transformation rules. Be sure to restart the Clone's AdminServer after changing a transformation rule. [Figure 19-3](#) illustrates how to apply these custom rules.

Figure 19-3 Applying Custom Transformation Rules

```
#Added -Doracle.oam.EnableMDCReplication=true -Doracle.oam.MDCRuleFiles=/u01/bits/APS/TransformRules.xml below to enable APS configuration
EXTRA_JAVA_PROPERTIES=" -Doracle.oam.EnableMDCReplication=true -Doracle.oam.MDCRuleFiles=/u01/bits/APS/TransformRules.xml -DCONFIG_DS=jdbc/oamds -DCONF
G_HISTORY=true -Doam.oes.new=true -DOAM_POLICY_FILE=${DOMAIN_HOME}/config/fmwconfig/oam-policy.xml -DOAM_CONFIG_FILE=${DOMAIN_HOME}/config/fmwconfig/oa
m-config.xml -DOAM_ORACLE_HOME=${OAM_ORACLE_HOME} -Doracle.security.am.SERVER_INSTANCE_NAME=${SERVER_NAME} -Does.jars.home=${OAM_ORACLE_HOME}/server/lib
/oes-db -Does.integration.paths=${OAM_ORACLE_HOME}/server/lib/oeslib/oes-integration.jar -Does.enabled=true -Djavax.xml.soap.SOAPConnectionFactory=webl
ogic.wsee.saa.j.SOAPConnectionFactoryImpl -Djavax.xml.soap.MessageFactory=oracle.j2ee.ws.saa.j.soap.MessageFactoryImpl -Djavax.xml.soap.SOAPFactory=orac
le.j2ee.ws.saa.j.soap.SOAPFactoryImpl ${EXTRA_JAVA_PROPERTIES}"
export EXTRA_JAVA_PROPERTIES
```

19.5 Modifying a Rule Document

A rule document created for the purpose of replicating can be modified as required.

The allowed transformation rules are represented by the XML document in the following example:

```
<mdc-transform-rule>
<changes-to-include entity-path="/policy"/>
<changes-to-include entity-path="/oauth"/>
<changes-to-include entity-path="/IDM"/>
<changes-to-include
entity-path="/config/NGAMConfiguration/DeployedComponent/Agent/WebGate/Instance" />
<changes-to-include
entity-path="/config/NGAMConfiguration/DeployedComponent/Server/NGAMServer/Profile/
AuthenticationModules"/>
<changes-to-include
entity-path="/config/NGAMConfiguration/DeployedComponent/Server/NGAMServer/Profile/
oamproxy"/>
<changes-to-include
entity-path="/config/NGAMConfiguration/DeployedComponent/Server/NGAMServer/
Profile/Sme/SessionConfigurations"/>
<changes-to-include
entity-path="/config/NGAMConfiguration/DeployedComponent/Server/NGAMServer/Profile/
OAMServerProfile">
<ignore attribute-match="/OAMSERVER/serverprotocol"/>
<ignore attribute-match="/OAMSERVER/serverhost"/>
<ignore attribute-match="/OAMSERVER/serverport"/>
<ignore attribute-match="/OAMSERVER/serversslterminated"/>
<ignore attribute-match="/HostAlias/oamserverHttps/serverprotocol"/>
<ignore attribute-match="/HostAlias/oamserverHttps/serverhost"/>
<ignore attribute-match="/HostAlias/oamserverHttps/serverport"/>
</changes-to-include>
<changes-to-include
entity-path="/config/NGAMConfiguration/DeployedComponent/Server/NGAMServer/Profile/
OAMServerProfile/OAMSERVER">
<ignore attribute-match="/serverprotocol"/>
<ignore attribute-match="/serverhost"/>
<ignore attribute-match="/serverport"/>
<ignore attribute-match="/serversslterminated"/>
</changes-to-include>
<changes-to-include
entity-path="/config/NGAMConfiguration/DataCenterConfiguration/Cluster">
<ignore attribute-match="/DataCenterType"/>
<ignore attribute-match="/ClusterId"/>
<ignore attribute-match="/WriteEnabledFlag"/>
</changes-to-include>
<changes-to-include entity-path="/config/NGAMConfiguration/DeployedComponent/
Descriptors/OAMSEntityDescriptor" />
<changes-to-include entity-path="/config/NGAMConfiguration/DeployedComponent/
Federation/IdentityProvider" />
<changes-to-include entity-path="/config/NGAMConfiguration/DeployedComponent/
Federation/ServiceProvider" />
<changes-to-include entity-path="/config/NGAMConfiguration/DeployedComponent/Server/
NGAMServer/Profile/STS/fedattributeprofiles" />
<changes-to-include entity-path="/config/NGAMConfiguration/DeployedComponent/Server/
NGAMServer/Profile/STS/fedpartnerprofiles" />
<changes-to-include entity-path="/config/NGAMConfiguration/DeployedComponent/Server/
NGAMServer/Profile/STS/fedserverconfig" />
</mdc-transform-rule>
```

The rule document will mention the XPath of system configuration artifacts to be replicated for a clone. If there is any transformation to be done during replication for the entry in XPath, it can be provided as replacement rule for that clone. To add a new XPath for replication to a clone, create a new transformation XML file, using the above

XML document as a template. Add and remove XPath as required. For example, adding the following XPath as the child of an <mdc-transformation-rule> node and saving the file to the clone's file system will modify Available Services.

```
<changes-to-include entity-path=
  "/config/NGAMConfiguration/DeployedComponent/Descriptors/
  OAMSEntityDescriptor" />
```

Set the following VM property in the Clone's adminserver (setDomainEnv.sh) to use the newly created transformation rule document for replication instead of the OOTB one.

```
-Doracle.oam.MDCRuleFile=/path/to/rule/mdcrule.xml
```

For developer recommendations when using replication, see [Best Practices for Replication](#).

19.6 Using REST API for Replication Agreements

Use REST APIs provided by Access Manager to manage replication agreements.

This section describes the following topics:

- [Querying for Replication Agreement Details](#)
- [Creating a Replication Agreement](#)
- [Modifying a Replication Agreement](#)
- [Deleting a Replication Agreement](#)

19.6.1 Querying for Replication Agreement Details

Execute a REST request at the Master's endpoint to query the details of the Replication Agreement (including the polling interval) between a Master and a Clone data center.

1. If the replication agreement identifier is unknown, run the following command to list all the replication agreement identifiers, else skip this step.

```
curl -k -u weblogic:password 'https://supplier.example.com:7002/oam/services/
rest/_replication/agreements'
```

Sample output 1:

```
{"featureEnabled":"true","identifiers":"201411211137273612","ok":"true"}
```

Sample output 2:

```
{"featureEnabled":"true","identifiers":
["201411211137273612","201411211137273900"],"ok":"true"}
```

2. Query the details of a Clone data center's replication agreement (including the polling interval) as follows:

```
curl -k -u weblogic:password 'https://supplier.example.com:7002/oam/services/
rest/_replication/201409231329353668?type=consumer'
```

Sample output:

```
{"enabled":"true","identifier":"201409231329353668","ok":"true",
  "pollInterval":"60","startingSequenceNumber":"110","state":"READY"}
```

3. Query the details of a Master data center's replication agreement (including the polling interval) as follows:

```
curl -u weblogic:password 'https://supplier.example.com:7002/oam/services/rest/_replication/201409231329353668'
```

Sample output:

```
{"enabled": "true", "identifier": "201409231329353668", "lastSequenceNumber": "110", "ok": "true", "pollInterval": "3600", "startingSequenceNumber": "110", "state": "ACTIVE"}
```

Note: The poll interval of the Master data center's replication agreement does not affect the actual replication.

19.6.2 Modifying an Existing Replication Agreement

Replication Agreement properties (enabled status, poll interval and the like) can be updated by executing a REST request at the Master's endpoint. Either the Master or Clone Replication Agreement will be updated as specified by the value of the `replicaType` parameter.

The clone will poll for changes, apply them and wait the duration specified as the `pollInterval`.

```
PUT http://supplier.example.com/oam/services/rest/_replication/201312040602298762 HTTP/1.1
Content-Type: application/json
{"enabled": "false", "pollInterval": "60", "replicaType": "CONSUMER"}
```

This example will disable the Clone Replication Agreement and change the poll interval to '60' seconds. If a value for `replicaType` is not defined (or it is defined as `SUPPLIER`), the Master's Replication Agreement will be updated.

To edit the poll interval using cURL, use the following command. Note that the `replicaType` value for updating the clone in this case is `SUPPLIER` or `CONSUMER`.

```
curl -u <repluser> -H 'Content-Type: application/json' -X PUT
'https://supplier.example.com/oam/services/rest/_replication/201409231329353668'
-d '{"pollInterval": "60", "replicaType": "CONSUMER"}
```

Table 19-3 lists properties that can be modified using cURL and REST.

Table 19-3 Modifying Replication Agreement Properties

Property	Modification Command
BatchSize	<p>Number of change records (journals) returned by the master as a result of a <code>getChanges</code> query by clone. Ideally the default batch size of 32 is sufficient as all changes are pulled in multiple batches as part of fetching. However if the setup needs a large batch size, execute the following command:</p> <pre>curl -u <repluser> -H 'Content-Type: application/json' -X PUT 'https://master.example.com/oam/services/rest/_replication/<replid>' -d '{"batchSize": "100", "replicaType": "SUPPLIER"}</pre>

Table 19-3 (Cont.) Modifying Replication Agreement Properties

Property	Modification Command
User Context	<p>In rare instances, the user context for replication poll may need to be modified.</p> <pre>curl -u <repluser> -H 'Content-Type: application/json' -X PUT 'https://supplier.example.com:7002/oam/services/rest/_replication/ 201409231329353668' -d '{"replicaType":"CONSUMER", "config":{"entry":{"key":"authorization","value":" BASIC cG9sbHVzZXI6c2VjcmV0"}}}'</pre> <p>'cG9sbHVzZXI6c2VjcmV0' is a base 64 encoded value for polluser credentials. Any user credentials can be used here instead of the repluser which is used to execute the command.</p>

19.6.3 Deleting a Replication Agreement

A Replication Agreement can be deleted by executing the REST API at the Master data center's endpoint. Replication Agreements that are currently active and in use cannot be deleted until the Master and Clone have been disabled.

Disable the replication agreement before you remove it from on the Clone and Master data centers.

1. Disable the replication agreement on the Clone as follows:

```
curl -u <repluser> -H 'Content-Type: application/json' -X PUT
'https://supplier.example.com:7002/oam/services/rest/_replication/201409231
329353668' -d '{"enabled":"false","replicaType":"CONSUMER"}'
```

2. Disable the replication agreement on the Master as follows:

```
curl -u <repluser> -H 'Content-Type: application/json' -X PUT
'https://supplier.example.com:7002/oam/services/rest/_replication/201409231
329353668' -d '{"enabled":"false","replicaType":"SUPPLIER"}'
```

3. Delete the replication agreement as follows:

```
curl -u weblogic:welcome1 -H 'Content-Type: application/json' -X DELETE
'https://supplier.example.com:7002/oam/services/rest/_replication/201409231
329353668'
```

19.7 Replicating Domains in Identity Manager Deployments

If you have a deployment where Access Manager 11.1.2.1.0 and Oracle Identity Manager (11.1.2.1.0) are integrated in the same domain T2P cannot be used for domain replication because Identity Manager does not support it. In this case, Access Manager and Identity Manager need to be installed in different domains.

To replicate domains in Identity Manager deployments:

1. Install Access Manager.
2. Run `configureSecurityStore (-create)`.
3. Start Access Manager.

Remember to enable TRACE logging with instrumented EAR.

4. Install Identity Manager.
5. Run `configureSecurityStore (-join)`.
6. Update the default passwords for the Access Manager and Identity Manager domains in `DOMAIN_HOME/config/fmwconfig/default-keystore.jks` password using the `keytool` command.
7. Set the same password values in the CSF using the EM console.
 - a. Navigate to the `domain_name` of the appropriate Weblogic domain.
 - b. Right click the `domain_name` and navigate to Security --> Credentials.
 - c. Expand the `oracle.wsm.security` Credential map and edit the value of `keystore-csf-key`.
 - d. Update password and confirm password fields with the password.
This password should be same as the new password for `default-keystore.jks` in both Access Manager and Identity Manager domains
8. Map `oracle.wsm.security` with the Key `keystore-csf-key`.
9. Start Identity Manager.
10. Restart Access Manager and Identity Manager.

19.8 Best Practices for Replication

Here are some best practices to help you set up data replication.

The following points and the information in the sections should be taken into account when setting up data replication.

- It is recommended that as many Policy Domain artifacts are created as possible before cloning. This will help the replication manager work efficiently during incremental updates.
- The OAM server instance list will be used as the Well Known Addresses (WKA) to create a Coherence cluster so do not add other data center servers to the server instance list.
- To allow for a WebGate profile to point to a remote data center in the secondary server list, use the Other option to provide OAP with the host and port details of the remote data center.
- See [Enabling Replication Logs](#)
- See [Changing the User Identifier](#)

19.8.1 Enabling Replication Logs

To get detailed logs on replication agreement and replication poll-related issues, enable the logger 'oracle.oam.replication' by executing the WLST command.

```
setLogLevel(logger="oracle.oam.replication", level="TRACE:32", persist="0",
target="AdminServer")
```

This enables logger only till next shutdown of AdminServer. To keep the logger state across restart, set the persist attribute to "1".

19.8.2 Changing the User Identifier

While creating replication agreement if you have not specified any authorization header of the user to be used for replication if the user's password got changed at later point, you can edit the replication agreement with the latest user identity and password.

Run the following command:

```
curl -u <repluser> -H 'Content-Type: application/json' -X PUT
'https://supplier.example.com:7002/oam/services/rest/_replication/201409231
329353668' -d '{"replicaType":"CONSUMER","config":{"entry":
{"key":"authorization","value":"BASIC d2VibG9naWM6d2VsY29tZTE="}}}'
```

Setting Up the Multi-Data Center: A Sequence

The sequence of steps in this chapter will help you to setup a Multi-Data Center with four nodes using Oracle Access Manager 11.1.1.2. The configuration spans two Data Centers with two nodes per Data Center. The nodes are configured in Active/Active Mode.

This chapter contains the following section.

- [Before You Begin](#)
- [Setting Up a Multi-Data Center](#)
- [Enabling Automated Policy Synchronization](#)
- [Troubleshooting the Multi-Data Center Setup](#)

20.1 Before You Begin

Read the following chapters before beginning the steps documented in this sequence for an understanding of Multi-Data Center and its features.

- [Understanding Multi-Data Centers](#)
- [Configuring Multi-Data Centers](#)
- [Synchronizing Data In A Multi-Data Center](#)

Confirm the following before you begin the Multi-Data Center set-up sequence.

- Check that your operating system is up-to-date with all necessary patches applied.
- Mount the binaries you will be using. The applicable Oracle software includes:
 - Oracle Fusion Middleware Identity and Access Management 11g (11.1.2.3.0)
 - Oracle WebLogic Server 10g (10.3.6)
 - Oracle Database 11g (11.2.0.4)
 - Oracle Fusion Middleware Repository Creation Utility 11g (11.1.2.3.0)
- Add `/etc/hosts` entries on all four nodes being configured.
- Verify that the Oracle Database is connected and accessible.
- Verify that each machine has more than 30 GB space available and more than 8GB of memory available.

20.2 Setting Up a Multi-Data Center

For a successful set-up of a Multi-Data Center with data replication using T2P, the configuration spans two Data Centers with two nodes per Data Center. The nodes are configured in Active/Active Mode.

1. Install the Java Development Kit (JDK) 1.7.0.60 on all four of the Nodes and set the appropriate environment variables.
2. Run the Repository Creation Utility (RCU) 11.1.1.9.0 on Data Center 1 and Data Center 2.

This will create and load the appropriate database schemas for Oracle Identity and Access Management products.

3. Install WebLogic Server 10g (10.3.6) on Data Center 1, Node 1.

This process creates the Middleware Home (<MW_HOME>).

4. Install the Oracle Identity and Access Management 11g (11.1.2.3.0) software on Data Center 1, Node 1.

Oracle Identity and Access Management contains the Oracle Access Management suite which includes Oracle Access Manager. The default name of this Oracle product home directory after installation is Oracle_IDM1.

5. Run the Oracle Fusion Middleware Configuration Wizard script to configure Oracle Access Management on Data Center 1, Node 1.

The Wizard script is Oracle_IDM1/common/bin/config.sh script (on Linux or UNIX), or Oracle_IDM1\common\bin\config.cmd (on Windows). Minimally, you will be configuring:

- a new WebLogic domain
- an Oracle Access Management Administration Server
- an Oracle Access Management Managed Server
- Oracle Access Manager

6. Run the configureSecurityStore.py script on Data Center 1, Node 1 to configure the Database Security Store.

- a. <MW_HOME>/oracle_common/common/bin/wlst.sh
- b. <MW_HOME>/Oracle_IDM1/common/tools/configureSecurityStore.py -c IAM -d <MW_HOME>/user_projects/domains/OAMDomain -p Oracle123 -m create -v

7. Modify the following WebLogic scripts on Data Center 1, Node 1.

- a. Open startWeblogic.sh and startManagedWeblogic.sh using vi and enter the appropriate value for WLS_USER.

Enter the password when asked; do not hard code it here.

- b. Save startWeblogic.sh and startManagedWeblogic.sh.
- c. Open setDomainEnv.sh using vi and add the following line:

```
USER_MEM_ARGS="-Xms1024m -Xmx1024m -XX:MaxPermSize=512m"
```

d. Save `setDomainEnv.sh`.

8. Create and run a `cConfig.sh` script in the MDC folder on Data Center 1, Node 1.

The `cConfig.sh` script concatenates the necessary environment variables and `copyConfig.sh` into one script. You will need to create the MDC folder to serve as the `T2P_HOME`.

a. Add the following contents and save as `cConfig.sh`.

```
export JAVA_HOME=/u01/app/jdk1.7.0_60;
export MW_HOME=/u01/app/Middleware;
export T2P_HOME=/u01/bits/MDC;
export WL_DOMAIN_HOME=$MW_HOME/user_projects/domains/OAMDomain;
```

b. Source `cConfig.sh`.

```
$<>. cConfig.sh
```

9. Execute `copyBinary.sh` on Data Center 1, Node 1.

`copyBinary.sh` and `pasteBinary.sh` will be used to avoid a time-consuming installation process on the remaining nodes. When running `copyBinary.sh`, the Administration and Managed Servers can be running or stopped.

a. Change to the `bin` directory.

```
cd $MW_HOME/oracle_common/bin/;
```

b. Run the script.

```
./copyBinary.sh -javaHome $JAVA_HOME
-archiveLoc $T2P_HOME/oamt2pbin.jar -sourceMWHomeLoc $MW_HOME
-idw true -ipl $MW_HOME/oracle_common/oraInst.loc -silent true
-ldl $T2P_HOME/oam_cln_log
```

10. Copy the following files to the MDC folder on Data Center 1, Node 1.

- `$T2P_HOME/cConfig.sh` (already in the MDC folder)
- `$T2P_HOME/oamt2pbin.jar` (already in the MDC folder)
- `$MW_HOME/oracle_common/bin/pasteBinary.sh`
- `$MW_HOME/oracle_common/jlib/cloningclient.jar`
- `$MW_HOME/oracle_common/oraInst.loc`

11. Copy the MDC folder (populated with the five files) to Data Center 1, Node 2, and Data Center 2, Nodes 1 and 2.

12. Execute `pasteBinary.sh` on Data Center 1, Node 2.

a. Source `cConfig.sh`.

```
$<>. cConfig.sh
```

b. Run `pasteBinary.sh` on Data Center 1, Node 2.

```
$T2P_HOME/pasteBinary.sh -javaHome $JAVA_HOME
-al $T2P_HOME/oamt2pbin.jar -tmw $MW_HOME -silent true
```

```
-idw true -esp false -ipl $T2P_HOME/oraInst.loc
-ldl $T2P_HOME/oam_cln_log -silent true
```

13. Create a Managed Server JAR on Data Center 1, Node 1 and copy it to Data Center 1, Node 2.

`pack.sh` is used to create the JAR and is located in the `<MW_HOME>/oracle_common/common/bin` directory. The `pack` and `unpack` (used in the next step) scripts must be executed in the same Data Center only whereas `copyConfig` and `pasteConfig` (used later in the procedure) must be executed to the Master node of the other Data Center and then run `Pack/UnPack` within those data centers.

- a. Run `pack.sh`.

```
./pack.sh -domain=$MW_HOME/user_projects/domains/OAMDomain
-template=OAMManagedServer.jar -template_name="OAM Domain" -managed=true
```

- b. Copy `OAMManagedServer.jar` to the `MW_HOME/oracle_common/common/bin` directory on Data Center 1, Node 2.

14. Unpack the Managed Server JAR on Data Center 1, Node 2 using `unpack.sh`.

The JAR is used as a template to create the `OAMDomain` Domain Structure on Data Center 1, Node 2.

- a. `mkdir -p $MW_HOME/user_projects/domains/OAMDomain`

- b. `cd <MW_HOME>/oracle_common/common/bin`

- c. `./unpack.sh -domain=$MW_HOME/user_projects/domains/OAMDomain -template=OAMManagedServer.jar`

15. Modify the following WebLogic scripts on Data Center 1, Node 2.

- a. Open `startManagedWeblogic.sh` using `vi` and enter the appropriate values for `WLS_USER` and `WLS_PW`.

- b. Save `startWeblogic.sh` and `startManagedWeblogic.sh`.

- c. Open `setDomainEnv.sh` using `vi` and add the following line:

```
USER_MEM_ARGS="-Xms1024m -Xmx1024m -XX:MaxPermSize=512m"
```

- d. Save `setDomainEnv.sh`.

At this point in the sequence, the Data Center 1 cluster and its two nodes are configured and ready for Multi-Data Center configurations. Start the Administration Server and the `oam_server1` and `oam_server2` Managed Servers. Disable the SSL port number 14101.

16. Enable Multi-Data Center mode on Data Center 1, Node 1.

- a. `cd $T2P_HOME/MDC`

- b. Create `OAMMDC.properties` on Data Center 1, Node 1 using `vi`.

Add the following lines to `OAMMDC.properties` and save.

```
SessionMustBeAnchoredToDataCenterServicingUser=false
SessionDataRetrievalOnDemand=true
Reauthenticate=false
SessionDataRetrievalOnDemandMax_retry_attempts=3
```



```

SessionDataRetrievalOnDemandMax_conn_wait_time=80
SessionContinuationOnSyncFailure=true
MDCGitoCookieDomain=.customerpoc.com

```

- c. Change to the `../Oracle_IDM1/common/bin` directory and run WLST.
 - d. `./wlst.sh`
 - e. `connect()`
 - f. `domainRuntime()`
 - g. `enableMultiDataCentreMode(propfile="../OAMMDC.properties")`
 - h. `setMultiDataCentreClusterName(clusterName="<string_value>")`
 - i. `setMultiDataCenterWrite(WriteEnabledFlag="true")`
 - j. `validateMDCCConfig()`
 - k. `exit()`
17. Create `oamt2pconfig.jar` on Data Center 1, Node 1 and copy it to Data Center 2, Node 1.

`copyConfig.sh` is located in `$MW_HOME/oracle_common/bin/` and must be executed on the Master node. To run `copyConfig.sh`, the Administration and Managed Servers should be up and running.

- a. Source `cConfig.sh`.

```
$>. cConfig.sh
```
 - b. Create `$T2P_HOME/t2p_domain_pass.txt` using `vi`.

Add a password value for use with `copyConfig.sh`; for example, `Oracle123` (without quotes).
 - c. `./copyConfig.sh -javaHome $JAVA_HOME -archiveLoc $T2P_HOME/oamt2pConfig.jar -sourceDomainLoc $WL_DOMAIN_HOME -sourceMWHomeLoc $MW_HOME -domainHostName oam1-dc1.customerpoc.com -domainPortNum 7001 -domainAdminUserName weblogic -domainAdminPassword $T2P_HOME/t2p_domain_pass.txt -silent true -ldl $T2P_HOME/oam_cln_log_config -opssDataExport true -debug true`
 - d. Copy `oamt2pconfig.jar` to the Data Center 2, Node 1.
18. Execute `pasteBinary.sh` on Data Center 2, Node 1.
- a. Source `cConfig.sh`.

```
$>. cConfig.sh
```
 - b. Run:

```
$T2P_HOME/pasteBinary.sh -javaHome $JAVA_HOME -al $T2P_HOME/oamt2pbin.jar -tmw $MW_HOME -silent true -idw
```

```
true -esp false -ipl $T2P_HOME/oraInst.loc -ldl
$T2P_HOME/oam_cln_log -silent true
```

19. Execute pasteBinary.sh on Data Center 2, Node 2.

a. Source cConfig.sh.

```
$<>. cConfig.sh
```

b. Run:

```
$T2P_HOME/pasteBinary.sh -javaHome $JAVA_HOME -al
$T2P_HOME/oamt2pbin.jar -tmw $MW_HOME -silent true -idw
true -esp false -ipl $T2P_HOME/oraInst.loc -ldl
$T2P_HOME/oam_cln_log -silent true
```

20. Execute extractmovePlan.sh on Data Center 2, Node 1.

a. mkdir \$T2P_HOME/moveplan

b. cd \$MW_HOME/oracle_common/bin/

c. Source cConfig.sh.

```
$<>. cConfig.sh
```

d. ./extractMovePlan.sh -javaHome \$JAVA_HOME -al \$T2P_HOME/oamt2pConfig.jar -planDirLoc \$T2P_HOME/moveplan/

e. Backup the moveplan and then make the following modifications using vi.

Search and Replace the hostnames

```
:1,$s/oam1-dc1/oam1-dc2/g
:1,$s/oam2-dc1/oam2-dc2/g
```

Search and replace datasource names

```
:1,$s/DC1/DC2/g
```

Search for the two instances of "Password File" and add the previously created t2p_domain_pass.txt Password File location as a <value>.

```
<value>/u01/bits/final/MDC/t2p_domain_pass.txt</value>
```

f. Create \$T2P_HOME/t2p_pass.txt with a password value you want.

This file is used to create new components on the target environment with the associated password. The moveplan has a reference to it so that when the components are created the password will be assigned.

21. Execute pasteConfig.sh on Data Center 2, Node 1.

The same JDK used on the source must be used on the target.

```
$MW_HOME/oracle_common/bin/pasteConfig.sh -javaHome
$JAVA_HOME -archiveLoc $T2P_HOME/oamt2pConfig.jar -
targetMWHomeLoc $MW_HOME -targetDomainLoc $WL_DOMAIN_HOME -
movePlanLoc $T2P_HOME/moveplan/moveplan.xml -
domainAdminPassword $T2P_HOME/t2p_domain_pass.txt -ldl
$T2P_HOME/oam_cln_log -silent true
```

Note:

Comment out all keystore <> tags in the moveplan if there is an issue.

22. Modify the following WebLogic scripts on Data Center 2, Node 1.
 - a. Open `startWeblogic.sh` and `startManagedWeblogic.sh` using `vi` and enter the appropriate values for `WLS_USER` and `WLS_PW`.
 - b. Save `startWeblogic.sh` and `startManagedWeblogic.sh`.
 - c. Open `setDomainEnv.sh` using `vi` and add the following line:

```
USER_MEM_ARGS="-Xms1024m -Xmx1024m -XX:MaxPermSize=512m"
```
 - d. Save `setDomainEnv.sh`.
23. Create a Managed Server JAR on Data Center 2, Node 1 and copy it to Data Center 2, Node 2.

`pack.sh` is used to create the JAR and is located in the `<MW_HOME>/oracle_common/common/bin` directory. The `pack` and `unpack` (used in the next step) scripts must be executed in the same Data Center only.

- a. Run `pack.sh`.

```
./pack.sh -domain=$MW_HOME/user_projects/domains/OAMDomain
-template=OAMManagedServer.jar -template_name="OAM Domain" -managed=true
```
 - b. Copy `OAMManagedServer.jar` to the `<MW_HOME>/oracle_common/common/bin` directory on Data Center 2, Node 2.
24. Unpack the Managed Server JAR on Data Center 2, Node 2 using `unpack.sh`.
The JAR will be used as a template to create the OAMDomain Domain Structure on Data Center 2, Node 2.
 - a. `mkdir -p $MW_HOME/user_projects/domains/OAMDomain`
 - b. `cd <MW_HOME>/oracle_common/common/bin`
 - c. `./unpack.sh -domain=$MW_HOME/user_projects/domains/OAMDomain -template=OAMManagedServer.jar`
 25. Modify the following WebLogic scripts on Data Center 2, Node 2.
 - a. Open `startManagedWeblogic.sh` using `vi` and enter the appropriate values for `WLS_USER` and `WLS_PW`.
 - b. Save `startWeblogic.sh` and `startManagedWeblogic.sh`.
 - c. Open `setDomainEnv.sh` using `vi` and add the following line:

```
USER_MEM_ARGS="-Xms1024m -Xmx1024m -XX:MaxPermSize=512m"
```
 - d. Save `setDomainEnv.sh`.

At this point in the sequence, the Data Center 2 cluster and its two nodes are configured and ready for Multi-Data Center configurations. Start the Administration Server and the `oam_server1` and `oam_server2` Managed Servers. Disable the SSL port number 14101.

26. Enable Multi-Data Center mode on Data Center 2, Node 1.
 - a. Restart the Administration Server on Data Center 2, Node 1.
 - b. Change to the ../Oracle_IDM1/common/bin directory and run WLST.
 - c. `./wlst.sh`
 - d. `connect()`
 - e. `domainRuntime()`
 - f. `enableMultiDataCentreMode(propfile="//OAMMDC.properties")`
 - g. `setMultiDataCentreClusterName(clusterName="<string_value>")`
 - h. `setMultiDataCenterWrite(WriteEnabledFlag="true")`
 - i. `exit()`
27. Create two WebGate agents using the Oracle Access Management Console on Data Center 1, Node 1 only.
 - Name the agents MDC-DC1 and MDC-DC2
 - Check `AccessClientPassword` and `AllowManagementOperations`
 - Be sure the Primary Server List has Access Server listed as "Other" - ideally it will have global load balancer/LTM entries rather than the local hosts entries.
28. Create the `MDCPartner-DC1` and `MDCPartner-DC2` property files using `vi`
Create these files on both Data Center 1, Node 1 and Data Center 2, Node 1 with the following data.

```
vi MDCPartner-DC1.properties

remoteDataCentreClusterId=FINALDC1
oamMdcAgentId=MDC-DC1
PrimaryHostPort=oam1-dc1.poc.com:5575
SecondaryHostPort
AccessClientPasswd
oamMdcSecurityMode=Open
agentVersion=11g
trustStorePath
keyStorePath
globalPassPhrase
keystorePassword
RESTEndpoint=http://oam1-dc1.poc.com:7001

vi MDCPartner-DC2.properties

remoteDataCentreClusterId=FINALDC2
oamMdcAgentId=MDC-DC2
PrimaryHostPort=oam1-dc2.poc.com:5575
SecondaryHostPort
AccessClientPasswd
oamMdcSecurityMode=Open
agentVersion=11g
trustStorePath
keyStorePath
```

```
globalPassPhrase
keystorePassword
RESTEndpoint=http://oam1-dc2.poc.com:7001
```

29. Register the partners on Data Center 1, Node 1 using `wlst.sh`.
 - a. Change to the `../Oracle_IDM1/common/bin` directory and run WLST.
 - b. `./wlst.sh`
 - c. `connect()`
 - d. `domainRuntime()`
 - e. `addPartnerForMultiDataCentre(propfile="../MDCPartner-DC1.properties")`
 - f. `addPartnerForMultiDataCentre(propfile="../MDCPartner-DC2.properties")`
 - g. `setMultiDataCenterType(DataCenterType="Master")`
 - h. `exit()`
30. Register the partners on Data Center 2, Node 1 using `wlst.sh`.
 - a. Change to the `../Oracle_IDM1/common/bin` directory and run WLST.
 - b. `./wlst.sh`
 - c. `connect()`
 - d. `domainRuntime()`
 - e. `addPartnerForMultiDataCentre(propfile="../MDCPartner-DC1.properties")`
 - f. `addPartnerForMultiDataCentre(propfile="../MDCPartner-DC2.properties")`
 - g. `setMultiDataCenterType(DataCenterType="Clone")`
 - h. `exit()`
31. Export the partner and policy information from Data Center 1, Node 1 and then import it to Data Center 2, Node 1.
 - a. Change to the `../Oracle_IDM1/common/bin` directory and run WLST to export from Data Center 1, Node 1.
 - b. `./wlst.sh`
 - c. `connect()`
 - d. `exportAccessStore(toFile="<name and location of ZIP file>", namePath="/")`
 - e. `exit()`
 - f. Copy the binary file (that is, *<name and location of ZIP file>*) to Data Center 2, Node 1.

- g. Change to the `../Oracle_IDM1/common/bin` directory and run WLST to import on Data Center 2, Node 1.
- h. `./wlst.sh`
- i. `connect()`
- j. `importAccessStore(fromFile="<name and location of ZIP file>", namePath="/")`
- k. `exit()`

20.3 Enabling Automated Policy Synchronization

Enabling the Automated Policy Synchronization (APS) feature for automated data synchronization among the servers includes commands for testing the REST services as well as details on adding custom transformation rules to the synchronization.

See [Synchronizing Data In A Multi-Data Center](#) for details on APS and transformation rules.

1. Stop all the Administration and Managed Servers.
2. Add the following line to `$WL_DOMAIN_HOME/bin/setDomainEnv.sh` on both Data Center 1, Node 1 and Data Center 2, Node 1 and save the file.

```
EXTRA_JAVA_PROPERTIES=" -
Doracle.oam.EnableMDCReplication=true -DCONFIG_DS=jdbc/oamds
...
```

3. Start the Administration Servers only.
4. Test the REST services using the following commands:

```
curl -u weblogic 'http://oam1-dc1.customerpoc.com:7001/oam/services/rest/_replication/hello'
```

```
RESPONSE: {"ok":"true"}
```

```
curl -u weblogic 'http://oam1-dc2.poc.com:7001/oam/services/rest/_replication/hello'
```

```
RESPONSE: {"ok":"true"}
```

```
curl -u weblogic:Oracle123 -H 'Content-Type: application/json' -X POST 'http://oam1-dc1.poc.com:7001/oam/services/rest/_replication/setup' -d '{"name":"DC1toDC2", "source":"FINALDC1","target":"FINALDC2","documentType":"ENTITY"}'
```

```
RESPONSE:
```

```
{"enabled":"true","identifier":"201409040157218184","ok":"true","pollInterval":"900","startingSequenceNumber":"101","state":"READY"}
```

#The random long number will be unique to every replication agreement, so don't use that number as is, though use the number which comes as an output from the 3rd curl command below

```
curl -u weblogic:Oracle123 -H 'Content-Type: application/json' 'http://oam1-dc1.poc.com:7001/oam/services/rest/_replication/201409040157218184'
```

```
RESPONSE:
```

```
{"enabled":"true","identifier":"201409040157218184","ok":"true","pollInterval":"3600","startingSequenceNumber":"101","state":"ACTIVE"}
```

```
curl -u weblogic:Oracle123 -H 'Content-Type: application/json' 'http://oam1-dc1.poc.com:7001/oam/services/rest/_replication/201409040157218184?type=consumer'
```

RESPONSE:

```
{"enabled":"true","identifier":"201409040157218184","ok":"true","pollInterval":"900","startingSequenceNumber":"101","state":"READY"}
```

```
curl -u weblogic:Oracle123 -H 'Content-Type: application/json' -X PUT 'http://oam1-dc1.poc.com:7001/oam/services/rest/_replication/201409040157218184' -d '{"pollInterval":"60","replicaType":"consumer"}
```

RESPONSE:

```
{"enabled":"true","identifier":"201409040157218184","ok":"true","pollInterval":"3600","startingSequenceNumber":"101","state":"ACTIVE"}
```

#Run this command on NODE1DC2 ONLY IF you want to disable Policy Writes to DC2 (or Clones) and just accept policy writes via the Master Policy Server using APS Synch: setMultiDataCenterWrite(WriteEnabledFlag="false")

5. Create a transformation rules file using vi as \$T2P_HOME/transformationrules.xml.

transformationrules.xml should contain the following content.

```
<?xml version="1.0" encoding="UTF-8"?><mdc-transform-rule> <changes-to-include entity-path="/DeployedComponent/Agent/WebGate/Instance"> <replace attribute-match="/IAMSuiteAgent/PrimaryServerList/*/host" value-match="(.*)"> <replace-with n="1">${DeployedComponent/Server/NGAMServer/Profile/OAMServerProfile/OAMSERVER/serverhost}</replace-with </changes-to-include> <changes-to-include entity-path="/DeployedComponent/Server/NGAMServer/Profile/AuthenticationModules"/></mdc-transform-rule>
```

6. Add the following line to \$WL_DOMAIN_HOME/bin/setDomainEnv.sh on Data Center 2, Node 1 only and save the file.

```
EXTRA_JAVA_PROPERTIES=" -Doracle.oam.MDCRuleFile=/u01/bits/customer/MDC/transformationrules.xml -Doracle.oam.EnableMDCReplication=true -DCONFIG_DS=jdbc/oamds ...
```

7. Start the Administration and Managed Servers.

This completes the Multi-Data Center setup with T2P data replication and APS configuration! You can test the APS function by creating an agent and a policy on data Center 1 and verifying that it auto migrates to Data Center 2.

20.4 Troubleshooting the Multi-Data Center Setup

If you have identified inconsistencies or errors in your setup and want to revert the APS, follow this procedure.

1. Disable replication on the Master (Supplier).

```
curl -u weblogic:welcome1 -H 'Content-Type: application/json' -X PUT 'http://supplier.example.com:7001/oam/services/rest/_replication/201311271226476658' -d '{"enabled":"false","replicaType":"SUPPLIER"}
```

2. Disable replication on the Clone (Consumer).

```
curl -u weblogic:welcome1 -H 'Content-Type: application/json'
-X PUT 'http://supplier.example.com:7001/oam/services/rest/
_replication/201311271226476658' -d
'{"enabled": "false", "replicaType": "CONSUMER"}'
```

3. Delete the replication agreements on the Master and Clone using this command.

```
curl -u weblogic:welcome1 -H 'Content-Type: application/json'
-X DELETE 'http://supplier.example.com:7001/oam/services/
rest/_replication/201311271226476658'
```

Note:

The AM_REPLICATION_SETTINGS table in the OAM Schema defines the replication agreements so you can also delete the agreements by manual deletion using the following SQL statement.

- Select * from FINALDC1_OAM.AM_REPLICATION_SETTINGS;
- Select * from FINALDC2_OAM.AM_REPLICATION_SETTINGS;

Alternately:

- Delete from FINALDC1_OAM.AM_REPLICATION_SETTINGS;
 - Delete from FINALDC2_OAM.AM_REPLICATION_SETTINGS;
-
-

4. commit;

Part VI

Managing Access Manager SSO, Policies, and Testing

Administrators manage single-sign on (SSO) with Access Manager, configure Access Manager policies, test connectivity and policies, and configure centralized session logout.

Testing your single sign-on connection and policies is also described. This section contains the following chapters:

- [Understanding Single Sign-On with Access Manager](#)
- [Managing Authentication and Shared Policy Components](#)
- [Understanding Credential Collection and Login](#)
- [Using Password Policy](#)
- [Managing Policies to Protect Resources and Enable SSO](#)
- [Validating Connectivity and Policies Using the Access Tester](#)
- [Configuring Centralized Logout for Sessions Involving 11g WebGates](#)

Understanding Single Sign-On with Access Manager

You can familiarize yourself with the elements that comprise Access Manager single sign-on (SSO). A SSO provides an administrator with the foundation to begin developing policies.

The following topics provide information about:

- [Access Manager Single Sign-On Components](#)
- [Access Manager Policy Model](#)
- [Anatomy of an Application Domain and Policies](#)
- [Policy Conditions and Rules](#)
- [Understanding SSO Cookies](#)
- [Configuring Single Sign-On with Access Manager](#)

Note:

Unless explicitly stated, information in this chapter is the same for all agent types and Access Manager credential collectors.

See [Introduction to Centralized Logout for Access Manager 11g](#).

21.1 Access Manager Single Sign-On Components

Login is the action a user takes to authenticate and gain access to a protected application. Single sign-on (SSO) is the process that gives users the ability to access multiple protected resources (Web pages and applications) with a single authentication. SSO is enabled by Access Manager to eliminate the need for additional or different logins to access other applications at the same (or lower) authentication level during the same session.

Access Manager converges several SSO architectures (including Identity Federation for Partner Networks, and Service Oriented Architecture) and provides SSO through a common SSO Engine for consistent service across multiple protocols. The Oracle Identity Management Infrastructure stores user identities in the identity store referenced in the policy.

Note:

Contextual data is the information that is presented to or collected by Access Manager at various stages of user interaction. These stages include authentication, authorization, enterprise SSO, federation, adaptive authentication, token validation, session creation, and so on. The information itself might comprise a user's device fingerprints, IP address, antivirus and firewall protection, assertion and so on. Components that play the role of contextual data providers and asserters when integrated with Access Manager include Enterprise Single Sign-on, Identity Federation, Oracle Adaptive Access Manager.

[Table 21-1](#) summarizes the components that support or enforce Access Manager policies, and where to find more information about these, if needed.

Note:

Default Access Manager behavior is to deny access when a resource is not protected by a policy that explicitly allows access. To delegate authentication tasks to Access Manager, agents must reside with the relying parties and must be registered with Access Manager. Registering an agent sets up the required trust mechanism between the agent and Access Manager SSO.

Table 21-1 Summary: SSO Components

Component	Description
Applications	<p>Applications can delegate authentication and authorization to Access Manager and accepts headers from a registered Agent.</p> <p>Note: External applications do not delegate authentication. Instead, these display HTML login forms that ask for application user names and passwords. For example, Yahoo! Mail is an external application that uses HTML login forms.</p>
<ul style="list-style-type: none"> OAM Server Oracle Access Management Console (installed on WebLogic AdminServer) 	<p>Non-administrative users first gain access by entering the URL of a protected resource, which returns the SSO login page.</p> <p>See Also: "Understanding Credential Collection and Login".</p> <p>Administrative users access the console to author policies by typing the URL: <code>https://host:port/oamconsole</code>. Although, default policies can be generated automatically during Agent registration, as described in Registering and Managing OAM 11g Agents.</p> <p>See Also: Managing Policies to Protect Resources and Enable SSO.</p>
Policy Enforcement Agents	<ul style="list-style-type: none"> OAM Agents (Webgate or Access Client) Legacy OSSO Agents Legacy OpenSSO Agents <p>See Also: Introduction to Agents and Registration.</p>
Credential Collectors and Communication Channels	<ul style="list-style-type: none"> Authentication with the default embedded credential collector (ECC) occurs across the HTTP (HTTPS) channel Authentication with the optional detached credential collector (DCC) occurs across the Oracle Access Protocol (OAP) channel Authorization occurs across the Oracle Access Protocol (OAP) channel <p>See Also: Table 22-5</p>

Table 21-1 (Cont.) Summary: SSO Components

Component	Description
SSO Engine	Manages the session lifecycle, facilitates global logout across all relying parties in the valid session, and provides consistent service across multiple protocols. See Also: Maintaining Access Manager Sessions and Configuring Centralized Logout for Sessions Involving 11g WebGates
Proxy support for legacy systems	<ul style="list-style-type: none"> OAM Proxy supports legacy Access Manager implementations by acting as a legacy Access Server. See: <ul style="list-style-type: none"> "Managing the Access Protocol for OAM Proxy Simple and Cert Mode Security" "OAM Proxy Metrics and Tuning" OSSO Proxy supports OSSO Agents by acting as the legacy OSSO Server. See: Registering and Managing Legacy OSSO Agents Oracle-provided OpenSSO Proxy handles requests for resources protected by OpenSSO Agents. See: Registering and Managing Legacy OpenSSO Agents See Also: About the Embedded Proxy Server and Backward Compatibility
Access Policies	Registered agents rely on Access Manager authentication, authorization, and token issuance policies to determine who gets access to protected applications (defined resources). Note: Default Access Manager behavior is to deny access when a resource is not protected by a policy that explicitly allows access. See Also: Managing Policies to Protect Resources and Enable SSO
Policy Store	Database in production environments (otherwise, oam-config.xml). See Also: Managing Data Sources
Cryptographic keys and Key Storage	One key is generated and used per registered mod_osso or 11g Webgate. However, one single key is generated for all 10g Webgates. See Also: Table 1-2 .
Cookies	See: " Understanding SSO Cookies ".

Note:

Single Sign-on for the Oracle Access Management Console, and other Oracle Identity Management consoles deployed in a WebLogic container, is enabled using the pre-registered IAMSuiteAgent and companion policies. No further configuration is needed to protect the consoles.

Single sign-on can be implemented as introduced in [Table 21-2](#), which includes pointers to additional information.

Table 21-2 Introduction to SSO Implementations

SSO Type	Description
Single Network Domain SSO	You can set up Access Manager single sign-on for resources within a single network domain (<i>example.com</i> , for example). This includes protecting resources belonging to multiple WebLogic administration domains within a single network domain. Single Network Domain SSO is the subject of this book.
Multiple Network Domain SSO	Access Manager 11g supports cross-network-domain single sign-on out of the box. See Also: " Multiple Network Domain SSO ".
Application SSO	Application single sign-on allows users who have been authenticated by Access Manager to access applications without being re-authenticated. See Also: " Application SSO and Access Manager "
Multiple WebLogic Server Domain SSO	The basic administration unit for WebLogic Server instances is known as a domain. You can define multiple WebLogic administration domains based on different system Administrators' responsibilities, application boundaries, or the geographical locations of WebLogic servers. However, all Managed Servers in a cluster must reside in the same WebLogic Server domain. See Also: " Multiple WebLogic Server Domain SSO "
Reverse-Proxy SSO	This SSO implementation type is supported with a few configuration differences. See Also: " Reverse-Proxy SSO "
SSO with Mixed Release Agents	Access Manager seamlessly supports registered 11g and 10g OAM agents (Webgates and programmatic access clients), as well as legacy OSSO Agents (<code>mod_osso 10g</code>), and legacy OpenSSO agents). These can be used in any combination.

21.1.1 Multiple Network Domain SSO

With Access Manager, this is a standard feature. When 11g WebGates are used exclusively all cookies in the system are host-based. However, you must have control over all the domains. If some domains are controlled by external entities (not part of the Access Manager deployment), Oracle recommends that you use Identity Federation.

Access Manager supports cross-network-domain single sign-on out of the box. During single sign-off with Access Manager:

- The SSO cookie set by OAM Server is a host cookie that works across the network domains. The WebGate clears its standalone Agent cookie and then redirects to the OAM Server for session clearing.
- 10g WebGates do not have a standalone Agent cookie; logout occurs only on the server side with no redirection required.

- With 11g WebGates and OSSO agents that support a standalone agent cookie, the agent Logout Callback URL is called in parallel. The agents accessed in a session and agents from multiple domains are all called in parallel, depending on the number of concurrent connections supported in the browser.

Note:

Access Manager provides a proprietary multiple network domain SSO capability that predates Identity Federation 11.1.1. If this is implemented in your Oracle Access Manager 10g deployment, you can register 10g Agents with Access Manager 11g to continue this support.

See Also:

- ["Configuring Centralized Logout for 11g WebGates"](#)
 - , 11.1.1
-
-

21.1.2 Application SSO and Access Manager

Access Manager enables Administrators to create a web of trust in which a user's credentials are verified once and are provided to each application the user runs. Using these credentials, the application does not need to re-authenticate the user with its own mechanism. Application single sign-on allows users who have been authenticated by Access Manager to access applications without being re-authenticated.

There are two ways to send a user's credentials:

- **Using Cookies:** A specific value is set on the browser's cookie that the application must extract to identify a user.
- **Using Header Variables:** An HTTP header set on the request by the agent and visible to the application.

Note:

Both forms require Administrators to enter the appropriate responses within the policy. For more information, see "[Introduction to Policy Responses for SSO](#)".

Header response values are inserted into a request by an OAM Agent, and can only be applied on Web servers that are protected by an agent. registered with Access Manager 11g If the policy includes a redirect URL that is hosted by a Web server not protected by Access Manager, header responses are not applied.

For example, when a user authenticates, she might be redirected to a portal index page:

`http://example.com/authnsuccess.htm`

For authentication failure, an authentication action might redirect the user to an error page or a self-registration script:

<http://example.com/authnfail.htm>

21.1.3 Multiple WebLogic Server Domain SSO

Access Manager supports SSO in multiple WebLogic administration domains. You can define multiple WebLogic administration domains based on different system Administrators' responsibilities, application boundaries, or the geographical locations of WebLogic servers.

Conversely, you can use a single domain to centralize all WebLogic Server administration activities.

Note:

All Managed Servers in a cluster must reside in the same domain; you cannot split a cluster over multiple domains. All Managed Servers in a domain must run the same version of the Oracle WebLogic Server software. The Administration Server can run either the same version as the Managed Servers in the domain, or a later service pack.

There are two basic types of WebLogic administration domains:

- **Domain with Managed Servers:** A simple production environment can consist of a domain with several Managed Servers that host applications, and an Administration Server to perform management operations. In this configuration, applications and resources are deployed to individual Managed Servers; similarly, clients that access the application connect to an individual Managed Server.

Production environments that require increased application performance, throughput, or availability may configure two or more of Managed Servers as a cluster. Clustering allows multiple Managed Servers to operate as a single unit to host applications and resources. For more information about the difference between a standalone and clustered Managed Servers, see Managed Servers and Clustered Managed Servers.
- **Standalone WebLogic Server Domain:** For development or test environments, you may want to deploy a single application and server independently from servers in a production domain. In this case, you can deploy a simple domain consisting of a single server instance that acts as an Administration Server and also hosts the applications you are developing. The examples domain that you can install with WebLogic Server is an example of a standalone WebLogic Server domain.

All Managed Servers in a cluster must reside in the same domain; you cannot split a cluster over multiple domains. All Managed Servers in a domain must run the same version of the Oracle WebLogic Server software. The Administration Server can run either the same version as the Managed Servers in the domain, or a later service pack.

Each domain's configuration is stored in a separate configuration file (config.xml), which is stored on the Administration Server along with other files such as logs and security files. When you use the Administration Server to perform a configuration task, the changes you make apply only to the domain managed by that Administration Server. To manage another domain, use the Administration Server for that domain. For this reason, the servers instances, applications, and resources in one domain should be treated as being independent of servers, applications, and resources in a

different domain. You cannot perform configuration or deployment tasks in multiple domains at the same time.

Each domain requires its own Administration Server for performing management activities. When you use the Oracle Access Management Console to perform management and monitoring tasks, you can switch back and forth between domains, but in doing so, you are connecting to different Administration Servers.

If you have created multiple domains, each domain must reference its own database schema. You cannot share a configured resource or subsystem between domains. For example, if you create a JDBC data source in one domain, you cannot use it with a Managed Server or cluster in another domain. Instead, you must create a similar data source in the second domain. Furthermore, two or more system resources cannot have the same name.

21.1.4 Reverse-Proxy SSO

Reverse-Proxy SSO is a supported configuration.

Following are certain caveats associated with this configuration:

Caveats

If you are going to use a reverse proxy in a single sign-on configuration, be sure to perform one of the following tasks. Otherwise, the reverse proxy hides the client's IP address:

- Either to set the `IPvalidation` parameter to `false`
- Or add the proxy IP address to the `IPValidationExceptions` list in the Webgate registration

In some situations the Reverse Proxy does not pass the 10g Webgate `ObSSOCookie` to Oracle WebLogic after a successful authentication. To avoid this issue:

- Use Form authentication instead of Basic Over LDAP when using Reverse Proxy with Oracle WebLogic
- For 11g Webgate, a user-defined parameter (`filterOAMAuthnCookie` (default `true`)) can be used to prevent the `OAMAuthnCookie` from being passed to downstream applications for security consideration. If you do want to pass the cookie on, then set the `filterOAMAuthnCookie` parameter to `false`.

21.2 Access Manager Policy Model

Access Manager distills the policy models of Oracle Access Manager and OSSO into a single Access Manager policy model.

[Figure 21-1](#) illustrates the main elements of the Access Manager 11g policy model including the shared policy components, an individual Application Domain, and external dependencies.

Figure 21-1 Access Manager 11g Policy Model

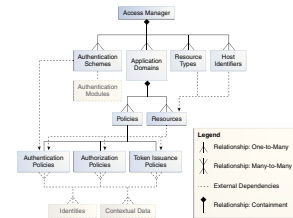

Shared Policy Components

Shared policy components are global and can be used in one or more Application Domains. [Figure 21-2](#) illustrates the shared components for Access Manager policies.

Figure 21-2 Access Manager Shared Policy Components

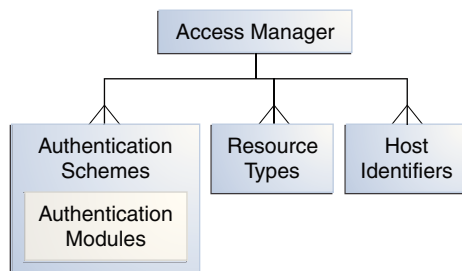

[Table 21-3](#) describes the global, shared components in an Access Manager policy.

Table 21-3 Access Manager Global, Shared Policy Components

Component	Description
Resource Types	<p>Defines the type of resource to be protected and the associated operations. The default resource type is HTTP. However, Administrators can define non-HTTP resource types that can be applied to specific resources in an Application Domain.</p> <p>Any number of resources can belong to a specific resource type. However, each resource that is added to a policy must be defined as a single type:</p> <ul style="list-style-type: none"> • HTTP • wl_authen • TokenServiceRP <p>See Also:</p> <ul style="list-style-type: none"> • Managing Authentication and Shared Policy Components : Managing Resource Types • Managing Templates, Endpoints, and Policies: Managing TokenServiceRP Type Resources
Host Identifiers	<p>A host can be known by multiple names. To ensure that OAM recognizes the URL for a resource, OAM must know the various ways used to refer to that resource's host computer.</p> <p>With Access Manager, all possible host variations are stored together. Administrators enter the canonical name for the host and every other name by which the host can be addressed by users. A request sent to any address on the list is mapped to the official host name.</p> <p>Authentication and authorization policies in an Application Domain protect resources based on host identifiers. Host identifiers are used to identify resources or an application at run time and can be used to formulate policies for application resources at design time.</p> <p>Host identifiers can be generated automatically during Agent registration and are used to seed the Resource definition and default authentication and authorization policies in the new Application Domain.</p> <p>Alternatively: Administrators can create a host identifier definition for use in one or more Application Domains.</p> <p>Virtual Web Hosting: Enables support of multiple domain names and IP addresses that each resolve to their unique subdirectories on a single server. The same host can have multiple sites being served either based on multiple NIC cards (IP based) or multiple names (for example, abc.com and def.com) resolving to same IP.</p> <p>See Also: "About Host Identifiers".</p>

Table 21-3 (Cont.) Access Manager Global, Shared Policy Components

Component	Description
Authentication Scheme	<p>A named component that defines the challenge mechanism, level of trust, and the underlying authentication module or plug-in required to authenticate a user. Several default schemes provided with Access Manager and Administrators can define their own schemes.</p> <p>Authenticating a user's identity with Access Manager refers to running a pre-defined set of processes to verify the digital identity of the user. One authentication scheme can be assigned to multiple authentication policies. However, each authentication policy can have only one authentication scheme assigned to it.</p> <p>Note: Authentication schemes are defined globally to ensure that a small number of Administrators define them in a consistent, secure way.</p> <p>See Also: "Managing Authentication Schemes"</p>
Authentication Modules and Plug-ins	<p>The smallest executable unit of an authentication scheme. The authentication module determines the exact procedure to be followed and the method for challenging the user for credentials.</p> <p>Authentication involves determining which credentials a user must supply when requesting access to a resource, gathering credentials, and returning a response that is based on the results of credential validation.</p> <p>All authentication processing relies on an authentication module to define the rules governing requirements and transmission of information to the backend authentication scheme. All information collected by the plug-in and saved in the context is available to the plug-in through the authentication process. Context data can also be used to set cookies or headers in the user's login page</p> <p>A number of plug-ins and several pre-defined modules are provided. Oracle strongly recommends using plug-ins, which you can configure and orchestrate as needed to provide multi-step authentication.</p> <p>See Also:</p> <ul style="list-style-type: none"> • "Managing Native Authentication Modules" • "Orchestrating Multi-Step Authentication with Plug-in Based Modules"

Access Manager Policy Components

Access Manager default behavior denies access when a resource is not protected by a policy that explicitly allows access. [Table 21-4](#) describes policy components you configure to allow access and where you can find the details.

See Also:

["Anatomy of an Application Domain and Policies"](#)

Table 21-4 Access Manager Policy Components

Component	Description
Application Domain	<p>Each Application Domain provides a logical container for resources, and the associated policies that dictate who can access these resources. An application domain can be created automatically during Agent registration or manually using the console.</p> <p>See Also: "Anatomy of an Application Domain and Policies"</p>
Resource Definitions	<p>Based on a defined host identifier, Administrators can add specific resources to an Application Domain and apply policies to protect those resources.</p> <p>See Also: "Adding and Managing Policy Resource Definitions".</p>
Authentication Policy	<p>Each resource defined in an Application Domain can be protected by only one authentication policy. Each authentication policy requires one authentication scheme.</p> <p>One authentication policy can protect many resources. However, each resource can be protected by only one authentication policy.</p> <p>See Also: "Defining Authentication Policies for Specific Resources"</p>
Authorization Policies	<p>Each resource assigned to an Application Domain can be protected by only one authorization policy. Each policy can include one or more conditions and a rule. Authorization policies can also contain success responses.</p> <p>One authorization policy can protect many resources. However, each resource can be protected by only one authorization policy.</p> <p>See Also: "Defining Authorization Policies for Specific Resources".</p>
Token Issuance Policy	<p>By default, only a container for Token Issuance Policies is provided in a generated Application Domain. No Conditions or Rules are generated automatically. You must add these manually.</p> <p>See Also: "Token Issuance Policy Pages".</p>
Policy Responses	<p>Available for all policy types, Authentication and Authorization success Responses can be defined within respective policies to be applied after policy evaluation.</p> <p>See Also: "Introduction to Policy Responses for SSO".</p>
Rule	<p>Available for only Authorization and Token Issuance Policies.</p> <p>Each Authorization policy includes a rule that defines whether the policy allows or denies access to resources protected by the policy.</p> <p>The rule references Authorization conditions, described next.</p> <p>See Also: "Introduction to Authorization Policy Rules and Conditions".</p>
Condition	<p>Available for only Authorization and Token Issuance Policies.</p> <p>Each Authorization policy rule references conditions that define to whom the rule applies, if there is a time Condition, and how evaluation outcomes are to be applied.</p> <p>Conditions are declared outside of rules and are referenced within a rule.</p> <p>See Also: "Introduction to Authorization Policy Rules and Conditions".</p>

21.3 Anatomy of an Application Domain and Policies

Access Manager enables you to control who can access resources based on policies defined within an Application Domain. Users attempt to access a protected resource by entering a URL in a browser, by running an application, or by calling some other

external business logic. When a user requests access to a protected resource, the request is evaluated according to policies that discriminate between authenticated users who are authorized and those who are not authorized for access to a particular resource. Application domains do not have any hierarchical relationship to one another. Each Application Domain can be made to contain policy elements related to an entire application deployment, a particular tier of the deployment, or a single host.

Within each Application Domain, specific resources are identified for protection by specific policies that govern access. Authentication and authorization policies include Administrator-configured responses that are applied upon successful evaluation. Authorization policies include Administrator-configured conditions and rules that define how evaluation is performed, and responses to be applied upon successful evaluation.

The size and number of Application Domains is up to the Administrator. The decision can be based on individual application resources or any other logical grouping as needed. An Application Domain is automatically created during Agent registration. Also, Administrators can protect multiple Application Domains using the same agent by manually creating the Application Domain and adding the resources and policies.

Figure 21-3 shows an expanded view of policies within an Application Domain, as well as how the shared elements are used in an Application Domain.

Figure 21-3 Anatomy of Access Manager Policies

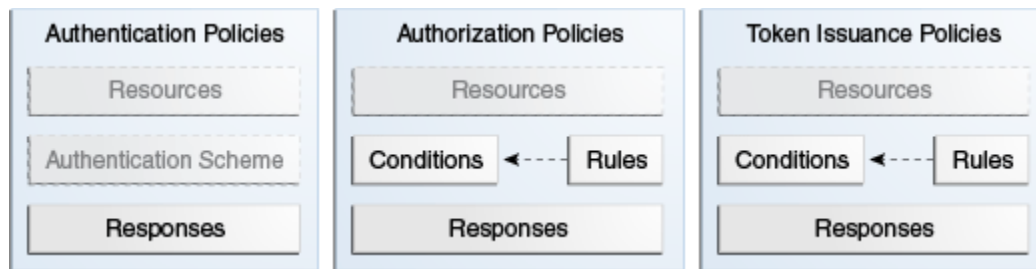

For more information, see the following topics:

- [Resource Definitions for Policies](#)
- [About Authentication Policies](#)
- [About Authorization Policies](#)
- [About Token Issuance Policies](#)

21.3.1 Resource Definitions for Policies

The term *resource* represents a document, or entity, or pieces of content stored on an OAM Server and available for access by a large audience.

Clients communicate with the OAM Server to request a resource using a particular protocol (HTTP or HTTPS, for example), which corresponds to an existing Resource Type. Every HTTP Resource Type must be associated with a host identifier. However, non-HTTP Resource Types are associated with a specific name (not a host identifier).

With Access Manager, each resource must be defined as within the Resources container in an Application Domain before it can be associated with a specific policy.

Note:

Only resources defined in the Resources container can be associated with policies in the Application Domain.

For more information, see "[Adding and Managing Policy Resource Definitions](#)".

Note:

To protect pieces of content on a page, Oracle recommends using Oracle Entitlements Server.

21.3.2 About Authentication Policies

Administrators can create an authentication policy to apply to specific resources within an Application Domain.

Each authentication policy:

- Identifies the specific resources covered by this policy, which must be defined on the Resources tab of this policy and in the Resources container for the Application Domain
- Specifies the authentication scheme that provides the challenge method to be used to authenticate the user
- Specifies the Success URL (and the failure URL) that redirects the user based on the results of this policy evaluation
- Defines optional Responses that identify post-authentication actions to be carried out by the Agent.

Policy responses provide the ability to insert information into a session and pull it back out at any later point. This is more robust and flexible than Oracle Access Manager 10g, which provided data passage to (and between) applications by redirecting to URLs in a specific sequence.

Policy responses are optional. These must be configured by an Administrator and are applied to specific resources defined within the Application Domain. For more information, see "[Introduction to Policy Responses for SSO](#)".

Authentication Policy Evaluation Results

To authenticate a user, Access Manager presents the user's browser with a request for authentication credentials based on the challenge method defined by the authentication scheme for this policy.

After policy evaluation, the result is returned and the user is redirected based on that result:

- Success (allow access) redirects to the requested URL
- Failure, (deny access) redirects to a generic error page

Note:

Policy evaluation results can be overridden policy by policy.

See Also:

- ["Authentication Policy Pages"](#)
 - ["Managing Run Time Policy Evaluation Caches"](#)
-
-

21.3.3 About Authorization Policies

Authorization is the process of determining if a user has a right to access a requested resource.

A user might want to see data or run an application program protected by a policy, for example.

Administrators can create an authorization policy to specify the conditions under which a subject or identity has access to a particular resource. The requested resource must belong to an Application Domain and must be included within a specific authorization policy.

Each authorization policy:

- Identifies the specific resources covered by this policy, which must be defined on the Resources tab of this policy and in the Resources container for the Application Domain
- Specifies the Success URL (and the failure URL) that redirects the user based on the results of this policy evaluation
- Identifies specific Allow or Deny Rules based on defined conditions for this policy and resources. See [Table 21-5](#) for an overview of Condition types.
- Defines optional Responses that identify post-authorization actions to be carried out by the Agent, as described in ["Introduction to Policy Responses for SSO"](#).

See Also:

["Policy Conditions and Rules"](#)

21.3.4 About Token Issuance Policies

A Token Issuance Policy defines the rules under which a token can be issued for a resource (Relying Party Partner) based on the client's identity. The client can be either a Requester Partner or an end user.

Unless explicitly stated, information on Application Domains and authorization policies applies equally to Token Issuance policies.

Note:

During automatic policy generation, no Token Issuance Policies are created; only the container for Token Issuance Policies is generated automatically.

For specific information about Token Issuance Policies, see:

- ["Managing TokenServiceRP Type Resources"](#)
- ["Managing Token Issuance Policies, Conditions, and Rules"](#)

21.4 Policy Conditions and Rules

Conditions can be specified only within Authorization and Token Issuance policies. Rules define the Allow or Deny specification that determines the overall effect of the policy.

Unless explicitly stated, information on policy Conditions and Rules applies equally to authorization and Token Issuance policies.

Conditions

Conditions are used in conjunction with Rules that specify Allow or Deny access, based on defined Conditions. [Table 21-5](#) identifies available condition types.

Table 21-5 Condition Types

Type	For more information, see ...
Identity	"Introduction to Authorization Policy Rules and Conditions" .
IP4 Range	"Defining IP4 Range Conditions" .
Temporal	"Defining Temporal Conditions" .
Attribute	"Defining Attribute Conditions" .
True	Effectively "Allow All". Oracle recommends this be used as the default option in cases where you need to let in any authenticated use. In this case, you do not need any particular conditions to be satisfied at authorization time. This replaces the Use Implied Constraints flag the previous release of Access Manager, which similarly lets policy evaluation complete with an Allow result when no specifically-defined constraints were present.

Each Authorization and Token Issuance policy can contain one or more condition objects. There can be more than one instance of a type of condition in a policy (the previous policy model allowed only one instance of a class in a policy).

Conditions are similar to earlier Access Manager 11g authorization constraints. However, constraints included Allow or Deny specifications and conditions do not.

Rules

Rules are new constructs in the policy model. Each Rule defines the Allow or Deny specification that determines the overall effect of the policy. Rules also define how the outcomes of each Condition evaluation is to be combined. Conditions are referenced in rules and declared outside of rules.

Within a Rule, evaluation outcomes can be combined as follows:

- **Simple Mode:** Accepts a list of condition names that are combined based on the value of a combiner that allows either All conditions to be met or Any one condition to be met to return "true" for the evaluation. [Previously, ALL allowed constraints while ANY denied them.]
- **Expression mode:** Allows the user to specify a Boolean expression to combine conditions using condition names and special characters (comma, vertical bar, ampersand and exclamation point: , | & and !).

Note:

A policy in which there are one or more conditions that are not part of either an Allow or Deny Rule is treated as a valid policy.

For more information about Conditions and Rule, see [Managing Policies to Protect Resources and Enable SSO](#).

21.5 Understanding SSO Cookies

Here is an overview of single sign-on with Access Manager 11g.

It includes the following topics:

- [Single Sign-On Cookies During User Login](#)
- [Single Sign-On Server and Agent Cookies](#)

21.5.1 Single Sign-On Cookies During User Login

Single Sign-On Cookies can be set or cleared during user login.

[Table 21-6](#) describes the cookies in detail.

Table 21-6 SSO Cookies

SSO Cookie Set at User Login	Set By	Description
OAM_ID cookie	OAM Server Embedded Credential Collector	When a user attempts to access a protected application, the request comes to the SSO Engine and the controller checks for the existence of the cookie. See Also: " OAM_ID cookie ".
OAMAuthnCookie	11g Webgate	Set by each 11g Webgate that is contacted. Protected by the key known to the respective 11g Webgate and the OAM Server. A valid OAMAuthnCookie is required for a session. Note: If the user accesses applications protected by different 11g Webgates, you will have multiple OAMAuthnCookies. See " OAMAuthnCookie for 11g OAM Webgates ".

Table 21-6 (Cont.) SSO Cookies

SSO Cookie Set at User Login	Set By	Description
		<p>A domain-based cookie for 10g Webgates is set only when a 10g Webgate is contacted. Protected with keys known to the OAM Server only. One global shared secret key for all Webgates.</p> <p>Note: This cookie enables backward compatibility and inter-operability between Access Manager 11g and older agents.</p> <p>See "ObSSOCookie for 10g Webgates"</p>
OAM_REQ	OAM Server Embedded Credential Collector	<p>A transient cookie that is set or cleared by the OAM Server if the Authentication request context cookie is enabled. Protected with keys known to the OAM Server only.</p> <p>Note: This cookie is configured as a high availability option to store the state about user's original request to a protected resource while his credentials are collected and authentication performed.</p> <p>See "OAM_REQ Cookie".</p>
OAMRequestContext	11g Webgate	<p>Set or cleared by the 11g Webgate and protected by the key known to the respective 11g Webgate and the OAM Server.</p> <p>With Internet Explorer browser:</p> <p>--When RequestContextCookieExpTime is not set, OAMRequestContext is a transient cookie.</p> <p>--When RequestContextCookieExpTime is set, the OAMRequestContext cookie expires by the time set using the "Expires" directive. This requires a time sync between the client host and Web server host.</p> <p>With all other (non-IE) browsers, when RequestContextCookieExpTime is not set OAMRequestContext expires in 5 minutes by default or by the time set using the "Max-Age" directive.</p> <p>See Also: "OAMRequestContext"</p> <p>Table 15-2</p>
DCCCtxCookie	Detached Credential Collector	<p>For detached credential collector (DCC)--similar to OAM_REQ created by embedded credential collector (ECC).</p> <p>See "DCCCtxCookie"</p>
OHS-host-port	Oracle HTTP Server	<p>Set only when OSSO Agents (mod_osso) are contacted on Oracle HTTP Server (OHS). Protected with the key known to the respective mod_osso agent and the OAM Server.</p> <p>Note: This cookie enables backward compatibility and inter-operability between Access Manager 11g and older agents.</p> <p>See "mod_osso Cookies".</p>

Table 21-6 (Cont.) SSO Cookies

SSO Cookie Set at User Login	Set By	Description
OAM_GITO cookie	OAM Server	Provides backward compatibility and inter-operability between OSSO 10g and Access Manager 11g. The cookie is created by the OAM Server and accessed or modified by the OAM Server or mod_osso agent. See " mod_osso Cookies ".
OpenSSO cookie	OpenSSO Proxy	See " OpenSSO Cookie (iPlanetDirectoryPro) ".

For details about configuring authentication and authorization policies, see [Managing Policies to Protect Resources and Enable SSO](#).

21.5.2 Single Sign-On Server and Agent Cookies

The following sections provide information on the SSO server and agent cookies.

- [OAM_ID cookie](#)
- [OAMAuthnCookie for 11g OAM Webgates](#)
- [ObSSOCookie for 10g Webgates](#)
- [OAM_REQ Cookie](#)
- [OAMRequestContext](#)
- [DCCCtxCookie](#)
- [DCCCtxCookie_COUNT](#)
- [mod_osso Cookies](#)
- [OpenSSO Cookie \(iPlanetDirectoryPro\)](#)

21.5.2.1 OAM_ID cookie

The OAM_ID cookie is scoped to the OAM Server. OAM_ID is generated by the OAM Server when the user is challenged for credentials, and submitted to the server on every redirect to the server. OAM_ID is protected by keys known to the OAM Server only.

When a user attempts to access a protected application, the request comes to the SSO Engine and the controller checks for the existence of the cookie:

- If the cookie does not exist, user authentication begins. After successful authentication, the user context and token are set by the SSO Engine. The cookie is set with the global user ID (GUID), creation time, and idle timeout details. Information in the cookie is encrypted with the SSO Server key and can be decrypted only by the SSO Engine.
- If the cookie exists, then the cookie is decrypted and the sign in flow completes with the authenticated user.

21.5.2.2 OAMAuthnCookie for 11g OAM Webgates

There is one OAMAuthnCookie_<host:port>_<random number> set by each 11g Webgate using the authentication token received from the OAM Server after successful authentication. A valid OAMAuthnCookie is required for a session.

SSL Connections: Administrators can ensure the ObSSOCookie is only sent over an SSL connection and prevents the cookie from being sent back to a non-secure Web server by configuring SSL and then specifying Simple or Cert mode for Agents and Servers. For details, see "[About Communication Between OAM Servers and WebGates](#)".

Cookie Expiration: For 11g Webgate and OAMAuthnCookie, expiration is controlled by the "tokenValidityPeriod" parameter, which controls the valid token (or cookie) time.

This key is known to both the 11g Webgate and SSO Engine and is used for encrypting OAMAuthnCookie. The SSO engine key (only known to the SSO Engine) is used for encrypting the OAM_ID OAM Server cookie.

Similar to ObSSOCookie for 10g Webgates.

21.5.2.3 ObSSOCookie for 10g Webgates

Access Manager 11g sets a key-based cookie *ObSSOCookie* for each user or application that accesses a resource protected by a 10g Webgate. The key is set up during agent registration and is known to both the agent and SSO Engine (shared between them). This key is different from the OAM Server (or SSO Engine) key.

Removing the ObSSOCookie causes the 10g Webgate to log the user out and requires the user to re-authenticate the next time he or she requests a resource that is protected by the Access System.

The WebGate sends the ObSSOCookie to the user's browser upon successful authentication. This cookie can then act as an authentication mechanism for other protected resources that require the same or a lower level of authentication. When the user requests access to a browser or another resource, the request flows to the OAM Server. The user is logged in, and the ObSSOCookie is set. The OAM Server generates a session token with a URL that contains the ObSSOCookie. Single sign-on works when the cookie is used for subsequent authorizations in lieu of prompting the user to supply authorization credentials.

When the cookie is generated, part of the cookie is used as an *encrypted session token*. The single sign-on cookie does not contain user credentials such as user name and password.

SSL Connections: Administrators can ensure the ObSSOCookie is only sent over an SSL connection and prevents the cookie from being sent back to a non-secure Web server by configuring SSL and then specifying Simple or Cert mode for Agents and Servers. For details, see "[About Communication Between OAM Servers and WebGates](#)".

Cookie Expiration: Administrators can specify the desired Cookie Session Time in the OAM Agent registration. For more information, see "[Registering an OAM Agent Using the Console](#)".

21.5.2.4 OAM_REQ Cookie

A transient cookie that is set or cleared by the OAM Server if the Authentication request context cookie is enabled. Protected with keys known to the OAM Server only.

This cookie is configured as a high availability option to store the state about user's original request to a protected resource while his credentials are collected and authentication performed.

In high availability configurations, the Request Cache type must be changed from BASIC to COOKIE using Infrastructure Security custom WLST commands.

Note:

You must invoke the WLST script from the Oracle Common home. See *How to Launch the Command-Line Interface* in *Administering Oracle Fusion Middleware*.

See Also:

- *WLST Command Reference for WebLogic Server*
 - [Table 21-6](#)
-
-

21.5.2.5 OAMRequestContext

The OAMRequestContext is set or cleared by the 11g Resource WebGate and protected by the key known to the respective 11g WebGate and the OAM Server.

This cookie is configured to store the state about the user's original request to a protected resource while his credentials are collected and authentication performed.

- With Internet Explorer browser:
 - When RequestContextCookieExpTime is not set, OAMRequestContext is a transient cookie.
 - When RequestContextCookieExpTime is set, the OAMRequestContext cookie expires by the time set using the "Expires" directive. This requires a time sync between the client host and Web server host.
- With all other (non-IE) browsers, when RequestContextCookieExpTime is not set OAMRequestContext expires in 5 minutes by default or by the time set using the "Max-Age" directive.

See Also:

RequestContextCookieExpTime in [Table 15-2](#)

21.5.2.6 DCCctxCookie

The DCCctxCookie comes into play only with the Detached Credential Collector (DCC). The DCCctxCookie is used by DCC to save various context information required during authentication.

It includes information necessary to reconstruct the original request upon completion of authentication, to maintain server affinity, and to perform iterative multi-step authentication.

By default, DCCctxCookie is set when the DCC is first redirected away to collect credentials based on the authentication scheme (when the browser is first redirected to the login form with a form-based authentication scheme).

With the DCC, once authenticated the OAM server issues a DCC master session token to the DCC in the authenticate response. DCC then sets a host-based DCC cookie using the token and:

- **If DCC cookie Presented During Authentication:** DCC decrypts the token using a DCC key, and performs partial token validation locally (integrity check, token validity period check). If it passes, DCC performs complete token validation for timeout aspects over the OAP channel against the OAM Server.
- **If no DCC Cookie:** This indicates a first time authentication which initiates credential collection, performs sanity and syntactic checks on the credential and submits to OAM Server for validation.

See Also:

["Configuring 11g WebGate and Authentication Policy for DCC"](#)

21.5.2.7 DCCctxCookie_COUNT

DCCctxCookie_COUNT cookie maintains the number of cookies generated after splitting the DCCctxCookie. While the count is determined by the DCCctxCookie_COUNT cookie, the configuration parameter, MaxSplittedCookieSize fixes the size of each DCCctxCookie cookie. By default, the size is set to 4 KB.

This feature enables the Webgate to handle large DCCctxCookie cookies. When the size of the DCCctxCookie exceeds 4 KB, some browsers do not support and the user authentication fails. Set appropriate value for the Webgate configuration parameter, MaxSplittedCookieSize in order to split the DCCctxCookie cookie into multiple cookies each of size 4 KB or less. The number of cookies generated after the split of DCCctxCookie cookie is tracked by DCCctxCookie_COUNT cookie.

For example, when the requested URL is too long, the size of DCCctxCookie cookie becomes 6 KB. With the default setting, the DCCctxCookie splits into two cookies as follows:

DCCctxCookie_HOST:PORT_1 (size: 4 KB)

DCCctxCookie_HOST:PORT_2 (size: 2 KB)

You may encounter a 'bad request' error while handling a long URL. To avoid this error, edit httpd.conf file and add LimitRequestFieldSize parameter. The default value for LimitRequestFieldSize is 8 KB.

21.5.2.8 mod_osso Cookies

The mod_osso module is the Oracle HTTP Server module that provides authentication to OracleAS applications. This module resides on the Oracle HTTP Server that enables applications protected by OracleAS Single Sign-On to accept HTTP headers in lieu of a user name and password once the user has logged into the OracleAS Single Sign-On server. The values for these headers are stored in a mod_osso cookie. Located on the application server, mod_osso simplifies the authentication process by serving as the sole application to the single sign-on server. In this way, mod_osso renders authentication transparent to OracleAS applications.

The Administrator for these applications is spared the burden of integrating them with an SDK. After authenticating a user, `mod_osso` transmits the simple header values that applications may use to authorize the user.

OAM_GITO Cookie

Needed in special cases to support timeout when multiple types of agents (`mod_osso` and `WebGate`) are working with Access Manager 11g. Server side session managers can check the validity of the cookie for expiry and timeout during session validation. Global logout is required for OSSO Agents (`mod_osso`) to ensure that logging out of a session on any entity propagates the logout to all entities.

When a user is authenticated by OSSO 10g, the OSSO Server sets the `OAM_GITO` cookie. Once the partner cookie (OHS cookie) is set, OHS does not route the request to the server. Instead, on every access, OHS decrypts the `OAM_GITO` cookie and updates the last activity timestamp. During request processing, if any partner detects that current time has surpassed GITO timeout (last activity time + GITO timeout), the request is sent to OSSO 10g in forced authentication mode. When a request reaches OSSO server in forced authentication mode, server chooses to ignore `SSO_ID` cookie and challenges user for credentials, considering it as a fresh request. After successful authentication, `SSO_ID` and `OAM_GITO` cookie are updated.

This is enabled (using the `editGITOvalues WLST` command), as described in the *WLST Command Reference for WebLogic Server*.

OssoSecureCookies Directive

Add the `OssoSecureCookies` directive to set the `Secure` flag on all cookies. This tells the browser to only transmit those cookies on connections secured by HTTPS. An example of this directive in a `mod_osso` configuration (`mod_osso.conf`), is as follows:

```
<IfModule mod_osso.c>
OssoIpCheck off
OssoIdleTimeout off
OssoSecureCookies on
OssoConfigFile osso/osso.conf
<Location /j2ee/webapp>
require valid-user
AuthType Basic
</Location>
</IfModule>
```

For more information, see *Oracle Application Server Single Sign-On Administrator's Guide*.

21.5.2.9 OpenSSO Cookie (iPlanetDirectoryPro)

The agent finds OpenSSO Cookie after the OpenSSO Proxy triggers session validation. The default name of the OpenSSO cookie is `iPlanetDirectoryPro`.

After the OpenSSO agent is authenticated and logged in, the agent verifies whether the user has an OpenSSO cookie. If not, the user authentication request is initiated from the OpenSSO Agent. During SSO User Login and Authentication flow OpenSSO cookie is created, which contains the OpenSSO session identifier, and this cookie is set in the user's browser.

During End User Session Validation, OpenSSO agent intercepts the request to the protected application and finds an OpenSSO cookie.

During User Single Logout, the OpenSSO Proxy receives a User logout request and forwards the user to the OAM Logout URL. OpenSSO Proxy decrypts the OpenSSO cookie, fetches the OpenSSO session identifier and, from that, fetches the OAM session ID. OpenSSO proxy sends the logout request to controller through the OpenSSO logout event with the OAM session ID.

- SSO User Login and Authentication flow
- End User Session Validation flow
- User Single Logout flow

21.6 Configuring Single Sign-On with Access Manager

Here is an outline of tasks that Administrators must perform to configure single sign-on with Access Manager 11g.

For each task, a link to additional information is included.

1. Review all topics in this chapter to get familiar with the Access Manager 11g SSO policy model.
2. Configure a single sign-on logout URL for each application you want to protect, using documentation for your specific application.
3. Install and register an Agent on each Web server that is hosting an application to protect using either method. See:
 - [Introduction to Agents and Registration](#)
 - [Registering and Managing OAM 11g Agents](#)
4. Proceed to manage resource types, host identifiers, authentication schemes, and modules:
 - [Managing Authentication and Shared Policy Components](#)
5. Locate an existing Application Domain (or start a fresh one) and add resources and policies, as described in:
 - [Managing Policies to Protect Resources and Enable SSO](#)

Managing Authentication and Shared Policy Components

Administrators can configure shared policy components, manage authentication schemes, and deploy and manage plug-ins for authentication.

- [Prerequisites to Managing Authentication and Shared Policy Components](#)
- [Configuring Shared Policy Components](#)
- [Managing Resource Types](#)
- [Managing Host Identifiers](#)
- [Understanding Authentication Methods and Credential Collectors](#)
- [Managing Native Authentication Modules](#)
- [Orchestrating Multi-Step Authentication with Plug-in Based Modules](#)
- [Deploying and Managing Individual Plug-ins for Authentication](#)
- [Managing Authentication Schemes](#)
- [Extending Authentication Schemes with Advanced Rules](#)
- [Configuring Challenge Parameters for Encrypted Cookies](#)
- [Configuring Authentication POST Data Handling](#)
- [Long URL Handling During Authentication](#)
- [Using Application Initiated Authentication](#)

22.1 Prerequisites to Managing Authentication and Shared Policy Components

The Oracle Access Management Console and at least one OAM Server must be installed and running within a WebLogic Server domain, and Access Manager must be running with at least two registered Agents.

Oracle recommends that you review information in [Understanding Single Sign-On with Access Manager](#) before performing activities in this section.

22.2 Configuring Shared Policy Components

You can configure shared policy components required for use in Access Manager authentication policies that protect resources and enable single sign-on.

See Also:

[Understanding Single Sign-On with Access Manager](#)

1. Confirm that the desired resource type is defined, as described in this chapter:
 - [Managing Resource Types](#)
2. Confirm that a host identifier definition named for the agent was created during agent registration, (or create one yourself), as described in:
 - [Managing Host Identifiers](#)
3. Gain comprehension about credential collection with Access Manager:
 - [Understanding Authentication Methods and Credential Collectors](#)
4. Learn about and use the authentication plug-ins that enable multi-step authentication:
 - [Orchestrating Multi-Step Authentication with Plug-in Based Modules](#)
 - [Deploying and Managing Individual Plug-ins for Authentication](#)
5. Create and manage authentication schemes that you can add to authentication policies, as described in:
 - [Managing Authentication Schemes](#)
 - [Configuring Challenge Parameters for Encrypted Cookies](#)
6. Set up your own global password policy for either the default embedded or optional detached credential collector (unless specified, tasks apply to both ECC and DCC, with minor changes noted in the discussion):
 - [Accessing Password Policy Configuration Page](#)
 - [Managing Global Password Policy](#)
 - [Configuring Password Policy Authentication](#)
 - [DCC: Configuring 11g WebGate and Authentication Policy for DCC](#)
 - [Completing Password Policy Configuration](#)
7. Proceed to [Managing Policies to Protect Resources and Enable SSO](#) to set up authentication policies.

22.3 Managing Resource Types

Administrators can add a resource to an application domain, search a defined resource type, or create a defined resource type.

- [Resource Types and Their Use](#)
- [Resource Type Page](#)
- [Searching for a Specific Resource Type](#)

- [Creating a Custom Resource Type](#)

22.3.1 Resource Types and Their Use

When adding a resource to an Application Domain, Administrators must choose from a list of defined Resource Types.

Oracle-provided resource types include:

- HTTP
- wl_authen
- TokenServiceRP

Administrators can configure additional resource types, and define operations on both Oracle-provided and custom resource types. A particular resource can be defined to use a subset of the declared operations, or all of them (which includes any new operators defined on the resource's type subsequently). Administrators cannot remove custom resource types or operations for which resources have been created. Oracle-provided resource types and operations are marked as read-only within the policy store and cannot be removed.

Note:

Changes to the operation list of a resource type is not allowed if a resource of that type exists.

[Table 22-1](#) compares resource types and operations.

Table 22-1 Comparison: Resource Types for Access Manager versus 10g

Access Manager 11g	Oracle Access Manager 10g
<p>HTTP: The default resource type used with HTTP and HTTPS protocols.</p> <p>When adding an HTTP type resource to an Application Domain, Administrators must choose from a list of existing host identifiers and add the resource URL.</p> <p>This resource type is read-only. Default operations associated with the HTTP resource type need not be defined by an Administrator. Instead, policies developed and applied to the resource apply to all operations:</p> <p>Operations: Oracle-provided resource types are read-only; associated operations are pre-defined. Policies developed and applied to HTTP type resources apply to all operations.</p> <ul style="list-style-type: none"> • Get • Post • Put • Head • Delete • Trace • Options • Connect • <i>Other</i> <p>See Also: "Resource Type Page".</p>	<p>HTTP: The HTTP resource type is read-only.</p> <p>Operations: Oracle-provided resource types are read-only; associated operations are pre-defined. Policies developed and applied to the resource apply to all operations.</p> <ul style="list-style-type: none"> • Get • Post • Put • Head • Delete • Trace • Options • Connect • <i>Other</i>

Table 22-1 (Cont.) Comparison: Resource Types for Access Manager versus 10g

Access Manager 11g	Oracle Access Manager 10g
<p>wl_authen: Resources for representing WebLogic Authentication schemes is also read-only (default operations cannot be modified or deleted.)</p> <p>This non-HTTP resource type is available to use with resources deployed in a WebLogic container in a domain that does not include Access Manager. The protected resource is accessed through its URL on the Oracle WebLogic Server.</p> <p>Type wl_authen resources, require a custom Access Client.</p>	N/A
<p>TokenServiceRP: Resources for representing Token Service Relying Party. The Operation for this resource type is Issue.</p>	N/A
<p>Custom Resource Types: Have no associated host identifier. A custom "EJB" resource type can be created on demand for use in SSO integrations.</p>	<p>EJB: A custom resource type used in SSO integrations with WebLogic and WebSphere for authenticating the user. During authentication, the user's groups were fetched and populated in the Subject Principal as roles. Subsequent authorization was executed inside the application server based on user roles.</p> <p>No authorization calls were made using resource operations.</p>
<p>Non-HTTP resource types have no associated host identifier. When adding non-HTTP resources to an Application Domain, Administrators must enter the Type name into the Resource URL field as a pointer. The name cannot match any host Identifier (and vice versa). This is not a relative HTTP URL.</p>	

22.3.2 Resource Type Page

In the Oracle Access Management Console, resource types are organized with other Components under the Policy Configuration tab. The navigation tree shows Oracle-provided resource types: HTTP, wl_authen, and TokenServiceRP.

Note:

Pre-defined resource types cannot be deleted. Pre-defined operations are shown with a lock icon and cannot be deleted. Additional operations can be created, edited, or deleted as needed.

The HTTP resource type, shown in [Figure 22-1](#), is used for Web applications protected by Access Manager and accessed using internet protocols (HTTP or HTTPS).

Figure 22-1 Default HTTP Resource Type Definition

HTTP Resource Type Duplicate Apply

Use the following screen to create a Resource Type. Custom Resource Types will be listed along with the default Resource Types when adding resources to an Authentication or Authorization policy.

Name HTTP

Resources for representing web resources used with

Description HTTP and HTTPS protocols.

⋮

This is a predefined resource type which cannot be deleted, nor can any operations initially defined on it. However, additional operations can be created, edited or deleted as needed. Predefined operations are shown with a lock icon.

Operations + ×

Operation
🔒 CONNECT
🔒 OPTIONS
🔒 POST
🔒 PUT
🔒 TRACE
🔒 GET
🔒 HEAD
🔒 DELETE

The w1_authen resource type is shown in [Figure 22-2](#). It is used for Fusion Middleware applications that use one of the following Access Manager Identity Assertion Provider configurations described in the *Securing Applications with Oracle Platform Security Services*:

- Identity Asserter
- Identity Asserter with Oracle Web Services Manager
- Authenticator function

Figure 22-2 Default Resource Type w1_authen

w1_authen Resource Type Duplicate Apply

Use the following screen to create a Resource Type. Custom Resource Types will be listed along with the default Resource Types when adding resources to an Authentication or Authorization policy.

Name w1_authen

Resources for representing WebLogic Authentication

Description schemes.

⋮

This is a predefined resource type which cannot be deleted, nor can any operations initially defined on it. However, additional operations can be created, edited or deleted as needed. Predefined operations are shown with a lock icon.

Operations + ×

Operation
🔒 LOGIN

The TokenServiceRP resource type represents the Token Service Relying Party, as shown in [Figure 22-3](#). The operation for this resource type is Issue. For more information, see "[Managing TokenServiceRP Type Resources](#)".

Figure 22-3 Default Resource Type TokenServiceRP Resource Type



Table 22-2 describes the elements in each resource type definition.

Table 22-2 Resource Type Definition

Element	Description
Name	Required. A unique name of up to 30 alpha or numeric characters. Note: A non-HTTP Resource Type name cannot match a Host Identifier (and vice versa).
Description	Optional. Use this field to describe the purpose of this resource type using up to 200 alpha or numeric characters. For example: Resources representing WebLogic Authentication schemes.
Operations	Optional. Policies that govern a particular resource apply to all specified operations defined for the resource. Add (or remove) operations for this resource type as a string and the operations will be available when you define a resource of this type within an Application Domain. There is no limit to the number of operations that can be added to the resource type. <ul style="list-style-type: none"> • Get • Post • Put • Head • Issue (TokenServiceRP) • Login (wl_authen) • Delete • Trace • Options • Connect • <i>Other</i> (available with Oracle Access Manager 10 is not supported in 11g). <p>Remote Registration: During automatic policy creation, specified operations are supported. During automatic policy creation with no operations specified, then All operations defined for that type are supported.</p> <p>Migration: During an upgrade to Access Manager 11.1.2 (from 10g or from 11.1.1.3 or from 11.1.1.5), resource definitions and HTTP default operations are handled automatically. However, you must create any custom resource types to replace 10g-provided EJB custom resource types which are no longer provided by Oracle. See</p> <p>See Also: "Resource Types and Their Use" and "Resources in an Application Domain".</p>

Following topics describe how to create, modify, and delete a resource type.

22.3.3 Searching for a Specific Resource Type

Users with valid Administrator credentials can to locate a defined resource type.

See Also:

["SSO Agent Search Page"](#)

1. In the Oracle Access Management Console, click **Application Security** at the top of the window.
2. In the Application Security console, click **Resource Types** in the Access Manager section.
3. In the **Name** field, enter the name of the Resource Type you want to find (with or without a wild card (*)), and click **Search**. For example:

*h**

Alternatively: Go to the desired Application Domain, open the **Resources** node to display controls for that domain, choose a Resource Type from the list, and click **Search**.

4. In the results table, you can:
 - **Edit or View:** Click the **Edit** button in the tool bar to display the configuration page.
 - **Delete:** Click the **Delete** button in the tool bar to remove the instance; confirm removal in the Confirmation window.
 - **Detach:** Click **Detach** in the tool bar to expand the table to a full page.
 - **Reorder Columns:** Select a **View** menu item to alter the appearance of the results table.

22.3.4 Creating a Custom Resource Type

Users with valid Administrator credentials can create a defined resource type.

For instance, you can define a custom resource type that applies to as few as one or two (or more) operations. Any defined custom resource type is listed with default resource types when adding resources to an authentication or authorization policy.

See Also:

- ["Resource Types and Their Use"](#)
 - ["Defining Resources in an Application Domain"](#)
-
-

1. In the Oracle Access Management Console, click **Application Security** at the top of the window.

2. In the Application Security console, click **Resource Types** in the Access Manager section.
3. Click **Create Resource** type.
4. In the page that appears, enter the following information:
 - **Name:** A unique name that identifies this resource type.
 - **Description:** Optional.
 - **Operations:** Click + in the **Operations** table, type the operation name into the field provided. Repeat as needed to define all operations for this resource type.
 - **Reconfigure Table:** Select a **View** menu item to alter the appearance of the results table.
5. Click **Apply** to submit this custom resource definition.
6. Add this resource definition to an Application Domain as described in "[Adding and Managing Policy Resource Definitions](#)".

22.4 Managing Host Identifiers

Administrators can create, modify, and remove host identifiers manually.

- [About Host Identifiers](#)
- [About Virtual Web Hosting](#)
- [Host Identifier Page](#)
- [Creating a Host Identifier](#)
- [Searching for a Host Identifier Definition](#)
- [Viewing or Editing a Host Identifier Definition](#)
- [Deleting a Host Identifier Definition](#)

22.4.1 About Host Identifiers

Access Manager policies protect resources on computer hosts. Within Access Manager, the computer host is specified independently using a host identifier.

[Table 22-3](#) illustrates the different host names under which a Web server might be accessible to employees. Creating a single Host Identifier using all of these names allows you to define a single set of policies to appropriately protect the application, regardless of how the user accesses it.

Table 22-3 *Host Identifiers Examples*

Sample Host Identifier	Description
hrportal.intranet.company.com	A friendly name employees can remember. This is a load-balanced proxy, and requests to this could actually utilize one of several servers hosting the HR application.
hr-sf-02.intranet.company.com	A single machine hosting the application, which can be accessed directly.

Table 22-3 (Cont.) Host Identifiers Examples

Sample Host Identifier	Description
hrportal.company.com	The same application is also accessible externally to the corporate firewall, primarily for use by ex-employees to check benefits, 401k info, and so on. This is also a load-balanced reverse proxy.

Based on a defined host identifier, Administrators can add specific resources to an Application Domain and apply policies to protect those resources.

Registered Agents protect all requests that match the addressing methods defined for the host identifier used in a policy. A request sent to any address on the list is mapped to the official host name and Access Manager can apply the policies that protect the resource and OAM can apply the policies that protect the resource.

A host identifier is automatically created when an Agent (and application) are registered using either the Oracle Access Management Console or the remote registration tool. Administrators can manually add a host identifier if an application and resources exist on a host that does not have a mapped host identifier. Also, Oracle Access Management Administrators can modify an existing host identifier to add in the new host name variations. For instance, adding another proxy Web server with a different host name requires a new host name variation.

For more information, see:

- [Host Identifier Usage](#)
- [Host Identifier Guidelines](#)
- [Host Identifier Variations](#)

22.4.1.1 Host Identifier Usage

At design time, the host identifier can be used while defining which resources belong to a specific Application Domain. Resources are scoped using their host identifier (HTTP) or type (non-HTTP). This combination uniquely identifies them across Access Manager.

Note:

Each resource should be unique across all Application Domains; each resource and host identifier combination must be unique across all Application Domains.

Runtime Usage

At run time, Web server host information in the access query from an OAM Agent is mapped to a host identifier and associated with the resource that is being accessed by a user. The OAM Agent obtains the Web server host information in one of two ways:

- If the Preferred Host parameter is configured for virtual Web hosting support (see "[About Virtual Web Hosting](#)"), Web server host information for the given request is obtained from the Web server.

- If the Preferred Host parameter directly specifies the Web server host information, it is always used irrespective of the Web server's own host information.

This allows for the Resources to be specified in terms of logical host names in their Host Identifiers, instead of the host names matching the present deployment of the Web server.

For instance, a user accessing `aseng-wiki`, would enter:

```
http://example-wiki.uk.example.com/wikiexample
```

Here, `wikiexample` is the resource URL and `example-wiki.uk.example.com` is the host. Matching this host and port (port is 80) provides the host identifier.

Preferred Host

Web server host information is generally acquired by setting the Preferred Host string of the OAM Agent. If the Agent is actively protecting multiple virtual hosts, this string can be set to `server_name` to ensure that the actual request hostname is correctly picked up from the Web server's request object. For more information, see "[About Virtual Web Hosting](#)"

Authenticating Hosts and Challenge Redirect in Authentication Schemes

When a user attempts to access a protected resource URL, she is redirected to the server specified in the Challenge Redirect field of the authentication scheme. If the authentication challenge is to be processed by another host, the name of that host must be defined to be available in the Host Identifiers list. For example, if a user is redirected to an SSL-enabled server for authentication, that server must be defined as a host identifier.

Note:

If you enter a host name in the Challenge Redirect field of an authentication scheme, it must be defined as a Host Identifier.

22.4.1.2 Host Identifier Guidelines

Each host identifier can be defined to represent one or more Web server hosts.

Following are several important guidelines for host identifiers:

- Each host name must be unique.
- Each *host name:port* pair must be unique.
- Each *host name:port* pair must belong to only one host identifier.
- Each *host name:port* pair must match the end user's entry exactly.
- A Host Identifier name cannot match a non-HTTP Resource Type name (and vice versa).
- Each resource and host identifier combination must be unique across all Application Domains.

For more information, see "[Host Identifier Variations](#)".

22.4.1.3 Host Identifier Variations

Host identifiers are used to simplify the identification of a Web server host by defining all possible hostname variations. Host identifiers consist of a list of all URL addressing methods. A host identifier must be configured for each Web site or virtual Web site that you want to protect with Access Manager.

You can identify Web server hosts to Access Manager in various ways, for example, by providing a computer name or an IP address. The following are examples of how the same host can be addressed:

- example.com
- example.com:80
- www.example.com
- www.example.com:80
- 216.200.159.58
- 216.200.159.58:80

22.4.2 About Virtual Web Hosting

You can install a Webgate on a Web server that contains multiple Web site and domain names. The Webgate must reside in a location that enables it to protect all of the Web sites on that server.

The information here is the same for both 11g and 10g Webgates.

The virtual Web hosting feature of many Web servers enables you to support multiple domain names and IP addresses that each resolve to their unique subdirectories on a single virtual server. For example, you can host abc.com and def.com on the same virtual server, each with its own domain name and unique site content. You can have name-based or IP-based virtual hosting.

A virtual host referees the situation where the same host has multiple sites being served either based on multiple NIC cards (IP based) or multiple names (for example, abc.com and def.com resolving to same IP).

Consider a case where you have two virtual hosts configured on an OHS Server acting as reverse proxy to OAM Server, as follows:

- One virtual host is configured in two-way SSL mode
- One virtual host configured in non-SSL mode

Suppose there are two resources protected with different authentication schemes and Application Domains:

- */resource1* is protected by a X509Scheme with a Challenge URL (to define the credential collection URL) of `https://ssl@host:port/`

When the user accesses */resource1* he is redirected to the OHS Server on the SSL port for authentication and is asked for the X.509 Certificate.

- */resource2* is protected by a LDAPScheme on the second virtual host with a Challenge Redirect of `http://host:port/`

When user accesses */resource2* he is redirected to second virtual host which is in non-SSL mode (or in one way SSL mode if required). The Login form for LDAP authentication is displayed.

Note:

Your deployment can support X.509 and Form authentication with 10g mod_osso. However, mod_osso can be configured for only one SSO Server. In this case, the Agent redirects to Access Manager on the non-SSL virtual host. The credential collector checks the Authentication Scheme's Challenge URL parameter for the resource and redirects back to the HTTPS virtual host for X509 authentication.

22.4.2.1 Placing a Webgate Behind a Reverse Proxy

You can use 10g Webgates with reverse proxies for Access Manager.

The benefits and pitfalls of this strategy are discussed here.

Benefits:

- All Web content can be protected from a single logical component as long as all requests go through the proxy.

This is true even for platforms that are not supported by Access Manager. If you have different types of Web servers (for example, iPlanet, Apache, and so on) on different platforms (for example, Windows XP, Linux, and so on), all content on these servers can be protected. A reverse proxy can be a workaround for unsupported Web servers, eliminating the need to write custom Access Clients for unsupported Web servers and on platforms that do not have Webgate support, for example, MacOS.

- A reverse proxy offers architecture flexibility.

Reverse proxies can allow deployments to expose an application that is available on the intranet to the extranet. Or applications that are available on the extranet can be exposed to the intranet. This can be done without any changes to the application that is already deployed.

- You only need to install a separate Webgate on the reverse proxy, rather than on every Web server.

This allows for a single management point and can help with manageability of the system. You can manage the security of all of the Web servers through the reverse proxy without establishing a footprint on the other Web Servers.

Pitfalls: The main pitfall of using a proxy is the extra work involved in setup. If you deploy the Webgate on a Web server that is behind a reverse proxy, the following are configuration requirements:

- Ensure that any Web server that uses the reverse proxy for authentication only accepts requests from the reverse proxies.

This will also require that Webgates deployed on this Web server be configured to not enforce IP validation for requests from the reverse proxy server that fronts the Webgate. This is done by configuring the known IP addresses of the reverse proxy server or servers in the IP Validation list. Note that while you can achieve the same effect by turning IP validation off for the Webgate, this is not a recommended approach due to security risks. Ensuring that the Web server only

accepts requests from reverse proxies is typically done by adding an ACL statement in the server. This prevents users from bypassing the reverse proxy and directly accessing restricted content.

- Update the virtual hosts that are configured in the Policy Manager so that the Access System intercepts requests that are sent to the reverse proxy.
- Prevent people from circumventing the proxy by entering URLs that point directly to the back-end system.

You can prevent this problem through the use of Web Server Access Control Lists or firewall filters.

- Since all user requests are processed by the proxy, you must deploy enough proxy servers to enable the system to handle the load.
- Redirect all existing URLs to the host name and port number of the reverse proxy server.

This often requires configuring the reverse proxy to perform content inspection and rewriting to prevent any absolute HTML links, for instance, to prevent broken link. This is achievable with most reverse proxies, and this is something you can configure independently of the Access System.

- It is a best practice that URL links exposed to the front-ended applications rely on only relative URLs (`../sub-path/resource`) rather than absolute URLs (`http://example.com:[port]/path/resource`).

Absolute URLs can break links on the end user's browser when deployed behind a reverse proxy.

22.4.2.2 Configuring Virtual Hosting for Non-Apache Web Servers

Ensure that the Virtual Host box is checked on the OAM Webgate registration page. On most Web servers, other than Apache-based servers, you must set the Preferred Host value to `HOST_HTTP_HEADER`. This ensures that, when user's browser sends a request, the Webgate sets the value of the Preferred Host to the host value in the request.

For example, suppose a user enters the string `example2` in a URL:

```
http://example2
```

On the Web server, if one of the Web sites has a host named `example2`, the request is served by the matching virtual site.

In the Preferred Host field of the expanded OAM Webgate registration page, enter the following:

```
HOST_HTTP_HEADER.
```

IIS Virtual Hosting: From the IIS console, you must configure each virtual Web site to contain the following fields:

- Host Header Name
- IP address
- Port

See Also:

- <http://www.simplifiedns.com/kb.aspx?kbid=1149>
 - <http://support.microsoft.com/kb/q190008/>
-

22.4.2.3 Associating a Webgate for Apache with Virtual Hosts, Directories, or Files

Ensure that the Virtual Host box is checked on the 10g Webgate registration page. On Apache-based Web servers (Apache, Apache 2, IBM HTTP Server, Oracle HTTP Server, and so on), the Preferred Host value must be set to SERVER_NAME.

Note:

The SERVER_NAME value is not supported for any host other than an Apache-based server. If you set this value for a non-Apache-based server, users will be unable to access any resources that are protected by Webgate on that Web server. Users will, instead, receive an error that the Webgate configuration is incorrect.

The ServerName directive must be explicitly set with 7777 along with the hostName. This is irrespective of the Listen directive is set correctly. The Server sometimes requires this value explicitly to identify itself, most often it can identify itself automatically.

When using an Apache-based reverse proxy for single sign-on, in the Web server configuration file (httpd.config, for example) file you specify the Web sites to run on the Apache server. The settings can be global across all Web sites or local to a Web site. You can restrict the Access Manager loading references in the httpd.config file to be associated with a specified site, with virtual hosts, specific directories or even files.

To associate the Webgate with specific targets, you move the following directives the the http.conf file:

```
AuthType Oblix
require valid-user
```

You can put these directives in a block that tells Apache to use Webgate for every request. You can also move the directives to a block that limits when the Webgate is called. The following is an example of putting the LocationMatch directive after a VirtualHost directive:

```
DocumentRoot /usr/local/apache/htdocs/myserver
ServerName myserver.example.net
AuthType Oblix
require valid-user
```

After you move the LocationMatch block to the VirtualHost directive, the Webgate will only work for that virtual host. You can add the LocationMatch block to as many virtual hosts as you want. The following examples shows how you could protect one virtual server:

```
ServerAdmin webmaster@example.net
DocumentRoot "Z:/Apps/Apache/htdocs/MYsrv"
ServerName apps.example.com
ProxyRequests On
```



```

SSLEngine on
SSLCACertificateFile Z:/Apps/sslcert_exampleapps_ptcweb32/intermediateca.cer
SSLCertificateFile Z:/Apps/sslcert_exampleapps_ptcweb32/
sslcert_myapps_ptcweb32.cer
SSLCertificateKeyFile Z:/Apps/sslcert_exampleapps_ptcweb32/
sslcert_myapps_ptcweb32.key
ErrorLog logs/proxysitel_log
CustomLog logs/proxysitel_log common
ProxyPass /https://apps.example.com/
ProxyPassReverse /https://apps.example.com/
ProxyPass /bkcentral https://apps.example.com/bkcentral
ProxyPassReverse /bkcentral https://apps.example.com/bkcentral
ProxyPass /NR https://apps.example.com/NR
ProxyPassReverse /NR https://apps.example.com/NR

AuthType Oblix
require valid-user

**** BEGIN Oracle Access Manager Webgate Specific ****

LoadModule obWebgateModule Z:/apps/Oracle/WebComponent/access/oblix/apps/webgate/bin/
webgate.dll
WebgateInstalldir Z:/apps/Oracle/WebComponent/access
WebgateMode PEER

SetHandler obwebgateerr

SSLMutex sem
SSLRandomSeed startup builtin
SSLSessionCache none

SSLLog logs/SSL.log
SSLLogLevel info
# You can later change "info" to "warn" if everything is OK

```

22.4.3 Host Identifier Page

A host identifier is automatically created when an Agent (and application) are registered using either the Oracle Access Management Console or the remote registration tool. In the Application Domain that is registered with the Agent, the host identifier is used automatically.

Administrators can use the console to create and manage host identifiers. Within the Oracle Access Management Console, host identifiers are organized under Shared Components, on the Policy Configuration tab navigation tree. Administrators can manually create a new host identifier definition, modify a definition, delete a definition, or copy an existing definition to use as a template. The name of the copy is based on the original definition name. For example, if you copy a definition named *host3*, the copy is named *copy of host3*.

[Figure 22-4](#) illustrates the Create Host Identifier configuration page in the console, where you enter the canonical name for the host, and every other name by which the same host can be addressed by users.

Note:

Each host identifier must be unique. You cannot use the same host name and port in any other host identifier definition.

Figure 22-4 Create Host Identifier Page

Table 22-4 describes the host identifier definitions.

Table 22-4 Host Identifier Definitions

Property	Description
Name	A unique name for this definition. Use only upper- and lower-case alpha characters. No punctuation or special characters are allowed.
Description	The optional description, up to 200 characters, that explains the use of this configuration.
Host Name Variations	<ul style="list-style-type: none"> Host Name: A list of the various host names or permutations that users might use when accessing the application. See also: "Host Identifier Variations" and "Host Identifier Guidelines". Port: The Web server port used by each host or permutation

22.4.4 Creating a Host Identifier

Users with valid Administrator credentials can create a host identifier definition manually. This is needed if an application and resources were manually added to a host that has no mapped host identifier. When you choose Auto Create Policies when registering an Agent, this is done automatically.

If you copy an existing definition to use as a template, you must modify all unique identifiers in the copy.

See Also:

- "[About Host Identifiers](#)"
 - "[About Virtual Web Hosting](#)"
-
-

1. In the Oracle Access Management Console, click **Application Security** at the top of the window.
2. In the Application Security console, click **Host Identifiers** in the Access Manager section.
3. Click **Create Host Identifier**.
4. On the Create Host Identifier page, fill in the:

- a. **Name**
 - b. **Description**
 - c. **Host Name Variations:** Add (or remove) host name and port variations in the Operations list.
Add: Click the **Add (+)** button, then enter a new host name and port combination to identify variables that map to the Host Identifier Name.
Remove: Click a host name, then click the **Delete** button to remove it.
5. Repeat step 3c as needed to identify all variations of this host that users can access.
 6. Click **Apply** to submit the new definition (or close the page without applying changes).
 7. Close the Confirmation window, and confirm the new definition is listed in the results table.

22.4.5 Searching for a Host Identifier Definition

Users with valid Administrator credentials can search for a specific host identifier.

Note:

During Delete, if the Host Identifier is associated with a resource, you are prompted with an alert. Without any association, the Host Identifier is deleted successfully.

See Also:

["SSO Agent Search Page"](#)

1. In the Oracle Access Management Console, click **Application Security** at the top of the window.
2. In the Application Security console, click **Host Identifiers** in the Access Manager section.
3. In the Search Host Identifiers page **Name** field, enter a name (or a partial name with wild card (*)), or leave the Name field blank to show all Host Identifiers. For example:
*my_h**
4. Click the **Search** button to initiate the search and display results in a table, then:
 - **View or Edit:** Double-click the name in the Search Results table to display the configuration page, then add or edit as usual.
 - **Delete:** Click the Delete button in the tool bar to remove the selected item in the results table; confirm removal in the Confirmation window.
 - **Detach:** Click Detach in the tool bar to expand the Search Results table to a full page (or from the View menu, click Detach).

- **Reorder Columns:** From the View menu, select reorder Columns and use the arrows provided to reorder the columns.

22.4.6 Viewing or Editing a Host Identifier Definition

Users with valid Administrator credentials can modify a host identifier definition.

This can include adding, changing, or removing individual host identifiers from the definition. For instance, when adding another proxy Web server with a different host name, you might need to modify an existing host identifier definition to add the new host name variation.

Prerequisite: Inventory Application Domains that refer to the host identifier and

Note:

After viewing settings, you can either close the page or modify settings as needed.

See Also:

["Host Identifier Page"](#)

1. Locate the desired host identifier and view it as described in "[Searching for a Host Identifier Definition](#)".
2. On the Host Identifier page, modify information as needed ([Table 22-4](#)):
 - a. **Name**
 - b. **Description**
 - c. **Host Name Variations:** In the table provided:

Add (+) Host Name Variations: Click the Add (+) button, then enter a new host name and port combination to identify variables that map to the Host Identifier Name.

Delete (X) Host Name Variations: Click a host name, then click the Delete button to remove it.
3. Repeat step 3c as needed to add or remove variations.
4. Click **Apply** to submit the changes (or close the page without applying changes).
5. Dismiss the Confirmation window, and close the page when you finish.

22.4.7 Deleting a Host Identifier Definition

Users with valid Administrator credentials can delete an entire host identifier definition. A validation error occurs if you attempt to delete the host identifier that is being used in a resource.

If the Host Identifier is associated with a resource, you are alerted. Without any association, the Host Identifier is deleted.

Prerequisites

Each resource in an Application Domain is associated with a specific host identifier. If you intend to delete a host identifier you must first modify any resource definitions in an Application Domain that uses this host identifier.

See Also:

["Viewing or Editing a Host Identifier Definition"](#) if you want to remove a single host identifier from an existing definition.

1. Locate and modify related resource definitions in any application domains that uses this host identifier. See ["Searching for a Resource Definition"](#).
2. Locate the desired host identifier as described in ["Searching for a Host Identifier Definition"](#).
3. **View:** Double-click the name in the results table to display the configuration page, and confirm this can be removed.
4. **Delete:** Click the Delete button in the tool bar to remove the selected item in the results table; confirm removal in the Confirmation window.

22.5 Understanding Authentication Methods and Credential Collectors

With Access Manager, authentication involves redirecting the requester (user) to a centralized component that performs authentication (known as the Credential Collector).

This section provides the following topics:

- [Authentication Methods Supported by Access Manager](#)
- [Embedded Credential Collector Versus Detached Credential Collector](#)
- [Authentication Event Logging and Auditing](#)

22.5.1 Authentication Methods Supported by Access Manager

Authentication is the process of proving that a user is who he or she claims to be. Authenticating a user's identity with Access Manager refers to running a pre-defined set of processes to verify the digital identity of the user. Using Access Manager, a resource or group of resources can be protected by a single authentication process known as an authentication scheme. Authentication schemes rely on pre-defined authentication modules or plug-ins.

This section describes multi-level authentication and other authentication methods supported by Access Manager.

Multi-level Authentication

Access Manager enables Administrators to assign different authentication levels to different authentication schemes, and then choose which scheme protects which application. Every authentication scheme requires a strength level. The lower this number, the less stringent the scheme. A higher level number indicates a more secure authentication mechanism.

SSO capability enables users to access more than one protected resource or application with a single sign in. A user who is authenticated to access resources at level 2, is

eligible to access resources protected at levels less than or equal to 2. However, if the user is authenticated to access resources at level 2 and then attempts to access resources protected by level 3, the user is asked to re-authenticate (this is known as step-up authentication).

For more information, see "[About Multi-Level and Step-Up Authentication](#)".

See Also:

["Multi-Step Authentication"](#)

Multi-Step Authentication

Multi-step authentication requires a custom authentication module composed of two or more authentication plug-ins that transmit information to the backend authentication scheme several times during the login process. All information collected by the plug-in and saved in the context will be available to the plug-in through the authentication process. Context data can also be used to set cookies or headers in the user's login page.

See "[Simple Form Versus Multi-Factor \(Multi-Step\) Authentication](#)".

Windows Native Authentication

Integrated Windows Native Authentication is supported for both OSSO and Webgate protected applications. This form of authentication relies on the Kerberos authentication module. For more information, see [Configuring Access Manager for Windows Native Authentication](#).

Other Authentication Types

Authentication features required by Oracle Fusion Middleware applications are supported, including:

- Weak authentication, typically a user name and password, no certificates
- Auto-login with third-party self-service user provisioning
- HTTP header support for user context information. For instance, host identifiers are used to create a host context for the resource. This is useful when adding resources that have the same URL paths on different computers.

If you use different authentication schemes for two WebGates, users can go from a higher authentication scheme to a lower one without re-authentication, but not from a lower level to a higher level.

Note:

During single sign-on, users might pass the authentication tests but might fail authorization tests when attempting to access a second or third resource. Each resource in the domain might have a unique authorization policy.

For details about configuring and using authentication schemes with Access Manager, see "[Managing Authentication Schemes](#)".

22.5.2 Embedded Credential Collector Versus Detached Credential Collector

Access Manager 11.1.2 supports the embedded credential collector (ECC) by default but also enables you to configure the latest WebGate to use as a detached credential collector (DCC, also known as an Authenticating WebGate). The DCC is considered more secure than the default ECC. The centralized DCC presents the login page, collects the user credentials (userID and password, for example), and sends these to the OAM Server using the back channel Oracle Access Protocol (OAP). Additional credentials can be requested using the DCC.

Note:

The DCC is the recommended approach for credential collection. See [Understanding Credential Collection and Login](#) for more details.

When OAM Server is configured to use the DCC, the ECC and its HTTP endpoints are disabled. The only HTTP communication is to the Oracle Access Management Console hosted by the WebLogic AdminServer in the domain where the OAM Server is deployed. Connectivity to the AdminServer can be controlled at the network level, for example, to disallow administration requests from outside the internal network.

- Allowing both the ECC and DCC to co-exist enables you to use authentication schemes and policies configured for use with either the ECC or the DCC. This enables a fallback mechanism for resources that rely on the ECC, which includes the Oracle Access Management Console.
- Disabling (turning off) the ECC entirely prohibits access to resources that rely on the ECC mechanism, including the Oracle Access Management Console.

While the embedded and detached credential collectors (ECC and DCC, respectively) are essentially the same, compare the two in [Table 22-5](#).

See Also:

["Understanding Credential Collection and Login "](#)

Table 22-5 Comparing the DCC and ECC

Feature	DCC	ECC
Deployment	<p>The Detached Credential Collector remains a logical part of the server and acts as a front channel communication endpoint of the OAM Server. However, the DCC also:</p> <ul style="list-style-type: none"> • Stands alone (detached from the OAM Server and does not require an application server). • Supports RSA SecurID passcode verification, get next token, create new pin workflows. • Is similar to the Authenticating Webgate with greater flexibility for server scale-out and attack resilience as well as credential collection UI construction, flow, and lifecycle management. 	<p>The Embedded Credential Collector is deployed with, and integral to, the OAM Server and part of the protocol binding layer.</p> <p>The ECC supports RSA SecurID passcode verification, get next token, create new pin workflows.</p>
DMZ Deployment	<p>Yes.</p> <p>The main benefit of a deployment using DCC in the DMZ is the termination of the end-user network connections within the public network, and the use of Oracle Access Protocol (Oracle's proprietary application network protocol) over mutually authenticated connections reaching the OAM Server. This offers a complete isolation of the OAM Server from the establishment of any unauthenticated network connection.</p> <p>Unauthenticated users cannot send malformed requests to the OAM Server.</p>	<p>No.</p>
Communication channel	<p>DCC consumes HTTP/HTTPS requests from the user, then communicates with the OAM Server across the Oracle Access Protocol (back channel), which can be SSL-enabled.</p>	<p>ECC communicates with both the user and the OAM Server across HTTP/HTTPS.</p>

Table 22-5 (Cont.) Comparing the DCC and ECC

Feature	DCC	ECC
DCC login, error, and password pages	<p>Dynamic pages general login/logout and password policy with the DCC are excluded automatically through the OHS httpd.conf/webgate.conf file--you do not need to configure a policy to exclude these. See the Webgate host in \$WEBGATE_HOME/webgate/ohs/oamssso/*, \$WEBGATE_HOME/webgate/ohs/oamssso-bin/*pl, and \$WEBGATE_HOME/webgate/ohs/oamssso-bin/templates/* directory:</p> <ul style="list-style-type: none"> • Login page: /oamssso-bin/login.pl • Logout: /oamssso-bin/logout.pl • RSA SecurID login pages: /oamssso-bin/securid.pl <p>Note: Update the Perl location in the first line of the login, logout, and securid scripts in /oamssso-bin.</p> <hr/> <p>See Also:</p> <ul style="list-style-type: none"> • Integrating RSA SecurID Authentication with Access Manager • Developing Custom Pages in <i>Fusion Middleware Developer's Guide for Oracle Access Management</i>. 	<p>Pages where the user enters her credentials arrive out of the box on the OAM Server and require no additional settings or changes.</p> <ul style="list-style-type: none"> • Login page: /pages/login.jsp • Logout page: /pages/logout.jsp • Error page: /pages/servererror.jsp • Multi-step: /pages/mfa_login.jsp
Perl Scripts for DCC-based Login and Logout	<p>Perl Scripts for DCC-based Login and Logout</p> <p>The path name of the Perl executable must be updated in Oracle-provided Perl scripts on the Webgate host \$WEBGATE_HOME/webgate/ohs/oamssso-bin/*pl to be consistent with the actual location.</p> <p>Unix: The which command finds Perl on the OAM Server. For example:</p> <pre>which perl /usr/bin/perl</pre> <p>However, Perl scripts themselves point to:</p> <pre>/usr/local/bin/perl</pre> <p>Windows: The default Perl Interpreter specified in Oracle-provided Perl scripts will not be available. You must update the Perl Interpreter path in these scripts to actual path to Perl on your system.</p>	N/A
Password policy enforcement	<p>Yes.</p> <p>See Configuring 11g WebGate and Authentication Policy for DCC</p>	<p>Yes</p> <p>See: Managing Global Password Policy</p>

Table 22-5 (Cont.) Comparing the DCC and ECC

Feature	DCC	ECC
Authentication scheme collection methods	DCC supports only Form Based Authentication.	ECC supports all challenge methods. The ECC collects user credentials based on the challenge method of the Authentication Scheme and sends it back to OAM Server for validation.
Custom Authentication Plugins and Challenge Methods	Yes; same as ECC.	All challenge methods and multi-step authentication (Password Policy and other custom authentication plugins) are supported.
Single Step (Simple Form) Authentication	Yes; same as ECC.	Yes. Both the DCC and ECC handle this, where: <ul style="list-style-type: none"> • All credentials are supplied in one simple form • Upon credential validation and authentication, either success or failure status is returned • This can be retried upon failure

Table 22-5 (Cont.) Comparing the DCC and ECC

Feature	DCC	ECC
Multi-Step Authentication	<p data-bbox="349 317 1242 380">Yes. Both the DCC and ECC handle complex multi-factor (multi-step, iterative, and variable) Authentication processing.</p> <p data-bbox="349 380 1242 411">In this case:</p> <ul data-bbox="349 411 1242 632" style="list-style-type: none"> <li data-bbox="349 411 1242 443">• Not all required credentials are supplied at once <li data-bbox="349 443 1242 537">• Depending on the authentication status, PENDING state, expected credentials and context data are returned, expecting those credentials to be supplied in the next round <li data-bbox="349 537 1242 600">• Each intermediate step, submit required credentials and context data to feed authentication engine, until a success or failure status returned <li data-bbox="349 600 1242 632">• The Authentication plug-in can have multiple steps configured <p data-bbox="349 632 1242 667">See "Understanding Multi-Level and Step-Up Authentication"</p>	<p data-bbox="1242 317 1453 579">Yes. Both the DCC and ECC handle complex multi-factor (multi-step, iterative, and variable) Authentication processing.</p>

Table 22-5 (Cont.) Comparing the DCC and ECC

Feature	DCC	ECC
Authentication Processing	<p>The DCC does not restrict authentication functionality of the OAM Server in any way as compared to the ECC.</p> <p>The DCC:</p> <ol style="list-style-type: none"> 1. Handles authentication redirects from 11g Webgates. 2. Handles Form-based authentication, which consists of a challenge to the user for their credentials (simple form or multi-factor). 3. Decrypts the authentication request message from the agent using the agent key; performs basic integrity checks; validates request time; and extracts all parameters from the request including request context. 4. Constructs the authentication response message, including request context originally retrieved, encrypts obrar using the agent key. 5. Decrypts the logout redirect request using the agent key to trigger logout processing. 	<p>During authentication:</p> <ol style="list-style-type: none"> 1. The ECC handles the request coming to the protocol binding layer (PBL), which converts it and sends it to the SSO Engine. 2. The SSO Engine checks for a valid session and, if none, transfers control to the Authentication Engine. 3. The Authentication Engine checks for resource protection and fetches the authentication scheme associated with the resource. 4. The ECC interacts with the client, accepts the data, and submits this to the PBL.

Table 22-5 (Cont.) Comparing the DCC and ECC

Feature	DCC	ECC
Overriding the ECC	<p>To deploy the DCC and override the ECC, an Administrator must perform the following tasks to specify the relevant DCC URLs and forms.</p> <ul style="list-style-type: none"> • OAM Agent registration: Allow Credential Collector Operations (enable for DCC) • Authentication Module, Step Orchestration: Error (if Failure) • Authentication Scheme: Challenge Redirect URL (DCC host and port) • Authentication Scheme: Challenge URL /oamssso-bin/login.pl (DCC login pages) • Authentication Scheme: Challenge Method • Password Policy: Password Service URL for DCC (Default: /oamssso-bin/login.pl) <p>See Configuring 11g WebGate and Authentication Policy for DCC</p>	N/A
Logout Configuration	See "Configuring Logout When Using Detached Credential Collector-Enabled WebGate"	See "Configuring Centralized Logout for 11g WebGates"
Cookie /Token	<ul style="list-style-type: none"> • DCCctxCookie • 11g WebGate: OAMAuthnCookie • 11g WebGate: OAMRequestContext • <p>See: "Single Sign-On Cookies During User Login"</p>	<ul style="list-style-type: none"> • 11g Webgate: OAMAuthnCookie • 11g Webgate: OAM_REQ • 11g Webgate: OAM_ID • 11g Webgate: OAMRequestContext • <p>See: "Single Sign-On Cookies During User Login"</p>

22.5.3 Authentication Event Logging and Auditing

Authentication Success and Failure events are audited, in addition to administration events. Auditing covers creating, modifying, viewing, and deleting authentication schemes, modules, and policies.

Information that is collected about the user who is authenticating includes:

- IP address
- User Login ID
- Time of Access

During logging (or auditing), user information, user sensitive attributes are not recorded. Secure data (user passwords, for example) are removed to avoid misuse.

See Also:

- [Logging Component Event Messages](#)
 - [Auditing Administrative and Run-time Events.](#)
 - [Monitoring Oracle Access Management Performance and Access Manager Health](#)
-
-

22.6 Managing Native Authentication Modules

In Access Manager, each authentication scheme requires an authentication module.

Native authentication modules lack the flexibility to orchestrate two or more plug-ins to meet specialized authentication needs. Therefore, native authentication modules are targeted for deprecation in future releases. Oracle strongly recommends using plug-in based authentication modules as described "[Orchestrating Multi-Step Authentication with Plug-in Based Modules](#)".

This section provides the following information:

- [Native Access Manager Authentication Modules](#)
- [Viewing or Editing Native Authentication Modules](#)
- [Deleting a Native Authentication Module](#)

22.6.1 Native Access Manager Authentication Modules

Native Access Manager Authentication Modules include LDAP, LDAPNoPasswordAuthModule, Kerberos, X509, and, Custom Authentication Modules.

"[Table 22-6](#)" lists the Native Access Manager Authentication Modules and description.

Table 22-6 Native Authentication Modules

Module Name	Description
LDAP	Matches the credentials (username and password) of the user who requests a resource to a user definition stored in an LDAP directory server. An LDAP module is required for Basic and Form challenge methods. See Also: " Native LDAP Authentication Modules ".
LDAPNoPasswordAuthModule	Matches the credentials (username and password) of the user who requests a resource to a user definition stored in an LDAP directory server. An LDAP module is required for Basic and Form challenge methods. See Also: " Native LDAP Authentication Modules ".
Kerberos	Identifies the key tab file and krb5.configuration file names and Principal. Use this plug-in when configuring Access Manager for Windows Native Authentication, as described in Configuring Access Manager for Windows Native Authentication . See Also: " Native Kerberos Authentication Module ".

Table 22-6 (Cont.) Native Authentication Modules

Module Name	Description
X509	Similar to the LDAPPlugin with additional properties that indicate which attribute of the client's X.509 certificate should be validated against the user attribute in LDAP. See Also: " Native X.509 Authentication Module ".
Custom Authentication Modules	This type of module relies on bundled plug-ins (or those that are developed using the Access Manager Authentication Extensibility Java API). This type of module generally uses more than one plug-in that you can orchestrate to ensure that each one performs a specific authentication function. Depending on the success or failure action defined for each plug-in, another authentication plug-in is called. See Also: " Pre-populated Plug-ins for Configuring Access Manager with Multi-Step Authentication ", and <i>Oracle Fusion Middleware Developer's Guide for Oracle Access Management</i> for details about developing and deploying plug-ins, custom authentication modules, and schemes that use custom modules.

See Also:

- "[Credential Challenge Methods](#)"
- *Oracle Fusion Middleware Developer's Guide for Oracle Access Management* for details about creating custom authentication plug-ins

22.6.1.1 Native Kerberos Authentication Module

The pre-configured Kerberos authentication module is illustrated in [Figure 22-5](#). Additional details follow the figure.

Figure 22-5 Native Kerberos Authentication Module

Access Manager >

Kerberos Kerberos Authentication Module Duplicate Apply

Use this Authentication Module when configuring Access Manager for Windows Native Authentication. It identifies the key tab file and krb5 configuration file names and Principal.

* Name

* Key Tab File

* Principal

* KRB Config File

[Table 22-7](#) describes the definition of the native Kerberos authentication module. You can use the existing, pre-configured Kerberos authentication module or create one of your own.

Table 22-7 Native Kerberos Authentication Module Definition

Element	Description
Name	The unique ID of this module, which can include upper and lower case alpha characters as well as numbers and spaces.

Table 22-7 (Cont.) Native Kerberos Authentication Module Definition

Element	Description
Key Tab File	<p>The path to the encrypted, local, on-disk copy of the host's key, required to authenticate to the key distribution center (KDC). For example: /etc/krb5.keytab.</p> <p>The KDC authenticates the requesting user and confirms that the user is authorized for access to the requested service. If the authenticated user meets all prescribed conditions, the KDC issues a ticket permitting access based on a server key. The client receives the ticket and submits it to the appropriate server. The server can verify the submitted ticket and grant access to the user submitting it.</p> <p>The key tab file should be readable only by root, and should exist only on the machine's local disk. It should not be part of any backup, unless access to the backup data is secured as tightly as access to the machine's root password itself.</p>
Principal	Identifies the HTTP host for the principal in the Kerberos database, which enables generation of a keytab for a host.
KRB Config File	<p>Identifies the path to the configuration file that controls certain aspects of the Kerberos installation. A krb5.conf file must exist in the /etc directory on each UNIX node that is running Kerberos.</p> <p>krb5.conf contains configuration information required by the Kerberos V5 library (the default Kerberos realm and the location of the Kerberos key distribution centers for known realms).</p>

22.6.1.2 Native LDAP Authentication Modules

Oracle provides two LDAP authentication modules: LDAP and LDAPNoPasswordAuthModule.

Both modules have the same requirements (Name and User Identity Store), as illustrated in [Figure 22-6](#). Additional details follow the figure.

Figure 22-6 Native LDAP Authentication Module

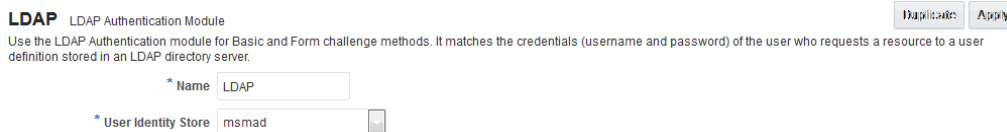

[Table 22-8](#) describes the elements in an LDAP authentication module. The same elements and values are also used in LDAPNoPasswordAuthnModule.

Note:

These standard LDAP Authentication Modules are targeted for deprecation. Future enhancements will not be available in standard modules. Oracle strongly recommends using plug-in based modules.

Table 22-8 Native LDAP Authentication Modules Definition

Element	Description
Name	A unique name for this module.
User Identity Store	<p>The designated LDAP user identity store must contain any user credentials required for authentication by this module. The LDAP store must be registered with Access Manager.</p> <p>See Also: "Registering and Managing User Identity Stores".</p> <p>Multiple identity store vendors are supported. Upon installation, there is only one User Identity Store, which is also the designated System Store. If you add more identity stores and designate a different store as the System Store, be sure to change the LDAP module to point to the System Store. The authentication scheme <code>OAMAdminConsoleScheme</code> relies on the LDAP module for Administrator Roles and credentials.</p> <p>See Also: "About using the System Store for User Identities" and "Administrator Lockout".</p>

22.6.1.3 Native X.509 Authentication Module

Access Manager provides a pre-configured X.509 authentication module as a default. Administrators can also create new X.509 authentication modules. In cryptographic terms, X.509 is a standard for digital public key certificates used for single sign-on (SSO). X.509 specifies standard formats for public key certificates, certificate revocation lists, and attribute certificates among other things.

With X.509 digital certificates you can assume a strict hierarchical system of certificate authorities (CAs) issuing the certificates. In the X.509 system, a CA issues a certificate that binds a public key to a particular Distinguished Name, or to an Alternative Name such as an e-mail address or a DNS-entry.

The trusted root certificates of an enterprise can be distributed to all employees so that they can use the company PKI system. Certain Web browsers provide pre-installed root certificates to ensure that SSL certificates work immediately.

Access Manager uses the Online Certificate Status Protocol (OCSP) Internet protocol to maintain the security of a server and other network resources. OCSP is used for obtaining the revocation status of an X.509 digital certificate. OCSP specifies the communication syntax used between the server containing the certificate status and the client application that is informed of that status.

When a user attempts to access a server, OCSP sends a request for certificate status information. OCSP discloses to the requester that a particular network host used a particular certificate at a particular time. The server returns a response of "current", "expired," or "unknown." OCSP allows users with expired certificates a configurable grace period, during which they can access servers for the specified period before renewing.

OCSP messages are encoded in ASN.1 and are usually transmitted over HTTP. The request and response characteristic of OCSP has led to the term "OCSP responders" when referring to OCSP servers. With Access Manager, the computer hosting the Oracle Access Management Console is the OCSP responder.

An OCSP responder can return a signed response signifying that the certificate specified in the request is 'good', 'revoked' or 'unknown'. If OCSP cannot process the request, it can return an error code.

Figure 22-7 Native X.509 Authentication Module

X509 X509 Authentication Module Duplicate Apply

X509 Authentication Module indicate which attribute of the client's X.509 certificate should be validated against the user attribute in LDAP.

* Name

* Match LDAP Attribute

* X509 Cert Attribute

* Cert Validation Enabled

* OSCP Enabled

OCSP Server Alias

OCSP Responder URL

OCSP Responder Timeout ^ v

Table 22-9 describes the requirements of the native X.509 authentication module.

Note:

This standard Authentication Module is targeted for deprecation. Future enhancements will not be available in standard modules. Oracle strongly recommends using plug-in based modules.

Table 22-9 X509 Authentication Module Definition

Element	Description
Name	Identifies this module definition with a unique name.
Match LDAP Attribute	<p>Defines the LDAP distinguished name attribute to be searched against given the X509 Cert Attribute value.</p> <p>For example, if the certificate subject EMAIL is me@example.com and it must be matched against the "mail" LDAP Attribute, an LDAP query must search LDAP against the "mail" attribute with a value "me@example.com (cn).</p> <p>Default: cn</p>
X509 Cert Attribute	<p>Defines the certificate attribute to be used to bind the public key (attributes within subject, issuer scope to be extracted from the certificate: subject.DN, issuer.DN, subject.EMAIL, for example).</p> <p>See Also. Match LDAP Attribute earlier in this table.</p>
Cert Validation Enabled	<p>Enables (or disables if not checked) X.509 Certificate validation.</p> <p>When enabled, the OAM Server performs the certificate validation (rather than having the WebLogic server intercept and validate the certificate before passing it to the OAM Server). Access Manager performs the entire certificate path validation.</p>
OCSP Enabled	<p>Enables (or disables when not checked) the Online Certificate Status Protocol. Values are either true or false. For example:</p> <p>OCSP Enabled: true</p> <p>Note: OCSP Server Alias, OCSP Responder URL and OCSP Responder Timeout are required only when OCSP Enabled is selected.</p>

Table 22-9 (Cont.) X509 Authentication Module Definition

Element	Description
OCSP Server Alias	An aliased name for the OSCSP Responder pointing to CA certificates in .oamkeystore file--a mapping between the aliased name and the actual instance name or the IP address of the OSCSP Responder instance.
OCSP Responder URL	Provides the URL of the Online Certificate Status Protocol responder. For example, OpenSSL Responder URL: <code>http://localhost:6060</code>
OCSP Responder Timeout	Specifies the grace period for users with expired certificates, which enables them to access OAM Servers for a limited time before renewing the certificate.

22.6.2 Viewing or Editing Native Authentication Modules

Users with valid Administrator credentials can modify an existing authentication module.

This includes changing the name of an existing module as well as changing other attributes.

Prerequisites

Modify each authentication scheme that references the module you will change, to use another authentication module if needed.

Note:

By default, the LDAP module is used in the authentication scheme that protects the Oracle Access Management Console. To ensure Administrator access, the LDAP module must point to the User Identity Store that is designated as the System Store. If you change the designated System Store, be sure to change the LDAP Module to reference the newly designated System Store.

1. In the Oracle Access Management Console, click **Application Security** at the top of the window.
2. In the Application Security console, click **Authentication Modules** in the **Plug-ins** section.
3. In the Search Results list, select the desired module to open its properties page.
4. On the properties page, modify information as needed:
 - Kerberos Module: See [Table 22-7](#)
 - LDAP Module: See [Table 22-8](#)
 - X.509 Module: See [Table 22-9](#) and [Table 22-15](#)
5. Click **Apply** to submit the changes and close the Confirmation window (or close the page without applying changes).

6. Add the updated authentication module to authentication schemes (or change to another authentication module in each authentication scheme that references this module), as described in "[Managing Authentication Schemes](#)".

22.6.3 Deleting a Native Authentication Module

Users with valid Administrator credentials can use the following procedure to delete an authentication module.

The following procedure is the same whether you are deleting a custom authentication module or a native module.

Prerequisites

In each authentication scheme that references the module to be deleted, specify another authentication module.

1. In the Oracle Access Management Console, click **Application Security** at the top of the window.
2. In the Application Security console, click **Authentication Modules** in the **Plug-ins** section.
3. Optional: Open the module to verify this is the module to remove, then close the page.
4. In the Search Results list, click the desired module name, then click the **Delete** button.
5. Confirm removal (or dismiss the confirmation window to retain the module).

22.7 Orchestrating Multi-Step Authentication with Plug-in Based Modules

Authentication involves determining which credentials a user must supply when requesting access to a resource, gathering credentials, and returning a response that is based on the results of credential validation. All authentication processing relies on an authentication module to define the rules governing requirements and transmission of information to the backend authentication scheme. All information collected by the plug-in and saved in the context is available to the plug-in through the authentication process.

Context data can also be used to set cookies or headers in the user's login page.

Note:

Oracle strongly recommends using authentication plug-ins to create custom authentication modules.

This section provides the following topics:

- [Simple Form Versus Multi-Factor \(Multi-Step\) Authentication](#)
- [Access Manager Plug-ins for Multi-Step Authentication Modules](#)
- [Pre-populated Plug-ins for Configuring Access Manager with Multi-Step Authentication](#)
- [Example: Leveraging SubjectAltName Extension Data and Integrating with Multiple OCSP Endpoints](#)

- [Creating a Custom Authentication Module using Bundled Plug-ins](#)
- [Steps and Plug-ins in Customized Step-up Authentication Module](#)
- [Configuring an HTTPToken Extractor Plug-in](#)
- [JSON Web Token Plug-in](#)

See Also:

Oracle Fusion Middleware Developer's Guide for Oracle Access Management if you want to create custom authentication plug-ins.

22.7.1 Simple Form Versus Multi-Factor (Multi-Step) Authentication

Simple form-based authentication is the default and does not require additional configuration unless you want to customize forms. Authentication plug-ins provide processing that meets your specific multi-step authentication needs.

Simple form-based authentication relies on the default embedded or optional detached credential collector and Web forms that process user logins with Access Manager authentication mechanisms. With simple form-based authentication:

- All credentials are supplied in one simple form.
- Upon credential validation and authentication, either success or failure status is returned.
- Authentication can be retried upon failure.

See Also:

Developing Custom Pages for details about customizing login pages and forms

For dynamic, multi-step authentication, Access Manager provides a number of plug-ins with which you can design and orchestrate your own customized authentication modules. Both the ECC and DCC handle complex multi-factor (multi-step, iterative, and variable) Authentication processing, where:

- Not all required credentials are supplied at once
- Depending on the authentication status, PENDING state, expected credentials and context data are returned, expecting those credentials to be supplied in the next round
- Each intermediate step, submit required credentials and context data for the authentication engine, until a success or failure status is returned.
- The Authentication plug-in can have multiple steps configured.

Note:

Administrators can install multiple user identity stores for Access Manager. Each identity store can rely on a different LDAP provider. Each authentication plug-in can be configured to use a different user identity store.

[Table 22-10](#) provides more information about these two forms of authentication.

Table 22-10 Simple Form versus Multi-Step Authentication

Authentication Method	Description
Simple form-based authentication	<p>Simple form-based authentication relies on Credential Collectors (both ECC and DCC) and Web forms that process user logins using Access Manager authentication mechanisms. This is the default and does not require additional configuration unless you want to customize forms.</p> <p>See Also: Developing Custom Pages for details about customizing login pages and forms</p>
Multi-Step Authentication	<p>Multi-step authentication requires a custom authentication module composed of two or more authentication plug-ins that transmit information to the backend authentication scheme several times during the login process. All information collected by the plug-in and saved in the context will be available to the plug-in through the authentication process. Context data can also be used to set cookies or headers in the user's login page.</p> <p>Multi-Step authentication relies on:</p> <ul style="list-style-type: none"> • Authentication Chaining: You can chain multiple authentication plug-ins in a new authentication module, and add the module to an authentication scheme. • Challenge Mechanism: Controls the way in which the required credentials are collected. Currently, this is tied to the authentication scheme. Both the ECC and DCC use the same challenge mechanisms. • Credential Collection: Either the ECC or DCC can be used for multi-step authentication. (DCC provides greater flexibility for interactions with users or programmatic entities when collecting authentication-related information that involves several methods to establish the user's identity). <p>See Also: Configuring 11g WebGate and Authentication Policy for DCC "Steps and Plug-ins in Customized Step-up Authentication Module" Developing Custom Authentication Plug-ins for details about custom authentication plug-ins</p>

22.7.2 Access Manager Plug-ins for Multi-Step Authentication Modules

Plug-ins operate with either the default embedded credential collector (ECC) or the optional detached credential collector (DCC-enabled WebGate). Each authentication plug-in provides an individual piece of functionality that you can use alone or string together into a series of steps. The lifecycle of a plug-in centers around the ability to add and use the plug-ins to build features and work flows that act as extensions to the

OAM Server. Each plug-in is deployed as a JAR file and each plug-in's configuration requirements must be given in XML format.

You can create custom plug-in based authentication modules using existing Access Manager. You can also create your own plug-ins, as described in the *Oracle Fusion Middleware Developer's Guide for Oracle Access Management*.

Note:

Standard (native) Authentication Modules are targeted for deprecation; future enhancements will not be available in the standard modules. Oracle strongly recommends using plug-in based modules as described in "[Orchestrating Multi-Step Authentication with Plug-in Based Modules](#)".

[Figure 22-8](#) shows plug-ins available out of the box. These plug-ins, and any that you create using the SDK and import, appear in a list when you add steps to build a custom authentication module.

Figure 22-8 Access Manager Plug-ins for Customized Authentication Modules

Row#	Plug-in Name	Description	Activation Status	Type
1	UserIdentificationPlugin		Activated	Authentication
2	UserAuthenticationPlugin		Activated	Authentication
3	UserPasswordPolicyPlugin		Activated	Authentication
4	UserForgotPasswordPlugin		Activated	Authentication
5	FedUserProvisioningPlugin		Activated	User Provisioning
6	TAPAssertionPlugin		Activated	Assertion
7	TAPIdentifyPlugin		Activated	Assertion
8	KerberosTokenIdentifier		Activated	Authentication
9	KerberosTokenAuthenticator		Activated	Authentication
10	MTModelIdentifierPlugin		Activated	Authentication
11	FedModelIdentifierPlugin		Activated	Authentication
12	SIMFedModelIdentifierPlugin		Activated	Authentication
13	BasicFedModelIdentifierPlugin		Activated	Authentication
14	SIMBasicFedModelIdentifierPlugin		Activated	Authentication
15	FedProgramaticAuthnPlugin		Activated	Authentication
16	X509CredentialExtractor		Activated	Authentication
17	TAPRequestPlugin		Activated	Authentication
18	TAPUserAuthenticationPlugin		Activated	Authentication
19	TenantDisambiguationPlugin		Activated	Authentication
20	FedAuthnRequestPlugin		Activated	Authentication
21	FedUserAuthenticationPlugin		Activated	Authentication
22	RSA SecurID Plugin		Activated	Authentication
23	HTTPTokenExtractor		Activated	Authentication
24	UserAuthnLevelCheckPlugin		Activated	Authentication
25	CredentialCollectorPlugin		Activated	Authentication
26	IPFUserPasswordPolicyPlugin		Activated	Authentication
27	PersistentLoginPlugin		Activated	Assertion
28	IPFUserForgotPasswordPlugin		Activated	Authentication
29	TOTPPlugin		Activated	Authentication
30	GenericStatePlugin		Activated	Authentication
31	EssoProvisioningPlugin		Activated	Authentication
32	FedAttributeRequestPlugin		Activated	Authentication
33	OAuthTokenResponsePlugin		Activated	Assertion
34	SFAPPlugin		Activated	Authentication
35	CredentialChallengePlugin		Activated	Authentication
36	TAPResponseValidationPlugin		Activated	Authentication

The Name generally defines the component that relies on the plug-in. The Description is optional. The Type column indicates the purpose of the plug-in. Activation Status lets you know if this is active and ready to use.

See Also:

Oracle Fusion Middleware Developer's Guide for Oracle Access Management for details about building your own custom plug-ins. You can import new plug-ins, distribute, activate, deactivate, and remove custom plug-ins.

Whether you use an Oracle-provided plug-in or create one of your own, adding a plug-in when you create a custom authentication module is the same. Each custom module requires the following types of information:

- **General** identifies the unique name and optional description for the individual plug-in.
- **Steps** identify the specific plug-ins to use, and their execution order, based on the configuration details of each plug-in (including the user identity store to use).
- **Step Orchestration** specifies the action to be taken on success or on failure or on error.

Note:

When multi-factor authentication is used, the `UserIdentificationPlugin` should be invoked in the last pass during the authentication process.

Figure 22-9 shows the Custom Authentication Module within the Access Manager section of the System Configuration tree. Each module has three configuration tabs.

Figure 22-9 Creating Custom Authentication Modules: General

Table 22-11 describes the content of the General tab.

Table 22-11 General tab

Element	Description
Name	A unique name up to 60 characters.
Description	Optional; up to 250 characters.

Clicking the Steps tab opens a fresh page where you can add a new step. When you add a new Step, the following dialog box appears. Information that you enter is used to populate the table and Details sections of the page.

Figure 22-10 Adding a Step and Associating a Plug-in

Table 22-12 describes the information required when adding a new step. Each step requires a plug-in and each plug-in requires specific details for proper operation.

Table 22-12 Add New Step Entries, Steps Results Table, and Details Section

Element	Description
Step Name	The unique name you enter to identify this step, up to 60 characters.
Description	The optional description for this step, as entered when adding the step (up to 250 characters).
Plug-in Name	The plug-in that you select for a particular step from the list of imported and activated plug-ins. See Also: <i>Oracle Fusion Middleware Developer's Guide for Oracle Access Management</i> for details about creating custom plug-ins.

Table 22-12 (Cont.) Add New Step Entries, Steps Results Table, and Details Section

Element	Description
Step Details	<p>Plug-in configuration details must be specified to ensure proper operation. Details might differ depending the chosen plug-in and its requirements.</p> <p>See Also: Table 22-13.</p>

[Table 22-13](#) describes the Plug-in Parameter Details required by Oracle-provided plug-ins. Absent from this table are the plug-in exceptions (those plug-ins with no initial parameters): `KerberosTokenIdentifier`, `FedAuthnRequestPlugin`, and `FedUserAuthenticationPlugin`.

Table 22-13 Parameter Details for Various Plug-ins

Plug-in Parameter	Display Name	Description
KEY_IDENTITY_STORE_REF	Identity Store Name	<p>Most plug-ins require this attribute to ensure that the appropriate user identity store is called during authentication.</p> <p>The following plug-in uses only this property:</p> <ul style="list-style-type: none"> • <code>TAPAssertionPlugIn</code> <p>For additional Details required by plug-ins that employ this property, see:</p> <ul style="list-style-type: none"> • <code>UserIdentificationPlugIn</code> • <code>UserAuthenticationPlugIn</code> • <code>UserPasswordPolicyPlugin</code> • <code>TAPUserAuthenticationPlugin</code> • <code>TenantDisambiguationPlugin</code>

Table 22-13 (Cont.) Parameter Details for Various Plug-ins

Plug-in Parameter	Display Name	Description
CredentialCollectorPlugIn	CredentialCollectorPlugIn	<p>This plugin allows the administrator to configure which credentials will be collected for authentication. Credentials to be collected are configured as step parameters. The plugin validates these parameters and renders the UI to collect the credentials. After user input, the plugin parses the credential parameters and builds the user context with credential objects.</p> <p>NOTE: Plugin error responses are set to the context if the credentials are invalid and the plugin returns failure.</p> <p>The plugin supports the collection of 4 credentials as step level parameters.</p> <ol style="list-style-type: none"> 1. CRED_PARAM_1 2. CRED_PARAM_2 3. CRED_PARAM_3 4. CRED_PARAM_4 <p>The following example illustrates how to collect a username and password.</p> <pre>CRED_PARAM_1= {ID=KEY_USERNAME}, {DISPLAY_NAME=KEY_USERNAME},{TYPE=text} {ID=KEY_PASSWORD}, {DISPLAY_NAME=KEY_PASSWORD},{TYPE=password}</pre> <p>Where ID, DISPLAY_NAME and TYPE are constants.</p>
Actiontype	Action Type	Indicates if the plugin wants to REDIRECT or FORWARD to the login page to collect credentials.
loginPageURL	Login Page URL	The URL to which the user will be forwarded or redirected for credential collection.
NO_OF_CREDENTIALS		The number of credentials provided for the plugin instance. If the number of instances is more than 4, the user must update the oam-config file to add additional CRED_PARAMS as plugin parameters.
UserIdentificationPlugIn	UserIdentificationPlugIn	This native plug-in maps the user to a specific LDAP user record.
KEY_LDAP_FILTER	LDAP Filter	The search filter required to identify the user. LDAP attributes are used when defining an LDAP search filter.

Table 22-13 (Cont.) Parameter Details for Various Plug-ins

Plug-in Parameter	Display Name	Description
KEY_SEARCHBASE_URL	LDAP Searchbase	The search base required for the query. The node in the directory information tree (DIT) under which user data is stored; the highest possible base for all user data searches.
UserAuthenticationPlugIn	UserAuthenticationPlugIn	This native plug-in authenticates the supplied username/password credentials against an LDAP directory.
KEY_PROP_AUTHN_EXCEPTION	Propagate LDAP errors	Enables (or disables) propagation of LDAP errors. UserAuthenticationPlugIn employs this attribute.
UserAuthnLevelCheckPlugIn	UserAuthnLevelCheckPlugIn	This native plug-in shall determine if the user has been authenticated to the authentication level X - where the value of X is provided by the plugin parameter AUTHN_LEVEL_FOR_PLUGIN. For example, it checks the current Authentication Level of the user with the value specified. In addition, the plug-in specifies a list of parameters to collect depending on whether the Authentication Level check succeeded or failed.
AUTHN_LEVEL_FOR_PLUGIN	AUTHN_LEVEL_FOR_PLUGIN	Specify the authentication level as an integer. Multiple steps can use UserAuthnLevelCheckPlugIn. However, each Step must have a unique name and AUTHN_LEVEL_FOR_PLUGIN. See Also: "Steps and Plug-ins in Customized Step-up Authentication Module"
UserPasswordPolicyPlugIn	UserPasswordPolicyPlugIn	
PLUGIN_EXECUTION_MODE	Mode of Operation	The execution mode of UserPasswordPolicyPlugIn. UserPasswordPolicyPlugIn is supported only when using LDAP based authentication modules. It does not work with non LDAP authentication modules. Depending upon the configuration, can operate either alone or with other default plug-ins. Values are one of the following: <ul style="list-style-type: none"> PSWDONLY: Default. The most preferred configuration where only the password status is determined. The ID and authentication must be performed using the UserIdentification and UserAuthentication Plugins. AUTHWITHPSWD: Both authentication and password are performed using this plug-in. AUTHONLY: Only the user identification and authentication is performed using this plug-in

Table 22-13 (Cont.) Parameter Details for Various Plug-ins

Plug-in Parameter	Display Name	Description
POLICY_SCHEMA	Policy Schema To Use	Specifies the schema for the password service (used with UserPasswordPolicyPlugin). Only OAM10G is supported. Default: OAM10G
NEW_USERPSWD_BEHAVIOR	Force Password Change on First Login	Configures retroactive behavior of the new-user password-policy. Used with UserPasswordPolicyPlugin. Values are either: <ul style="list-style-type: none"> FORCECHANGEPASSWORD: Forces a password change. NOFORCEPASSWORDCHANGE: The password policy change does not affect user passwords that are already set. Default: FORCECHANGEPASSWORD
DISABLED_STATUS_SUPPORT	Disabled Account Status Support	Specifies whether the disabled status is to be supported and acted upon in this password service. Valid values are either True or False. Default: TRUE
URL_ACTION	Password Management Action URL	Specifies the URL to which the user is sent for password management. The type of servlet action needed for redirecting the user to the specific password page for expiry and warning pages. Values can be either: <ul style="list-style-type: none"> REDIRECT_POST REDIRECT_GET FORWARD Default: REDIRECT_POST
FedUserProvisioningPlugin		
KEY_USER_RECORD_ATTRIBUTE_LIST	List of User Attributes	For Federation. Comma-separated list of assertion attributes required to create the user record.
KEY_PROVIDERID_ATTRIBUTE_NAME	Partner Attribute Name	For Federation. The attribute name of the LDAP user record whose value will be set to the Partner's Identity Provider ID when provisioning the user. This field is optional and if empty, the Partner's Identity Provider ID will not be set in the LDAP user record.
KEY_USERID_ATTRIBUTE_NAME	User UserID Attribute	For Federation. Name of the attribute in the assertion attributes that is used as the LDAP UserID.
TAPIdentifyPlugIn		
KEY_TAP_RETURN_ATTRIBUTE	Username Mapping Attribute	Name of the attribute used for account linking by TAPIdentifyPlugIn.
SequentialPlugInExecutionStrategy		

Table 22-13 (Cont.) Parameter Details for Various Plug-ins

Plug-in Parameter	Display Name	Description
StrategyName	Orchestration Strategy	Name of the plugin orchestration strategy required by SequentialPlugInExecutionStrategy.
KerberosTokenAuthenticator		
KEY_KEYTAB_FILE	Location of Keytab file	Name of the file containing Kerberos principals and encrypted keys required by KerberosTokenAuthenticator
KEY_PRINCIPAL	OAM Service Principal	Your OAM Account SPN, required by KerberosTokenAuthenticator.
KEY_KRB_CONFIG_FILE	Location of Kerberos Configuration file	Location of the Kerberos configuration properties file, required by KerberosTokenAuthenticator.
KEY_DOMAIN_DNS2DN_MAP	AD Domain DNS Names to DN Mapping	Comma-separated list of Active Directory DNS Domains to DN mappings required by KerberosTokenAuthenticator.
X509CredentialExtractor		
KEY_CERTIFICATE_ATTRIBUTE_TO_EXTRACT	User Mapping Attribute	X509 certificate Attribute to be used for user mapping required by X509CredentialExtractor.
KEY_IS_CERT_VALIDATION_ENABLED	Certificate Validation	Enable or disable X.509 certificate validation, required by X509CredentialExtractor.
TAPRequestPlugin		
TAPSPVersion	Integration Protocol Version	Token version for Integration.
TAPPartnerId	Integration PartnerId	Integration Partner Identifier.
TAPChallengeURL	Partner Integration Endpoint URL	Remote Partner End Point URL.
TAPUserAuthenticationPlugin		
KEY_USERNAME_ATTRIBUTE	Username Mapping Attribute	Name of the attribute used for account linking required by TAPUserAuthenticationPlugin
KEY_CHECK_TOKEN_EXPIRY	Enable Token Expiration Checking	Enable or disable Integration token expiration.
TenantDisambiguationPlugin		
KEY_FEDERATED_TENANTS	FederatedTenantNames	Optional names of tenants (comma separated) for whom federated authentication is enabled. Plugin will check with Federation engine if tenant names are not mentioned.
RSA SecurID Plugin		

Table 22-13 (Cont.) Parameter Details for Various Plug-ins

Plug-in Parameter	Display Name	Description
username	Username Parameter	Name of the username plugin parameter required by RSA SecurID Plugin.
passcode	Passcode Parameter	Name of the passcode plugin parameter required by RSA SecurID Plugin.
nexttoken	Next Token Parameter	Name of the next token plugin parameter required by RSA SecurID Plugin.
newpin	New PIN Parameter	Name of the new pin plugin parameter required by RSA SecurID Plugin.
confirmnewpin	Confirm New PIN Parameter	Name of the confirm new pin plugin parameter required by RSA SecurID Plugin.
HTTPTokenExtractor		
KEY_HEADER_PROPERTY	HTTP Header Names	Comma separated list of HTTP Headers. See Configuring an HTTPToken Extractor Plug-in .
KEY_COOKIE_PROPERTY	HTTP Cookie Names	Comma separated list of Cookies. See Configuring an HTTPToken Extractor Plug-in .

Figure 22-11 illustrates the Steps tab and Details section for a custom authentication module. When adding Steps, there is no data to display in the table. However, when you add one or more Steps to the table, the Details sections are populated.

Figure 22-11 Plug-in Based Authentication Module Steps and Details

The screenshot shows the 'Authentication Module' configuration page. At the top, there are 'Duplicate' and 'Apply' buttons. Below is a description: 'Custom Authentication Module relies on bundled plug-ins (or those that are developed using the Access Manager Authentication Extensibility Java API). This module uses more than one plug-in that you can orchestrate to ensure that each one performs a specific authentication function.' There are tabs for 'General', 'Steps', and 'Steps Orchestration'. The 'Steps' tab is active, showing a table with columns 'Step Name', 'Description', and 'Plug-in Name'. The table contains three rows: 'ESSO_UI_Step' with 'UserIdentificationPlugin', 'ESSO_UA_Step' with 'UserAuthenticationPlugin', and 'ESSO_PROV_Step' with 'EssoProvisioningPlugin'. Below the table are 'View', '+', 'x', and 'Detach' icons. The 'Step Details' section is expanded for 'ESSO_UI_Step', showing fields for 'Step Name', 'Description', and 'Plug-in Name'. Below this is the 'Plug-in Parameters' section with three input fields: 'KEY_IDENTITY_STORE_REF', 'KEY_LDAP_FILTER', and 'KEY_SEARCH_BASE_URL'. 'Save' and 'Cancel' buttons are at the bottom right.

Figure 22-12 illustrates the Steps Orchestration tab of a custom authentication module, which is populated by information for each defined step (and the action you choose for each operational condition).

Figure 22-12 Steps Orchestration for Plug-in Based Authentication Modules

Authentication Module Authentication Module Duplicate Apply

Custom Authentication Module relies on bundled plug-ins (or those that are developed using the Access Manager Authentication Extensibility Java API). This module uses more than one plug-in that you can orchestrate to ensure that each one performs a specific authentication function.

General Steps **Steps Orchestration**

You can specify the initial step

* Initial Step

Name	Description	On Success	On Failure	On Error
ESSO_UI_Step		<input type="text" value="ESSO_UA_Step"/>	<input type="text" value="failure"/>	<input type="text" value="failure"/>
ESSO_UA_Step		<input type="text" value="ESSO_PROV_Step"/>	<input type="text" value="failure"/>	<input type="text" value="failure"/>
ESSO_PROV_Step		<input type="text" value="success"/>	<input type="text" value="failure"/>	<input type="text" value="failure"/>

Table 22-14 describes the elements on the Steps Orchestration tab. The lists available for OnSuccess, OnFailure, and OnError include the following choices:

- success
- failure
- *StepName* (any step in the module can be selected as the action for an operational condition)

Table 22-14 Steps Orchestration Tab

Element	Description
Initial Step	Choose the starting step from those listed. The list includes only those steps defined for this module.
Name	Each step added to this module is listed by the name that was entered when the step was added.
Description	The optional description for this step, entered when this step was added.
OnSuccess	The action selected for successful operation. A list provides actions you can choose: <ul style="list-style-type: none"> • Success • Failure • <i>StepName</i> (activates the next step)
OnFailure	The action selected for failure of this step. A list provides actions you can choose: <ul style="list-style-type: none"> • Success • Failure • <i>StepName</i> (activates the next step)
OnError	The action selected for an error when executing this step. A list provides actions you can choose: <ul style="list-style-type: none"> • Success • Failure • <i>StepName</i> (activates the next step)

22.7.3 Pre-populated Plug-ins for Configuring Access Manager with Multi-Step Authentication

The following topics describe several of the native Custom modules provided with pre-populated plug-ins. You can use these to orchestrate your own custom authentication modules:

- [KerberosPlugin](#)
- [LDAPPlugin](#)
- [X509Plugin](#)
- [Password Policy Validation Module and Plug-ins](#)

See Also:

- [Table 22-13](#)
 - [Example: Leveraging SubjectAltName Extension Data and Integrating with Multiple OCSP Endpoints](#)
 - ["Steps and Plug-ins in Customized Step-up Authentication Module"](#)
-

KerberosPlugin

Use this plug-in when configuring Access Manager for Windows Native Authentication, as described in [Configuring Access Manager for Windows Native Authentication](#).

[Figure 22-13](#) shows the KerberosPlugin module that is bundled with Access Manager 11g. This is a credential mapping module that matches the credentials (username and password) of the user who requests a resource to the encrypted "kerberos ticket".

Figure 22-13 KerberosPlugin

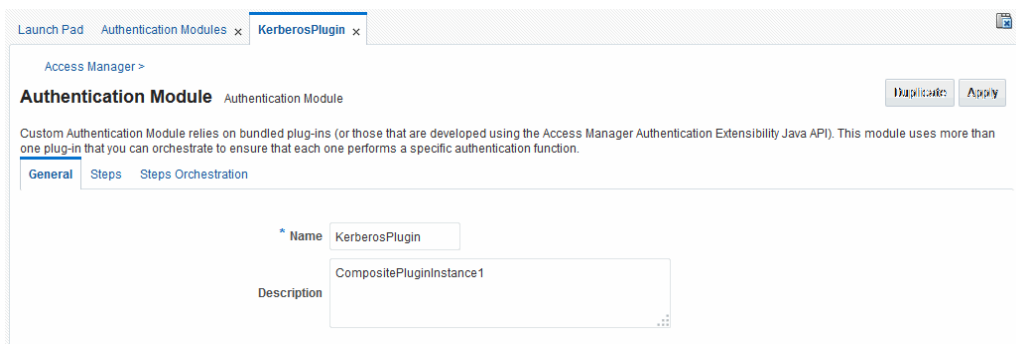

[Figure 22-14](#) shows the default steps and details. [Figure 22-15](#) shows the orchestration of the steps and conditions.

Figure 22-14 Default KerberosPlugin Steps and Details

Authentication Module Authentication Module Duplicate Apply

Custom Authentication Module relies on bundled plug-ins (or those that are developed using the Access Manager Authentication Extensibility Java API). This module uses more than one plug-in that you can orchestrate to ensure that each one performs a specific authentication function.

General **Steps** Steps Orchestration

View + × Detach

Step Name	Description	Plug-in Name
stepUI	CompositePluginInstance1	UserIdentificationPlugin
stepUA	CompositePluginInstance1	UserAuthenticationPlugin
stepKTI	CompositePluginInstance1	KerberosTokenIdentifier
stepKTA	CompositePluginInstance1	KerberosTokenAuthenticator
stepUIF	CompositePluginInstance1	UserIdentificationPlugin

Step Details Save Cancel

Step Name stepUI

Description CompositePluginInstance1

Plug-in Name UserIdentificationPlugin

Plug-in Parameters

KEY_IDENTITY_STORE_REF

KEY_LDAP_FILTER

KEY_SEARCH_BASE_URL

Figure 22-15 Default KerberosPlugin Steps and Orchestration

Authentication Module Authentication Module Duplicate Apply

Custom Authentication Module relies on bundled plug-ins (or those that are developed using the Access Manager Authentication Extensibility Java API). This module uses more than one plug-in that you can orchestrate to ensure that each one performs a specific authentication function.

General **Steps** **Steps Orchestration**

You can specify the initial step

* Initial Step

Name	Description	On Success	On Failure	On Error
stepKTI	KerberosTokenIdentifier	stepKTA	stepUI	failure
stepKTA	KerberosTokenAuthenticator	stepUIF	failure	failure
stepUIF	UserIdentificationPlugin	success	failure	failure
stepUI	UserIdentificationPlugin	stepUA	failure	failure
stepUA	UserAuthenticationPlugin	success	failure	failure

LDAPPlugin

Figure 22-16 shows the LDAPPlugin module that is bundled with Access Manager. By default, LDAPPlugin has 2 steps, shown in Figure 22-17. Figure 22-18 shows the default orchestration of steps for LDAPplugin.

Figure 22-16 LDAPPlugin

Authentication Module Authentication Module Duplicate Apply

Custom Authentication Module relies on bundled plug-ins (or those that are developed using the Access Manager Authentication Extensibility Java API). This module uses more than one plug-in that you can orchestrate to ensure that each one performs a specific authentication function.

General **Steps** Steps Orchestration

* Name LDAPPlugin

Description CompositePluginInstance1

Figure 22-17 Default LDAPPlugin Steps and Details

Authentication Module Authentication Module Duplicate Apply

Custom Authentication Module relies on bundled plug-ins (or those that are developed using the Access Manager Authentication Extensibility Java API). This module uses more than one plug-in that you can orchestrate to ensure that each one performs a specific authentication function.

General **Steps** Steps Orchestration

View

Step Name	Description	Plug-in Name
stepUI	CompositePluginInstance1	UseridentificationPlugin
stepUA	CompositePluginInstance1	UserAuthenticationPlugIn

Step Details

Step Name stepUI

Description CompositePluginInstance1

Plug-in Name UseridentificationPlugin

Plug-in Parameters

KEY_IDENTITY_STORE_REF

KEY_LDAP_FILTER

KEY_SEARCH_BASE_URL

Figure 22-18 Default Orchestration of Steps for LDAPplugin

Authentication Module Authentication Module Duplicate Apply

Custom Authentication Module relies on bundled plug-ins (or those that are developed using the Access Manager Authentication Extensibility Java API). This module uses more than one plug-in that you can orchestrate to ensure that each one performs a specific authentication function.

General **Steps** Steps Orchestration

You can specify the initial step

* Initial Step

Name	Description	On Success	On Failure	On Error
stepUI	UseridentificationPlugin	stepUA	failure	failure
stepUA	UserAuthenticationPlugIn	success	failure	failure

X509Plugin

Figure 22-19 shows the X509Plugin module that is bundled with Access Manager 11g. The X509Plugin is similar to the LDAPPlugin with additional properties that indicate which attribute of the client's X.509 certificate should be validated against the user attribute in LDAP. Figure 22-20 shows default steps and details for this plug-in. Figure 22-21 shows the default orchestration of steps for the X509Plugin.

Figure 22-19 X509Plugin

Authentication Module Authentication Module Duplicate Apply

Custom Authentication Module relies on bundled plug-ins (or those that are developed using the Access Manager Authentication Extensibility Java API). This module uses more than one plug-in that you can orchestrate to ensure that each one performs a specific authentication function.

General **Steps** Steps Orchestration

* Name

Description

Figure 22-20 X509Plugin Default Steps and Details

Authentication Module Authentication Module Duplicate Apply

Custom Authentication Module relies on bundled plug-ins (or those that are developed using the Access Manager Authentication Extensibility Java API). This module uses more than one plug-in that you can orchestrate to ensure that each one performs a specific authentication function.

General **Steps** Steps Orchestration

View + × Detach

Step Name	Description	Plug-in Name
stepX509	CompositePluginInstance1	X509CredentialExtractor
stepUI	CompositePluginInstance1	UserIdentificationPlugin

Step Details Save Cancel

Step Name stepX509

Description CompositePluginInstance1

Plug-in Name X509CredentialExtractor

Plug-in Parameters

KEY_IS_CERT_VALIDATION_ENABLED

KEY_CERTIFICATE_ATTRIBUTE_TO_EXTRACT

With this plug-in, the root and sub CA certificates must be added to the \$DOMAIN_HOME/config/fmwconfig/amtruststore because the X509CredentialExtractor plug-in loads certificates from this location.

Table 22-15 lists the stepX509 values for Subject and Subject Alternative Names. Such processing is only supported when the X509Plugin is used.

See Also:

- [Table 22-13](#)
- [Example: Leveraging SubjectAltName Extension Data and Integrating with Multiple OCSP Endpoints](#)

Table 22-15 X509 Step Details (KEY_CERTIFICATE_ATTRIBUTE_TO_EXTRACT)

issuer.D	Subject
subject.	EDIPI Note: EDIPI refers to the Electronic Data Interchange Personal Identifier.
subjectAltName.	OTHER_NAME (FASC-N) Note: FASC-N refers to the Federal Agency Smart Credential Number.
subjectAltName.	RFC822_NAME
subjectAltName.	UNIFORM_RESOURCE_IDENTIFIER

Figure 22-21 Default Orchestration for X509Plugin Steps

Authentication Module Authentication Module Duplicate Apply

Custom Authentication Module relies on bundled plug-ins (or those that are developed using the Access Manager Authentication Extensibility Java API). This module uses more than one plug-in that you can orchestrate to ensure that each one performs a specific authentication function.

General Steps **Steps Orchestration**

You can specify the initial step

* Initial Step

Name	Description	On Success	On Failure	On Error
stepX509	X509CredentialExtractor	<input type="text" value="stepUI"/>	<input type="text" value="failure"/>	<input type="text" value="failure"/>
stepUI	UserIdentificationPlugin	<input type="text" value="success"/>	<input type="text" value="failure"/>	<input type="text" value="failure"/>

See Also:

["Example: Leveraging SubjectAltName Extension Data and Integrating with Multiple OCSP Endpoints"](#)

Password Policy Validation Module and Plug-ins

Oracle provides a Password Policy Validation Module that employs the following plug-ins as individual steps in the authentication process:

- User Identification Step
- User Authentication Step
- User Password Status Step

Figure 22-22 shows the Steps tab. Additional details follow the figure.

Figure 22-22 Password Policy Validation Module Plug-ins

Authentication Module Authentication Module Duplicate Apply

Custom Authentication Module relies on bundled plug-ins (or those that are developed using the Access Manager Authentication Extensibility Java API). This module uses more than one plug-in that you can orchestrate to ensure that each one performs a specific authentication function.

General **Steps** Steps Orchestration

View

Step Name	Description	Plug-in Name
User Identification Step		UserIdentificationPlugin
User Authentication Step		UserAuthenticationPlugin
User Password Status St...		UserPasswordPolicyPlugin

Step Details Save Cancel

Step Name

Description

Plug-in Name

Plug-in Parameters

KEY_LDAP_FILTER

KEY_IDENTITY_STORE_REF

KEY_SEARCH_BASE_URL

Figure 22-23 shows the Steps Orchestration page for the Password Policy Validation Module plug-ins, which is self explanatory.

See Also:

- [Table 22-13](#)
- [Accessing Password Policy Configuration Page](#)

Figure 22-23 Steps Orchestration: Password Policy Validation Plug-ins

Authentication Module Authentication Module Duplicate Apply

Custom Authentication Module relies on bundled plug-ins (or those that are developed using the Access Manager Authentication Extensibility Java API). This module uses more than one plug-in that you can orchestrate to ensure that each one performs a specific authentication function.

General Steps **Steps Orchestration**

You can specify the initial step

* Initial Step

Name	Description	On Success	On Failure	On Error
User Identification Step		User Authentication Step	failure	failure
User Authentication Step		User Password Status Step	User Password Status Step	failure
User Password Status Step		success	failure	failure

22.7.4 Example: Leveraging SubjectAltName Extension Data and Integrating with Multiple OCSP Endpoints

Access Manager 11g support for personal identity verification (PIV) cards (a United States Federal smart card), is to use FASC-N and EDIPI attributes from the SubjectAltName extension to map the user during X.509 authentication. While multiple OCSP providers are not supported, you can use an OCSP Gateway or write a custom authentication plug-in that uses the OSDT OCSP APIs to validate against multiple OCSP providers.

The following functionality is available only with the X.509 Plug-in (not the X.509 Authentication module). The Plug-in configuration specifies the LDAP attribute to which the extracted attribute from the X.509 client certificate will be mapped.

1. In the Oracle Access Management Console, click **Application Security** at the top of the window.
2. In the **Plug-ins** section, click **Authentication Modules**.
3. In the list of modules, select the **X509Plugin** module.
4. In the page that opens, click **Duplicate** and fill out the fields as follows:

See Also:

["Creating a Custom Authentication Module using Bundled Plug-ins"](#)

General Tab:

- a. Name: *CustomX509Plugin*.
- b. Description: *Custom Plug-in for X509*.

Steps Tab:

- a. Click + to add a step to the plug-in.
- b. Enter a Name and Description, then select the *X509CredentialExtractor* plug-in.

Step Details:

- a. `KEY_IS_CERT_VALIDATION_ENABLED` true.
- b. `KEY_CERTIFICATE_ATTRIBUTE_TO_EXTRACT` (Table 22-15):
`subject.EDIPI, subjectAltName.OTHER_NAME (FASC-N),`
`subjectAltName.RFC822_NAME,`
`subjectAltName.UNIFORM_RESOURCE_IDENTIFIER`
- c. Click the **Save** button.

Add Another Plug-in:

- a. Click + to add a different plug-in.
- b. Enter the Name, Description, and select *UserIdentificationPlugin*

Step Details for Second Plug-in:

- a. Set `KEY_IDENTITY_STORE_REF` to the required identity store.
- b. Add the LDAP filter to the `KEY_LDAP_FILTER` attribute. For example:

```
(&(uid=
Unknown macro: {subject.CN}
)(mail=
Unknown macro: {subject.E}
))
```
- c. Add the user search base, if required, to the `KEY_SEARCH_BASE_URL` attribute.
- d. Click the **Save** button.
- e. Proceed to Step Orchestration tab (Step2).

5. Orchestrate Steps:

- a. **Initial Step:** Select the *X509CredentialPlugin* Step from the drop down.
- b. **On Success:** *X509CredentialPlugin* step, select the *UserIdentificationPlugin* Step from the drop down list.
- c. **On Success:** *UserIdentificationPlugin* step, select *Success* from the drop down list.
- d. **On Failure:** Select *Failure* for both *X509CredentialPlugin* and *UserIdentificationPlugin* steps.
- e. **On Error:** Select *Failure* for both *X509CredentialPlugin* and *UserIdentificationPlugin* steps.
- f. Click the **Apply** button and review the confirmation window stating that the plug-in has been created successfully.

6. Set up the Certificate Validation Module for Certificate Validation and Revocation using OCSP.

See Also:

["Certificate Validation and Revocation"](#)

- a. In the Oracle Access Management Console, click **Configuration** at the top of the window.
 - b. In the Configuration console, click **Certificate Validation**.
 - c. In the Certificate Revocation list, confirm that **Enabled** is checked, then click **Save**.
 - d. In the OCSP/CDP section, enable OCSP, enter the OCSP URL and the Subject of the OCSP Server's certificate, then click **Save**.
 - e. On the command line, use the Java keytool application to import the trusted certificates into the `$DOMAIN_HOME/config/fmwconfig/amtruststore` keystore, as trusted certificate entries.
-

Note:

Initially the keystore is empty; its password is set the first time the Java keytool application is used.

22.7.5 Creating a Custom Authentication Module using Bundled Plug-ins

Users with valid Administrator credentials can create custom authentication module that uses one or more authentication plug-ins.

This procedure outlines general steps for any authentication module (with sample information to configure an authentication X509 module for use with the Online Certificate Status Protocol (OCSP) to maintain the security of a server and other network resources).

See Also:

- ["Example: Leveraging SubjectAltName Extension Data and Integrating with Multiple OCSP Endpoints"](#)
 - ["Steps and Plug-ins in Customized Step-up Authentication Module"](#)
-

Prerequisite

Ensure that any user identity store associated with the module is running and includes the required user population.

1. In the Oracle Access Management Console, click **Application Security** at the top of the window.
2. In the Application Security console, select **Create Custom Authentication Module** from the **Create (+)** drop-down list in the **Plug-ins** section.
3. In the page that appears, enter the Name and optional Description. For example: *CustomX509Plugin* and *Plugin for X509*, respectively.

Click **Apply** to save general information.

4. **Add Steps:**
 - a. Click the **Steps** subtab.
 - b. Click the **Add (+)** button above the Steps table.
 - c. In the Add New Step dialog box, enter a unique Step Name and optional Description.
 - d. Browse for and select the desired plug-in name (*X509CredentialExtractor*, for instance) and click **OK**.
 - e. Confirm information in the results table.
 - f. Repeat b through e to add other steps until you have listed all required plug-ins for your module.
5. **Define Step Details:** Use appropriate values for requested parameters ([Table 22-12](#), [Table 22-13](#), [Table 22-17](#) and "[Example: Leveraging SubjectAltName Extension Data and Integrating with Multiple OCSP Endpoints](#)"):
 - a. Click a *StepName* in the table to reveal required details, enter appropriate values for the requested details.
 - b. **Validate User Cert using OCSP:**

Confirm that `KEY_IS_CERT_VALIDATION_ENABLED` is set to `true`.

Add the certificate attributes to be extracted with `KEY_CERTIFICATE_ATTRIBUTE_TO_EXTRACT` ([Table 22-15](#)):

```
subject.EDIPI
subjectAltName.OTHER_NAME (FASC-N)
subjectAltName.RFC822_NAME
subjectAltName.UNIFORM_RESOURCE_IDENTIFIER
```
 - c. Click the Save button.
 - d. Repeat to configure each step appropriately.
 - e. Ensure that users are provisioned in any user identity stores assigned in the steps.
6. **Orchestrate Steps:** See [Table 22-14](#) as you perform following steps.
 - a. Click the Steps Orchestration subtab.
 - b. From the InitialStep list, choose the name of the first step to be used.
 - c. Select a *StepName* in the table.
 - d. From the OnSuccess List, choose a condition (success or failure) or a step name.
 - e. From the OnFailure List, choose the desired condition or a *StepName*.
 - f. From the OnError List, choose the desired condition or a *StepName*.
 - g. Repeat Steps c through f to orchestrate operations for each plug-in in this module.

- h. Review your orchestration.
7. **Initiate Strategy Validation:** Click **Apply** to initiate validation of your orchestration strategy:
 - **Successful Strategy:** The orchestration strategy is applied and the module is ready to include in an authentication scheme. Continue with Steps 9 and 10.
 - **Invalid Strategy:** Click **OK** in the Error box, then edit your OnSuccess, OnFailure, OnError strategies (or add or remove plug-ins) to correct the problem. Repeat this step until your strategy is successful.
8. In the navigation tree, confirm the new Custom Authentication Module is listed, and then close the page when you finish.
9. Use your custom module in an authentication scheme, as described in "[Managing Authentication Schemes](#)".

22.7.6 Steps and Plug-ins in Customized Step-up Authentication Module

The processing that occurs with a customized step-up authentication module is driven by the steps and plug-ins described in [Table 22-16](#). For more information, see [Table 22-13](#).

Table 22-16 Steps and Plug-ins in a Customized Step-up Authentication Module

Step #	Step Name	Plug-in Name	Description
1	StandardLevelCheck-2	UserAuthnLevelCheck Plugin	<p>Configurable with the LevelCheck Rule and credentials parameters associated with the SUCCESS or FAILURE outcome resulting from the check.</p> <p>This plugin communicates with the authentication engine to determine the current authentication level of the user and compares it with the plugin level parameter AUTHN_LEVEL_FOR_PLUGIN. It interacts with a custom credential collector and checks the current Authentication Level of the user against the value specified. For example, if 2 is specified for X:</p> <ul style="list-style-type: none"> • Authentication Level \geq X returns ExecutionStatus.SUCCESS and proceeds to the next step; for example it will check for higher level authentication. • Authentication Level $<$ X returns ExecutionStatus.FAILURE and proceeds to the next step in the plugin; for example it will collect the standard credentials for level 2 (username and password). <p>Specifies parameters to collect depending on whether the Authentication Level check succeeded or failed:</p> <ul style="list-style-type: none"> • ON SUCCESS, go to SensitiveLevelCheck-6 • ON FAILURE, go to CollectUserNamePassword • ON ERROR, Failure

Table 22-16 (Cont.) Steps and Plug-ins in a Customized Step-up Authentication Module

Step #	Step Name	Plug-in Name	Description
2	CollectUserNamePassword	CredentialCollectorPlugIn Flow must start with the Plug-in communicating the credential parameters to collect. The Action must support allowing the Server to mark parameters as immutable.	<p>This plugin interacts with the credential collector (CustomReadServlet) to allow the administrator to configure the credentials collected for authentication. Credentials to be collected are configured as step parameters. The plugin validates these parameters and renders the UI to collect them.</p> <p>The user provides the credentials that need to be collected in the step parameter. In this example, since in previous step user was not authenticated to level 2, he will be prompted to enter a user name and password.</p> <ul style="list-style-type: none"> loginPageURL: /CustomRead/Servlet (generic credential collector for UserAuthnLevelCheckPlugin to render the interface to acquire plug-in specified credentials. No_OF_CREDENTIALS: 4 CRED_PARAM_4 CRED_PARAM_3 CRED_PARAM_2: {ID=KEY_PASSWORD}, {DISPLAY_NAME=KEY_PASSWORD}, {TYPE=password} CRED_PARAM_1: {ID=KEY_USERNAME}, {DISPLAY_NAME=KEY_USERNAME }, {TYPE=text} actiontype: FORWARD <p>Credentials to be collected should be specified in this format only for the credential collector to render the UI interface.</p> <p>Also specifies action on:</p> <ul style="list-style-type: none"> ON SUCCESS, go to UserIdentificationProcess ON FAILURE, Failure ON ERROR, Failure
3	UserIdentificationProcess	UserIdentificationPlugIn	<p>Out of the box plug-in that maps the user to a specific LDAP user record:</p> <ul style="list-style-type: none"> ON SUCCESS, go to UserAuthenticationStep ON FAILURE, Failure ON ERROR, Failure
4	UserAuthenticationStep	UserAuthenticationPlugIn	<p>Out of the box plug-in that authenticates the supplied username and password credentials against an LDAP directory.</p> <ul style="list-style-type: none"> ON SUCCESS, go to SensitiveLevelCheck-6 ON FAILURE go to CollectSensitiveLevelCreds ON ERROR, Failure

Table 22-16 (Cont.) Steps and Plug-ins in a Customized Step-up Authentication Module

Step #	Step Name	Plug-in Name	Description
5	SensitiveLevelCheck-6	UserAuthnLevelCheck Plugin	This plugin communicates with the authentication engine to determine the current authentication level of the user and compares it with the plugin level parameter AUTHN_LEVEL_FOR_PLUGIN. It interacts with a custom credential collector and checks the current Authentication Level of the user against the value specified. Specifies parameters to collect depending on whether the check succeeded or failed: <ul style="list-style-type: none"> • ON SUCCESS, Success • ON FAILURE, go to CollectSensitiveLevelCreds • ON ERROR, Failure
6	CollectSensitiveLevelCreds	CredentialCollectorPlugin	This plugin renders the UI for collecting credentials for level 6 authentication. This is similar to CollectUserNamePwd. <ul style="list-style-type: none"> • ON SUCCESS, go to ValidateSensitiveLevelCreds • ON FAILURE, Failure • ON ERROR, Failure • CRED_PARAM_1: {ID=securitycode}, {DISPLAY_NAME=form_securecode}, {TYPE=text}
7	ValidateSensitiveLevelCreds	SubjectSetPlugin	This custom developed plug-in validates the security code against the server. <ul style="list-style-type: none"> • ON SUCCESS, Success • ON FAILURE, Failure • ON ERROR, Failure

After defining and orchestrating plug-ins in an authentication module, you can use the module in an authentication scheme and use the scheme in a policy.

See Also:

["Creating a Custom Authentication Module using Bundled Plug-ins"](#)

22.7.7 Configuring Step-up Authentication

You can define step-up authentication using plug-ins within a customized module.

In this example, there are users who need standard level access to pages on the corporate portal and those who need access to sensitive information. For standard applications, authentication credentials include username and password. For sensitive applications, credentials include username, password, and a security code (the later obtained with a custom plugin that validates the code).

1. Create or edit a custom authentication module for step up authentication:

Authentication Module Authentication Module Apply

Custom Authentication Module relies on bundled plug-ins (or those that are developed using the Access Manager Authentication Extensibility Java API). This module uses more than one plug-in that you can orchestrate to ensure that each one performs a specific authentication function.

General Steps Steps Orchestration

* Name Step-Up Authentication

Description

2. Define your custom authentication module based on the Steps shown here.

Authentication Module Authentication Module Apply

Custom Authentication Module relies on bundled plug-ins (or those that are developed using the Access Manager Authentication Extensibility Java API). This module uses more than one plug-in that you can orchestrate to ensure that each one performs a specific authentication function.

General Steps Steps Orchestration

View + X Detach

Step Name	Description	Plug-in Name
StandardLevelCheck-2		UserAuthnLevelCheckPlugin
CollectUserNamePassword		CredentialCollectorPlugin
UserIdentificationProcess		UserIdentificationPlugin
UserAuthenticationStep		UserAuthenticationPlugin
SensitiveLevelCheck-6		UserAuthnLevelCheckPlugin
CollectSensitiveLevelCreds		CredentialCollectorPlugin
ValidateSensitiveCreds		UserAuthenticationPlugin

Step Details Save Cancel

Step Name CollectUserNamePassword

Description

Plug-in Name CredentialCollectorPlugin

Plug-in Parameters

loginPageURL /CustomReadServlet

NO_OF_CREDENTIALS 4

CRED_PARAM_4 (ID=KEY_PIN),(DISPLAY_NAME=KEY_PIN),(TYPE=passwo

CRED_PARAM_3 (ID=securitycode),(DISPLAY_NAME=form_securecode),(TY

CRED_PARAM_1 (ID=KEY_USERNAME),(DISPLAY_NAME=KEY_USERNAME

actiontype FORWARD

CRED_PARAM_2 (ID=KEY_PASSWORD),(DISPLAY NAME=KEY_PASSWOR

3. Orchestrate your Steps and Plug-ins as shown here and described in [Table 22-16](#).

Authentication Module Authentication Module

Custom Authentication Module relies on bundled plug-ins (or those that are developed using the Access one plug-in that you can orchestrate to ensure that each one performs a specific authentication function.

✔ Confirmation

Authentication Module created successfully.

General Steps **Steps Orchestration**

You can specify the initial step

* Initial Step

Name	Description	On Success
StandardLevelCheck-2		SensitiveLevelCheck-6
CollectUserNamePassword		UserIdentificationProcess
UserIdentificationProcess		UserAuthenticationStep
UserAuthenticationStep		SensitiveLevelCheck-6
SensitiveLevelCheck-6		success
CollectSensitiveLevelCreds		ValidateSensitiveCreds
ValidateSensitiveCreds		success

- Sensitive Scheme:** Create or edit an Authentication Scheme for sensitive applications that uses your customized step-up authentication module. For example:

See Also:

["Managing Authentication Schemes"](#)

Create Authentication Scheme Authentication Scheme Set As Default Apply

An Authentication Scheme defines the challenge mechanism required to authenticate a user. Each Authentication Scheme must also include a defined Authentication Module.

1 **Name** Sensitive-Auth-Scheme-1

2 **Description**

3 **Authentication Level** 6

4 **Default**

5 **Challenge Method** FORM

6 **Challenge Redirect URL** /oam/server

7 **Authentication Module** Step-Up-Authn-Module

8 **Challenge URL** /CustomReadServlet

9 **Context Type** customHtml

10 **Context Value** /sensapp/custom.html

11 **Challenge Parameters** initial_command=NONE

5. **Lower-Level Scheme:** Create or edit an Authentication Scheme for the lowest level applications using your customized step-up authentication module. For example:

Create Authentication Scheme Authentication Scheme Set As Default Apply

An Authentication Scheme defines the challenge mechanism required to authenticate a user. Each Authentication Scheme must also include a defined Authentication Module.

1 **Name** Lower-Auth-Scheme-1

2 **Description**

3 **Authentication Level** 2

4 **Default**

5 **Challenge Method** FORM

6 **Challenge Redirect URL** /oam/server

7 **Authentication Module** Step-Up-Authn-Module

8 **Challenge URL** /CustomReadServlet

9 **Context Type** customHtml

10 **Context Value** /sensapp/custom.html

11 **Challenge Parameters** initial_command=NONE

6. **Sensitive Policy:** Create or edit an Authentication Policy for sensitive-level resources using your customized step-up Authentication Scheme. For example:

See Also:

[Managing Policies to Protect Resources and Enable SSO](#)

Create Authentication Policy Authentication Policy Apply

Authentication Policy defines the type of verification that must be performed to provide a sufficient level of trust for Access Manager to grant access to the user making the request. A single policy can be defined to protect one or more resources in the Application Domain.

* Name: Success URL:

Description:

* Authentication Scheme: Failure URL:

Resources Responses Advanced Rules

Resources + Add ✖ Delete

Resource Type	Host Identifier	Resource URL	Query String
This Policy does not protect any Resources			

7. **Lower-Level Policy:** Create or edit an Authentication Policy for the lowest level resources using your customized step-up Authentication Scheme. For example:

Create Authentication Policy Authentication Policy Apply

Authentication Policy defines the type of verification that must be performed to provide a sufficient level of trust for Access Manager to grant access to the user making the request. A single policy can be defined to protect one or more resources in the Application Domain.

* Name: Success URL:

Description:

* Authentication Scheme: Failure URL:

Resources Responses Advanced Rules

Resources + Add ✖ Delete

Resource Type	Host Identifier	Resource URL	Query String
This Policy does not protect any Resources			

8. **Verify:** Verify your resources and the policies that protect them.

22.7.8 Configuring an HTTPToken Extractor Plug-in

You can configure an HTTPToken Extractor plug-in.

To configure:

1. Create a sample plug-in that will re-direct the user to the authenticating application.

The authenticating application will authenticate the user and set the user name in the HTTP header or cookie.

2. Create a custom authentication module that will access any applicable plug-ins.

For example, if you add the plug-in created in the previous step and the HTTPToken Extractor and User identification plug-ins, successful authentication occurs when the process for all three plug-ins has been successfully completed.

3. Add values for the header name and the user search filter properties.

The `KEY_HEADER_PROPERTY` is set in the HTTPToken Extractor plug-in while `KEY_LDAP_FILTER` is set in the UI plug-in. For example:

- `KEY_HEADER_PROPERTY = cookieorheadername`
- `KEY_LDAP_FILTER = (uid={cookieorheadername})`

Note:

The user should be present in the data store which is being used.

22.7.9 JSON Web Token Plug-in

Oracle Access Manager (OAM) provides complete but different access management solutions for both users and applications. After OAM authentication, SSO tokens are issued which can be used with WebGates or products like Oracle API Gateway. These tokens are specific to OAM though and there are often business requirements where Web services or REST services need to be protected. While OAM tokens can be used to protect web services, they are usually protected by standard tokens. A JSON Web Token (JWT) is one of the standard tokens that is widely used.

In the RSPS2 release, OAM introduced complete support for an OAuth authorization service provided by the Oracle Access Manager Mobile and Social (OAMMS) service. The OAuth Service issues a JSON Web Token (JWT) for accessing Web services subsequent to the user's authentication and/or authorization. Thus, a user can be authenticated with an OAM authentication mechanism and subsequently have both an OAM and a JWT for access to different resources. A typical scenario in which this can be used is when a WebGate protected application is accessed. The user is authenticated by an OAM authentication module and both an OAM token and a JWT are provided. The OAM token is used for access through the WebGate and the JWT can be used to access a Web service or a REST service when needed. (The Web service or REST service is protected by a product like Oracle API Gateway or Oracle Web Services Manager.)

A JSON Web Token Plug-in is now available in OAM. Use this JSON Web Token Plug-in when you need to protect REST or Web services with standard tokens. The JSON Web Token Plug-in issues both an OAM token and a Mobile and Social JWT that can be used for Web services access. Oracle API Gateway and Oracle Web Services Manager can use this JWT for Web services protection as well. See the following sections for additional details.

- [Understanding the JSON Web Token Plug-in](#)
- [Configuring the JSON Web Token Plug-In](#)

22.7.9.1 Understanding the JSON Web Token Plug-in

You can use JSON Web Token Plug-in in deployments.

The following flow describes how to use JSON Web Token Plug-in:

- Configure the Oracle Access Management WebGate to use both OAM authentication and the JSON Web Token Plug-in.
- When a user accesses a resource protected by the WebGate, the WebGate redirects the user to authenticate with Access Manager.
- Upon authentication, the plug-in identifies which OAuth service end point should generate the JWT. (OAuth service end points are unique and can be configured to point to a specific OAuth service profile within a specific Identity Domain.) Oracle Access Manager Mobile and Social creates the JWT and the plug-in returns it as a cookie. (The cookie name can be configured in the plug-in configuration.)
- The Web application intercepts the response and accesses the cookie so that it can be used later for Web service access. Depending on how the web application is

deployed, there may be other options to retrieve the JWT. The user can now access the Web resource.

- When the Web resource needs to access a Web service, it extracts the OAM Mobile and Social JWT and sends it to the Oracle API Gateway.
- The Oracle API Gateway uses the Oracle OAuth Service REST API to validate the token. It then grants access to the Web service. The Oracle API Gateway can also validate the JWT locally without making a remote call to the OAuth service.

Note:

Currently there is not a mechanism to pass scope to the OAuth service while issuing a JWT with OAM authentication. Consequently, the token should be considered to have global scope.

Both the OAM token timeout and the JWT timeout can be set to the same value to have the same validity. The OAM tokens and JWT are not linked, so they cannot be terminated using single logout.

22.7.9.2 Configuring the JSON Web Token Plug-In

You can configure the JSON Web Token Plug-in.

You will be creating a custom authentication module.

1. In the Oracle Access Management Console, click Application Security at the top of the window.
The Search Authentication Modules screen is displayed.
2. Select **Create Custom Authentication Module** from the **Create (+)** drop-down menu in the Plug-ins section.
The General tab is displayed.
3. Enter a name (and optional description) for the custom authentication module.
For this example, we name the module JWTToken AuthnModule.
4. Click the **Steps** tab and the + (plus sign) to add a new step.
The Add New Step dialog is displayed. Three new steps will be added.
5. Specify a step name (and optional description), select an activated plug-in from the Plug-in name drop down list and click OK.
For this example, the values are StepUI and UserIdentificationPlugin. The flow parameters for that plug-in can be edited after it is added to the step
6. Enter values for the UserIdentificationPlugin parameters and click Save.
7. Click the + (plus sign) to add a second step, enter the name StepUA, select **UserAuthenticationPlugin** from the drop down list and click OK.
8. Enter values for the UserAuthenticationPlugin parameters and click Save.
9. Click the + (plus sign) to add a third step, enter the name StepOAuth, select **OAuthTokenResponsePlugin** from the drop down list and click OK.
10. Enter values for the OAuthTokenResponsePlugin parameters and click Save.

11. Click the **Steps Orchestration** tab to configure the orchestration of the steps in the following order.
 - a. StepUI
 - b. StepUA
 - c. StepOAuth
12. Click **Apply** and close the Custom Authentication Module tab.
13. Click **Authentication Schemes** from the Launch Pad.
14. Select **LDAPScheme** and click **Duplicate**.

A Copy of LDAPScheme screen displays.
15. Change the value of Name to JWTToken AuthnScheme and the value of Authentication Module to JWTToken AuthnModule.
16. Click **Save**.
17. Configure an Authentication policy with the newly defined JWTToken AuthnScheme Authentication Scheme.

22.8 Deploying and Managing Individual Plug-ins for Authentication

This section provides the following topics:

- [About Managing Your Own Authentication Plug-ins](#)
- [Making Custom Authentication Plug-ins Available for Use](#)
- [Checking an Authentication Plug-in's Activation Status](#)
- [Deleting Your Custom Authentication Plug-ins](#)

22.8.1 About Managing Your Own Authentication Plug-ins

You can create custom authentication plug-ins and use them to define customized multi-step authentication modules.

Using information in the *Oracle Fusion Middleware Developer's Guide for Oracle Access Management*, the plug-ins can be created. After development, the plug-in must be deployed on the AdminServer, as a JAR file, which is validated automatically. After validation, an Administrator can configure and distribute the plug-in using the Oracle Access Management Console.

The server processes the XML configuration file within the plug-in JAR file to extract data about the plug-in. After the plug-in is imported, an Administrator can see and modify the various plug-in states based on information available from the AdminServer.

[Figure 22-24](#) illustrates the Plug-ins Node under the Common Configuration section of the System Configuration tab, and the Plugins page. This Plugins page includes a tool bar with command buttons, most of which operate on the plug-in that is selected in the table. The table provides information about the existing custom plug-ins and their state. The Plugin Details section at the bottom of the page reflects configuration details for the selected plug-in in the table.

Figure 22-24 Plug-ins Page
Plug-ins

Use the following screen to set up custom Plug-ins to extend Authentication functionality for Oracle Access Manager with Oracle Security Token Service.

Row	Plug-in Name	Description	Activation Status	Type	Last updated On	Last updated by
12	SIMFedModelIdentifierPlugin		Activated	Authentication		
13	BasicFedModelIdentifierPlugin		Activated	Authentication		
14	SIMBasicFedModelIdentifierPlugin		Activated	Authentication		
15	FedProgramaticAuthnPlugin		Activated	Authentication		
16	X509CredentialExtractor		Activated	Authentication		

Total Rows: 36

Administrators control plug-in states using the command buttons across the table at the top of the Plug-ins page, as described in [Table 22-17](#).

Table 22-17 Managing Custom Plug-ins Actions

Action Button	Description
Import Plugin...	<p>Adds the plug-in JAR file to the AdminServer $\\$DOMAIN_HOME/oam/plugins$ and begins plug-in validation.</p> <ul style="list-style-type: none"> • Same JAR Name: If the new plug-in JAR name (in $\\$DOMAIN_HOME/oam/plugins$) matches an existing plug-in JAR name (in $\\$DOMAIN_HOME/config/fmwconfig/oam/plugins$), Oracle Access Manager extracts new configuration metadata from the XML file in the JAR (in $\\$DOMAIN_HOME/oam/plugins$) and checks the version of the new plug-in. • XML Version: If the new plug-in XML version (in $\\$DOMAIN_HOME/oam/plugins$) is greater than the existing XML version (in $\\$DOMAIN_HOME/config/fmwconfig/oam/plugins$), validation is successful. Otherwise, "invalid plugin name with invalid version" is returned and the new plug-in JAR is removed (from $\\$DOMAIN_HOME/oam/plugins$). • Different JAR Name: If the new plug-in JAR name (in $\\$DOMAIN_HOME/oam/plugins$) is different then existing plug-in JAR names (in $\\$DOMAIN_HOME/config/fmwconfig/oam/plugins$), the new plug-in JAR is uploaded and validation is successful. <p>On Success: Status is reported as "Uploaded" (even if an OAM Server is down). If all registered OAM Servers report "Uploaded", then the status on AdminServer is also "Uploaded".</p> <p>On Failure: Status is reported as "Upload Failed"</p> <p>See Also: "About the Custom Plug-in Life Cycle" in the <i>Oracle Fusion Middleware Developer's Guide for Oracle Access Management</i></p>
Distribute Selected	<ul style="list-style-type: none"> • Propagates the plug-in to all registered OAM Servers. • Sets the plug-in flag in oam-config.xml to "Distribute=true". • Starts the distribution listener and notification mechanism between AdminServer and OAM Servers • Distributes the plug-in JAR from AdminServer node to each OAM Server node under $\\$DOMAIN_HOME/config/fmwconfig/oam/plugins$ <p>On Success: Status is reported as "Distributed" (even if an OAM Server is down). If all registered OAM Servers report "Distributed", then the status on AdminServer is also "Distributed".</p> <p>On Failure: Status is reported as "Distribution Failed"</p>

Table 22-17 (Cont.) Managing Custom Plug-ins Actions

Action Button	Description
Activate Selected	<p>After successful distribution the plug-in can be activated on all registered OAM Servers.</p> <p>Activation:</p> <ul style="list-style-type: none"> • Updates the plug-in flag in oam-config.xml to "Activate=true" • Starts the Message listener and notification mechanism between AdminServer and OAM Servers • AdminServer sends message "Activate" to all registered OAM Servers <p>On Success: Status is reported as "Activated" (even if an OAM Server is down). If all registered OAM Servers report "Activated", then the status on AdminServer is also "Activated".</p> <p>On Failure: Status is reported as "Activation Failed"</p> <p>Following activation on all OAM Servers, the plug-in can be used and executed in any authentication module construction or orchestration.</p>
Deactivate Selected	<p>Following plug-in activation, an Administrator can choose to deactivate the plug-in: if the plug-in is not used in any authentication module or scheme, for example. The selected plug-in from all registered OAM Servers.</p> <p>Deactivate:</p> <ul style="list-style-type: none"> • Updates the plug-in flag in oam-config.xml to "De-activate=true" • Starts the Distribution listener and notification mechanism between AdminServer and OAM Servers • Removes the plug-in JAR from AdminServer and each registered OAM Server (\$DOMAIN_HOME/config/fmwconfig/oam/plugins) • AdminServer sends message "De-activation" to all registered OAM Servers • OAM Servers send status message to AdminServer using the "Message" listeners on both AdminServer and OAM Server <p>On Success: Status is reported as "De-activation" (even if an OAM Server is down). If all registered OAM Servers report "De-activation", then the status on AdminServer is also "De-activation". Plug-in configuration is removed from oam-config.xml.</p> <p>Note: After deactivation, the plug-in cannot be used or executed in any authentication module or orchestration.</p> <p>On Failure: Status is reported as "De-activation Failed"</p>
Remove Selected	<p>Following plug-in deactivation, an Administrator can delete the selected plug-in. During this process, Access Manager:</p> <p>Delete:</p> <ul style="list-style-type: none"> • Updates the plug-in flag in oam-config.xml to "Remove=true" • Starts the Distribution listener and notification mechanism between AdminServer and OAM Servers • Removes the plug-in JAR from AdminServer and each registered OAM Server (\$DOMAIN_HOME/config/fmwconfig/oam/plugins) • AdminServer sends message "Activate" to all registered OAM Servers <p>On Success: Status is reported as "Removed" (even if an OAM Server is down). If all registered OAM Servers report "Removed", then the status on AdminServer is also "Removed". Plug-in configuration is removed from oam-config.xml.</p> <p>On Failure: Status is reported as "Removal Failed"</p>

Table 22-18 describes elements in the Plugins status table.

Table 22-18 Plugins Status Table

Element	Description
Plugin Name	Extracted from the Plugin name element of the XML metadata file.
Description	Extracted from the description element of the XML metadata file.
Activation Status	Reported activation status based on information from AdminServer.
Type	Extracted from the type element of the XML metadata file.
Last Updated on	Extracted from the creation date element of the XML metadata file.
Last Updated by	Extracted from the author element of the XML metadata file.

In the Plugin Details section of the page, the Activation Status is maintained by the AdminServer, as shown in [Table 22-18](#).

Figure 22-25 Plugin Details: Activation Status of Selected Plug-in**Plug-in Details: UserIdentificationPlugin**

Configuration Parameters	Activation Status
Server Instance Name:	Plug-in Activation Status:
oam_server1	Activated

Depending on your plug-in, various configuration details are extracted from the configuration element of the XML metadata file to populate Configuration Parameters in the Plugin Details section. Examples are shown in [Table 22-19](#); see also, [Table 22-13](#).

Table 22-19 Example of Plugin Details Extracted from XML Metadata File

Configuration Element	Description
DataSource	<pre> - <configuration> - <AttributeValuePair> <Attribute type="string" length="20">DataSource</Attribute> <mandatory>true</mandatory> <instanceOverride>false</instanceOverride> <globalUIOverride>true</globalUIOverride> <value>jdbc/CISCO</value> <AttributeValuePair> </configuration> </pre>
Kerberos Details	<p>Defines the following Kerberos details:</p> <p>KEY_KEYTAB_FILE, KEY_PRINCIPAL, KEY_KRB_CONFIG_FILE</p>
User Identification Details	<p>Defines the User Identity Store and LDAP filter parameters. for this plug-in to use:</p> <p>KEY_IDENTITY_STORE_REF, KEY_LDAP_FILTER</p>
User Authentication Details	<p>Defines the User Identity Store for this plug-in to use:</p> <p>KEY_IDENTITY_STORE_REF</p>

Table 22-19 (Cont.) Example of Plugin Details Extracted from XML Metadata File

Configuration Element	Description
X.509 Details	Defines the X.509 certificate details for this plug-in to use: KEY_CERTIFICATE_ATTRIBUTE_TO_EXTRACT, KEY_IS_CERT_VALIDATION_ENABLED

22.8.2 Making Custom Authentication Plug-ins Available for Use

Users with valid Administrator credentials can add, validate, distribute, and activate a custom plug-in.

Prerequisites

Developing a custom plug-in as described in the *Oracle Fusion Middleware Developer's Guide for Oracle Access Management*

1. Import the Plug-in:

- a. In the Oracle Access Management Console, click **Application Security** at the top of the window
- b. In the Application Security Console, click **Authentication Plug-ins** in the **Plug-ins** section.
- c. In the page that appears, click **Import Plug-in**.
- d. In the Import Plugin dialog box, click **Browse** and select the name of your plug-in JAR file.
- e. Review the message in the dialog box, then click **Import**.

The JAR file is validated as described in *Oracle Fusion Middleware Administrator's Guide for Oracle Access Management*.

2. Configure Parameters: Expand the **Plugin Details** section, click **Configuration Parameters**, and enter appropriate information as needed.

3. Distribute the Plug-in to OAM Servers:

- a. In the Plug-ins table, select the target plug-in.
- b. Click **Distribute Selected**, then check the plug-in's **Activation Status** tab.

4. Activate the Plug-in (and the custom plugin implementation class) so it is ready to be used by OAM Server:

- a. In the Plug-ins table, select the target plug-in.
- b. Click **Activate Selected**, then check the plug-in's Activation Status.

5. Perform the following tasks as needed:

- [Checking an Authentication Plug-in's Activation Status](#)
- [Deleting Your Custom Authentication Plug-ins](#)
- [Creating a Custom Authentication Module using Bundled Plug-ins](#)

22.8.3 Checking an Authentication Plug-in's Activation Status

Users with valid Administrator credentials can activate a custom plug-in and check the status of activation.

Prerequisites

[Making Custom Authentication Plug-ins Available for Use](#)

1. In the Oracle Access Management Console, click **Application Security** at the top of the window
2. In the Application Security console, click **Authentication Plug-ins** in the **Plug-ins** section.
3. In the Plug-ins table, select the target plug-in.
4. **Server Instance Name:** Expand the Plug-in Details section and click **Activation Status** to display the location and status of the plug-in.
5. Perform the following tasks as needed:
 - [Deleting Your Custom Authentication Plug-ins](#)
 - [Creating a Custom Authentication Module using Bundled Plug-ins](#)

22.8.4 Deleting Your Custom Authentication Plug-ins

Users with valid Administrator credentials can deactivate and then delete a custom plug-in.

When an Administrator deletes a custom authentication plug-in, its name is not removed from the list of plug-ins. To delete the plug-in (for the purpose of re-importing the same plug-in later), the Administration must stop the WebLogic Server and edit the oam-config.xml manually.

Prerequisites

The plug-in must have been added and available in the console

1. In the Oracle Access Management Console, click **Application Security** at the top of the window
2. In the Application Security console, click **Authentication Plug-ins** in the **Plug-ins** section.
3. **Deactivate the Plug-in:** You must perform this before removing a plug-in.
 - a. In the Plug-ins table, select the target plug-in.
 - b. Click **Deactivate Selected**, then check the plug-in's Activation Status.
4. **Delete the Deactivated Plug-in:**
 - a. In the Plug-ins table, select the target plug-in.
 - b. Click **Delete Selected**.
 - c. Stop the WebLogic Administration Server, locate and edit oam-config.xml manually to remove the deactivated plug-in, and then restart the WebLogic Administration Server.

5. Perform the following tasks as needed:
 - [Making Custom Authentication Plug-ins Available for Use](#)
 - [Creating a Custom Authentication Module using Bundled Plug-ins](#)

22.9 Managing Authentication Schemes

Access to a resource or group of resources can be governed by a single authentication process known as an authentication scheme. An authentication scheme is a named component that defines the challenge mechanism required to authenticate a user.

Each authentication scheme must also include a defined authentication module (standard or custom, as described in "[Deploying and Managing Individual Plug-ins for Authentication](#)").

When you register a partner (either using the Administration Console or the remote registration tool), the Application Domain that is created is seeded with a policy that uses the authentication scheme that is set as the default scheme. You can choose any of the existing authentication schemes as the default for use during policy creation.

You can also create a new authentication scheme, copy an existing definition to use as a template, modify a definition, or delete the definition. The copy uses a default name that is based on the original. For example, if you copy the scheme named *KerberosScheme*, the copy is named *Copy of KerberosScheme*.

This section is divided into the following topics:

- [Authentication Schemes and Pages](#)
- [Understanding Multi-Level and Step-Up Authentication](#)
- [Creating an Authentication Scheme](#)
- [Viewing, Editing, or Deleting an Authentication Scheme](#)
- [Searching for an Authentication Scheme](#)

22.9.1 Authentication Schemes and Pages

All authentication schemes include the same elements with differing values.

[Figure 22-26](#) shows the default LDAPScheme page as an example.

Figure 22-26 Default LDAPScheme Page

LDAPScheme Authentication Scheme Set As Default

An Authentication Scheme defines the challenge mechanism required to authenticate a user. Each Authentication Scheme must also include a defined Authentication Module.

Name
 Description
 Authentication Level
 Default
 Challenge Method
 Challenge Redirect URL
 Authentication Module
 Challenge URL
 Context Type
 Context Value
 Challenge Parameters

Table 22-20 provides information about each of the elements and values in any authentication scheme. Use the **Set as Default** button to make this the default scheme.

Table 22-20 Authentication Scheme Definition

Element	Description
Name	The unique name for this scheme, which appears in the navigation tree. See Also: " Pre-configured Authentication Schemes "
Description	The optional description, up to 200 characters, that explains the use of this scheme.
Authentication Level	<p>The trust level of the authentication scheme. This reflects the challenge method and degree of trust used to protect transport of credentials from the user.</p> <p>The trust level is expressed as an integer value between 0 (no trust) and 99 (highest level of trust).</p> <p>Note: Level 0 is unprotected. Only unprotected resources can be added to an Authentication Policy that uses an authentication scheme at protection level 0. For more information, see Table 25-1.</p> <p>Note: After a user is authenticated for a resource at a specified level, the user is automatically authenticated for other resources in the same Application Domain or in different Application Domains, if the resources have the same or a lower trust level as the original resource. See Also: "About Multi-Level and Step-Up Authentication".</p>
Default	A non-editable box that is checked when the Set as Default button is clicked.

Table 22-20 (Cont.) Authentication Scheme Definition

Element	Description
Challenge Method	<p>One challenge method must be selected from those listed as available:</p> <ul style="list-style-type: none"> • Form • Basic (LDAP) • X509 (Certificate) • WNA (Windows Native Authentication) • None • DAP • OAM10g <p>See Also: "Credential Challenge Methods"</p>
Challenge Redirect URL	<p>This URL declares the end point referencing the Credential Collector (ECC or DCC). For example:</p> <p>ECC: <code>/oam/server</code></p> <p>DCC: <code>http://<dcc-host:port>/</code></p> <p>See Also:</p> <ul style="list-style-type: none"> • "About Host Identifiers" • Configuring 11g WebGate and Authentication Policy for DCC
Authentication Module	<p>Identifies the pre-configured authentication module to be used to challenge the user for credentials. The module or plug-in specified here identifies the exact user identity store to be used.</p> <ul style="list-style-type: none"> • FederationMTPlugin • FederationPlugin • Kerberos Plugin (Authentication Modules and Custom Authentication Module) • MTLDAPBasic • MTLDAPPlugin • OIFMTLDAPPlugin • Password Policy Validation Module • TAPModule • X509 Plugin (under the X509 Authentication Modules node) <p>See Also "Managing Native Authentication Modules" and "Orchestrating Multi-Step Authentication with Plug-in Based Modules".</p>
Challenge URL	<p>This URL is associated with the designated Challenge Method (FORM, for instance).</p> <p>FORM-based, out of the box authentication scheme (LDAPScheme and LDAPNoPasswordValidationScheme), Challenge URL is <code>/pages/login.jsp</code>. The context type and context values are used to build the final URL.</p> <p>X509-based Challenge URL takes the form: <code>https://managed_server_host:managed_server_ssl_port/oam/CredCollectServlet/X509</code></p> <p>Note: The default Challenge URL is based on the credential collector embedded with the OAM Server (ECC). If you are using detached credential collector-enabled Webgate and related DCC pages installed with WebGate, see Configuring 11g WebGate and Authentication Policy for DCC.</p>

Table 22-20 (Cont.) Authentication Scheme Definition

Element	Description
Challenge Parameters	Supported challenge parameters are discussed in " Challenge Parameters for Authentication Schemes ".
For schemes using Challenge Method FORM, X509, or DAP	Only Schemes with the Challenge Method of FORM, X509, or DAP include the following additional elements. Other schemes use defaults that require no change.
Context Type	<p>Used to build the final URL for the Embedded Credential Collector (ECC only, DCC does not use this) based on the following possible values:</p> <ul style="list-style-type: none"> default: The Context Value is used to construct the final URL to forward to for credential collection. For example: with a challenge URL of "/pages/login.jsp" and a context value of /oam, the server forwards to "/oam/pages/login.jsp" for credential collection by the ECC. customWar: If a customized credential collector page "customlogin.jsp" is deployed in a WAR file (with context root, "custom") within the same domain, it should be used to collect credentials. Then set the following values to have server forward to the WEB application page "/custom/customlogin.jsp" to collect credentials: <pre>challenge_url = "/customlogin.jsp" contextType="customWar" contextValue="/contextroot of custom application"</pre> customHtml: A custom html credential collector page. This file can be placed in a location that is accessible to the application. Set the following values to have the server forward to the custom servlet provided to read the html file and render the page: <pre>challenge_url = "/CustomReadServlet" contextType="customHtml" contextValue="html file location"</pre> external: If the login page is external, the file can be placed in a location that is accessible to the application. Set the following values to have the server redirect to the challenge URL (the fully-qualified URL of the external credential collector page) for credential collection. The username and password are collected by the external form (HTML or jsp) and submitted to the OAM Server: <pre>challenge_url = "http://host:port/externallogin.jsp" contextType="external" contextValue=Not applicable</pre> <p>See Also: "About Custom Login Pages" and Managing Global Password Policy</p>
Context Value	Used to build the final URL for the credential collector. The default value is /oam.

About Custom Login Pages

Only Schemes with the Challenge Method of FORM, X509, or DAP include additional elements described at the end of [Table 22-20](#). All custom login pages must meet the following requirements:

- Custom login pages require two form fields (username and password). Access Manager supports custom forms as described in *Oracle Fusion Middleware Developer's Guide for Oracle Access Management*.
- CustomWar and external context types, require logic within the custom login page to perform the following two tasks:
 - Send back the request ID the page received from the Access Manager server. For example: `String reqId = request.getParameter("request_id"); <input type="hidden" name="request_id" value="<%=reqId%>">`
 - Submit back to the OAM Server the end point, `/oam/server/auth_cred_submit`. For example: `<form action="/oam/server/auth_cred_submit">` or `"http://oamserverhost:port/oam/server/auth_cred_submit"`.

For more information, see the following topics:

- [Pre-configured Authentication Schemes](#)
- [Credential Challenge Methods](#)
- [Challenge Parameters for Authentication Schemes](#)

See Also:

Oracle Fusion Middleware Developer's Guide for Oracle Access Management for details about customizing login pages and messages.

22.9.1.1 Pre-configured Authentication Schemes

Pre-configured Authentication Schemes such as BasicFAScheme and KerberosScheme are available with Access Manager.

"[Table 22-21](#)" identifies the pre-configured authentication schemes available with Access Manager and some specific details of each. For more information about challenge parameters, see "[Table 22-21](#)".

Table 22-21 Pre-configured Authentication Schemes

Scheme Name	Specifications	Purpose
AnonymousScheme	Authentication Level: 0 Challenge Method: None Authentication Module: Anonymous Module	Leaves unprotected specific Access Manager URLs and allows users to access such URLs without a challenge. Users are not challenged and do not need to enter their credentials. Note: Authentication Level 0 is for public pages. Oracle recommends that you do not use Level: 0 in a custom authentication scheme. Also: When a resource is protected by AnonymousScheme, it is not displayed in a session search.
BasicFAScheme Only for Oracle Fusion Applications	For Fusion Applications	For specific information about this authentication scheme, refer to the Oracle Fusion Applications Technology Library located on the Oracle Technology Network (OTN) web site: http://www.oracle.com/technetwork
BasicScheme	Authentication Level: 1 Challenge Method: Basic Authentication Module: LDAP	Protects Access Manager-related resources (URLs) for most directory types. Note: Authentication Level 1 is only one step higher than 0 public pages. Oracle recommends that you do not use Level: 1 in a custom authentication scheme.
BasicSessionlessScheme	Authentication Level: 1 Challenge Method: Basic Authentication Module: LDAP	Primarily used for clients that don't support URL redirect or cookies. Challenge Parameters: CookieLessMode=true Note: Authentication Level 1 is only one step higher than 0 public pages. Oracle recommends that you do not use Level: 1 in a custom authentication scheme.
FAAuthScheme Only for Oracle Fusion Applications	Authentication Level: 2 Challenge Method: FORM Authentication Module: LDAP Context: customWar Context Value: /fusion_apps	For specific information about this authentication scheme, refer to the Oracle Fusion Applications Technology Library located on the Oracle Technology Network (OTN) web site: http://www.oracle.com/technetwork

Table 22-21 (Cont.) Pre-configured Authentication Schemes

Scheme Name	Specifications	Purpose
FederationMTScheme Only for Oracle Fusion Applications	Authentication Level: 2 Challenge Method: FORM Authentication Module: FederationMTPlugin Context Type: customWar Context Value: /fusion_apps Challenge Parameters: initial_command=NONE is_rsa=true	For specific information about this authentication scheme, refer to the Oracle Fusion Applications Technology Library located on the Oracle Technology Network (OTN) web site: http://www.oracle.com/technetwork See Also: " Challenge Parameters for Authentication Schemes ".
FederationScheme Only for Identity Federation 11.1.2.	Authentication Level: 2 Challenge Method: FORM Authentication Module: FederationPlugin Context Type: customWar Context Value: /oam Challenge Parameters: initial_command=NONE is_rsa=true	See Also: Managing Oracle Access Management Identity Federation .

Table 22-21 (Cont.) Pre-configured Authentication Schemes

Scheme Name	Specifications	Purpose
KerberosScheme	Authentication Level: 2 Challenge Method: WNA Authentication Module: Kerberos Context Type: customWar Context Value: /fusion_apps	Protects Access Manager-related resources (URLs) for most directory types based on a Windows Native Authentication challenge method and valid WNA credentials in Active Directory.
LDAPNoPasswordValidationScheme	Authentication Level: 2 Challenge Method: FORM Authentication Module: LDAPNoPasswordAuthModule Context Type: default Context Value: /oam	Protects Access Manager-related resources (URLs) for most directory types based on a form challenge method. Used with the Identity Asserter for SSO when you have resources in a WebLogic Container. See <i>Securing Applications with Oracle Platform Security Services</i> .
	<p>Note: LDAPNoPasswordAuthModule is similar to the DAP (asserter) mechanism.</p> <p>See Also OAM10gScheme, later in this table.</p>	

Table 22-21 (Cont.) Pre-configured Authentication Schemes

Scheme Name	Specifications	Purpose
LDAPScheme	<p>Authentication Level: 2</p> <p>Challenge Method: FORM</p> <p>Authentication Module: LDAP</p> <p>Context Type: customWar</p> <p>Context Value: /fusion_apps</p>	<p>Protects Access Manager-related resources (URLs) for most directory types based on a form challenge method.</p>
OAAM Advanced	<p>Authentication Level: 2</p> <p>Challenge Method: FORM</p> <p>Authentication Module: LDAP</p> <p>Context Type: external</p>	<p>Protects OAAM-related resources with an external context type. This authentication scheme is used when complete integration with OAAM is required. A Webgate must front ending the partner.</p>
OAAM Basic	<p>Authentication Level: 2</p> <p>Challenge Method: FORM</p> <p>Authentication Module: LDAP</p> <p>Context Type: default</p> <p>Context Value: /oam</p> <p>Challenge Parameters oaamPostAuth=true oaamPreAuth=true</p>	<p>Protects OAAM-related resources with a default context type. This scheme should be used when basic integration with OAAM is required. Here, advanced features like OTP are not supported. This is more of an integration when mod_osso is used as the agent.</p>

Table 22-21 (Cont.) Pre-configured Authentication Schemes

Scheme Name	Specifications	Purpose
OAM10gScheme	Authentication Level: 2 Challenge Method: OAM10G Authentication Module: LDAPNoPasswordAuthModule	Facilitates integration and coexistence with Oracle Access Manager 10g. In the coexistence mode, Oracle Access Manager 10g is the authenticator and Access Manager 11g is the asserter. This scheme requires challenge mechanism OAM10G, specifically for OAM10g coexistence with OSSO as described in " OAM10G ".
	See Also LDAPNoPasswordValidationScheme, earlier in this table. enableCoexistMode and disableCoexistMode in the Oracle Fusion Middleware WebLogic Scripting Tool Command Reference.	
OAMAdminConsoleScheme	Authentication Level: 2 Challenge Method: FORM Authentication Module: LDAP Context Type: default Context Value: /oam	Authentication scheme for Oracle Access Management Console.

Table 22-21 (Cont.) Pre-configured Authentication Schemes

Scheme Name	Specifications	Purpose
OICScheme	Authentication Level: 2 Challenge Method: DAP Authentication Module: TAPModule Context Type: External Challenge Parameters: TAPPartnerId=RPPartner MatchLDAP Attribute=email	Access Manager uses this scheme to delegate authentication to Mobile and Social services and redirects the user to the Mobile and Social login page for authentication. See Also: Managing Oracle Access Management Mobile and Social
OIFScheme Only for Oracle Identity Federation 11.1.1. For Oracle Identity Federation 11.1.2, use FederationScheme.	Authentication Level: 2 Challenge Method: DAP Authentication Module: DAP Context Type: External	This scheme delegates authentication to OIF, after which, Oracle Identity Federation sends back a token that is asserted by the OAM Server. The Delegated Authentication Protocol (DAP) challenge method is used to delegate authentication to a third-party (OIF in this case). Challenge Parameters: TAPPartnerId=OIFDAPPartner See Also: " Challenge Parameters for Authentication Schemes ".

Table 22-21 (Cont.) Pre-configured Authentication Schemes

Scheme Name	Specifications	Purpose
OIMScheme	Authentication Level: 1 Challenge Method: FORM Authentication Module: LDAP	Protects Oracle Identity Manager-related resources with a default context type. Note: When integrating OAM and OIM, OAM downgrades the user's authentication level when any of the following is detected: password expiry forced password change challenge setup not done This enables the user to access the pages only after performing necessary operations in the identity management (OIM) page to which the user is redirected. At Level 1, only public and OIM pages for the required operations can be accessed. Note: Authentication Level 1 is only one step higher than 0 public pages. Oracle recommends that you do not use Level: 1 in a custom authentication scheme.
		Set as the Default authentication scheme for environments that have been migrated from OSSO 10g to Access Manager 11g.
PasswordPolicyValidationScheme	Authentication Level: 2 Challenge Method: FORM Authentication Module: Password Policy Validation Module Context: External	Enables password policy evaluation.
TAPResponseOnlyScheme	Authentication Level: 2 Challenge Method: DAP Authentication Module: DAP	

Table 22-21 (Cont.) Pre-configured Authentication Schemes

Scheme Name	Specifications	Purpose
TAPScheme	Authentication Level: 2 Challenge Method: DAP Authentication Module: DAP Context Type: External	To use TAPScheme for IDM product resources in the IAM Suite Application Domain, Protected Higher Level Policy, the following configuration must be done in addition to changing the Authentication Scheme. <ol style="list-style-type: none"> From the IAM Suite Application Domain, Protected Higher Level Policy, remove IAMSuiteAgent:/oamTAPAuthenticate. Create a new Authentication Policy in the IAM Suite Application Domain, that uses LDAPScheme. Protect IAMSuiteAgent:/oamTAPAuthenticate using the newly created policy. Challenge Parameters: TAPPartnerId=TAPPartnerName
X509Scheme	Authentication Level: 5 Challenge Method: X509 Authentication Module: X509	This authentication scheme is a certificate-based user identification method. To use this method, a certificate must be installed on the user's browser and the Web server must be SSL-enabled. Note: This scheme relies on SSL to deliver the use's X.509 certificate to the OAM Server.

22.9.1.2 Credential Challenge Methods

Authentication involves determining what credentials a user must supply when requesting access to a resource, gathering credentials over HTTP, and returning an HTTP response that is based on the results of credential validation.

Access Manager provides the following credential challenge methods for use in an authentication scheme:

- [FORM](#)
- [BASIC](#)
- [X509](#)
- [WNA](#)
- [NONE](#)
- [DAP](#)
- [OAM10G](#)

FORM

This authentication challenge uses an HTML form with one or more text input fields for user credentials. In a typical form-based challenge, users enter a user name and password in two text boxes on the form. The most common credential choices are user name and password; however, you can use any user attributes: for example, user name, password, and domain.

A Submit button posts the content of the form. When the user clicks the Submit button, the form data is posted to the Web server. Upon validation of the user credentials collected in the form, the user is authenticated.

Note:

This challenge method relies on an LDAP Authentication Module and the user identity store associated with that module.

You might want to use form-based authentication challenge for reasons such as:

- A consistent user experience: Using form-based login and a standardized logout means that the user experience for login and logout features will be consistent across browsers.
- A Custom Form: You can apply your organization's look and feel in the authentication process.

For example, a custom form can include a company logo and a welcome message instead of the standard user name and password window used in Basic authentication.

- Additional Information: You can gather additional information at the time of login.
- Additional Functionality: You can provide additional functionality with the login procedure, such as a link to a page for lost password management.

BASIC

This built-in Web server challenge mechanism requires a user to enter her login ID and password. The credentials supplied are compared to the user's definition in the LDAP directory server. Thus, a Basic challenge relies on the LDAP Authentication Module and user identity store associated with that module.

Note:

If a URL is protected by Access Manager using Basic Authentication with OID configured as the identity store, OID defined users can not log in. To resolve this, add the following line before the closing `</security-configuration>` tag in the `config.xml` file.

```
<enforce-valid-basic-auth-credentials>false
  </enforce-valid-basic-auth-credentials>
```

X509

With the X509 certificate challenge method, a user's browser must supply an X.509 digital certificate over SSL to the OAM Server through the Agent to perform authentication.

Note:

X509 is the challenge method for the X509Scheme. The user's organization can determine how to obtain a certificate.

The X.509 client certificate must be verified against the trusted CAs in the keystore used by OAM Proxy and OAM Servers to ensure the validity of X.509 Client certificate for authentication.

The following attributes of the X.509 certificate can be validated against the user identity store associated with Access Manager:

- SubjectDN
- SubjectUniqueID
- Mail
- CN

To acquire the user entry, the X509 Authentication Module takes the attribute name of the X.509 certificate to be validated and the LDAP attribute against which the search will be launched. The expected result is the single user entry matching the criteria. If the search returns no user entry, or more than one entry, authentication fails. Authentication scheme parameters are located in oam-policy.xml.

Note:

For X509 authentication, Administrators must configure the Oracle HTTP Server as a reverse proxy (or a server with the wl-proxy plug-in). The Oracle HTTP Server must be configured in two way SSL Mode to acquire X.509 certificate for authentication. Oracle HTTP Server can also be configured for CRL verification.

The online certificate status protocol (OCSP) capabilities are also provided. Any certificate passed for X.509 certificate-based authentication is validated using an OCSP request. Administrators can configure the system to communicate with one or more OCSP servers to retrieve the certificate status.

The X509 Authentication Module configuration for the OCSP responder URL indicates whether OCSP validation is to be done. The value, if specified, indicates the URL for validation of the X.509 client certificate using OCSP. No value indicates no OCSP validation.

WNA

Uses Windows Native Authentication with Active Directory, and the Kerberos Authentication Module.

Note:

The KerbScheme relies on the WNA challenge method and Kerberos Authentication Module.

See Also:

[Configuring Access Manager for Windows Native Authentication](#) for details about integration with Windows Native Authentication

NONE

The challenge method of None means that users are not challenged and do not need to enter their credentials. This is used in the AnonymousScheme authentication scheme, which allows users to access Access Manager-specific URLs that you do not want to protect.

DAP

The Delegated Authentication Protocol (DAP) challenge method is required for OIFScheme (Oracle Identity Federation 11.1.1 integration) with the DAP authentication module and external context type (Table 22-20). The DAP challenge mechanism indicates that Access Manager does an assertion of the token that it receives, which differs from the standard challenge "FORM" mechanism with the external option.

DAPModule is an assertion module, though it is specialized for this one application and does not appear in the list of Authentication Modules in the Oracle Access Management Console. This integration replaces OSSO 10g with Access Manager 11g, with no changes from the Identity Federation side.

The DAP challenge mechanism delegates authentication to a third party (Identity Federation in this case). The challenge_url points to the Identity Federation Server URL. When a resource is protected by this scheme, the OAM Server redirects to the Identity Federation Server URL for credential collection. OAM Server does not perform the credential collection or validation in this case. Identity Federation collects the credentials, authenticates the user against its identity store and returns an assertion token to the OAM Server consisting of the username. Access Manager receives and decrypts this token, checks whether the user is a valid user in the default identity store for Oracle Access Management. If the user is valid, Access Manager gives access to the resource.

The DAPToken is encrypted and decrypted with a key that is shared between Access Manager and Identity Federation. The DAPToken is built from the Access Manager side.

The Identity Federation Administration EM Console provides a way to generate the keystore containing the encryption keys that will be used to secure communications between the Access Manager and Identity Federation. Access Manager provides a WLST command (`registerOIFDAPPartner`), that takes the keystore location generated by the Identity Federation store and retrieves the keys and stores it on the Identity Federation side.

OAM10G

DOC: Create version 2 of this topic before making 12C specific changes here.

This mechanism is created for Oracle Access Manager 10g coexistence with OSSO 10g. The OAM10G method always acts as the authentication and authorization provider and is required for OAM10gScheme with the LDAPNoPasswordAuthModule to facilitate trust when you have Oracle Access Manager 10g protecting a domain that also includes an OSSO 10g integrated classic application (Portal, Disco, and so on).

OSSO10g is protected with OAM10G challenge method through Webgate; OAM10G always acts as the authentication and authorization provider.

Facilitating Integration: The OSSO 10g integrated classic applications can be upgraded to Access Manager, which then acts only as an asserter. Access Manager creates the tokens that mod_osso can consume so that access can be provided to these applications. The mod_osso applications are protected by the new "OAM10gScheme". There is a Webgate front ending the OAM Server and configured against the 10g Access Server.

Setup: When the resource is accessed, Webgate intercepts the request and sends it to the 10g Access Server for authentication. Oracle Access Manager 10g collects the credentials, validates it against its identity store, and sets the username as a header variable (OAM_REMOTE_USER). The request now goes to the OAM Server which uses the OAM10gScheme to locate the username in the header variable. Access Manager retrieves the header variable and asserts the presence of the user against the primary identity store. If present, the required cookies (OAM_ID) are generated and redirected to the resource.

See Also:

- OAM10gScheme in [Table 22-21](#)
 - enableCoexistMode and disableCoexistMode in the Oracle Fusion Middleware WebLogic Scripting Tool Command Reference
-

22.9.1.3 Challenge Parameters for Authentication Schemes

Challenge parameters are short text strings consumed and interpreted by Webgates and Credential Collector modules to operate in the manner indicated by those values.

The syntax for specifying any challenge parameter is:

`<paramatename>=<value>`

This syntax is not specific to any Webgate release (10g versus 11g). Authentication schemes are independent of Webgate release.

[Table 22-22](#) identifies the pre-configured schemes with challenge parameters.

Table 22-22 Challenge Parameters in Pre-configured Schemes

Pre-configured Schemes	Challenge Parameter
BasicSessionlessScheme	CookieLessMode=true Primarily used for clients that do not support URL redirect or cookies.

Table 22-22 (Cont.) Challenge Parameters in Pre-configured Schemes

Pre-configured Schemes	Challenge Parameter
FederationMTScheme	<p>initial_command=NONE</p> <p>Primarily used for Fusion Applications that support multiple factor authentication.</p> <p>is_rsa=true</p> <p>Used with RSA multi-step authentication, as described in Integrating RSA SecurID Authentication with Access Manager and the <i>Oracle Fusion Middleware Developer's Guide for Oracle Access Management</i>.</p>
FederationScheme For Identity Federation 11.1.2.only. Use OIFScheme for Oracle Identify Federation 11.1.1.	<p>Primarily used for clients that do not support URL redirect or cookies.</p> <p>Context Value: /fusion_apps Challenge Parameters: initial_command=NONE is_rsa=true</p> <p>Primarily used for clients that do not support URL redirect or cookies.</p>
OAAMBasic	<p>oaamPostAuth=true oaamPreAuth=true</p> <p>Protects OAAM-related resources. These parameters should be used when basic integration with OAAM is required.</p>
OIFScheme For Oracle Identify Federation 11.1.1 only. Use FederationScheme for Identity Federation 11.1.2.	<p>TAPPartnerId=OIFDAPPartner</p> <p>This scheme delegates authentication to Oracle Identity Federation 11.1.1, after which, Federation sends back a token that is asserted by the OAM Server.</p>
TapScheme	TAPPartnerId=TAPPartnerName

An authentication scheme can collect context-specific information before submitting the request to the Access Server. Context-specific information can be in the form of an external call for information. [Table 22-23](#) lists user-defined challenge parameters you can use in Authentication Schemes.

Table 22-23 User-Defined Challenge Parameters for Authentication Schemes

Challenge Parameter	Definition
initial_command=NONE	<p>Required to enable the plug-in to indicate which credentials are to be collected.</p> <p>For example, for Form-based authentication, the framework typically expects to collect "username" and "password" (submitted from the login page). However, you might want credentials from different fields of the login page; "form_username" and "form_password" for example. Setting this challenge parameter shifts initial control from the login page to the plug-in, which decides the parameters to collect from the login page then appropriately forwards or redirects to the page.</p> <p>Default: blank (not set)</p>

Table 22-23 (Cont.) User-Defined Challenge Parameters for Authentication Schemes

Challenge Parameter	Definition
action=	<p>The actions parameter identifies the URL to which the HTML form is posting when you do not want to use the hard coded ECC default <code>/oam/server/auth_cred_submit</code>.</p> <p>Note: ECC does not use the <code>action=</code> parameter. When the <code>action=</code> challenge parameter is not specified, both the DCC and ECC use the default: <code>/oam/server/auth_cred_submit</code>.</p> <p>See Also: "Configuring the PasswordPolicyValidationScheme "</p>
creds= <i>DCC Only</i>	<p>Supported by the detached credential collector (DCC) only.</p> <p>In the following 11g example, username and password are the names of relevant fields in the login form:</p> <pre>creds=username password</pre> <p>NOTE: Format of this challenge parameter has changed since the 10g release.</p> <p>The Web server source (server parameter) takes precedence over other sources. This prevents the request data, which is under control of the user, from overriding Web server data. For example, a <code>remote_user</code> cookie sent from a user will not override a <code>remote_user</code> variable set by the Web server</p> <p>Generally, when the user submits a login form that is protected by an authentication scheme with a Form-based challenge method, the DCC processes the credentials that were specified with this <code>creds=</code> parameter.</p> <p>For forms using <code>METHOD=POST</code> processing, the browser sends a POST request to the Web server with the credential data from the form in the body of the request. If the form uses <code>METHOD=GET</code>, the browser sends a GET request with query string parameters with the same names as those specified on the <code>creds</code> parameter. Oracle recommends that you use POST processing, if possible.</p> <p>Note: You can specify the <code>creds</code> parameter with the other types of challenge methods. For a plug-in to make use of the <code>creds</code> parameter, you specify what is passed in the <code>obMap</code> credentials parameter of the <code>ObUserSession</code> object, as described in the <i>Oracle Fusion Middleware Developer's Guide for Oracle Access Management</i>.</p> <p>See Also: "Configuring the PasswordPolicyValidationScheme "</p>
extracreds= <i>DCC Only</i>	<p>Supported by the DCC only. Specifies optional parameters which, if present, are made available to the authentication plug-in for collection during each iteration of a multi-step authentication using the DCC.</p> <p>The <code>extracreds</code> parameter uses the same syntax as the <code>creds</code> parameter: <code>extracreds= separated qualified or unqualified names [{any cookie header server query post}:] <name></code>. However, the value <code>any</code> is used by <code>extracreds</code> only. For example:</p> <pre>extracreds=[{any cookie header server query post}:] <name></pre> <p>See Also: "Configuring the PasswordPolicyValidationScheme "</p>
OverrideRetryLimit=0	<p>The number of tries that can override the <code>RetryLimit</code> for login.</p> <p>The value must be a positive integer.</p> <p>A value of zero (0) disables this function.</p> <p>See Also: "Configuring the PasswordPolicyValidationScheme "</p>

Table 22-23 (Cont.) User-Defined Challenge Parameters for Authentication Schemes

Challenge Parameter	Definition
ChallengeRedirectMethod	<p>Authentication POST data preservation parameter for both the embedded credential collector (ECC) and the detached credential collector (DCC).</p> <p>Value: GET POST DYNAMIC</p> <p>Note: Preference is given first to the Authentication Scheme containing this parameter; second to the Webgate providing this user defined parameter. Otherwise, default behavior is Dynamic.</p> <p>See Also: "Configuring Authentication POST Data Handling" Table 15-2</p>
MaxPreservedPostDataBytes	<p>Configure this Authentication Scheme challenge parameter (or user-defined Webgate parameter) for authentication POST-data preservation.</p> <p>Default: 8192 bytes</p> <p>Note: Preference is given first to the Authentication Scheme containing this parameter; second to the Webgate providing this user-defined parameter. Otherwise, default behavior is 8192 bytes.</p> <p>This parameter defines the maximum length of POST data that Webgate can preserve. If the size of inbound raw user POST data (or encrypted post data after processing), crosses this limit, POST data is dropped and the existing authentication flow continues. The event is logged as usual.</p> <p>See Also: "Configuring Authentication POST Data Handling" Table 15-2</p>
MaxPostDataBytes= <i>DCC Only</i>	<p>Configure this Authentication Scheme challenge parameter to restrict the maximum number of bytes of POST data that is submitted as user credentials and sent to the OAM Server.</p> <p>Configure this challenge parameter for POST-data preservation by the DCC only to limit the maximum size of the POST data that can be posted as credentials on the form and sent to the OAM Server. DCC compares the value of the content-length header with the limit set.</p> <p>Default: 8192 bytes</p> <p>This challenge parameter requires a positive integer value.</p> <p>See Also: Table 15-2 "Configuring the PasswordPolicyValidationScheme " "Configuring Authentication POST Data Handling"</p>

Table 22-23 (Cont.) User-Defined Challenge Parameters for Authentication Schemes

Challenge Parameter	Definition
ssoCookie=	<p>Controls the OAMAuthnCookie cookie, as described in "Configuring Challenge Parameters for Encrypted Cookies".</p> <p>Default: ssoCookie=httponly ssoCookie=Secure</p> <p>Disable either setting: ssoCookie=disablehttponly ssoCookie=disableSecure</p> <p>Note: These parameters are configured differently depending on your credential collector configuration.</p> <ul style="list-style-type: none"> For detached credential collector-enabled 11g Webgates, set these parameters directly in the agent registration page. For non-DCC agents (Resource Webgates), these parameters are configured through user-defined challenge parameters in authentication schemes. <p>See Also: Table 22-30</p>
miscCookies=	<p>Controls other miscellaneous Access Manager internal cookies. By default, httponly is enabled for all other (miscellaneous) cookies.</p> <p>Default: miscCookies=httponly miscCookies=Secure</p> <p>Disable either setting: miscCookies=disablehttponly miscCookies=disableSecure</p> <p>Note: These parameters are configured differently depending on your credential collector configuration.</p> <ul style="list-style-type: none"> For detached credential collector-enabled Webgates, set these parameters directly in the agent registration page. For non-DCC agents (Resource Webgates), these parameters are configured through challenge parameters of the same name. <p>See Also: Table 22-30 "Configuring the PasswordPolicyValidationScheme "</p>
DCCctxCookieMaxLengt h= <i>DCC Only</i>	<p>Defines the maximum length of the DCC cookie.</p> <p>Default: 4096</p> <p>See Also: TempStateMode in this table for more information.</p>

Table 22-23 (Cont.) User-Defined Challenge Parameters for Authentication Schemes

Challenge Parameter	Definition
TempStateMode=	<p>Controls how the DCC stores the OAM Server state (cookie or form) as specified with the parameter's value:</p> <ul style="list-style-type: none"> form: This is the default, and is required for retaining authentication POST data. The OAM Server state stored and passed through the form parameter "OAM_REQ", to avoid the case when the OAM Server configuration <code>serverRequestCacheType=COOKIE</code>, bloated server state causes DCCtxCookie to explode beyond limit resulting in incorrect behavior. The cookie cache mode can be changed to FORM mode from default COOKIE mode. FORM mode works with long URLs. The only difference in behavior is for programmatic authentication, which requires a proper form Submit to pass the OAM_REQ parameter set to the form. Custom credential collection pages need to handle the OAM_REQ parameter that is submitted with the form. cookie: Adding this parameter and value stores the OAM Server state through part of the DCCtxCookie (<code>encdata=... svrctx=...</code>). However, when <code>serverRequestCacheType=COOKIE</code> or <code>=FORM</code>, this could cause incorrect behavior if the resulting cookie length is beyond browser limit. <p>Note:</p> <ul style="list-style-type: none"> When <code>serverRequestCacheType=COOKIE</code>, Oracle recommends <code>TempStateMode=form</code>. When <code>serverRequestCacheType=BASIC</code>, either mode is fine. <p>To update <code>serverRequestCacheType</code>, use the WLST command <code>configRequestCacheType</code> as described in the <i>WLST Command Reference for WebLogic Server</i>. Editing <code>serverRequestCacheType</code> is not supported using the Oracle Access Management Console.</p> <p>With ECC: The <code>serverRequestCacheType</code> dictates whether OAM Server stores its state in memory (BASIC) or not (FORM or COOKIE). <code>serverRequestCacheType = COOKIE</code> or <code>FORM</code> only makes difference when ECC is used. OAM Server stores its state in a request token, which ECC keeps in a cookie or hidden form field as specified with the parameter: <code>serverRequestCacheType=COOKIE</code>, for example.</p> <p>With DCC: There is no difference between <code>serverRequestCacheType=COOKIE</code> or <code>FORM</code>. <code>TempStateMode</code> controls how the DCC stores the OAM Server state (cookie or form) as specified with the parameter's value: <code>TempStateMode=cookie</code>, for example. With the DCC, POST data restoration with a Form-based Authentication Scheme requires the challenge parameter TempStateMode=form.</p> <p>See Also:</p> <ul style="list-style-type: none"> Configuring 11g WebGate and Authentication Policy for DCC Table 15-2 "Table 22-32" "Configuring the PasswordPolicyValidationScheme"
allowedAccessGateList=	<p>Authentication Scheme challenge parameter configured with SPACE separated list of WebGate IDs defining those WebGates that are allowed to enforce authentication by this scheme. For example:</p> <pre>allowedAccessGateList=WebgateID1 WebgateID2</pre>
TunneledUrls	<ul style="list-style-type: none"> For OAM : <code>TunneledUrls=/oam</code> For OAAM : <code>TunneledUrls=/oam/server/obrareq.cgi,/oam/server/dap/cred_submit</code> For OIF : <code>TunneledUrls=/oamfed</code> For OIM : <code>TunneledUrls=/oam</code>

22.9.2 Understanding Multi-Level and Step-Up Authentication

This section provides the following topics:

- [About Multi-Level and Step-Up Authentication](#)
- [Detection of Insufficient Authentication Level by OAM Agent](#)
- [Multi-Level Authentication Processing with 10g OSSO Agent](#)
- [Changing Security Level of an Authentication Scheme during the Authentication Process](#)

22.9.2.1 About Multi-Level and Step-Up Authentication

Every authentication scheme requires a strength level. The higher the number, the more secure the authentication mechanism; the lower the number, the less stringent the scheme.

For example:

- LDAPScheme authLevel=1
- KerbScheme authLevel=3

Note:

Multi-level authentication does not affect, negate, or alter X.509 certificate authentication.

SSO capability enables users to access more than one protected resource or application with a single sign in. After a successful user authentication at a specific level, the user can access one or more resources protected by one or more Application Domains. However, the authentication schemes used by the Application Domains must be at the same level (or lower). When a user accesses a resource protected with an authentication level that is greater than the level of his current SSO token, he is re-authenticated. In the step-up case, the user maintains his current level of access even if failing the challenge presented for the higher level. This is "additional authentication".

Note:

A user who is authenticated to access resources at level 3, is eligible to access resources protected at levels less than or equal to 3. However, if the user is authenticated to access resources at level 2 and then attempts to access resources protected by level 3, the user is asked to re-authenticate (this is known as step-up authentication).

Access Manager policies allow different resources of the same application to be protected with different authentication levels.

In such cases, the application must enforce the Level and send the Dynamic Directive to mod_osso for re-authentication. On receiving the Dynamic Directive, mod_osso will redirect to Access Manager for re-authentication at the appropriate level.

Both agent types redirect the user to the OAM Server to authenticate again. The challenge is presented according to the level of the authentication scheme configured in the policy for the resource.

Registered agents detect the authentication level as follows:

- OAM Agents receive an insufficient level error message from the OAM Server, as described in "[Detection of Insufficient Authentication Level by OAM Agent](#)".
- mod_osso detects the authentication level from dynamic directives, as described in [Multi-Level Authentication Processing with 10g OSSO Agent](#).

Note:

mod_osso delegates authentication to Access Manager. Oracle recommends that mod_osso-protected resources be protected with Access Manager authentication levels. The mod_osso plug-in does not support two resources on the same application with a different trust level.

See Also:

; for example, the chapter Integrating Access Manager and Oracle Adaptive Access Manager. The user was already authenticated when he accessed another resource with a lower authentication level using Access Manager. Oracle Adaptive Access Manager does not show the user name and password pages because the user is already authenticated. However, the flows that are executed in Oracle Adaptive Access Manager depend on whether the user was already logged in to Oracle Adaptive Access Manager.

22.9.2.2 Detection of Insufficient Authentication Level by OAM Agent

When the user requests a resource that is protected with a higher level authentication scheme, the following process occurs.

See Also:

["Understanding Authentication Methods and Credential Collectors"](#)

Process overview: OAM Agent detects insufficient session level

No check of the authentication level is made on the server side. The following example refers to a 10g OAM Agent.

Note:

11g OAM Agents are associated with individual per-agent OAMAuthnCookies.

1. The OAM Agent sends the request to the OAM Proxy to obtain the scheme details for the protected resource.
2. The OAM Agent sends the request for session information to the OAM Proxy.

3. The OAM Proxy returns details of the ObSSOCookie, including the authenticated level of the ObSSOCookie.
4. The OAM Agent compares the level of ObSSOCookie with that of the authentication scheme.
 - If insufficient, the agent invokes the authentication process again.
 - If sufficient, the access is granted access.

22.9.2.3 Changing Security Level of an Authentication Scheme during the Authentication Process

You can write a custom plug-in to change the security level of an authentication scheme during the authentication process.

In some cases, you may want to increase the security level of an authentication scheme during the authentication process depending on certain conditions. You may want the security level of an authentication scheme to depend on the application the user logged in from. For example, Active Directory and a reverse proxy are among the sources your users can log in from. During the authentication process, you may want to dynamically set one authentication security level to be used for users who log in from Active Directory and another security level to be used for users who log in from the reverse proxy.

Enable custom authentication plug-ins to set the authentication level as a plug-in response. Write a new custom authentication plug-in where a configurable authentication level is set as a plug-in step parameter in the plug-in response. For example, `PLUGIN_AUTHN_LEVEL` is configured in the plug-in response. It helps set the authentication level dynamically based on the authentication mechanism used.

To avoid any security implications resulting from the custom plug-in, use an optional authentication scheme challenge parameter, `MAX_AUTHN_LEVEL`. The value of `MAX_AUTHN_LEVEL` is the maximum authentication level that can be set by a custom authentication plug-in protecting resources. In the custom authentication scheme, this parameter is disabled by default. You need to set this mandatory parameter with a higher value than the `PLUGIN_AUTHN_LEVEL` for the plug-in to dynamically change the value of authentication level during the authentication process.

Write a custom authentication plug-in and configure `KEY_AUTHN_LEVEL` with a value lower than `MAX_AUTHN_LEVEL`. Create a custom authentication module that uses the new authentication plug-in and associate it with the Custom Authentication Scheme. Specify the Scheme in Authentication policy protecting the resource. When the user session is created, warning message about the plug-in overriding the maximum authentication value set by the administrator is logged by OAM server. When `MAX_AUTHN_LEVEL` is not configured or the plug-in tries to set value greater than `MAX_AUTHN_LEVEL`, the authentication succeeds with the authentication level set in the authentication scheme.

Following is the sample code to set authentication level as a plug-in response:

```
String stepName = context.getStringAttribute(PluginConstants.KEY_STEP_NAME);
String pluginLevel = PlugInUtil.getFlowParam(stepName, " PLUGIN_AUTHN_LEVEL ",
context);
PluginResponse rsp = new PluginResponse();
rsp.setName(PluginConstants.KEY_AUTHN_LEVEL);
rsp.setType(PluginAttributeContextType.LITERAL);
rsp.setValue(pluginLevel);
context.addResponse(rsp);
```

22.9.2.4 Multi-Level Authentication Processing with 10g OSSO Agent

In contrast to OAM Agents, all the resources protected by `mod_osso` on a host (or virtual host) are protected at the same level. With `mod_osso`, multi-level authentication applies when user is already authenticated using one `mod_osso` host (or virtual host) at Level 2 and then tries to access another `mod_osso` protected host (or virtual host) at level 3.

Process overview: OSSO Agent multi-level authentication flow

1. The user tries to access a resource protected by `mod_osso` on *host1* at level 2.
2. The OSSO Agent sends the request to the OAM Proxy to obtain the authentication scheme details for the protected resource.
3. The OAM_ID cookie for SSO Server and a host based cookie "HOST_port" for *host1* are set and contain authentication level information.
4. After authentication, the user tries to access a resource on *host2* that is protected with a higher level of authentication.
5. The user is redirected to the OAM Server for authentication because this is the first time accessing *host2*.
6. The OAM Server (OSSO Proxy) receives the OAM_ID cookie which has an insufficient level to access the resource on *host2*.
 - If the level is insufficient, the OAM Server (OSSO Proxy) triggers re-authentication.
 - If the level is sufficient, the access is granted access.

22.9.3 Creating an Authentication Scheme

Users with valid Administrator credentials can add a new authentication scheme for use in an Application Domain.

Prerequisites

The authentication module must be defined and ready to use as described in "[Deploying and Managing Individual Plug-ins for Authentication](#)".

See Also:

- "[Authentication Schemes and Pages](#)"
 - [Configuring 11g WebGate and Authentication Policy for DCC](#) if needed
-
-

1. In the Oracle Access Management Console, click **Application Security** at the top of the window.
2. In the Application Security Console, click **Authentication Schemes** in the **Access Manager** section.
3. Click the **Create Authentication Scheme**.

4. Fill in the fresh Authentication Scheme page ([Table 22-20](#)) by supplying information based on your deployment:
 - a. Name: *LDAPSimpleFormScheme*
 - b. Authentication Level
 - c. Challenge Method: FORM
 - d. Challenge Redirect URL: *http://CredentialCollectorhost:port*
 - e. Authentication Module: LDAP
 - f. Challenge URL: */CredentialCollector/loginform...*
 - g. Challenge Parameters: [Table 22-22](#), [Table 22-23](#), [Table 22-30](#)
 - h. Context Type
5. Click **Apply** to submit the new scheme (or close the page without applying changes).
6. Dismiss the Confirmation window.
7. Optional: Click the **Set as Default** button to automatically use this with new Application Domains, then close the Confirmation window.
8. Confirm the new scheme appears in the list of schemes (refresh if needed).
9. Proceed to "[Defining Authentication Policies for Specific Resources](#)".

22.9.4 Searching for an Authentication Scheme

Users with valid Administrator credentials can search for a specific authentication scheme.

See Also:

["SSO Agent Search Page"](#)

1. In the Oracle Access Management Console, click **Application Security** at the top of the window.
2. In the Application Security Console, click **Authentication Schemes** in the **Access Manager** section.
3. In the **Name** field, enter the target scheme name (with or without wild card *). For example:

*OA**
4. Click the **Search** button to initiate the search.
5. Click the Search Results tab to display the results table, and then:
 - **Edit:** Click the **Edit** button in the tool bar to display the configuration page.
 - **Delete:** Click the **Delete** button in the tool bar to remove the instance; confirm removal in the Confirmation window.

- **Detach:** Click **Detach** in the tool bar to expand the table to a full page.
- **View:** Select a **View** menu item to alter the appearance of the results table.

22.9.5 Viewing, Editing, or Deleting an Authentication Scheme

Users with valid Administrator credentials can view or modify an existing authentication scheme.

Note:

During a delete operation, if the Authentication Scheme is associated with any authentication policy, she is prompted with association details. Without policy associations, the scheme is deleted.

See Also:

- ["Authentication Schemes and Pages"](#)
 - ["Configuring the PasswordPolicyValidationScheme "](#)
-
-

1. Search for the target scheme, as described in the previous section.
2. In the list of search results, select the target scheme and click **Edit**.
3. **Edit:**
 - a. On the Authentication Scheme page, modify values for your environment ([Table 22-20](#)).

Note:

In an upgraded deployment with OSSO Agents, change the Authentication Scheme and any Protected Resource Policies to use SSOCOExistMigrateScheme.

 - b. Click **Apply** to submit the changes (or close the page without applying changes).
 - c. Dismiss the Confirmation window.
4. **Set as Default:** Click the **Set as Default** button to automatically use this scheme when creating policies in fresh Application Domains, then close the Confirmation window.
5. **Delete:**
 - a. Review any Application Domain using this authentication scheme and assign a different scheme.
 - b. Review the Authentication Scheme page to confirm this is the scheme to remove, then close the page.

- c. In the navigation tree, click the name of the scheme and then click the **Delete** button in the tool bar.
- d. Confirm removal (or dismiss the Confirmation window).

22.10 Extending Authentication Schemes with Advanced Rules

Advanced Rules have been added to allow for extending an existing authentication policy.

Both Pre-Authentication and Post-Authentication rules can be applied although the following configurations are not supported by Post-Authentication Rules.

- Two or more resources front ended by the same OHS/WebGate and protected by the same Authentication Scheme.
- A Post-Authentication rule configured for one of the resources defined in step up authentication.
- A user accesses a resource for which no Post-Authentication rule is configured followed by a resource for which a Post-Authentication rule is configured for step up authentication. In this case, the Post-Authentication rule configured for the resource is not effective.

Note:

Advanced Rules are part of the Adaptive Authentication Service for which a license is required. See [About Adaptive Authentication Service](#).

Advanced Rules contain Boolean expressions. If there is more than one triggered outcome to an Authentication Scheme, the lowest execution order outcome will be chosen as the final outcome. [Table 22-24](#) documents the attributes that need be defined when creating an Advanced Rule.

Table 22-24 *Advanced Rules Attributes*

Name	Description
Name	AuthnRule name. Name has to be unique within the checkpoint
Description	Description of the rule
Execution Order	Order in which the outcome will be executed in cases of more than 1 outcome
Condition	Script; the user can configure condition based on the HTTP request header's availability and set the desired outcome
Outcome	ID of the Authentication Scheme to which the rule applies. Access / Deny.

Note: If the **Deny Access** option is selected, an error message, The requested URL was not found, is displayed.

See the following sections for details.

- [Advanced Rules Use Cases](#)
- [Context Data for Advanced Rules](#)

22.10.1 Advanced Rules Use Cases

You can configure advance rules for certain scenarios.

For the following use cases, configure Advanced Rules:

- **Non Browser Client** - For user authentication, a form-based login page is presented through the browser for the user to complete. In some cases, a non-browser client (switches, routers and the like) might need to do basic authentication based on credentials passed via the request header. Non-browser client authentication can be configured as a pre-authentication Advanced Rule only. To support non-browser client authentication, configure the desired condition in an Authentication Rule (based on the HTTP request header's availability) and set the desired outcome.
- **Windows Native Authentication Option** - An Advanced Rule can be configured to allow for switching between Windows Native Authentication (WNA) and form-based user authentication depending on whether the user comes thru VPN or a corporate network.
- **User Authentication Scheme Option** - An Advanced Rule can be configured to allow the user to choose the method of authentication. The choice would be passed as a request parameter.
- **Second Factor Authentication** - An Advanced Rule can be configured to allow for Second Factor Authentication (SFA) based on defined user or request attributes. For details on SFA, see [Introducing the Adaptive Authentication Service](#) .

[Table 22-25](#) contains examples of how the conditions might be configured in these Advanced Rules use cases.

Table 22-25 Sample Advanced Rules

Sample Rule	Sample Jython Script-based Condition	Notes
Switching authentication scheme based on private or public IP rule	location.clientIP.startswith('10.') <i>or</i> location.clientIP.startswith('172.16') <i>or</i> location.clientIP.startswith('192.168')	This rule can be used in Pre and Post authentication checkpoints
Black listed IP	location.clientIP in ['130.35.50.115', '130.35.50.112', '130.35.50.113']	This rule can be used in Pre and Post authentication checkpoints
Client Browser Type	request.userAgent.lower().find('firefox') > 0	This rule can be used in Pre and Post authentication checkpoints
Blocking access to user having user attribute 'description' equals 'test'	user.userMap['description'] == 'test'	This rule can be used only in Post authentication checkpoints

Table 22-25 (Cont.) Sample Advanced Rules

Sample Rule	Sample Jython Script-based Condition	Notes
Non browser client	<code>request.authorization.lower().startswith('basic')</code>	This rule can be used only in Pre authentication checkpoints
Customer HTTP Header value	<code>request.requestMap['param'] == 'test'</code>	This rule can be used in Pre and Post authentication checkpoints
Switching authentication scheme based on IP address in range	<code>location.isIPinRange('192.35.50.180','192.35.50.188')</code>	This rule can be used in Pre and Post authentication checkpoints

22.10.2 Context Data for Advanced Rules

Before executing the Authentication Condition, the Access Manager server prepares a request context using the available data (to construct a Boolean expression based condition).

The following tables describe the various context data details.

- [Table 22-26](#)
- [Table 22-27](#)
- [Table 22-28](#)
- [Table 22-29](#)

Table 22-26 Request Context Data

Attribute Name	Description
requestMap	Map of all the request headers, parameters and post data values. This example can get the custom-header key from request header and compare it with value 'test'. <code>request.requestMap['custom-header'].lower().find('test') > 0</code>
resourceMap	Map of matched resource details
accept	Returns 'Accept' header value
acceptCharset	Returns 'Accept-Charset' header value
acceptEncoding	Returns 'Accept-Encoding' header value
acceptLanguage	Returns 'Accept-Language' header value
authorization	Returns 'Authorization' header value
connection	Returns 'Connection' header value

Table 22-26 (Cont.) Request Context Data

Attribute Name	Description
contentLength	Returns 'ContentLength' header value
cookie	Returns 'Cookie' header value
host	Returns 'Host' header value
ifModifiedSince	Returns 'ifModifiedSince' header value
pragma	Returns 'Pragma' header value
referer	Returns 'Referer' header value
userAgent	Returns 'UserAgent' header value
resourceHost	Returns matched Resource's Host value
resourcePost	Returns matched Resource's Port value
resourceOperation	Returns matched Resource's Operation value
resourceQueryString	Returns matched Resource's QueryString
resourceName	Returns matched Resource's name
resourceType	Returns matched Resource's Type
resourceURL	Returns matched Resource's URL; for example, if 'landingPage' is in request.resourceURL, condition will evaluate to true if resourceURL has landingPage in it.
isIPinRange('start IP' ,end IP')	Evaluates to true if location.clientIP is in the specified range. Example: <code>location.isIPinRange('192.35.50.180', '192.35.50.188')</code>

Table 22-27 Location Context Data

Attribute Name	Description
locationMap	Map of all the location data values; for example: <code>location.locationMap['CLIENT_IP'] == '10.1.23.4'</code>
clientIP	Returns client IP address; for example: <code>location.clientIP.startswith('10.2')</code>
proxyIP	Returns Proxy IP address

Table 22-28 Session Context Data

Attribute Name	Description
sessionMap	Map of all the session data values; for example: <code>session.sessionMap['count'] > 2;</code>

Table 22-28 (Cont.) Session Context Data

Attribute Name	Description
count	Returns number of sessions for the current user; for example: <code>session.count > 2</code>

Table 22-29 User Context Data

Attribute Name	Description
userMap	Map of all the user profile data; for example: <code>user.userMap['email'] == 'john.joe@example.com'</code>

22.11 Configuring Challenge Parameters for Encrypted Cookies

OAM provides challenge parameters that you can use within any authentication scheme to control flags of the encrypted cookies.

- [Challenge Parameters for Encrypted Cookies](#)
- [Configuring Challenge Parameters for Security of Encrypted Cookies](#)
- [Setting Challenge Parameters for Persistence of Encrypted Cookies](#)

22.11.1 Challenge Parameters for Encrypted Cookies

In addition to the OAM Server cookie (OAM_ID), Access Manager implements single sign-on through an encrypted cookie

- **11g Webgate, One per agent:** OAMAuthnCookie_<host:port>_<random number> set by Webgate using the authentication token received from the OAM Server after successful authentication

Note: A valid OAMAuthnCookie is required for a session.

- **10g Webgate,** One ObSSOCookie for all 10g Webgates.

Access Manager provides the `ssoCookie` challenge parameter that you can use within any authentication scheme to control how Webgates set the flags of the encrypted cookie. For example:

- **Securing Encrypted Cookie:** Ensures that the encrypted cookie is sent only over an SSL connection and prevents the encrypted cookie from being sent back to a non-secure Web server.
- **Persisting Encrypted Cookie:** Allows the user to log in for a time period rather than a single session. Persistent cookie functionality works with Internet Explorer and Mozilla browsers.

Note:

The value of the challenge parameter is not case sensitive. Syntax is the same regardless of your Webgate release. A single value is specified after the equal sign (=):

```
ssoCookie=value
```

Multiple values must be separated by a semicolon (;). For example:

```
ssoCookie=value1;value2;...
```

- For detached credential collector-enabled Webgates, set these parameters directly in the agent registration page ([Table 15-2](#)).
- For non-DCC agents (Resource Webgates), these parameters are configured through Authentication Scheme challenge parameters ([Table 22-30](#)).

[Table 22-30](#) describes specific challenge parameters that control how Webgates set encrypted cookie flags for single sign-on.

Table 22-30 Challenge Parameters for 10g/11g Encrypted Cookies

11g /10g Webgate Challenge Parameter Syntax for Encrypted Cookies	Description
ssoCookie=	Parameter that controls flags for the SSO cookie OAMAuthnCookie.
miscCookies=	Parameter that controls flags for all other Access Manager encrypted cookies.
Secure	Ensures that the encrypted cookie is sent only when the resource is accessed through HTTPS. A secure cookie is required only when a browser is visiting a server using HTTPS. ssoCookie=Secure miscCookies=Secure
disableSecure	Explicitly disables Secure cookies. ssoCookie=disableSecure miscCookies=disableSecure
httponly	Enabled by default with 11g Webgate SSO OAMAuthnCookie and miscellaneous cookies. ssoCookie=httponly miscCookies=httponly

Table 22-30 (Cont.) Challenge Parameters for 10g/11g Encrypted Cookies

11g /10g Webgate Challenge Parameter Syntax for Encrypted Cookies	Description
<code>disablehttponly</code>	Explicitly disables <code>httponly</code> functionality, making the encrypted cookies accessible to client-side scripts. <code>ssoCookie=disablehttponly</code> <code>miscCookies=disablehttponly</code>
<code>ssoCookie=max-age=time-in-seconds</code>	Creates a persistent cookie in browsers, rather than one that lasts for a single session, and specifies the time interval <i>in-seconds</i> when the cookie expires. For example, to set the cookie to expire in 30 days (2592000 seconds): <code>max-age=2592000</code>

22.11.2 Configuring Challenge Parameters for Security of Encrypted Cookies

The challenge parameter is not case sensitive.

See Also:

["Creating an Authentication Scheme"](#)

1. Create an authentication scheme.
2. In the Challenge Parameter field, enter your specification for the desired encrypted cookies ([Table 22-30](#)).
3. Confirm that the OAM Servers and clients (OAM Agents) are communicating securely across the Oracle Access Protocol channel, as described in [Securing Communication](#).

22.11.3 Setting Challenge Parameters for Persistence of Encrypted Cookies

The challenge parameter is not case sensitive.

See Also:

["Creating an Authentication Scheme"](#)

1. Define an authentication scheme.
2. In the challenge parameter for this scheme, add the following ([Table 22-30](#)):

WebGate `ssoCookie=max-age=time-in-seconds`

22.12 Configuring Authentication POST Data Handling

Post data preservation and restoration functions apply to both credential collectors (ECC or DCC).

This section provides the following topics:

- [Authentication POST Data Preservation and Restoration](#)
- [Authentication POST Data Handling](#)
- [Configuring Authentication POST Data Handling](#)
- [Testing POST Data Handling Configuration](#)

22.12.1 Authentication POST Data Preservation and Restoration

POST data preservation and restoration functions come into play when an application has a form wherein the user has entered a credential (or other data) but the session has expired, an idle session timeout has occurred, or the token validity period has ended by the time the user submits the form. If this scenario occurs, the user is presented with a fresh login form (depending on the authentication scheme) unless POST data is preserved and restored.

Administrators can configure the Resource Webgate to perform POST data preservation when the expired user and newly authenticated user are the same.

[Table 22-31](#) describes Resource Webgate support and behavior for post data.

Note:

Authentication POST data preservation and restoration is not supported when Access Manager performs authentication through custom agents.

Table 22-31 Resource Webgate Support of POST Data Preservation and Restoration

Resource Webgate	Description
Supports Authentication Schemes	LDAP, Basic, Sessionless Basic, X509, WNA
Supports form encoding	with text/html, text/plain, multipart/form-data, and application/x-www-form-urlencoded type data posted by the application form.
Preserves	The encoding type of the data posted by the original application form, except the input field of file type.
Ensures	The downstream application sees the same post data that was posted by the original application form.
Constrains	The overall size of the inbound request data or the inbound front channel message. There shall be a configuration parameter to override the code default value. This shall be per application.

Table 22-31 (Cont.) Resource Webgate Support of POST Data Preservation and Restoration

Resource Webgate	Description
Maintains application data confidentiality and integrity	Neither the Resource Webgate nor credential collector will interpret, nor log, application post data. If, after expiration and during re-authentication, the user authenticates with different credentials, then the post data of the previous user is cleared by the Resource Webgate and not restored. However, Webgate will post to the downstream application URL that was posted by the original application form.
Ignores Preservation if ... Logs a Message when ... Performs Standard Authentication if ... Shows an Error when ...	Post data is larger than the configured or hard-coded limit, preservation is ignored. Post data is skipped because it is bigger than the allowed limit, a message is logged. Post data size is larger than the hard-coded limit (or the configured value), the standard authentication flow is used. Together, if both front channel message data and application post data are large an error occurs.

Credential Collector Support for POST Data Handling

- ECC and DCC
- Compatible with earlier 11g Webgates
- Supports post data preservation for Form based authentication scheme with the default login form provided out of the box.
- Preserves application post data during authentication processing by:
 - Challenging the user
 - Re-challenging the user if invalid credentials are provided
- Does not interpret application post data.
- Constrains the overall size of inbound front-channel messages using a configuration parameter to override the default value, per application.
- Logs a warning when post data is skipped because it is larger than the allowed limit.
- Does not preserve application post data when:
 - Authentication policy is configured with Success or Failure authentication URLs
 - Password management (password expiration and so on) is involved
 - Access Manager is used for performing authentication through custom agents.
- ECC Only

- The embedded credential collector does not support POST data handling with the external login page.
- DCC Only
 - POST data is preserved through the HTTP header, and the amount of POST data that can be handled to 8192 characters.
 - POST data restoration with a Form-based Authentication Scheme requires the challenge parameter **TempStateMode=form**.
 - DCC does not support custom login pages.
 - DCC does not support POST data restoration during password management operations (password expiration, for instance) when the URL_ACTION in the password policy plug-in is set to anything other than FORWARD.

22.12.2 Authentication POST Data Handling

Authentication Schemes such as WNA, Basic and X509 are supporting POST Data Handling.

The following are the Authentication Schemes Supporting POST Data Handling:

- FORM challenge method, supported with the out of the box login page.
- WNA
- Basic
- Basic+Sessionless
- X509
- OIF, OIM, OAAM integrations using TAP

[Table 22-32](#) summarizes complete configuration requirements for authentication POST data handling. All requirements described in [Table 22-32](#) are supported end to end with the specified authentication schemes.

Table 22-32 Parameters Required for Authentication POST Data Handling

Parameter	Description
MaxPostDataBytes	<p>Configure this Authentication Scheme challenge parameter for POST-data preservation used by the DCC only to limit the maximum size of the POST data that can be posted as on the login form. DCC compares the value of the content-length header with the limit set.</p> <p>Default: unlimited</p> <p>This Authentication Scheme challenge parameter requires a positive integer value that restricts the maximum number of bytes of POST data that is submitted as user credentials and sent to the OAM Server.</p>

Table 22-32 (Cont.) Parameters Required for Authentication POST Data Handling

Parameter	Description
MaxPreservedPostDataBytes	<p>Configure this Authentication Scheme challenge parameter (or user-defined Webgate parameter) for authentication POST-data preservation.</p> <p>Default: 8192 bytes</p> <p>Note: Preference is given first to the Authentication Scheme containing this parameter; second to the Webgate providing this user-defined parameter. Otherwise, default behavior is 8192 bytes.</p> <p>This parameter defines the maximum length of POST data that Webgate can preserve. If the size of inbound raw user POST data (or encrypted post data after processing), crosses this limit, POST data is dropped and the existing authentication flow continues. The event is logged as usual.</p> <p>See Also: "Configuring Authentication POST Data Handling" Table 15-2</p>
TempStateMode=form <i>DCC Only</i>	<p>With the DCC, a Form-based Authentication Scheme requires the challenge parameter TempStateMode=form for POST data restoration. For Form authentication scheme, if this parameter is not defined, the value will be "form".</p> <p>See Also: "Configuring Authentication POST Data Handling" Table 15-2</p>
ChallengeRedirectMaxMessageBytes	<p>Configure this user-defined Webgate parameter to limit the size of the message data received as obrareq.cgi and obrar.cgi. Message data is comprised of query string length (if present) or POST data length (if POST data is present). If message size exceeds this limit, the message is not processed and the existing message is shown in the browser. The event is logged as usual.</p> <p>Default: 8192 bytes</p> <p>Notes:</p> <p>obrareq.cgi is the authentication request in the form of a query string redirected from Webgate to the credential collector (OAM Server or DCC).</p> <p>obrar.cgi is the authentication response string redirected from the credential collector (OAM Server or DCC) to Webgate.</p> <p>See Also: "Configuring Authentication POST Data Handling" Table 15-2</p>
PostDataRestoration	<p>Configure this user-defined Webgate parameter to initiate authentication POST-data preservation for the resource Webgate. This parameter requires a value of <code>true</code> or <code>false</code>.</p> <p>Default: <code>false</code></p> <p>When set to <code>true</code>, Webgate initiates POST data preservation.</p> <p>See Also: "Configuring Authentication POST Data Handling" Table 15-2</p>

Table 22-32 (Cont.) Parameters Required for Authentication POST Data Handling

Parameter	Description
serverRequestCacheType <i>ECC Only</i>	<p>Configure this OAM parameter to define the mechanism used to remember the request context by the embedded credential collector (ECC).</p> <p>This OAM Server parameter in <code>\$DOMAIN_HOME/config/fmwconfig/oam-config.xml</code> indicates mechanism to be used to remember the request context. Possible values are FORM, COOKIE, or CACHE.</p> <p>Default: COOKIE</p> <p>FORM is the required value for POST data preservation, Long URL handling and Form-based authentication schemes.</p> <p>See Also: TempStateMode in this table. "Configuring Authentication POST Data Handling"</p>

22.12.3 Post Data Size Limits

Assuming the usual form data entered by users is about several kilobytes, putting a limit on data consumption from the incoming request is a general requirement. The data transferred in the front channel protocol (either request or response) must also go through the size check.

Considering these situations:

- Limit the size of data passed to the OAM Server on the back channel using the `maxpostdatabytes` authentication challenge parameter
 In cases where the DCC is used, the `maxpostdatabytes` authentication challenge parameter performs this check on the overall POST data.
- Limit the size of the POST data from the end user application using `MaxPreservedPostDataBytes` authentication scheme challenge parameter.
 The `MaxPreservedPostDataBytes` authentication scheme challenge parameter handles this. Additionally, this can be set as a user-defined Webgate parameter.
- Limit size of the front channel payload on `obrar.cgi` or `obrareq.cgi` with a Webgate user-defined parameter `ChallengeRedirectMaxMessageBytes`.

22.12.4 Configuring Authentication POST Data Handling

Be sure to read all POST data topics in this section before attempting this procedure. There is no need to make any explicit change in your authentication scheme.

1. Configure the Authentication Scheme:

- Use the Oracle Access Management Console to create or find the desired scheme ([Authentication POST Data Handling](#)).
- On the Authentication Scheme page, modify values for POST data handling.

This example uses the embedded credential collector ([Table 22-20](#)) and values for POST data handling ([Table 22-23](#)):

Name: *DesiredScheme*
 Authentication Level 2

Challenge Method: **Form**
 Challenge Redirect URL: /oam/server/
 Authentication Module: **LDAP**
 Challenge URL: /pages/login.jsp
 Context Type: **External**
 Challenge Parameters

Authentication Scheme Challenge Parameters for Post Data with ECC	Authentication Scheme Challenge Parameters for Post Data with DCC
MaxPreservedPostDataBytes=9000	MaxPreservedPostDataBytes=9000 TempStateMode=form

- c. Click **Apply** to submit the changes.
2. ECC: Configure serverRequestCacheType, the OAM parameter in oam-config.xml, if using ECC.
 - a. Stop the managed server.
 - b. Stop the administration server.
 - c. Open oam-config.xml and modify the value of serverRequestCacheType.
 - d. Save the file.
 - e. Restart the administration server.
 - f. Restart the managed server.
3. Configure Webgate Parameters for POST data handling:
 - a. From the System Configuration tab, Access Manager section, create or find the desired OAM Agent registration.
 - b. On the agent registration page, submit values for POST data handling (Table 22-23):

Name: *DesiredAgent*
 User-Defined Parameters

User-Defined Webgate Post Data Parameters with ECC	User-Defined Webgate Post Data Parameters with DCC
PostDataRestoration=true	PostDataRestoration=true

- c. Click **Apply** to submit the changes.

22.12.5 Testing POST Data Handling Configuration

The following actions can be performed in sequence to test your POST data handling configuration.

1. Complete all configurations as documented.

2. Develop a simple script to print the POST data and the URL protected by Webgate.
3. Use a browser to access the protected resource.
4. Provide credentials and establish SSO. Wait for the idle session timeout period.
5. With the same browser, use the form to post data to the same Webgate using the URL which can print the POST data. You will be redirected to credential collector.
6. Enter the same credentials previously used.

From the HTTP headers you can see, after getting obrar.cgi from the credential collector, the protected resource Webgate will give a 200 response (previously it was 302) and the POST data can be printed by your script.

22.13 Long URL Handling During Authentication

Long URL handling applies to both credential collectors (ECC or DCC) and is a default operation.

22.13.1 About Long URLs and Authentication Handling

Authentication involves redirecting the user's request to a centralized component that performs authentication, known as a Credential Collector. The mechanism used to redirect user from the policy enforcement point (OAM Agent) to the Credential Collector, is a proprietary front channel protocol over HTTP. This protocol currently provides the context of the request and the authentication response on the query string. In situations where the URL of the requested page is larger, the overall context becomes larger and can go beyond the browser's permissible size. This is referred to as Long URL Handling.

By default, the Resource Webgate checks the payload size of the front channel protocol message to determine if it is larger than the coded limit. When long URL handling is explicitly enabled, the limit is ignored and has no impact.

The credential collector determines if the front channel response payload is to be sent as HTTP Post data when:

- The incoming request indicates that the agent is capable of handling HTTP POST or REDIRECT type of response
- The credential collector is configured to always send the payload as HTTP post data
- The credential collector is configured to always send the payload as a query string

If no explicit configuration is present, then if the payload size is greater than predefined limit, then it shall send payload as the HTTP post data. But if the payload size is lower than the predefined limit, then it shall send it on the query string.

Note:

If application post data is also preserved there is no impact.

[Table 22-33](#) identifies Long URL handling functionality with both the ECC and DCC.

Table 22-33 ECC and DCC: Long URL Handling

ECC Long URL Handling	DCC Long URL Handling
ECC is compatible with all 11g Webgates.	Same as ECC.
N/A	<p>Long URL handling is limited to the maximum allowed size of the DCCContextCookie.</p> <p>The DCC does not perform explicit long URL handling.</p> <p>There is no support to preserve the front channel payload on the form.</p>

22.13.2 Configuration Requirements for Long URL Handling

The following are the Authentication Schemes Supporting Long URL Handling:

- FORM challenge method, supported with the out of the box login page.
- WNA
- Basic
- Basic+Sessionless
- X509
- OIF, OIM, OAAM integrations using TAP

[Table 22-34](#) summarizes the parameters and complete configuration requirements for authentication Long URL handling. All requirements described in [Table 22-34](#) are supported end to end with the specified authentication schemes.

Table 22-34 Parameters Required for Long URL Handling

Parameter	Description
ChallengeRedirectMethod	<p>Configure this as either as an Authentication Scheme challenge parameter (or as a user-defined Webgate parameter) for POST-data preservation for both the embedded credential collector (ECC) and the detached credential collector (DCC).</p> <p>Note: Preference is given first to the Authentication Scheme containing this parameter; second to the Webgate providing this user-defined parameter. Otherwise, default behavior is Dynamic.</p> <p>Value: GET POST DYNAMIC</p> <p>Behavior when value is:</p> <ul style="list-style-type: none"> • POST: Webgate sends encquery as POST data and credential collectors send encreply as POST data. • GET: Webgate sends encquery as query string and expects encreply as query string. • DYNAMIC: Default behavior, based on the length of the encquery/encreply. Webgate/credential collector sends data either as a query string or as POST data. Code default maximum length is 2000 characters. <p>See Also: "Configuring Authentication POST Data Handling" Table 15-2</p>
ChallengeRedirectMaxMessageBytes	<p>Configure this user-defined Webgate parameter to limit the size of the message data received as obrareq.cgi and obrar.cgi. Message data is comprised of query string length (if present) or POST data length (if POST data is present). If message size exceeds this limit, the message is not processed and the existing message is shown in the browser. The event is logged as usual.</p> <p>Default: 8192 bytes</p> <p>Notes:</p> <p>obrareq.cgi is the authentication request in the form of a query string redirected from Webgate to the credential collector (OAM server or DCC).</p> <p>obrar.cgi is the authentication response string redirected from the credential collector (OAM server or DCC) to Webgate.</p> <p>See Also: "Configuring Authentication POST Data Handling" Table 15-2</p>
serverRequestCacheType <i>ECC Only</i>	<p>Configure this OAM parameter to define the mechanism used to remember the request context by the embedded credential collector (ECC).</p> <p>This OAM Server parameter in <code>\$DOMAIN_HOME/config/fmwconfig/oam-config.xml</code> indicates mechanism to be used to remember the request context. Possible values are FORM, COOKIE, or CACHE.</p> <p>Default: COOKIE</p> <p>FORM is the required value for POST data preservation, Long URL handling and Form-based authentication schemes.</p> <p>See Also: TempStateMode in this table. "Configuring Authentication POST Data Handling"</p>

Long URL handling is enabled by default. The Webgate/credential collector sends data either as a query string or a POST. The length of the querystring parameter sent with obrareq.cgi and obrar.cgi is 2000 characters maximum.

22.14 Using Application Initiated Authentication

Access Manager exposes a Reauthentication URL that applications may choose to invoke if the user is accessing a sensitive URL or operation. This re-authentication will be triggered irrespective of whether or not the user already has a valid session.

An application can trigger re-authentication by invoking the /oamreauthenticate URL at:

```
http://<ohs_host>:<ohs_port>/oamreauthenticate
```

Access Manager will expect the /oamreauthenticate to be registered and associated with an authentication policy. Re-authentication will be performed using the scheme associated with this policy. The re-authentication URL takes the redirection URL as a query parameter. After re-authentication is complete, Access Manager redirects the user to this URL. A request to re-authenticate the user might look like the following:

```
http://<host>:<port>/oamreauthenticate?  
  redirect_url=http://<host>:<port>/<redirection_resource_url>
```

If the redirection URL is not specified, a 404 error code is returned. If the incorrect credentials are specified during re-authentication, the user will remain on the login page and, after the maximum retry limit, the user will be redirected to an appropriate error page. The following process is how to configure for application initiated authentication.

1. Create an `http://<ohs_host>:<ohs_port>/oamreauthenticate` resource and assign the desired authentication scheme to it.
2. In the redirect URL, set the appropriate responses to verify that re-authentication has been successful and to communicate back to the application about the re-authentication responses.

Access Manager sets the last re-authentication time as a "OAM_LAST_REAUTHENTICATION_TIME" header and this value is updated every time the user is re-authenticated.

Understanding Credential Collection and Login

Access Manager credential collection is a functionality that can be executed either on the Access Manager server (ECC) or WebGates (DCC).

This chapter includes the following topics:

- [Overview of Access Manager Credential Collection](#)
- [Overview of the SSO Login Process with OAM Agents and ECC](#)
- [Overview of the SSO Login Process with OAM Agents and DCC](#)
- [Overview of the SSO Login Process with OSSO Agents \(mod_osso\) and ECC](#)
- [Configuring 11g WebGate and Authentication Policy for DCC](#)
- [Tunneling from DCC to Access Manager Over Oracle Access Protocol](#)
- [Configuring a DCC WebGate for X509 Authentication](#)

Note:

Unless explicitly stated, information in this chapter is the same for all agent types and Access Manager credential collectors.

See [Introduction to Centralized Logout for Access Manager 11g](#).

23.1 Overview of Access Manager Credential Collection

Access Manager provides two mechanisms for credential collection during authentication processing.

- The default Embedded Credential Collector (ECC) is installed with the Access Manager Server and can be used as-is with no additional installation or set up steps (except the global password policy configuration described in "[Managing Global Password Policy](#)").

The mechanism that redirects the user from the Policy Enforcement Point to the Credential Collector is a proprietary front channel protocol over HTTP. This protocol currently provides a context of the request and the authentication response on the query string.

- The 11.1.2 (or later) WebGate provides a single switch for the optional Detached Credential Collector (DCC). The DCC provides network isolation for greater security in production deployments, and is required for some forms of authentication.

For a detailed comparison of the two mechanisms for credential collection, see [Understanding Authentication Methods and Credential Collectors](#).

Note:

Although the DCC is the recommended approach for credential collection, instructions in this book presume you are using the ECC unless explicitly stated.

Single Sign On login processing determines whether the user is a valid user and whether the session state is active or inactive (either a first time user or the user session has expired). Session management support locates, persists, and cleans up the session context and user token. Details are in the following sections.

- [Overview of the Login process with Self-Service Provisioning Applications](#)
- [Overview of the Login Process with Access Manager-Protected Resources](#)

23.1.1 Overview of the Login process with Self-Service Provisioning Applications

Provisioning does not create the session in Access Manager. When a new user uses a self-service provisioning application to create an account, he is prompted for his userID and password again when accessing an application.

The protected application is directed to Access Manager 11g, which requests the user's credentials. For example, if Oracle Identity Manager is protected by Access Manager, the user request is redirected to Access Manager from which a request to enter credentials is made.

Note:

Success and failure results are the same as described in "[Overview of the Login Process with Access Manager-Protected Resources](#)".

23.1.2 Overview of the Login Process with Access Manager-Protected Resources

The first time a user attempts to access a protected resource, she is prompted for her credentials based on the authentication scheme and authentication level for the resource. Typically a userID and password are needed.

Failure: Authentication fails if the wrong userID or password is entered. The user is not authenticated and another prompt for credentials appears.

With Oracle Access Manager 11.1.1, only the ECC in the OAM server was available. Access Manager 11.1.2 supports the ECC by default. However, Access Manager also enables you to configure an 11g WebGate to use as a detached credential collector (DCC). A DCC-enabled WebGate can be separate from (or combined with) a Resource WebGates.

Both the ECC and DCC provide an authentication flow that includes form login, error, and login retries. They provide SecurID and server affinity as well as password policy enforcement and a dynamic, multi-step, iterative, and variable (multi-step authentication) where the credentials are not supplied all at one time. A customizable authentication flow can include authentication plug-ins with contracts between the

plug-in, OAM Proxy, and Credential Collector; a contract between the plug-in and login application; and between the Credential Collector and login application.

When deciding whether to use one credential collector or both, consider:

- **Co-existence:** Allowing both the ECC and DCC to co-exist enables you to use authentication schemes and policies configured for either the ECC or the DCC. This enables a fallback mechanism for resources that rely on the ECC (Oracle Access Management Console, for instance).
- **Disabling ECC:** Disabling the ECC entirely prohibits access to resources that rely on the ECC mechanism (Oracle Access Management Console, for instance).

Table 23-1 provides links to more information.

Table 23-1 Login Processing with Access Manager-Protected Resources

Login Processing Topic	See
With OAM Agents and ECC	"Overview of the SSO Login Process with OAM Agents and ECC "
With OAM Agents and DCC	"Overview of the SSO Login Process with OAM Agents and DCC "
With OSSO Agents and ECC	"Overview of the SSO Login Process with OSSO Agents (mod_osso) and ECC"
With Other Agents or Mixed Agent Types	Mixed agent types are supported. Processing is the same for each agent type. For other agent types, see: <ul style="list-style-type: none"> • Registering and Managing Legacy OpenSSO Agents • Registering and Managing Legacy OSSO Agents • Registering and Managing 10g WebGates with Access Manager 11g
Login and Auto Login for Applications Using Oracle ADF Security	Oracle Platform Security Services (OPSS) comprise Oracle WebLogic Server's internal security framework. On the Oracle WebLogic Server, you can run a Web application that uses Oracles Application Development Framework (Oracle ADF) security, integrates with Access Manager 11g SSO, and uses OPSS SSO for user authentication. For more information, see Integrating Oracle ADF Applications with Access Manager SSO .

23.2 Overview of the SSO Login Process with OAM Agents and ECC

Access Manager authenticates each user with a customer-specified authentication method to determine the identity and leverages information stored in the user identity store.

This topic is based on using the default Embedded Credential Collector with OAM Agents (Resource WebGates) protecting resources.

Access Manager authentication supports several authentication methods and a number of authentication levels. Resources with varying degrees of sensitivity can be protected by requiring higher levels of authentication that correspond to more stringent authentication methods.

When a user tries to access a protected application, the request is received by Access Manager which checks for the existence of the SSO cookie.

After authenticating the user and setting up the user context and token, Access Manager sets the SSO cookie and encrypts the cookie with the SSO Server key (which can be decrypted only by the SSO Engine).

Depending on the actions (responses in Access Manager 11g) specified for authentication success and authentication failure, the user may be redirected to a specific URL, or user information might be passed on to other applications through a header variable or a cookie value.

Based on the authorization policy and results of the check, the user is allowed or denied access to the requested content. If the user is denied access, she is redirected to another URL (specified by the Administrator in WebGate registration).

Figure 23-1 shows the processes involved in evaluating policies, validating a user's identity, authorizing the user for a protected resource, and serving the protected resource. This example shows the OAM Agent flow. There are slight variations with 11g WebGates/Access Clients.

Figure 23-1 SSO Log-in with Embedded Credential Collector and OAM Agents

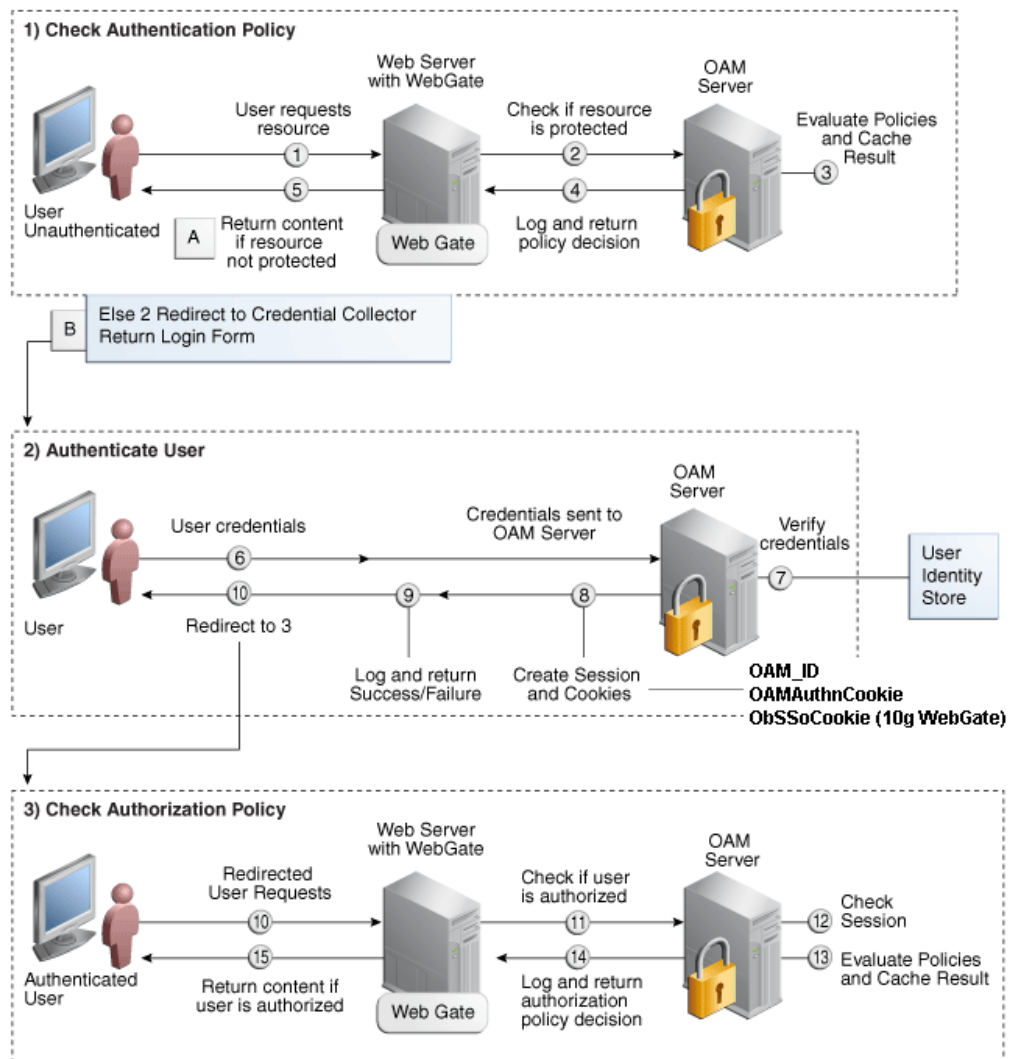

Process overview: SSO Login Processing with Embedded Credential Collector and OAM Agents

1. The user requests a resource.
2. WebGate forwards the request to Access Manager for policy evaluation.
3. Access Manager:
 - Checks for the existence of an SSO cookie.
 - Checks policies to determine if the resource protected and if so, how?
4. Access Manager Server logs and returns decisions.
5. WebGate responds as follows:
 - a. **Unprotected Resource:** Resource is served to the user.
 - b. **Protected Resource:**
 - Request is redirected to the credential collector.
 - The login form is served based on the authentication policy.
 - Authentication processing begins
6. User sends credentials.
7. Access Manager verifies credentials.
8. Access Manager starts the session and creates the following host-based cookies:
 - **One per Agent:** OAMAuthnCookie set by 11g WebGates (ObSSOCookie set by 10g Webgate) using the authentication token received from the OAM Server after successful authentication.
 - Note:** A valid cookie is required for a session.
 - **One for OAM Server:** OAM_ID
9. Access Manager logs Success or Failure.
10. Credential collector redirects to WebGate and authorization processing begins.
11. Webgate prompts Access Manager to look up policies, compare the user's identity, and determine the user's level of authorization.
12. Access Manager logs policy decision and checks the session cookie.
13. OAM Server evaluates authorization policies and cache the result.
14. OAM Server logs and returns decisions
15. WebGate responds as follows:
 - If the authorization policy allows access, the desired content or applications are served to the user.
 - If the authorization policy denies access, the user is redirected to another URL determined by the Administrator.

23.3 Overview of the SSO Login Process with OAM Agents and DCC

The detached credential collector is simply a WebGate configured to use the additional Credential Collection capability in your deployment.

There are two deployment types depending on whether the DCC WebGate is also protecting the applications or not.

[Table 23-2](#) identifies the DCC-supported deployments.

Table 23-2 DCC Deployment Support

Deployment Type	Description
Separate DCC and Resource Webgate	<p>A distributed deployment where WebGates protecting applications are managed independently from the centralized DCC. You can have:</p> <ul style="list-style-type: none"> Two or more 11.1.1.5 Resource Webgates that redirect to the 11.1.2 DCC-enabled WebGate for authentication 10.1.4.3 Resource WebGate that redirects to the 11.1.2 DCC-enabled WebGate for authentication <p>Enable HTTPS between the user-agent and the DCC (but not with some or all Resource WebGates).</p> <p>When credential collection is externalized and centralized in the DCC, the user-agent connections with other WebGates never carry user credentials, nor session tokens that could be used to obtain access to resources protected by any other WebGate. This significantly reduces exposure caused by lack of SSL on these links and may be an acceptable tradeoff in some deployments.</p> <ul style="list-style-type: none"> Separate OHS Instances: Install the DCC on a different OHS instance (on the same or different host) as the Resource WebGate. Define the Resource WebGate Authentication Scheme Challenge Redirect URL to point to the DCC. Define the Resource WebGate logoutRedirectUrl to point to the DCC logout script/page (logout callbacks to Resource WebGate is invoked during logout). <p>See Also: Figure 23-2</p>
Combined DCC and Resource Webgate	<p>A streamlined deployment minimizing configuration and processing overhead.</p> <p>A DCC WebGate can function as both a resource WebGate (Policy Enforcement Point) that protects application resources and a DCC. In this case, there is no front-channel redirection or processing:</p> <ul style="list-style-type: none"> Install the DCC on a the same OHS instance (on the same host) as the Resource WebGate. Simplified configuration: The Challenge Redirect URL can be empty. No logoutRedirectUrl is needed, no logout callback is needed. <p>See Also: Figure 23-3</p>

Separate DCC and Resource Webgates: A sample deployment with segregated DCC is shown in [Figure 23-2](#).

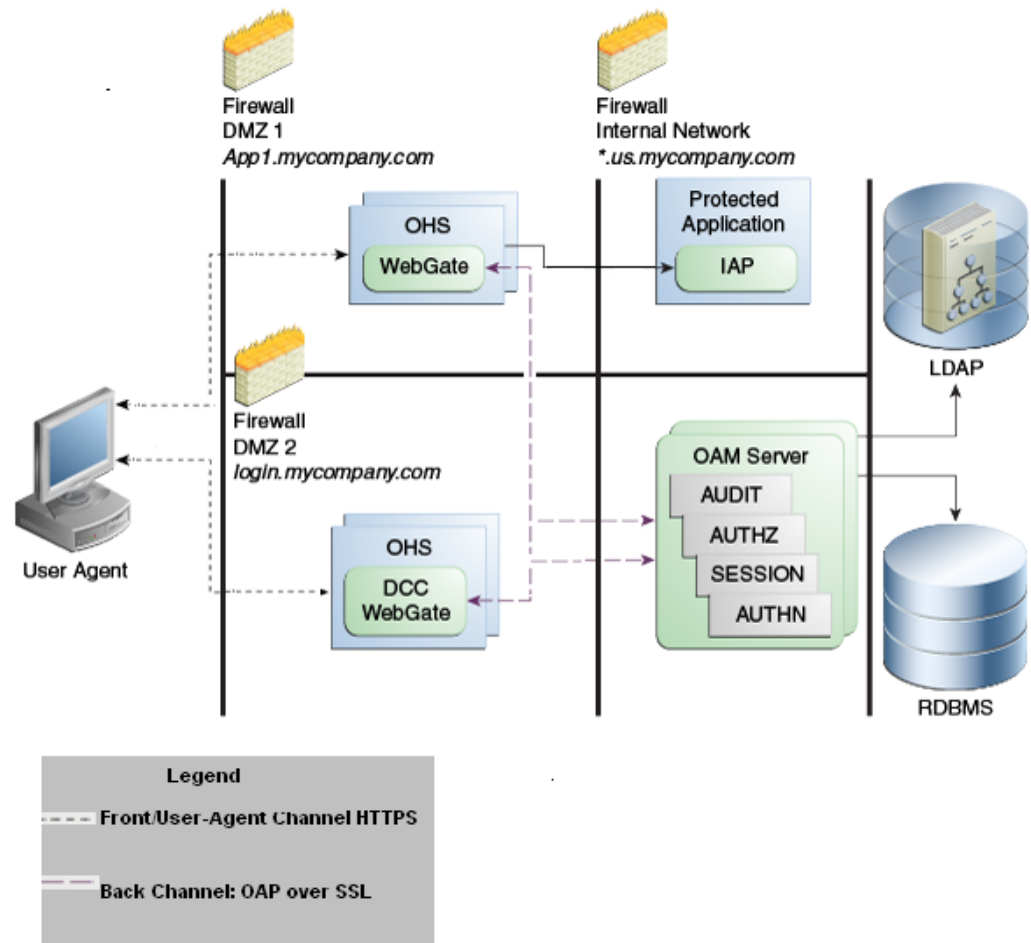
Figure 23-2 Example: Separate Resource WebGate and DCC WebGate Deployment

This topology (Figure 23-2) showcases choices appropriate for scenarios with maximum security sensitivity. Both centralized and externalized credential collection are used: Resource WebGates protecting applications are segregated from the DCC WebGate performing credential collection.

The user accesses the Access Manager-protected resource from the public network. A WebGate protecting the application is deployed within a DMZ. The DCC WebGate is also deployed within a DMZ. The protected application and OAM Server instances are located within the private network and not directly accessible from the public network.

Using the DCC in the DMZ, only authenticated network connections are allowed to reach the server itself. The DCC inherits all back-channel communication characteristics available to 11g WebGates (network connection using the Oracle Access Protocol). The OAP offers:

- SSL between the client and the server, optionally using 3rd party signed certificates
- mutual authentication at the application level using client id and password
- request multiplexing and full-duplex communication at the application level
- built-in connection load balancing and failover capability

The DCC receives an authentication request from the Agent and checks for the presence of the DCC cookie. If the cookie does not exist, credential collection is initiated; checks are made, and user-supplied credentials are passed for validation.

Note:

Encryption occurs only from an 11g resource WebGate to the DCC. The channel is not encrypted for communication between 10g resource WebGate and 11g DCC; this is in clear text.

Figure 23-3 Combined DCC and WebGate Configuration

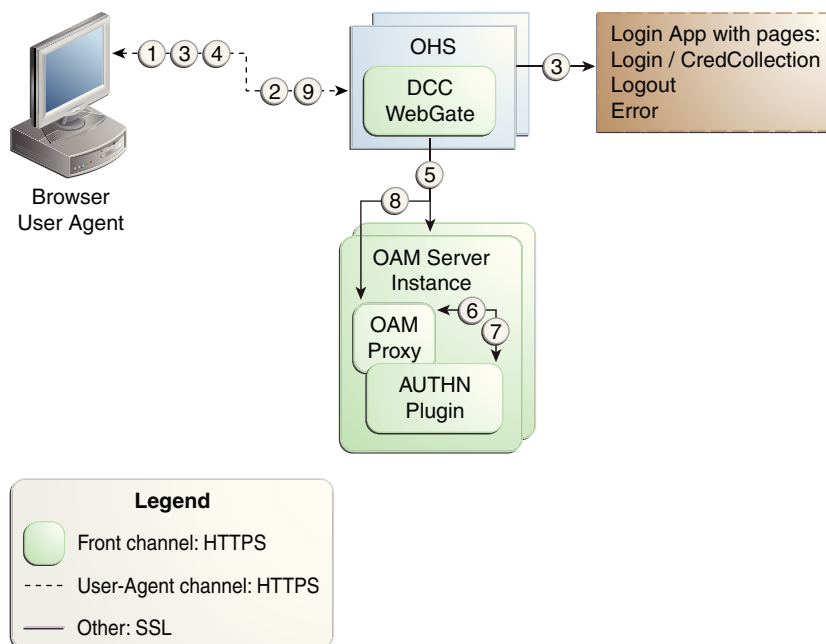

Process overview: Authentication with the combined DCC and Resource Webgate

1. The user requests access to a resource which initiates the authentication process.
2. The DCC redirects through the front channel to the login page.
3. The login page is returned to the user.
4. User enters credentials, which are posted to the action URL (a user-defined parameter in an authentication scheme, [Table 22-23](#)).
5. Authentication occurs using the back channel (OAP) and OAM Proxy.
6. The Authentication Plug-in is activated.
7. The Plug-in requests redirect to a URL to collect additional credentials.
8. The Plug-in request is returned to the DCC.
9. The DCC redirects to the URL and expects specified credentials.
10. The Browser follows the redirect.

11. Credentials are posted to the Action URL.

See Also:

["Configuring Logout When Using Detached Credential Collector-Enabled WebGate"](#)

23.4 Overview of the SSO Login Process with OSSO Agents (mod_osso) and ECC

SSO login processing with registered OSSO Agents (mod_osso) is similar to login processing with WebGates. However, mod_osso provides only authentication using Access Manager 11g authentication policies.

Note:

mod_osso does not support authorization either on its own or using Access Manager 11g policies.

[Figure 23-4](#) illustrates the login processing with mod_osso and Access Manager 11g.

Figure 23-4 SSO Login Processing with OSSO Agents and ECC

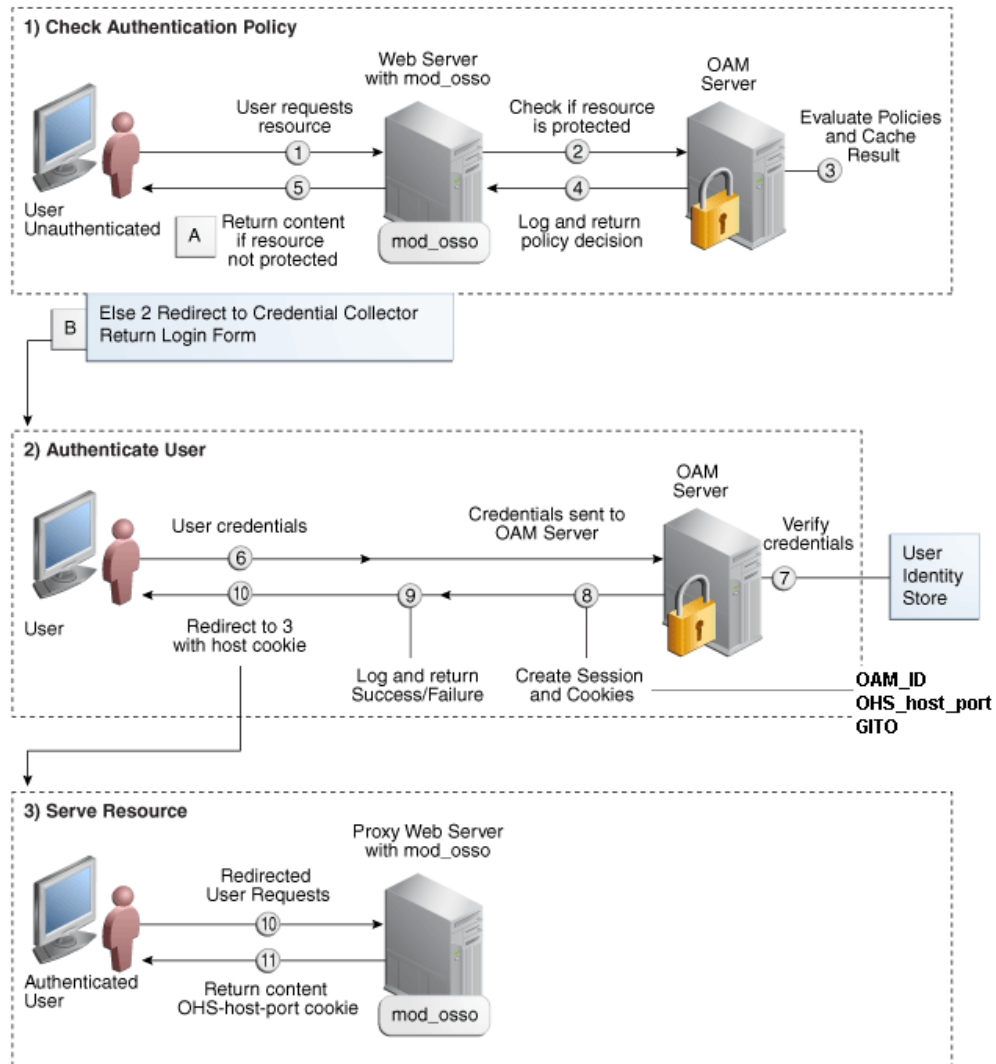

Process overview: SSO Log-in Processing with OSSO Agents and ECC

1. The user requests a resource.
2. mod_osso forwards the request to Access Manager for policy evaluation.
3. Access Manager:
 - Checks for the existence of an SSO cookie.
 - Checks policies to determine if the resource protected and if so, how?
4. OAM Server logs and returns decisions.
5. mod_osso responds as follows:
 - a. **Unprotected Resource:** Resource is served to the user.
 - b. **Protected Resource:** Request is redirected to the credential collector.

The login form is served based on the authentication policy.

Authentication processing begins

6. User sends credentials.
7. ECC verifies credentials.
8. Access Manager starts the session, passes an authentication token to the application, and creates the following cookies:
 - **One per partner:** OHS_host_port
 - **One for the OAM Server:** OAM_ID
 - **Global Inactivity Out:** A domain-level cookie GITO, described in [mod_osso Cookies](#).
9. Access Manager logs Success or Failure.
10. Credential collector redirects to mod_osso, which transmits the simple header values that applications can use to authorize the user.
11. Resource is served upon authentication success and the OHS-*host-port* cookie is set.

23.5 Configuring 11g WebGate and Authentication Policy for DCC

Administrators can enable DCC credential operations, update DCC forms for password policy, add PasswordPolicyValidationScheme to Authentication Policy, and use DCC for converged Federation flows.

The following steps describe configuring an 11g WebGate and Authentication Policy for use with the DCC. The appropriate sub sections are linked within each step.

1. [Enabling DCC Credential Operations](#) provides steps for either configuration:

DCC Combined with Resource Webgate: Enable Allow Credential Collector Operations in the DCC's OAM Agent registration page.

Separate DCC and Resource Webgate: Enable Allow Credential Collector Operations in the DCC's OAM Agent registration page and edit the Resource Webgate registration page to set the Logout Redirect URL to the DCC's logout.pl.

2. [Locating and Updating DCC Forms for Password Policy](#)

3. [Adding PasswordPolicyValidationScheme to Authentication Policy for DCC](#) provides steps for either configuration:

DCC Combined with Resource Webgate: In the combined DCC/Resource Webgate Application Domain, update the Protected Resources Authentication Policy to use your DCC Authentication Scheme.

Separate DCC and Resource Webgate: In the separate Resource Webgate Application Domain, update the Protected Resources Authentication Policy to use your DCC Authentication Scheme.

4. [Supporting Federation Flows With DCC](#) provides steps to incorporate the DCC into Federation flows.

Note:

If your environment uses the ECC, go to "[Completing Password Policy Configuration](#)".

23.5.1 Enabling DCC Credential Operations

Whether you are using a separate DCC or combined DCC and Resource WebGate, you must enable Allow Credential Collector Operations in the DCC's OAM Agent registration page.

With a separate DCC and Resource WebGate, you must also edit the Resource WebGate registration page to set the `Logout Redirect URL` to the DCC's `logout.pl`, as described in Step 3.

The following procedure presumes your deployment uses Open mode communication. If your deployment uses Simple or Cert mode communication, be sure to copy the appropriate artifacts when you perform Step 4.

Prerequisites

- [Configuring and Managing Registered OAM Agents Using the Console](#)
 - [Managing Global Password Policy](#)
 - [Configuring Password Policy Authentication](#) using DCC-specific details
1. In the Access Manager section of the Oracle Access Management Console, click SSO Agents to find and open the registration page for the 11.1.2 Webgate that will function as the DCC.
 2. **DCC WebGate Registration:** Check **Allow Credential Collector Operations**, click **Apply**, then perform Steps 4 and 5.

Note:

If the DCC is combined with a Resource WebGate, skip Step 3.

3. **Separate Resource WebGate:** Edit the Resource WebGate registration to set the `Logout Redirect URL` to the DCC's `logout.pl` ([Table 24-3](#)), click **Apply**, then perform Steps 4 and 5.
4. Copy Agent configuration file (including Simple or Cert mode files) from the AdminServer (Console) host to the Agent host. For example:

Agent & Artifacts	Artifacts
11g WebGate/ Access Client	From the AdminServer (Console) host:
ObAccessClient.xml and	<code>\$DOMAIN_HOME/output/\$Agent_Name/</code>
cwallet.sso	To the Agent host: <code>\$11gWG_install_dir/webgate/config</code>

Agent & Artifacts	Artifacts
Simple or Cert Mode	Copy to the Agent host: <code>\$11gWG_install_dir/webgate/config</code> <ul style="list-style-type: none"> • <code>aaa_key.pem</code> • <code>aaa_cert.pem</code> • <code>aaa_chain.pem</code> • <code>password.xml</code> See Also: Securing Communication

5. Restart the OHS Web server.
6. Proceed to "[Locating and Updating DCC Forms for Password Policy](#)".

23.5.2 Locating and Updating DCC Forms for Password Policy

Access Manager provides several dynamic pages for user interactions with the DCC.

See Also:

Oracle Fusion Middleware Developer's Guide for Oracle Access Management

Prerequisites

[Enabling DCC Credential Operations](#)

1. Locate the DCC forms in the WebGate host ([Table 24-3](#)): `$WEBGATE_HOME/webgate/ohs/oamssso/*`, `$WEBGATE_HOME/webgate/ohs/oamssso-bin/*pl`, and `$WEBGATE_HOME/webgate/ohs/oamssso-bin/templates/*`.
2. Customize their location, depending on the desired topology of the authentication scheme being developed.
3. **Update Perl Location:** Update the Perl location to be consistent with the actual location, in the first line of the login, logout, and securid scripts on Webgate host in `$WEBGATE_HOME/webgate/ohs/oamssso-bin/*pl` ([Table 24-3](#)).
4. Customize the default pages for your enterprise, or replace them entirely with custom pages. For example, you can design, implement, and deploy a custom page that displays a different version of the login form for a mobile browser than is used for a desktop browser.
5. Proceed to "[Adding PasswordPolicyValidationScheme to Authentication Policy for DCC](#)".

23.5.3 Adding PasswordPolicyValidationScheme to Authentication Policy for DCC

You can use your DCC Authentication Scheme in a Protected Resources Authentication Policy.

The steps you perform depend on the type of deployment you have:

- **Combined DCC/Resource WebGate:** Perform Step 1 to add your DCC Authentication Scheme to the Protected Resources Authentication Policy of the combined DCC/Resource WebGate Application Domain.

- **Separate Resource WebGate:** Perform Step 3 to add your DCC Authentication Scheme to the Protected Resources Authentication Policy of the separate Resource WebGate Application Domain.

Perform Step 2 regardless of your DCC deployment type. By default, login and logout forms are excluded through OHS /httpd.conf/webgate.conf so that you do not need to exclude them through policies. However, with the Chrome browser, you must explicitly exclude the async favicon.ico request (which overrides the DCCtxCookie).

Note:

This example refers to the PasswordPolicyValidationScheme set for the DCC in [Configuring Password Policy Authentication](#) .

Prerequisites

[Locating and Updating DCC Forms for Password Policy](#)

1. **Combined DCC/Resource WebGate:** Open the DCC application domain:
 - Policy Configuration
 - Application Domains
 - DCCDomain*
 - a. Locate and open the **Authentication Policy, Protected Resource Policy** (see "[Searching for an Authentication Policy](#)").
 - b. Add your **DCC Authentication Scheme** to this policy (see "[Defining Authentication Policies for Specific Resources](#)").
 - PasswordPolicyValidationScheme** (DCC Authentication Scheme)
 - c. Perform Step 2 if you have the Chrome Browser. Otherwise, go to Step 4.
2. **Chrome Browser:** Add and exclude resource /favicon.ico in the *DCCDomain*, as follows.
 - a. From *DCCDomain*, click the **Resources** tab.
 - b. Find and open the HTTP resource /favicon.ico (or click the New Resource button and then add this resource).
 - c. Confirm or edit the Resource URL to:
 - /favicon.ico
 - d. In the **Protection** section, **Protection Level** list, select **Excluded**, then click **Apply**.
 - e. Proceed to Step 4.
3. **Separate Resource Webgate:** Open the Resource Webgate application domain.
 - Policy Configuration
 - Application Domains
 - ResourceWGDomain*

- a. Locate and open the **Authentication Policy, Protected Resource Policy** (see ["Searching for an Authentication Policy"](#)).
- b. Add your **DCC Authentication Scheme** and an optional Failure URL (when not specified, Failure URL displays the default error page) to this policy (see ["Defining Authentication Policies for Specific Resources"](#)):
 - DCC Authentication Scheme**
 - Failure URL** (optional)
- c. Perform Step 2 if you have the Chrome Browser. Otherwise, go to Step 4.
4. Restart your Web server and proceed to ["Completing Password Policy Configuration"](#).

See Also:

["Configuring Logout When Using Detached Credential Collector-Enabled WebGate"](#)

23.5.4 Supporting Federation Flows With DCC

The DCC is enhanced to work as a public end-point to the Access Manager server. HTTP requests to the DCC are tunneled through NAP to the proxy module of the Access Manager server. Only requests defined in the TunneledUrls parameter of the DCC Profile will be tunneled. The JSP pages and servlets are executed in the Access Manager server and the response is tunneled back to the DCC. The end user effectively communicates only to the DCC.

Note:

If a WebGate is configured as a DCC and federated flows are in use, the DCC WebGate cannot be used to protect the resource. A separate WebGate must be configured and used to protect the resource. Authentication and authorization requests will be tunneled to the OAM Server, and the ECC login form will be tunneled and displayed in the user's browser.

To use DCC for converged Federation flows, perform the following manual steps.

1. Configure the following internal resources as Public instead of Excluded.

```
/oamfed/.../*
/oam/.../*
/.../*
```
2. In the DCC WebGate, set the logout value to a valid DCC WebGate logout URL; for example, `/oamsso-bin/logout.pl`
3. Update the DCC Agent entry by adding the following entry to the User Defined Parameters list using the Access Manager Administration Console.

```
TunneledUrls=/oam,/oamfed
```

See [Configuring OAP Tunneling](#).

4. Update the OAM public endpoint entry so that it points to the DCC WebGate.

Under Access Manager Settings, set the OAM Server Host, OAM Server Port and OAM Server Protocol to the values pertinent to the OHS/DCC and click Apply.

Note:

Alternately you can update a single Authentication Scheme to point to the DCC WebGate by altering the challenge redirect URL leaving the REST parameters unchanged.

5. Update the ProviderID value under Federation Settings (if applicable) and redistribute the new metadata to all Federation partners due to the endpoint change.
6. Set the contextType to 'External'.

See [Authentication Schemes and Pages](#) for details on this setting.

23.6 Tunneling from DCC to Access Manager Over Oracle Access Protocol

Access Manager supports HTTP communication over the Oracle Access Protocol (OAP). In this case, a WebGate configured as a DCC uses the ECC servlets for credential collection during Access Manager authentication.

The following sections contain more details.

- [How DCC Tunneling with OAP Works](#)
- [Configuring OAP Tunneling](#)

Note:

For details on the DCC, see [Embedded Credential Collector Versus Detached Credential Collector](#).

23.6.1 How DCC Tunneling with OAP Works

The tunneling process works for DCC WebGates only.

[Figure 23-5](#) illustrates how the tunneling process works.

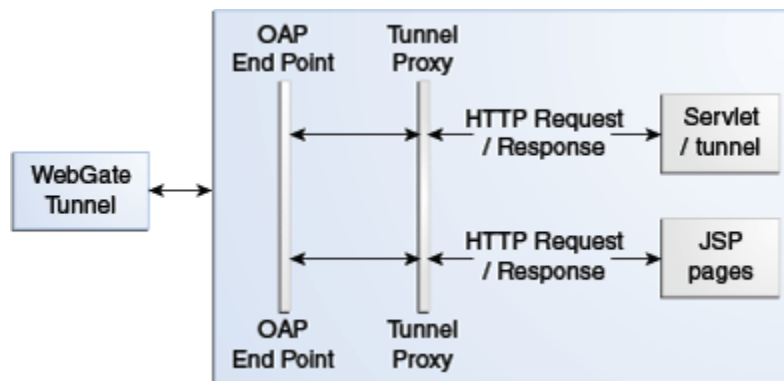
Figure 23-5 OAP Tunneling with DCC

The following steps provide more details in regards to the OAP Tunneling process.

1. The URL to be tunneled is configured in the DCC WebGate profile.
2. This same URL is mapped to a servlet or JSP page in the Access Manager server.
3. On accessing the tunneled URL, the WebGate intercepts the HTTP request and converts it to an OAP request.
4. The OAP request is forwarded to the Access Manager server.
5. The Access Manager server (OAM proxy) receives the OAP request and passes it to the tunnel proxy.
6. The tunnel proxy will convert the OAP request to an `HttpServletRequest` and invoke the corresponding servlet (or compiled servlet in the case of a JSP).
7. The response is converted back to an OAP message and passed to the OAP end point.
8. The OAM end point responds to the WebGate with the converted OAP message.
9. The WebGate converts the OAP message back to an HTTP response.
10. The WebGate provides the HTTP response to the caller (browser).

23.6.2 Configuring OAP Tunneling

To configure OAP Tunneling, a WebGate must be installed and configured to work with the Access Manager server as a DCC.

The Access Manager endpoint must be deployed on the Access Manager Server. After ensuring these prerequisites have been met, add a user-defined parameter to the WebGate profile that defines all URLs to be tunneled using the form `TunneledUrls=<URL> , <URL1>`. For example:

```
TunneledUrls=/oam,/sampleapp
```

Lastly, protect the Tunneled URLs with an Authentication Policy. For details, see [Managing Authentication and Shared Policy Components](#).

23.7 Configuring a DCC WebGate for X509 Authentication

Configure a WebGate for DCC and convert it to SSL for using it with X509 authentication.

1. [Configuring the WebLogic Server](#)
2. [Configuring a WebGate For DCC](#)
3. [Converting the DCC WebGate to SSL](#)

23.7.1 Configuring the WebLogic Server

Use the procedures in the following sections to configure a WebLogic Server for X509 authentication.

1. [Creating the Server and Trust Store](#)
2. [Configuring the WebLogic Server Instance](#)
3. [Creating the User Certificate](#)
4. [Adding the Root CA Certificate](#)

23.7.1.1 Creating the Server and Trust Store

These are common procedures for WebLogic Server.

1. Create Server certificate

Create a Server Certificate and key for the WLS domain on which Oracle Access Management 11g is deployed. This entails requesting a certificate (in which the Common Name is the OAM server machine name), having the certificate signed and converting it to the P12 format. The Server certificate can be created and signed using any Certificate utility.

2. Create the server store and the trust store using keytool.

See [Securing Communication Between OAM Servers and WebGates](#) for details.

23.7.1.2 Configuring the WebLogic Server Instance

Use the WebLogic console to configure the instance of the WebLogic Server to be SSL and client certificate enabled.

1. Navigate to the server instance which is to be SSL and Client Cert enabled.

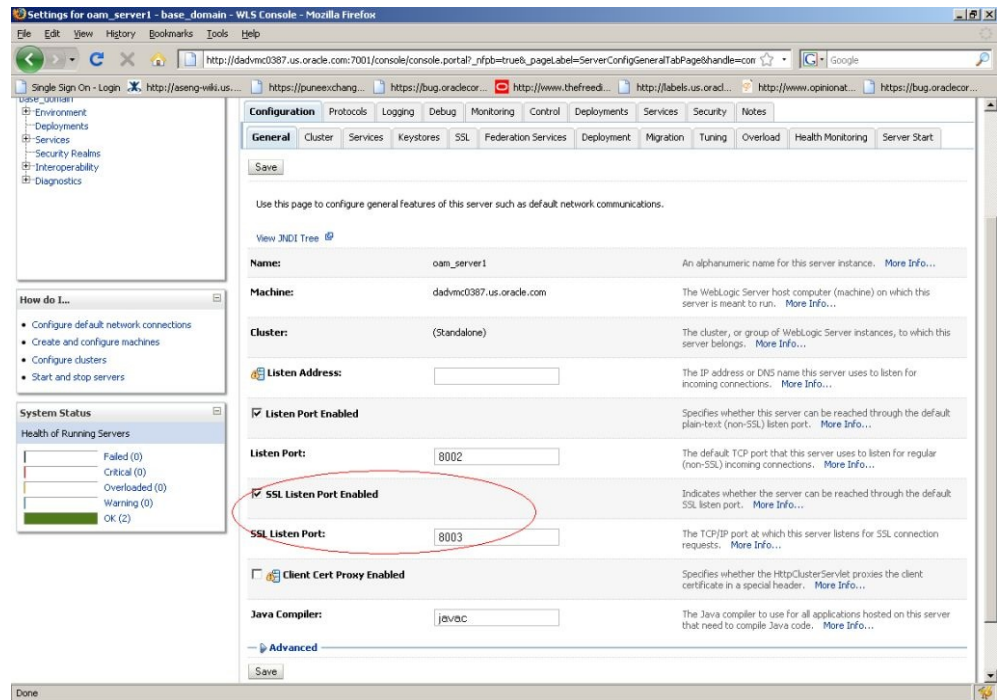
Figure 23-6 Enable SSL

2. Check the SSL Listen Port Enabled check box and provide the port number as in [Figure 23-6](#).
3. Provide the server and trust keystore path under the "Keystore" tab.

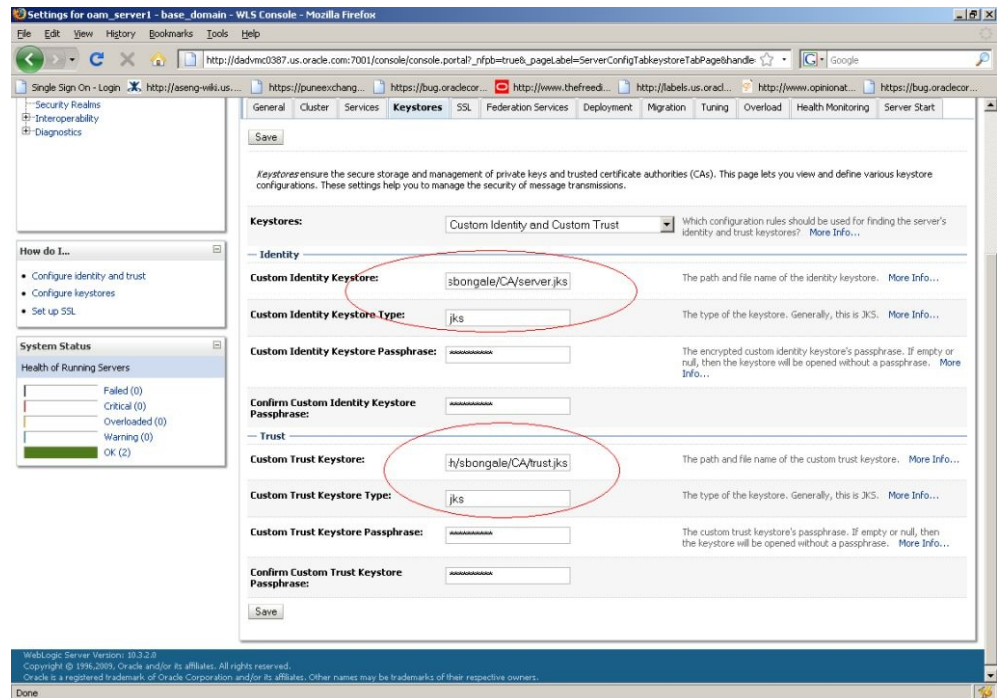
Figure 23-7 Keystore Configuration

4. Add the private key alias details under the SSL tab.

The alias name is same name specified as the server store name in [Creating the Server and Trust Store](#).

Figure 23-8 Add Private Key Alias

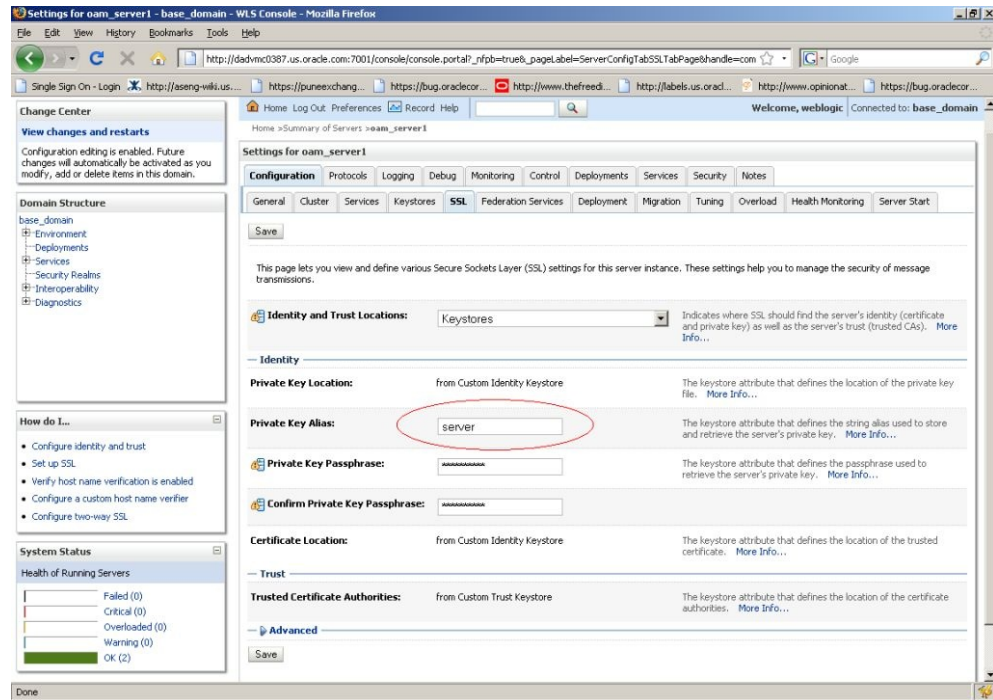

5. Display the Advanced options under the SSL tab and make the configurations illustrated in [Figure 23-9](#).

Figure 23-9 SSL Advanced Options

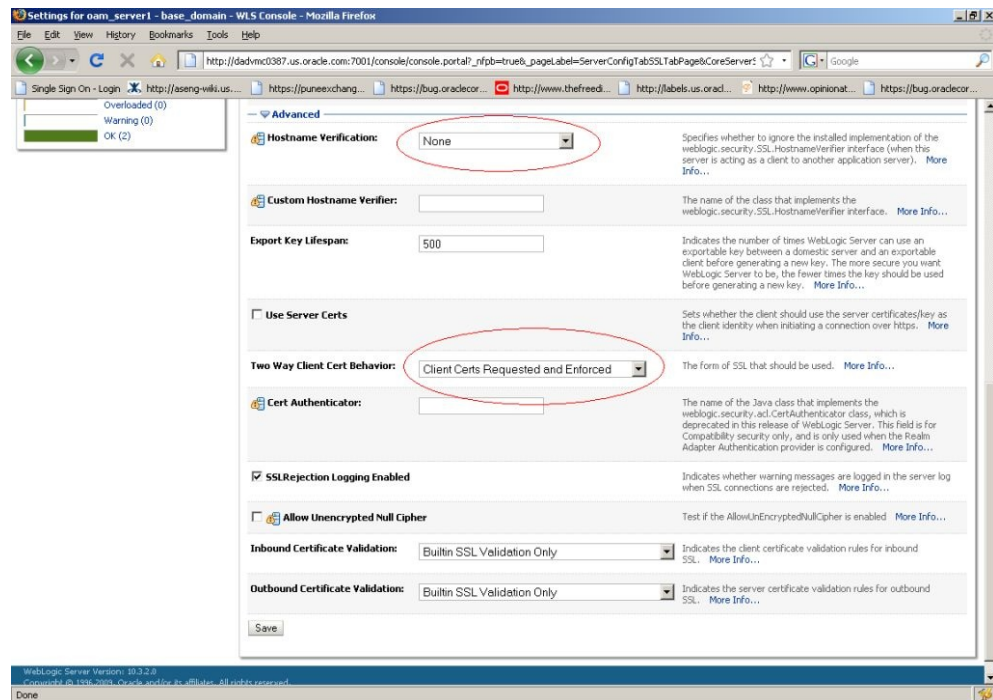

23.7.1.3 Creating the User Certificate

You can create a user certificate in the .p12 format and install it in your browser.

Run the following OpenSSL commands:

1. `openssl req -config openssl.cnf -new -out weblogic.csr`

Provide the certificate details. The Common Name is the name of the user for whom the certificate is requested.

2. `openssl x509 -req -md5 -CAcreateserial -in weblogic.csr -days 180 -CA`

```
F:\openssl\simpleCA\ca.pem -CAkey F:\openssl\simpleCA\ca-key.pem -extfile
```

```
F:\openssl\openssl.cnf -out weblogic.pem
```

3. `openssl rsa -in privkey.pem -out weblogic.key`
4. `openssl pkcs12 -export -in weblogic.pem -inkey weblogic.key -out user1k1.p12`
5. Install the .p12 formatted certificate output in your browser.

23.7.1.4 Adding the Root CA Certificate

You can add the Root CA certificate of the certificate utility used to SSL enable the WebLogic server.

(In this example, the OpenSSL certificate utility is used.) The Root CA certificate must be added to the .oamkeystore and amtruststore files located in the following WebLogic directory:

```
$DOMAIN_HOME/base_domain/config/fmwconfig
```

1. Retrieve the password for the .oamkeystore and amtruststore files in WebLogic.
 - a. Navigate to `$MIDDLEWARE_HOME/Oracle_IDM1/common/bin/`.
 - b. Run `wlst.sh`.
 - c. Run `connect()` in the WLST shell.
 - d. Run `domainRuntime()` in the WLST shell.
 - e. Run `listCred(map="OAM_STORE",key="jks")` in the WLST shell to display the password.
2. Add the Root CA certificate to the .oamkeystore and amtruststore files using the `keytool` command.

The value of `-storepass` is the password retrieved in the previous step. For example:

```
./keytool -importcert -alias ROOT_CA -file /scratch/CA/ca.pem -keystore /scratch/Oracle/Middleware/user_projects/domains/base_domain/config/fmwconfig/.oamkeystore -storepass oru8nd3hhd4t4nrnh6unhv825b -storetype jceks
```

```
./keytool -importcert -alias ROOT_CA -file /scratch/CA/ca.pem -keystore /scratch/
```

```
Oracle/Middleware/user_projects/domains/base_domain/config/fmwconfig/  
amtruststore -storepass oru8nd3hhd4t4nrmh6unhv825b -storetype jks
```

23.7.2 Configuring a WebGate For DCC

You can configure a WebGate for DCC. As part of this procedure you will also create the LDAPScheme_DCC Authentication Scheme.

You will use the Oracle Access Management Console for the configuration steps. This procedure assumes you have already installed the WebGates for which you will be creating profiles.

1. Configure an 11g WebGate profile named, for example, ABC_WG1 on `http://<host>:7778/index.html`.
2. Configure an 11g WebGate profile named, for example, XYZ_WG1_DCC on `http://<host>:7779/index.html`.

This WebGate will act as the authentication WebGate.

3. Navigate to the XYZ_WG1_DCC WebGate profile and Select Allow Credential Collector Operations Option.

This configures the WebGate for use as a DCC.

4. Create a new Authentication Scheme by making a copy of the LDAPScheme Authentication Scheme and modifying the following values.

Only modify the following values; leave the other parameters untouched.

- a. Name as LDAPScheme_DCC
 - b. Challenge redirect URL is `http://<host>:<port>/` (`http://<host>:7779/`)
 - c. Challenge URL : `/oamssso-bin/login.pl`
5. Navigate to the ABC_WG1 Application Domain and do the following.
 - a. Go to Authentication Policy.
 - b. Select Authentication Policy (Protected Resource Policy).
 - c. Select the newly created Authentication Scheme LDAPScheme_DCC.
 6. Restart the Oracle HTTP Server with port 7779 in use.
 7. Access the protected resource at `http://<host>:7778/index.html`.

You should get challenge page from the authenticating WebGate server (port 7779). After providing valid credentials, the resource on the port 7778 server should be displayed.

23.7.3 Converting the DCC WebGate to SSL

You can convert the DCC WebGate instance to SSL.

The following sections have details.

- [Generating Server Certificates](#)
- [Generating and Importing Client Certificates](#)

23.7.3.1 Generating Server Certificates

You can generate server certificates using Oracle Wallet Manager (OWM).

1. Create a Wallet using OWM.
 - a. Start OWM.

```
$ <webtier>/bin/owm
```
 - b. Select Wallet > New and follow the on screen instructions to create a Certificate Request.
 - c. Save the created Wallet in an accessible location and write down the path for future reference.
 - d. Select the Auto Login option and save the Wallet again.

2. Create and export the server request file as server.csr using OWM.

- a. Select Operations > Export Certificate Request.
- b. Save as server.csr

3. Sign server.csr to generate user certificate server.pem.

You can use the OpenSSL utility as follows:

```
openssl x509 -req -md5 -CAcreateserial -in ohs_server.csr -days 3656 -CA /  
  <path>/ca.pem -CAkey /<path>/ca-key.pem -out server.pem
```

The values of ca.pem and ca-key.pem should be the same ones used when generating the client certificate.

4. Import the CA certificate (ca.pem) into OWM.

- a. Select Operations > Import Trusted Certificate.
- b. Point to ca.pem, your CA certificate.
- c. Import the CA certificate and save the wallet.

5. Import server.pem as user cert

- a. Select Operations > Import User Certificate.
- b. Point to the server.pem certificate generated in step 3.
- c. Import the server certificate and save the wallet.

6. Edit the Oracle HTTP Server (OHS) ssl.conf file to point to this wallet as follows.

```
#Path to the wallet  
SSLWallet "/<path to wallet>/wallet"  
SSLVerifyClient require
```

ssl.conf is located at <webtier>/<instance_home>/config/ohs/ssl.conf.

7. Restart the OHS instance.

23.7.3.2 Generating and Importing Client Certificates

You can generate and import client certificates and create a new X509 authentication scheme.

1. Create a user certificate by following the steps documented in [Creating the User Certificate](#).
2. Create a new Authentication Scheme named X509_DCC as illustrated in [Figure 23-10](#).

Add a Challenge Redirect URL. The Challenge URL should be blank.

Figure 23-10 New X509 Scheme

The screenshot shows the Oracle Access Management console interface for configuring a new authentication scheme. The page title is "X509Scheme_dcc_vivek Authentication Scheme". Below the title, there are buttons for "Set As Default", "Duplicate", and "Apply". The form contains the following fields:

- Name:** X509Scheme_dcc
- Description:** X509 Scheme
- Authentication Level:** 5
- Default:**
- Challenge Method:** X509
- Challenge Redirect URL:** https://slc04icl.example.com:4448
- Authentication Module:** X509
- Challenge URL:** /
- Context Type:** (dropdown menu)
- Challenge Parameters:** (text area)

Annotations in the image point to the "Challenge Redirect URL" and "Challenge URL" fields, stating: "Challenge Redirect URL : https://<OHS host>:<OHS ssl port>/oam/CredCollectServlet/X509" and "Challenge URL should be blank." respectively.

3. Import <user_cert>.p12 into your browser.
4. Access the protected resource via its SSL port. For example:

https://<ohs_host>:<ohs_port>/index.html

A popup is displayed asking which certificate to use. Select the appropriate certificate and the requested resource is accessed.

Using Password Policy

Access Manager provides several pages for user interactions during credential collection. This includes login, error and password forms.

This chapter contains details on these forms and how to configure a password policy.

- [Understanding Password Management](#)
- [Enabling Password Management](#)
- [Accessing Password Policy Configuration Page](#)
- [Specifying Credential Collector URLs with Password Policy](#)
- [Oracle-Provided Password Forms](#)
- [Managing Global Password Policy](#)
- [Configuring Password Policy Authentication](#)
- [Completing Password Policy Configuration](#)
- [Configuring the IPFUserPasswordPolicyPlugin](#)

24.1 Understanding Password Management

The Password Management feature is only supported when the identity store used is an LDAP directory.

When enabled, Password Management can be used for the following scenarios.

- When a user account is disabled by an administrator, the user is not allowed to enter the system. An appropriate error message is displayed if the user requests access.
- When a user account is locked by an administrator (whether permanently or temporarily due to incorrect passwords or challenges), the user is not allowed to enter the system. An appropriate error message is displayed if the user requests access.
- A user can be forced by the administrator to change a password if specific values are set in the user's LDAP entry.
- When a user has to change a soon-to-be expiring password, a screen is displayed from which the user can choose one of the following options: change the password now or continue to the requested page without changing the password.
- If a user submits a password with invalid characters during a password reset operation, an error message can be displayed with the password creation rules that the user must follow.

[Oracle-Provided Password Forms](#) has screenshots of the error messages discussed.

Caveats for Integrated Deployments

When you are using Oracle Identity Management and Oracle Access Management with Oracle Internet Directory, there are two sets of password policy definitions and enforcement. Password Policy Definition can be configured in both Oracle Identity Management and in Oracle Internet Directory. Password Policy Enforcement occurs according to the following:

- Oracle Access Management enforces state policies (incorrect password, for example) during Web access; Oracle Internet Directory enforces its own state policies as well as LDAP operations (bind and compare, for example).
- Oracle Identity Management enforces value policies (characteristics of the password) during user creation of the password update; Oracle Internet Directory enforces its own value policies as well for policies for LDAP operations (add, modify for example).

Password Policy is only certified when the configured Identity Store is an LDAP directory. It is not certified with a virtualized LDAP directory (for example, Oracle Virtual Directory fronting another data repository) or a non LDAP directory

Any LDAP directory (such as Oracle Internet Directory) has a way to configure password policies that define lexical constraints to which the user password must conform (minimum characters, maximum length of time the password is valid, use of special characters, etc.) This password policy gets applied when the user's password is changed in the LDAP directory. To make sure that this LDAP directory password policy does not conflict with the password policy configured in OAM, the administrator has to manually study the LDAP password policy and do one of the following.

1. Make the backend LDAP identity store policies weaker or the same strength as the Oracle Identity Management and Oracle Access Management policies. However, this leads to a double enforcement.
2. Disable native LDAP password policy validation, which unfortunately leaves no enforcement for direct LDAP operations.

24.2 Enabling Password Management

Use the Oracle Access Management Console to enable the Password Management service. This is done as a configuration of the defined user identity store.

The Password Management feature is only supported when the identity store used is an LDAP directory.

1. Log in to the Oracle Access Management Console as Administrator.
2. Click Configuration at the top right of the Oracle Access Management Console.
3. Click User Identity Stores in the Configuration console.
4. Select the appropriate LDAP directory to enable Password Management.

Alternately, click Create to register a user identity store. See [Managing Data Sources](#) for details.

5. Under Password Management, check Enable Password Management.

6. Define the Password Management parameters and click Apply to save.

[Table 24-1](#) documents the parameters used for configuration.

Table 24-1 Password Policy Configuration Parameters

Parameter	Description
Enable Password Management	Enables password management for this identity store. If password management is not enabled, the password plugin returns right away and the status is not captured.
Use Oblix Schema	If checked, the Oblix schema is used. If not, the Oracle Schema is used.
Global Common ID Attribute	This is the userid attribute used for password policy verification to make sure the password doesn't contain the user id attribute value.
First Name Attribute	This is the first name attribute used for password policy verification to make sure the password doesn't contain the first name attribute value.
Last Name Attribute	This is the last name attribute used for password policy verification to make sure the password doesn't contain the last name attribute value.
Email Address Attribute	This is the email attribute of the users in this identity store. It is used for password policy verification.

24.3 Accessing Password Policy Configuration Page

Once Password Management is enabled, you can configure the Password Policy. Administrators define password policy based on enterprise requirements. When configured, the Password Options and Challenge Options are used by both the Embedded Credential Collector (ECC) and Detached Credential Collector (DCC).

See [Understanding Credential Collection and Login](#) for information on the Credential Collection options.

Follow this procedure to access the Password Policy configuration page.

1. Log in to the Oracle Access Management Console as Administrator.
2. Click Application Security at the top right of the Oracle Access Management Console.
3. Click Password Policy in the Application Security console. For detailed information about the options see, [Password Policy Configuration Page](#).

24.3.1 Password Policy Configuration Page

Various options are available on the password policy configuration page.

Figure 24-1 Password Policy Configuration Page

This password policy will be applied to all resources protected by Oracle Access Management. Specify the password policy's details.

▲ Password Options

Minimum Uppercase Characters <input type="text" value=""/> ^ v	
Minimum Lowercase Characters <input type="text" value=""/> ^ v	
Minimum Alphabetic Characters <input type="text" value=""/> ^ v	
Minimum Numeric Characters <input type="text" value=""/> ^ v	
Minimum Alphanumeric Characters <input type="text" value=""/> ^ v	
Minimum Special Characters <input type="text" value="1"/> ^ v	Maximum Special Characters <input type="text" value=""/> ^ v
Minimum Unicode Characters <input type="text" value=""/> ^ v	Maximum Unicode Characters <input type="text" value=""/> ^ v
Minimum Password Length <input type="text" value="1"/> ^ v	Maximum Password Length <input type="text" value=""/> ^ v
Minimum Unique Characters <input type="text" value=""/> ^ v	Maximum Repeated Characters <input type="text" value=""/> ^ v
Minimum Password Age (days) <input type="text" value=""/> ^ v	

Characters Required <input type="text"/>	
Characters Not Allowed <input type="text"/>	
Characters Allowed <input type="text"/>	
Substrings Not Allowed <input type="text"/>	

Alphabetic Character Must Start Password <input checked="" type="checkbox"/>	Can Include User's Last Name <input type="checkbox"/>
Can Include User's First Name <input checked="" type="checkbox"/>	Can Include User ID <input type="checkbox"/>
Warn After (days) <input type="text" value=""/> ^ v	* Maximum Attempts <input type="text" value="3"/> ^ v
Expire After (days) <input type="text" value=""/> ^ v	Permanent Lockout <input checked="" type="checkbox"/>
Disallow Previous Passwords <input type="text" value=""/> ^ v	Lockout Duration (minutes) <input type="text" value=""/> ^ v

Password Dictionary File <input type="text"/>	
Password File Delimiter <input type="text"/>	
Password Service URL <input type="text" value="/oam/pages/pswd.jsp"/>	

Table 24-2 describes the configurable Password Policy options (as read from left to right in the console). These elements are used by both the ECC and DCC.

Table 24-2 Password Policy Elements

Element	Description
Minimum Uppercase Characters	Defines the minimum number of uppercase characters required in a password.
Minimum Lowercase Characters	Sets the minimum number of lowercase characters required in a password.
Minimum Alphabetic Characters	Defines the minimum number of special characters allowed in the password.
Minimum Numeric Characters	Sets the minimum number of numeric characters required in a password.
Minimum Alphanumeric Characters	Defines the minimum number of alphanumeric characters required in a password.

Table 24-2 (Cont.) Password Policy Elements

Element	Description
Minimum Special Characters	Sets the minimum number of special characters required in a password.
Maximum Special Characters	Defines the maximum number of special characters allowed in a password.
Minimum Unicode Characters	Defines the minimum number of unicode characters required in a password.
Maximum Unicode Characters	Sets the maximum number of unicode characters allowed in a password.
Minimum Password Length	Sets the total minimum number of characters required in a password.
Maximum Password Length	Defines the total maximum number of characters allowed in a password.
Characters Required	Defines the specific characters that are required in a password. No delimiter is needed or allowed in this definition.
Characters Not Allowed	Sets the specific characters that cannot be used in a password. No delimiter is needed or allowed in this definition
Characters Allowed	Defines all allowed characters in a password. No delimiter is needed or allowed in this definition
Substrings Not Allowed	Specific character strings that are not allowed in a password. Use a comma as the delimiter in this definition.
Alphabetic Character Must Start Password	Specifies that the first character in a password must be alphabetic, when checked.
Can Include User's Last Name	Specifies that the user's last name is allowed in the password, when checked.
Can Include User's First Name	Specifies that the user's first name is allowed in the password, when checked.
Can Include User ID	Specifies that the user's userID is allowed in the password, when checked.
Warn after (days)	Defines the number of days before a designated date in which a user will be warned about password expiration. For example, you enter 30 in the Expires After (Days) field, and 20 in the Warn After (Days) field, and the password is created on November 1. On November 21, the user will be informed that the password will expire on December 1. This field accepts values from 0 to 999.
Maximum Attempts	Identifies the maximum number of login attempts a user can make before a lockout.
Expire after (days)	Defines the period of time (in days) that the password is valid.

Table 24-2 (Cont.) Password Policy Elements

Element	Description
Lockout Duration (minutes)	Identifies the period of time the user is locked out (in minutes) after the designated number of failed login attempts. After this period, the user can attempt a fresh login.
Permanent Lockout	specifies permanent lockout after the designated number of failed login attempts.
Disallow Last	Defines the number of previous passwords that cannot be used when the user changes her password.
Password Dictionary File	Identifies the physical file on OAM Servers that contain the list of restricted words that can not be specified in a password.
Password File Delimiter	Defines the delimiter used in the Password Dictionary file to separate various words. For example, if the file contains <code>abc,def,welcome</code> and the dictionary delimiter is comma (<code>,</code>), the words that are restricted and cannot be used in a user password are <code>abc</code> , <code>def</code> and <code>welcome</code> .
Password Service URL	The location of various password pages.

24.4 Specifying Credential Collector URLs with Password Policy

Regardless of the credential collection method, you can configure one global password policy that applies to all Access Manager-protected resources (using the Password Policy Validation Module in the authentication scheme).

The relevant URLs for the credential collector and related forms must be specified as outlined in [Table 24-3](#).

Table 24-3 Specifying Credential Collectors and Related Forms for Authentication

In the . . .	For the ECC . . .	For the DCC . . .
OAM Agent Registration <i>DCC Only</i>	N/A.	Check the box beside Allow Management Operations in the OAM Agent registration page. See Also: "Enabling DCC Credential Operations"

Table 24-3 (Cont.) Specifying Credential Collectors and Related Forms for Authentication

In the . . .	For the ECC . . .	For the DCC . . .
login, error, and password pages	<p>Pages where the user enters credentials arrive out of the box on the OAM Server and require no additional settings or changes.</p> <ul style="list-style-type: none"> • Login page: /pages/login.jsp • Logout page: /pages/logout.jsp • Error page: /pages/servererror.jsp • Multi-step authentication: /pages/mfa_login.jsp 	<p>Dynamic pages for general login/logout and password policy with the DCC are excluded automatically through the OHS httpd.conf/webgate.conf file--you do not need to configure a policy to exclude these.</p> <p>See WebGate host directories \$WEBGATE_HOME/webgate/ohs/oamssso/*, \$WEBGATE_HOME/webgate/ohs/oamssso-bin/*pl, and \$WEBGATE_HOME/webgate/ohs/oamssso-bin/templates/* for:</p> <ul style="list-style-type: none"> • Login page: /oamssso-bin/login.pl • Logout: /oamssso-bin/logout.pl • RSA SecurID login pages: /oamssso-bin/securid.pl <p>Perl Scripts for DCC-based Login and Logout</p> <p>The path name of the Perl executable must be updated in Oracle-provided Perl scripts on the WebGate host \$WEBGATE_HOME/webgate/ohs/oamssso-bin/*pl to be consistent with the actual location.</p> <p>See Also: Table 22-5</p>
Password Policy, Password Service URL	<p>The Default/ECC password page is used automatically:</p> <p>Password Service URL for ECC: /oam/pages/pswd.jsp</p> <p>See Also: "Defining Your Global Password Policy"</p>	<p>Enter the DCC password page: Password Service URL for DCC: /oamssso-bin/login.pl</p> <p>See Also: "Locating and Updating DCC Forms for Password Policy"</p>
User Identity Store	<p>The user data object definition in the Access Manager schema is extended with attributes that enable password user status and password history maintenance. This definition is provided in an LDIF file, and must be added to each user identity store using the ldapadd tool. Oracle-provided LDIFs are identified in Table 24-6.</p>	<p>Same for both DCC and ECC:</p> <p>See Also:</p> <ul style="list-style-type: none"> • "Adding Key Password Attributes to the Default Store" • "Adding an Administrator to Change User Attributes After a Password Change"
Password Policy Validation Authentication Module	<p>Enter the Default Store as the KEY_IDSTORE_REF for each of the three plug-ins / steps (with an Error redirect on Failure):</p> <p>See Also:</p> <ul style="list-style-type: none"> • Table 22-13 • "Password Policy Validation Authentication Module" 	<p>Same for both DCC and ECC:</p>

Table 24-3 (Cont.) Specifying Credential Collectors and Related Forms for Authentication

In the . . .	For the ECC . . .	For the DCC . . .
Authentication Scheme, Challenge Redirect URL	Enter the Credential Collector host: <ul style="list-style-type: none"> • For ECC, relative URI format: /oam/server (server prepends the <i>host:port</i>) See Also: " Configuring the PasswordPolicyValidationScheme "	Enter the Credential Collector host: <ul style="list-style-type: none"> • For DCC, full URL: http://<i>dchost:port</i> • For DCC combined with Resource Webgate: Leave empty See Also: " Configuring the PasswordPolicyValidationScheme "
Authentication Scheme, Challenge URL	Enter the Credential Collector login form relative URI: <ul style="list-style-type: none"> • For ECC: /pages/login.jsp See Also: " Configuring the PasswordPolicyValidationScheme "	Enter the Credential Collector login form relative URI: <ul style="list-style-type: none"> • For DCC: /oamssso-bin/login.pl See Also: " Configuring the PasswordPolicyValidationScheme "
Authentication Scheme, Challenge Parameters	ECC: User-defined Challenge Parameters: <p>OverrideRetryLimit=0 initial_command=NONE</p> See Also: <ul style="list-style-type: none"> • Table 22-23 • "Configuring the PasswordPolicyValidationScheme" 	DCC: User-defined Challenge Parameters: <ul style="list-style-type: none"> • creds • extracreds • MaxPostDataBytes • DCCctxCookieMaxLength • TempStateMode See Also: <ul style="list-style-type: none"> • Table 22-23 • "Configuring the PasswordPolicyValidationScheme"
Server Error Mode	Same for both DCC and ECC. See: " Setting the Error Message Mode for Password Policy Messages "	Same for both DCC and ECC. See: " Setting the Error Message Mode for Password Policy Messages "

Table 24-3 (Cont.) Specifying Credential Collectors and Related Forms for Authentication

In the . . .	For the ECC . . .	For the DCC . . .
Authentication Policy	<p>Credential collectors in authentication policies:</p> <ul style="list-style-type: none"> ECC: Use any authentication scheme configured for the ECC in the application domain for the protecting Webgate (Resource Webgate) <p>See Also: "Adding Your PasswordPolicyValidationScheme to ECC Authentication Policy"</p>	<p>Credential collectors in Authentication Policies:</p> <p>DCC Separate from Resource Webgate:</p> <p>***Protecting (Resource) Webgate Application Domain, (Authentication Policy protecting resources), use the DCC-related Authentication Scheme.</p> <p>***DCC Webgate Application Domain, Authentication Policy protecting resources, use the DCC-related Authentication Scheme. Consider:</p> <p>--With No Action URL: DCC uses the default /oam/server/auth_cred_submit, which is automatically protected with the DCC-related authentication scheme.</p> <p>--With an Action URL: Explicitly protect the specified Action URL with the DCC Scheme.</p> <p>See Also: "Adding PasswordPolicyValidationScheme to Authentication Policy for DCC"</p>

Table 24-3 (Cont.) Specifying Credential Collectors and Related Forms for Authentication

In the . . .	For the ECC . . .	For the DCC . . .
Logout Configuration	<p>ECC:</p> <p>In the protecting (Resource) Webgate Agent registration, configure the Logout URL as shown in Table 15-3</p> <p>See "Configuring Centralized Logout for 11g WebGates"</p>	<p>DCC:</p> <ul style="list-style-type: none"> In the DCC Agent registration page the Logout Redirect URL is ignored. In the protecting (Resource) Webgate registration, define the: <ul style="list-style-type: none"> Logout Redirect URL: <pre>http://dcchost:port/oamsso-bin/logout.pl</pre> <p>Note: If the Resource Webgate's Logout Redirect URL is anything other than <code>logout.*</code>, then that URL must be defined in the Logout URL parameter of the DCC Webgate registration. For example:</p> <p>If Resource Webgate registration has:</p> <pre>Logout Redirect URL http://dcchost:port/someurl.html</pre> <p>then DCC Webgate registration must have:</p> <pre>Logout URL: someurl.html</pre> <ul style="list-style-type: none"> DCC: Perl path must be updated in Oracle-provided scripts. <p>See "Configuring Logout When Using Detached Credential Collector-Enabled WebGate"</p>

24.5 Oracle-Provided Password Forms

Access Manager provides several pages for user interactions during credential collection. The location can be customized, depending on the desired topology of the authentication scheme being developed.

The Credential Collectors password pages are described in [Table 24-4](#).

Table 24-4 Credential Collector Password Pages

Credential Collector	Description
ECC pages	<p>The default embedded credential collector jsp forms, by default, reside on the OAM Servers.</p> <ul style="list-style-type: none"> Login page: <code>/pages/login.jsp</code> Logout page: <code>/pages/logout.jsp</code> Error page: <code>/pages/servererror.jsp</code> Multi-step authentication page: <code>/pages/mfa.jsp</code>

Table 24-4 (Cont.) Credential Collector Password Pages

Credential Collector	Description
DCC pages	<p>Dynamic pages general login/logout and password policy with the DCC are excluded automatically through the OHS httpd.conf/webgate.conf file--you do not need to configure a policy to exclude these. See the Webgate host:</p> <ul style="list-style-type: none"> • <code>\$WEBGATE_HOME/webgate/ohs/oamssso/*</code> • <code>\$WEBGATE_HOME/webgate/ohs/oamssso-bin/*pl</code> (update the Perl location in the first line of the login, logout, and securid scripts) • <code>\$WEBGATE_HOME/webgate/ohs/oamssso-bin/templates/*</code> <p>See Also:</p> <p>For details about customizing pages and messages, see the <i>Oracle Fusion Middleware Developer's Guide for Oracle Access Management</i>.</p>

Table 24-5 shows the password forms provided. The default pages can be customized for your enterprise, or replaced entirely with custom pages. For example, you can design, implement, and deploy a custom page that displays a different version of the login form for a mobile browser than is used for a desktop browser.

Table 24-5 Password Management Forms and Functions

Form	Function
Sign In Form	<p>The standard login form provides fields for userID and password. Clicking the Login button initiates authentication processing governed by the configured authentication module.</p> <p>See: <i>Oracle Fusion Middleware Developer's Guide for Oracle Access Management</i> for details about customizing login forms.</p>
Sign In Error	<p>This standard login form appears when an error occurs. The text in red identifies the errors, which can be suppressed or displayed.</p>

The screenshot shows a web form titled "Sign In". Below the title, it says "Enter your single sign on userid and password." There is a red error message: "An incorrect Username or Password was specified javax.naming.AuthenticationException: [LDAP: error code 49 - Invalid Credentials]". Below the error message are two input fields: "User ID" and "Password". At the bottom of the form is a "Sign In" button.

See: *Oracle Fusion Middleware Developer's Guide for Oracle Access Management* for details about suppressing or displaying.

Table 24-5 (Cont.) Password Management Forms and Functions

Form	Function
Password Expiry Notification	<p>The following message appears to inform the user that her password will expire, based on the notification policy.</p> 
Change Password Form	<p>Based on password expiration policy configuration, the following window appears to enforce the policy and require user to change his password.</p> 
Password Change Success	<p>The following message appears to confirm the password change was successful.</p> 

Table 24-5 (Cont.) Password Management Forms and Functions

Form	Function
Locked or Disabled User Account	Based on the password policy, user account lockout occurs when supplied credentials fail during the maximum allowed login attempts.

Sign In Error

The user account is locked or disabled. Please contact the System Administrator.

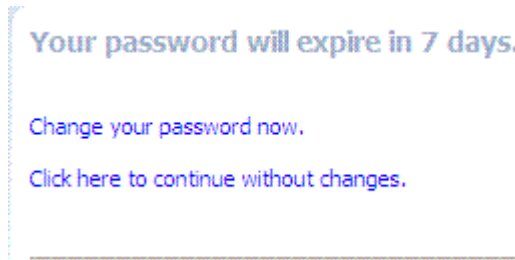
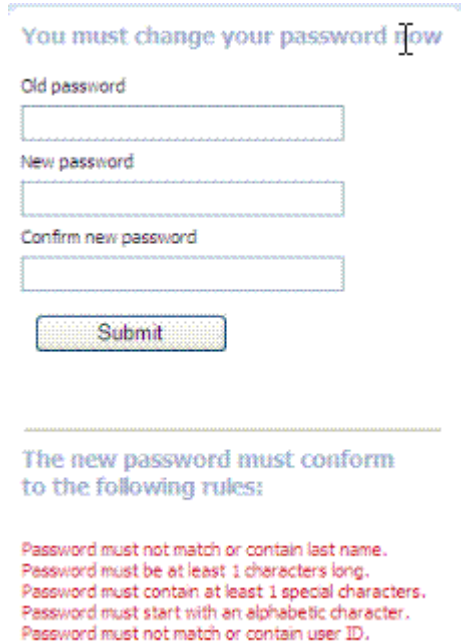
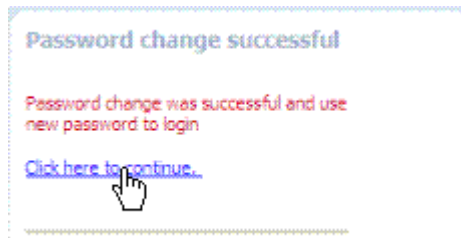
24.6 Managing Global Password Policy

Regardless of whether you choose the ECC or DCC, you can configure a global password policy that applies to all Access Manager-protected resources.

Authentication involves determining which credentials a user must supply when requesting access to a resource, gathering credentials, and returning a response that is based on the results of credential validation. Access Manager authentication processing relies on an authentication module (or plug-in) to define the rules governing requirements and transmission of information to the back-end authentication scheme. By default, Access Manager supports using the OAM Server Embedded Credential Collector (ECC) for authentication processing. However, you can also configure an 11g WebGate to use as an detached credential collector (DCC) instead.

Note:

Both the ECC and DCC facilitate multi-step authentication flows where credentials are not provided all at once. This increases the flexibility of interaction with users or programmatic entities for the purpose of collecting authentication-related information. For more information, see [Orchestrating Multi-Step Authentication with Plug-in Based Modules](#).

The following overview provides links to topics that describe how to configure and use the password policy. Unless explicitly stated, all tasks apply equally to the ECC and DCC. Skip any tasks that do not apply to your deployment.

Password policy management includes

1. [Defining Your Global Password Policy](#)
2. [Adding Key Password Attributes to the Default Store](#)
3. [Adding an Administrator to Change User Attributes After a Password Change](#)
4. [Configuring Password Policy Authentication](#)
5. [DCC: Configuring 11g WebGate and Authentication Policy for DCC](#)
6. [Completing Password Policy Configuration](#)
7. [Testing Your Multi-Step Authentication](#)

24.6.1 Defining Your Global Password Policy

Users with Oracle Access Management Administrator credentials can define a common password policy based on enterprise-defined requirements.

Note:

The only difference between a global password policy for the ECC versus the DCC is `Password Service URL`, which is credential collector-specific and defaults to ECC pages as shown in Step 2.

The specifications in this example are for illustration only. Your environment will be different.

1. In the Oracle Access Management Console, click **Application Security** at the top of the window.
2. In the Application Security console, click **Password Policy**.
3. On the Password Policy page, enter the Password Service URL for the desired credential collector login page (ECC or DCC, [Table 24-3](#)).

ECC Password Service URL	DCC Password Service URL
/pages/login.jsp	/oamssso-bin/login.pl

4. On the Password Policy page, enter values ([Table 24-2](#)) based on requirements for your enterprise. For example:
 - Warn After 3
 - Expire After 20
 - Permanent Lockout (Disable)
 - Lockout duration 1
 - Minimum Special Characters 1
5. Click **Apply** to submit the policy.
6. Proceed as needed for your environment; skip any tasks that have been completed already:
 - [Adding Key Password Attributes to the Default Store](#)
 - [Adding an Administrator to Change User Attributes After a Password Change](#)

24.6.2 Designating the Default Store for Your Password Policy

The Password Policy operates only with the designated Default Store. Administrator roles and credentials must reside in the System Store.

See Also:

["About using the System Store for User Identities"](#)

1. In the Oracle Access Management Console, click **Configuration** at the top of the window.
2. In the Configuration console, click **User Identity Stores**.
3. **Set the System Store:** Administrator roles and credentials must reside in this store.
 - a. Open the page of the store to designate as the System Store.
 - b. Check **Set as system store** (for domain wide authentication and authorization operations).
 - c. Click **Apply**.
 - d. **Add Administrators:** See "[Managing Administrator Roles](#)".
 - e. **Authentication Module:** Set the LDAP Authentication Module used by the `OAMAdminConsoleScheme` (authentication scheme) to use this System Store.
 - f. Configure one or more authentication plug-ins to use this store, as described in "[Orchestrating Multi-Step Authentication with Plug-in Based Modules](#)".
4. **Set Default Store:** This store is required for Password Policy, Security Token Service, and migration when patching.
 - a. Open the page of the store to designate as the Default Store.
 - b. Check the box beside Set as default store.
 - c. **Authentication Module:** Locate `OAMAdminConsoleScheme` and confirm that the LDAP module does not refer to this store. See "[Managing Native Authentication Modules](#)".
 - d. **Authorization Policy Conditions:** Choose the desired user identity store when setting Identity Conditions in Authorization Policies. See "[Defining Authorization Policy Conditions](#)".
 - e. **Token Issuance Policy Conditions:** Choose the desired user identity store when setting Identity Conditions in Token Issuance Policies. See "[Managing Token Issuance Policies, Conditions, and Rules](#)".
5. Close the registration page.

24.6.3 Adding Key Password Attributes to the Default Store

The Password Policy operates only with the designated Default Store.

This section provides steps for extending the default store schema for Oracle Access Management password policy operations.

- [LDIF Files and Key Password Attributes for Password Policy](#)
- [Extending the Default Store Schema with Password Policy Attributes](#)

24.6.3.1 LDIF Files and Key Password Attributes for Password Policy

The LDIF (Lightweight Directory Interchange Format) files distributed as part of Access Manager are meant to extend the schema with required object classes. Generally, these are applied using the Access Manager and Oracle Identity Management wiring has been performed manually. The user data object definition in the Access Manager schema is extended with attributes that enable password user status and password history maintenance. This definition is provided in an LDIF file, and must be added to each user identity store using the `ldapadd` tool.

Oracle-provided LDIFs are identified in [Table 24-6](#).

Note:

OAM_HOME contains installed files necessary to host Oracle Access Management. OAM_HOME resides within the directory structure of the Middleware home (\$MW_HOME).

Table 24-6 Location of Oracle-provided LDIFs for LDAP Providers

LDAP Provider	LDIF Location
OID: Oracle Internet Directory	<code>\$OAM_HOME/ oam/server/pswdservice/ldif/OID_PWDPersonSchema.ldif</code>
OVD: Oracle Virtual Directory	<code>\$OAM_HOME/ oam/server/pswdservice/ldif/OVD_PWDPersonSchema.ldif</code>
AD: Microsoft Active Directory	<code>\$OAM_HOME/ oam/server/pswdservice/ldif/AD_PWDPersonSchema.ldif</code>
SJS: sun Java System Directory	<code>\$OAM_HOME/ oam/server/pswdservice/ldif/ IPLANET_PWDPersonSchema.ldif</code>
eDirectory: Novell eDirectory	<code>\$OAM_HOME/ oam/server/pswdservice/ldif/EDIR_PWDPersonSchema.ldif</code>
ODSEE: Oracle Directory Server Enterprise Edition	<code>\$OAM_HOME/ oam/server/pswdservice/ldif/ IPLANET_PWDPersonSchema.ldif</code>
ODU: Oracle Unified Directory	<code>\$OAM_HOME/ oam/server/pswdservice/ldif/ODU_PWDPersonSchema.ldif</code>
SLAPD: OpenLDAP Directory	<code>\$OAM_HOME/ oam/server/pswdservice/ldif/OLDAP_PWDPersonSchema.ldif</code>

Table 24-6 (Cont.) Location of Oracle-provided LDIFs for LDAP Providers

LDAP Provider	LDIF Location
IBM: OBM Tivoli Directory	\$OAM_HOME/ oam/server/pswdservice/ldif/ TIVOLI_PWDPersonSchema.ldif

The attributes that enable password user status and password history maintenance are shown in [Table 24-7](#). The user data object of each user identity store must include the attributes shown in [Table 24-7](#). These can be added with the `ldapadd` tool, LDIF (Lightweight Directory Interchange Format) file.

Table 24-7 Key Password Attributes in a Password Policy

Attribute	Description	Format and Values
obPasswordCreationDate	The date and time used to calculate (at the time of user login) whether the password has expired and whether a warning needs to be issued.	YYYY-MM-DDThh:mm:ssZ
obPasswordHistory	Used to track the number of last passwords used. Access Manager understands 10g oblixPersonPwdPolicy format and changes it to new format.	New format: password1###password2## # Previous format: passwordX = SHA256 (password+canonical userid)
obPasswordChangeFlag	Used during forced password change for first time user login (or forced password change initiated by the Administrator).	Boolean string value. true false Empty string represents false.
obuseraccountcontrol	Used to represent a disabled user.	Non-encrypted string value. activated deactivated Empty string represents "activated".
obpasswordexpirydate	The time after which the user password is considered to be expired.	YYYY-MM-DDThh:mm:ssZ Empty value represents not expired.
obLockoutTime	The time up to which the user is considered to be locked out due to too many login attempts.	Epoch value (in seconds) representing time in the future. Seconds (since 01 January, 1970)
obLoginTrvCount	The number of consecutive login failures by the user. This counter is reset on the first correct password entry.	Non-encrypted integer value. 1, 2, 3, and so on.

Table 24-7 (Cont.) Key Password Attributes in a Password Policy

Attribute	Description	Format and Values
oblastsuccessfullogin	The time of the last successful login.	YYYY-MM-DDThh:mm:ssZ
oblastfailedlogin	The time of the last failed login.	YYYY-MM-DDThh:mm:ssZ

24.6.3.2 Extending the Default Store Schema with Password Policy Attributes

You can skip this task if the environment has been configured using `idmConfigTool -prepareIDStore`. If your user identity store has not been extended with the `oblix` schema, you must update the schema to include the object classes required by the password service. LDAP tools should be run from the `/bin` directory beneath `$OAM_HOME`.

The following procedure illustrates extending the Oracle Internet Directory schema. Your environment might be different.

1. Use the following command to update the Oracle Internet Directory object classes of the designated Default Store required by the password service:

```
ldapadd -D "cn=orcladmin" -w <password> -h <hostname> -p 3060 -x -f $OAM_HOME/oam/server/pswdservice/ldif/OID_PWDPersonSchema.ldif
```

2. Proceed to "[Adding an Administrator to Change User Attributes After a Password Change](#)".

24.6.4 Adding an Administrator to Change User Attributes After a Password Change

You can modify the Default Store (Oracle Internet Directory in this example) to use a different privileged account as the Bind DN. This enables sufficient privileges to change user attributes after a password change.

Prerequisites

Register a supported LDAP store and designate it as the Default Store. Ensure that the user you add is defined within the Default Store.

See Also:

["Managing Administrator Roles"](#)

1. In the Oracle Access Management Console, click **Configuration** at the top of the window.
2. In the Configuration console, click **Administration**.
3. **Add a New Administrator:**
 - a. In the **Administration** page, click **Grant**.
 - b. In the dialog that appears, click **Search**.
 - c. Select the desired role from the **Roles** drop-down list and click **Add Selected** to grant it to the selected user.

- d. Click **Apply** to submit the changes.
4. Proceed with "[Configuring Password Policy Authentication](#)".

24.7 Configuring Password Policy Authentication

After preparing your password policy, Default Store, and Administrator, you can develop your authentication module and scheme.

- [Password Policy Validation Authentication Module](#)
- [Configuring the PasswordPolicyValidationScheme](#)
- [Adding Your PasswordPolicyValidationScheme to ECC Authentication Policy](#)—If you are using the DCC, skip this topic and go to "[Configuring 11g WebGate and Authentication Policy for DCC](#)"
- [Supporting DCC Authentication Schemes with Pre-Authentication Rules](#)

24.7.1 Password Policy Validation Authentication Module

You must also configure the Password Policy Validation Authentication Module to use the Default Store.

Note:

There are no credential collector dependencies when defining the Password Policy Validation Module for authentication.

A sample module is shown in [Figure 24-2](#). The User Password Status Step is the unique step that relies on the `UserPasswordPolicyPlugin`.

Note:

`UserPasswordPolicyPlugin` is supported only when using LDAP based authentication modules. It does not work with non LDAP authentication modules.

Figure 24-2 Password Policy Validation Authentication Module with Orchestrated Plug-ins

Authentication Module Authentication Module Duplicate Apply

Custom Authentication Module relies on bundled plug-ins (or those that are developed using the Access Manager Authentication Extensibility Java API). This module uses more than one plug-in that you can orchestrate to ensure that each one performs a specific authentication function.

General **Steps** Steps Orchestration

View + × Detach

Step Name	Description	Plug-in Name
User Identification Step		UserIdentificationPlugin
User Authentication Step		UserAuthenticationPlugin
User Password Status Step		UserPasswordPolicyPlugin

Step Details Save Cancel

Step Name User Identification Step

Description

Plug-in Name UserIdentificationPlugin

Plug-in Parameters

KEY_LDAP_FILTER

KEY_IDENTITY_STORE_REF

KEY_SEARCH_BASE_URL

Each step identifies the action provided by a specific named plug-in.

See Also:

["Orchestrating Multi-Step Authentication with Plug-in Based Modules "](#)

Figure 24-3 shows the orchestration of steps within the authentication module. For more information on modules and steps, see ["Pre-populated Plug-ins for Configuring Access Manager with Multi-Step Authentication"](#).

Figure 24-3 Step Orchestration for Password Policy Validation Module

Authentication Module Authentication Module Duplicate Apply

Custom Authentication Module relies on bundled plug-ins (or those that are developed using the Access Manager Authentication Extensibility Java API). This module uses more than one plug-in that you can orchestrate to ensure that each one performs a specific authentication function.

General Steps **Steps Orchestration**

You can specify the initial step

* Initial Step

Name	Description	On Success	On Failure	On Error
User Identification Step		User Authentication Step	failure	failure
User Authentication Step		User Password Status Step	User Password Status Step	failure
User Password Status Step		success	failure	failure

Table 24-8 describes the Password Policy Validation module step details that you specify.

Table 24-8 User Password Step Details

Step Name	Step Details	Description
User Identification Step	KEY_LDAP_FILTER	<p>Add the LDAP filter to the KEY_LDAP_FILTER attribute. Only standard LDAP attributes can be used when defining an LDAP search filter. For example:</p> <pre>(uid={KEY_USERNAME})</pre> <p>See Also: Table 25-15 and your vendor documentation for the exact syntax for your identity store</p>
User Identification Step	KEY_IDENTITY_STORE_REF	<p>The name of the registered Identity Store containing the module users. Default: The registered Default Store.</p>
User Identification Step	KEY_SEARCH_BASE_URL	<p>Base URL for user searches. For example: dc=us,dc=example,dc=com</p>
User Authentication Step	KEY_IDENTITY_STORE_REF	<p>The name of the registered Identity Store containing the module users. Default: The registered Default Store.</p>
User Authentication Step	KEY_PROP_AUTHN_EXCEPTION	<p>Enable or disable the propagation of LDAP errors. "KEY_PROP_AUTHN_EXCEPTION" needs to be set to TRUE when the Authentication module has "Password Policy Plugin" as the next step of plugin execution; for example, when the module has Authentication Plugin -> Password Plugin, change this parameter to TRUE.</p>
User Password Status Step	PLUGIN_EXECUTION_MODE	<p>The execution mode of plug-in. Depending upon the configuration, this plug-in can operate either alone or with other default plug-ins. Values are one of the following:</p> <ul style="list-style-type: none"> PSWDONLY: The most preferred configuration where only the password status is determined. The ID and authentication must be performed using the UserIdentification and UserAuthentication Plugins. AUTHWITHPSWD: Both authentication and password are performed using this plug-in. AUTHONLY: Only the user identification and authentication is performed using this plug-in <p>Default: PSWDONLY</p>

Table 24-8 (Cont.) User Password Step Details

Step Name	Step Details	Description
User Password Status Step	OBJECTCLASS_EXTENSION_SUPPORTED	The object classes "oblixpersonpwdpolicy" and "oblixorgperson" are required to be present in the OAM user's entry for successful execution of this plugin. If this parameter is FALSE, the plugin will not add these object classes. If this parameter is TRUE, the plugin will try to add these object classes to the user's entry if the current user's entry does not already have them present. Default: FALSE
User Password Status Step	KEY_IDENTITY_STORE_REF	The name of the registered Identity Store containing the module users. Default: The registered Default Store.
User Password Status Step	NEW_USERPSWD_BEHAVIOR	Configures retroactive behavior of the new-user password-policy. Values are either: <ul style="list-style-type: none"> FORCEPASSWORDCHANGE: Forces a password change. NOFORCEPASSWORDCHANGE: The password policy change does not affect user passwords that are already set. Default: NOFORCEPASSWORDCHANGE
User Password Status Step	POLICY_SCHEMA	Policy schema for password service. Currently only OAM10G is supported. Default: OAM10G
User Password Status Step	URL_ACTION	The type of servlet action needed for redirecting the user to the specific password page for expiry and warning pages. Values can be either: <ul style="list-style-type: none"> REDIRECT_POST REDIRECT_GET FORWARD Default: REDIRECT_POST
User Password Status Step	DISABLED_STATUS_SUPPORT	Specifies whether the disabled status is to be supported and acted upon in this password service. Valid values are either True or False. Default: TRUE

Prerequisites

Defining Your Global Password Policy

Note:

There are no credential collector dependencies when defining the Password Policy Validation Module. Enter the Default Store as the KEY_IDSTORE_REF for each of the three plug-ins (with an Error redirect on Failure).

1. In the Oracle Access Management Console, click **Application Security** at the top of the window.
2. In the Application Security console, click **Authentication Modules** in the **Plugins** section.
3. In the Authentication Modules page, click **Search**, then click **Password Policy Authentication Module**.
4. Select the **Steps** tab; for each of the three steps add the **Default Store** name in the field beside KEY_IDSTORE_REF (Save after each change). For example:
 - a. **User Identification Step**
KEY_IDSTORE_REF: *OID*
Save.
 - b. **User Authentication Step**
KEY_IDSTORE_REF: *OID*
Save.
 - c. **User Password Status Step**
KEY_IDSTORE_REF: *OID*
Save.
5. Click **Apply**.
6. Proceed to "[Configuring the PasswordPolicyValidationScheme](#)".

24.7.2 Configuring the PasswordPolicyValidationScheme

Users with Administrator credentials can configure the PasswordPolicyValidationScheme.

You can have multiple authentication schemes for use with the global password policy.

Note:

Differences between values for the ECC versus the DCC include ([Table 24-3](#)):

- Challenge Redirect URL: *Credential Collector host and port*
 - Challenge URL: *Credential Collector Pages*
 - Challenge Parameters: [Table 22-22](#)
-
-

Prerequisites

[Password Policy Validation Authentication Module](#)

See Also:

["Managing Authentication Schemes"](#)

1. In the Oracle Access Management Console, click **Application Security** at the top of the window.
2. In the Application Security console, click **Authentication Schemes** in the **Access Manager** section.
3. In the Search Authentication Schemes page, click **Search**, then click **PasswordPolicyValidationScheme**.
4. Set up the scheme for your environment. For example:
 - Authentication Level **2**
 - Default (*blank*)
 - Challenge Method: **Form**
 - Challenge Redirect URL: **http://CredCollector_host:port/**
 - Authentication Module: **Password Policy Validation Module**
 - Challenge URL: **/CredCollector_pages/**
 - Context Type: **External**
 - Challenge Parameters:

ECC Challenge Parameters

```
OverrideRetryLimit=
0
initial_command=NON
E
```

DCC Challenge Parameters

```
OverrideRetryLimit=0
creds=userid password
```

See Also: [Table 22-23](#)

action If not specified, the default for both ECC and DCC is /oam/server/auth_cred_submit.

DCCctxCookieMaxLength (default is 4096)

TempStateMode controls how the DCC stores the OAM Server state: cookie or form (the default) as specified with the parameter's value.

MaxPostDataBytes Restricts the maximum number of bytes of POST data submitted as user credentials.

creds Whatever is passed must be specified in the obMap credentials parameter of the ObUserSession object, as described in the *Oracle Fusion Middleware Developer's Guide for Oracle Access Management*

5. Click **Apply**.
6. Proceed to "[Adding Your PasswordPolicyValidationScheme to ECC Authentication Policy](#)".

24.7.3 Adding Your PasswordPolicyValidationScheme to ECC Authentication Policy

A user with Administrative privileges can use the PasswordPolicyValidationScheme configured for the ECC in the application domain of the protecting Webgate (Resource Webgate).

Prerequisites

[Configuring the PasswordPolicyValidationScheme](#)

1. **ECC:** In the console, search for and open the appropriate Application Domain. (See "[Searching for an Existing Application Domain](#)").

See Also:

["Adding Your PasswordPolicyValidationScheme to ECC Authentication Policy"](#)

2. **ECC: Protect Resources using the PasswordPolicyValidationScheme:**
 - a. Find and open your **Protected Resource Policy** on the Authentication Policies tab (see "[Viewing or Editing an Authentication Policy](#)"):
 - Authentication Policies
 - Protected Resource Policy
 - b. Select **PasswordPolicyValidationScheme** for the **Protected Resource Policy** (Authentication Scheme) and click **Apply**.
 - c. Finish updating your Authentication and Authorization policies, as desired ([Managing Policies to Protect Resources and Enable SSO](#)).
3. Proceed as needed for your environment:
 - **ECC:** [Completing Password Policy Configuration](#)
 - **DCC:** [Configuring 11g WebGate and Authentication Policy for DCC](#)

24.7.4 Supporting DCC Authentication Schemes with Pre-Authentication Rules

When DCC authentication schemes are used, pre-authentication rules are unable to distinguish between internal and external URLs from different proxies. You have to create a new pre-authentication rule using *returnHost* parameter to support DCC authentication schemes.

Pre-authentication rules allow you to define a policy that can either block access to the user or allow OAM to use a different authentication scheme based on certain conditions.

The *host* parameter in the request data allows pre-authentication rules to be executed against the host name of a protected resource. When the request is originating from a DCC WebGate, the *host* parameter is unable to distinguish between internal and external URLs from different proxies. If you want the DCC WebGate to work with the proxy, you have to create a new pre-authentication rule as follows:

```
request.returnHost.lower().find('<proxy_host_name>')>0
```

The *returnHost* parameter has the proxy host name for internal and external URLs irrespective of whether the request is originated from a ECC or DCC WebGate. When you access the resource through the specified proxy, the authentication scheme is switched as specified in the new pre-authentication rule. In case of other configured proxy, the original authentication scheme specified in the **Authentication Policy** tab is retained.

24.8 Completing Password Policy Configuration

Administrators can set error mode for password policy messages, override native LDAP password policy validation, and perform evaluations to confirm the deployment is working as required.

These tasks are the same regardless of the credential collector you have configured. Perform the following tasks to complete your password policy configuration:

- [Setting the Error Message Mode for Password Policy Messages](#)
- [Overriding Native LDAP Password Policy Validation](#)
- [Disabling ECC Operation and Using DCC Exclusively](#)
- [Testing Your Multi-Step Authentication](#)

24.8.1 Setting the Error Message Mode for Password Policy Messages

Users with administrative privileges can set the Server Error Mode for password policy messages.

[Figure 24-4](#) shows the Access Manager settings.

Figure 24-4 Server Error Mode for Password Management

Access Manager Settings
The following settings apply to the Access Manager service.

▲ Load Balancing

* OAM Server Host * OAM Server Protocol

* OAM Server Port * Server Error Mode

Prerequisites

- [Managing Global Password Policy](#)
- [Configuring Password Policy Authentication](#)
- Optional: [Configuring 11g WebGate and Authentication Policy for DCC](#)

1. In the Oracle Access Management Console, click **Configuration** at the top of the window.
2. In the Configuration console, select **Access Manager** from the **Settings** drop-down list.
3. In the **Load Balancing** section, set the **Server Error Mode** to **Internal**.
4. Click **Apply**.
5. Proceed with "[Overriding Native LDAP Password Policy Validation](#)".

24.8.2 Overriding Native LDAP Password Policy Validation

You need to disable native LDAP password policy validation before the non-native password policy can be used.

For example, with Oracle Internet Directory registered for Oracle Access Management, native password policy is generally located as follows:

```
dn:
cn=default,cn=pwdPolicies,cn=Common,cn=Products,cn=OracleContext,<DOMAIN_CONTAINER>
```

Caution:

Disabling the native LDAP password policy validation leaves no enforcement for direct LDAP operations. There are various password policies in Oracle Internet Directory, including one in the following:

```
dn: cn=default,cn=pwdPolicies,cn=Common,cn=Products,cn=OracleContext
```

However, this might not apply to your domain.

You can disable the Oracle Internet Directory password policy by setting the `orclpwdpolicyenable` parameter to zero (0).

See Also:

The various attributes described in

The following procedure is only an example. Your environment will be different.

Prerequisites

[Setting the Error Message Mode for Password Policy Messages](#)

1. Refer to the manual from your LDAP directory vendor.
2. **Oracle Internet Directory:** Disable native policy by setting `orclpwdpolicyenable` to zero (0).
 - Confirm the location of the password policy for your domain.
 - When you are sure you have the proper native LDAP policy, disable the policy. For example:

```
orclpwdpolicyenable = 0
```
3. Proceed as follows, depending on your deployment:
 - ["Disabling ECC Operation and Using DCC Exclusively"](#)
 - ["Testing Your Multi-Step Authentication"](#)
 - [Configuring Centralized Logout for Sessions Involving 11g WebGates: "Configuring Logout When Using Detached Credential Collector-Enabled WebGate"](#)

24.8.3 Disabling ECC Operation and Using DCC Exclusively

You can skip this task to allow the DCC and ECC to co-exist, and maintain authentication schemes and policies for both credential collectors. To disable ECC, you must edit the `oam-config.xml` file. Generally, Oracle recommends not editing `oam-config.xml`. Changes to this file could result in lost data or overwriting of the file during data sync operations. However, there is no other way to disable the ECC completely in favor of the DCC.

Note:

After disabling the ECC, access to resources protected by schemes and policies that rely on the ECC will be prohibited, including access to the Oracle Access Management Console.

Prerequisites

[Configuring 11g WebGate and Authentication Policy for DCC](#)

1. Make your changes on the node running the AdminServer to minimize possible conflicts that another AdminConsole user might make.
2. Back up oam-config.xml in $\$DOMAIN_HOME/config/fmwconfig/$ and store the copy in a different location for use later if needed.
3. Locate the ECCEnabled parameter in the OAMServicesDescriptor section and make the changes shown here in bold:

```
<Setting Name="OAMServicesDescriptor" Type="htf:map">
  ... ..
  <Setting Name="ECCEnabled" Type="htf:map">
    <Setting Name="ServiceStatus" Type="xsd:boolean">false</Setting>
  </Setting>
```

4. Increment by 1, the configuration version number at the top of the file to associate your change and enable automatic propagation and dynamic activation across all running OAM Servers (see the next to last line of this example):

```
<Setting Name="Version" Type="xsd:integer">
  <Setting xmlns="http://www.w3.org/2001/XMLSchema"
    Name="NGAMConfiguration" Type="htf:map">
    <Setting Name="ProductRelease" Type="xsd:string">11.1.1.3</Setting>
    <Setting Name="Version" Type="xsd:integer">2</Setting>
  </Setting>
```

5. Proceed to "[Testing Your Multi-Step Authentication](#)".

24.8.4 Testing Your Multi-Step Authentication

You can perform a number of evaluations to confirm that your deployment is working properly.

See Also:

[Configuring Centralized Logout for Sessions Involving 11g WebGates](#)

1. Confirm access after login:
 - a. Open a new browser and request a resource.
 - b. Log in with your user credentials.
 - c. Confirm that you have access to the resource.
2. Confirm no access on incorrect login:

- a. Open a new browser and request a resource.
 - b. Log in with incorrect user credentials.
 - c. Confirm that you must re-authenticate.
3. Confirm lockout after exceeding maximum incorrect login attempts:
 - a. Open a new browser and request a resource.
 - b. Log in with incorrect user credentials repeatedly.
 - c. Confirm that the user account is locked.
 4. Modify and evaluate your password expiry policy:
 - a. Log in to the Oracle Access Management Console.
 - b. In your password policy, reset the expiry and lockout periods ([Table 24-2](#)) so that you will see warnings on your next login.
 - c. Save the policy updates.
 - d. Open a new browser and request a resource.
 - e. Verify the warning page appears advising that the password will expire.
 - f. Click the link to continue without password change.
 5. Change your password:
 - a. Open a new browser and request a resource.
 - b. On the password expiry warning page, click the link to change your password.
 - c. On the password change page, enter your correct old password.
 - d. In the new password field, enter a different new password that does not follow the password policy and confirm the password validation error.
 - e. Enter a new password that meets requirements and confirm success and access to the resource.

24.9 Configuring the IPFUserPasswordPolicyPlugin

The Identity Password Framework (IPF) password policy plugin handles the password related flows during login. Configuring the IPF password policy plugin is the most critical step in making sure that OAM and OIM LDAP applications can work in tandem.

Using the IPF password plugin in OAM makes sure that password features act across both OAM and OIM in similar ways. This section contains the following information:

- [Enabling the IPF Password Service](#)
- [Configuring Password Policy for IPF Password Service](#)
- [Extending the LDAP Definitions](#)
- [Configuring the Password Policy Validation Authentication Module and Scheme](#)

- [Setting Up the Forgot Password Module](#)

24.9.1 Enabling the IPF Password Service

The IPF password service can be enabled in a newly installed (not upgraded) environment by manually editing `oam-config.xml`.

Edit `oam-config.xml` and add the following line:

```
<Setting Name="pswdServiceDataVersion" Type="xsd:string">3</Setting>
```

This procedure assumes:

- The WebLogic Server, Oracle Internet Directory, Oracle HTTP Server and a database are installed.
 - Oracle Access Management is installed in DB mode and configured to use OID as a user store.
 - WebGate 11g is installed and configured against the policy server.
 - The exact mechanism of extending LDAP directory for each directory type.
1. Shut down the entire domain including the WebLogic Admin Server and all OAM Managed Servers.
 2. Locate the correct `oam-config.xml` file in `<DOMAIN_HOME>/config/fmwconfig/` and make a backup of it before editing.
 3. Modify the file so it contains the following snippet.

```
<Setting Name="PasswordService" Type="htf:map">  
  <Setting Name="pswdServiceDataVersion" Type="xsd:string">3</  
Setting>  
  <Setting Name="pswdServiceUrl" Type="xsd:string">/oam/pages/pswd.jsp</Setting>  
</Setting>
```

Be sure to increment the version number of the file by 1 to ensure that the changes are not overwritten by the Oracle Access Management Console.

4. Save the file.
5. Restart the WebLogic Admin Server.
6. Restart the OAM Managed Servers.

As a verification step, check `<DOMAIN_HOME>/config/fmwconfig/oam-config.xml` on each of the OAM Managed Server nodes to ensure that the updated version has propagated correctly.

24.9.2 Configuring Password Policy for IPF Password Service

Note that the password policy in OAM should be in sync with that of OAM LDAP to work consistently between both products.

See [Accessing Password Policy Configuration Page](#) for details. It is up to the administrator to ensure that the policies are indeed the same and consistent.

24.9.3 Extending the LDAP Definitions

Depending on the type of the directory, add the required objectclass schema definitions so that the LDAP directory can use these to extend the user objectclass. The appropriate schema files are located in \$IDM_HOME/modules/oracle.idm.ipf_11.1.2/scripts/ldap.

[Table 24-9](#) documents the LDIF file to use with supported LDAP directories.

Table 24-9 Included LDIF Schema Files

LDAP Directory	LDIF Schema File
OID	OID_OblixSchema.ldif, OID_OracleSchema.ldif
AD	AD_OblixSchema.ldif, AD_OracleSchema.ldif
OUD	OUD_OblixSchema.ldif, OUD_OracleSchema.ldif
ODSEE	IPLANET_OblixSchema.ldif, IPLANET_OracleSchema.ldif
OPENLDAP	OLDAP_OblixSchema.schema, OLDAP_OracleSchema.schema
OVD	OVD_OblixSchema.ldif, OVD_OracleSchema.ldif
Tivoli	TIVOLI_OblixSchema.ldif, TIVOLI_OracleSchema.ldif
EDIR	EDIR_OblixSchema.ldif, EDIR_OracleSchema.ldif

24.9.4 Configuring the Password Policy Validation Authentication Module and Scheme

The Password Policy Validation Authentication Module needs to be configured to use the required identity store, as well as some of the operations configuration as per installation requirements.

There are no credential collector dependencies when defining the Password Policy Validation Module for authentication. The User Password Status Step is the unique step that relies on the IPFUserPasswordPolicyPlugin. See "[Password Policy Validation Authentication Module](#)" and [Configuring the PasswordPolicyValidationScheme](#)

24.9.5 Setting Up the Forgot Password Module

If the forgot password feature needs to be enabled in OAM, the IPFForgotPasswordModule is used. The forgot password authentication enables OAM users to change their password by authenticating them using previously collected challenges.

The administrator can setup forgot password URL by following the procedure documented in [Administering the Forgot Password URL](#).

Managing Policies to Protect Resources and Enable SSO

Access Manager Application Domains and policies can be accessed and managed through the Oracle Access Management Console.

The following topics describe how to create and manage policies and identify the resources to be governed by these policies:

- [Prerequisites to Managing Policies and Protecting Resources](#)
- [Introduction to Application Domain and Policy Creation](#)
- [Understanding Application Domain and Policy Management](#)
- [Managing Application Domains Using the Console](#)
- [Adding and Managing Policy Resource Definitions](#)
- [Defining Authentication Policies for Specific Resources](#)
- [Defining Authorization Policies for Specific Resources](#)
- [Configuring Success and Failure URLs for Authorization Policies](#)
- [Introduction to Authorization Policy Rules and Conditions](#)
- [Defining Authorization Policy Conditions](#)
- [Defining Authorization Policy Rules](#)
- [Configuring Policy Ordering](#)
- [Introduction to Policy Responses for SSO](#)
- [Adding and Managing Policy Responses for SSO](#)
- [Validating Authentication and Authorization in an Application Domain](#)
- [Understanding Remote Policy and Application Domain Management](#)
- [Managing Policies and Application Domains Remotely](#)
- [Application and Application-types](#)

25.1 Prerequisites to Managing Policies and Protecting Resources

Before you proceed with policy management and resource protection ensure the system level requirements are met.

Following are the requirements to perform tasks in this chapter:

- OAM Server should be running.
- Users and groups who can access a protected resource should already be created in the User Identity Store associated with Oracle Access Management.
- Policy-enforcement Agents should be registered.
- Shared components for use in any Application Domain should be defined.

See Also:

- [Understanding Application Domain and Policy Management](#)
 - [Reviewing Bundled, Generated, and Migrated Artifacts](#)
 - [Introduction to Agents and Registration](#)
 - [Managing Authentication and Shared Policy Components](#)
-
-

25.2 Introduction to Application Domain and Policy Creation

Application domains are the top-level constructs of the Access Manager 11g policy model. Each Application Domain provides a logical container for resources or sets of resources, and the associated policies that dictate who can access specific protected resources.

Certain shared components are used within each Application Domain. Each Application Domain represents a singular application on a particular host or Administrators can define different Application Domains for resources that reside on the same Web server and are closely tied to each other in one way or another. For example, an Administrator can create a single Application Domain for a financial application and an accounts receivable application, or have a different Application Domain for each. Configurable policies allow or deny access to the resources.

Note:

To enhance security, Access Manager, by default, will deny access when a resource is not protected by a policy that explicitly allows access.

Each Access Manager Application Domain contains information regarding:

- **Resource Definitions**
Each resource definition in an Application Domain requires a Resource Type, Host Identifier (for HTTP resources), and a URL to the specific resource. You can have as many resource definitions as you need in an Application Domain.
- **Authentication Policies and Responses for Specific Resources**
Each authentication policy includes a unique name, one authentication scheme, success and failure URLs, one or more resources to which this policy applies, and Administrator-defined responses to be applied after successful authentication.

Note:

Depending on the policy responses specified for authentication or authorization success and failure, the end user might be redirected to a specific URL, or user information might be passed to other applications through a header variable or a cookie value.

- **Authorization Policies, Conditions, Rules, and Responses for Specific Resources**
Each authorization policy includes a unique name, success and failure URLs, and one or more resources to which this policy applies. In addition, Administrators can define specific conditions that must be fulfilled for a successful authorization and define responses to be applied after successful authorization.
- **Token Issuance Policies, Conditions, and Rules for Specific Resources**
A Token Issuance Policy defines the rules under which the Security Token Service can issue a token for a resource (Relying Party Partner) based on the client's identity, with the client either being a Requester Partner or an end user.
- **Policy Ordering**
Policy ordering is a new feature in which the administrator manually designates the order in which policies within an application domain will be matched to incoming requests for access to protected resources. Previous versions of Access Manager used the best match algorithm for this purpose.

When a new application is placed behind an existing agent, the Administrator must decide if the application should be protected by a separate (new) Application Domain and policies or an existing Application Domain and policies. This section provides information in the following sections to inform your choice.

- [About Generating Application Domains and Policies Automatically](#)
- [About Managing Application Domains and Policies Remotely](#)
- [Creating or Managing an Application Domain and Policies](#)

25.2.1 About Generating Application Domains and Policies Automatically

When you register a policy-enforcement Agent with Access Manager, you can choose to have the domain and policies generated automatically or decline the automatic generation.

An automatically generated Application Domain is named for the Agent and seeded with default resources and basic policies (authentication and authorization). No Token Issuance Policy is defined, though an empty container is provided.

During Agent registration, it is presumed that the Agent resides on the same Web Server as the application it protects. However, the Agent can be on a proxy Web server and the application can be on a different host. Default resources are protected by basic policies until an Administrator adds more resources or modifies or adds policies.

Note:

IAMSuiteAgent is a pre-registered Java Agent filter that provides an Application Domain (IAMSuite) to protect the Oracle Fusion Middleware console and other consoles. For more information, see "[Bundled 10g IAMSuiteAgent Artifacts](#)".

25.2.2 About Managing Application Domains and Policies Remotely

Access Manager provides two modes to manage Application Domains and their policies without registering or modifying the companion agent.

Remote policy and Application Domain management supports only create and update functions. Remote management does not support removing Application Domains or policies. For more information, see "[Understanding Remote Policy and Application Domain Management](#)".

25.2.3 Creating or Managing an Application Domain and Policies

Here is an overview that outlines the procedures that must be performed to manually create or manage an Application Domain and policies.

To create or manage an Application Domain:

1. Get acquainted with the following details:
 - [Understanding Single Sign-On with Access Manager](#)
 - [Managing Authentication and Shared Policy Components](#)
 - [Understanding Application Domain and Policy Management](#)
 - [Understanding Remote Policy and Application Domain Management](#)
2. Perform all prerequisite tasks for this chapter, as described in:
 - [Prerequisites to Managing Policies and Protecting Resources](#)
3. Start a fresh Application Domain (or view an existing one), as described in:
 - [Creating a New Application Domain](#)
 - [Viewing or Editing an Application Domain](#)
 - [Managing Policies and Application Domains Remotely](#)
4. Add resource definitions to your Application Domain as described in:
 - [Adding and Managing Policy Resource Definitions](#)
5. Define your Authentication Policy, as described in:
 - [Creating an Authentication Policy for Specific Resources](#)
 - [Adding and Managing Policy Responses for SSO](#)
6. Define your Authorization Policy, as described in:

- [Creating an Authorization Policy and Specific Resources](#)
 - [Adding and Managing Policy Responses for SSO](#)
 - [Defining Authorization Policy Conditions](#)
 - [Defining Authorization Policy Rules](#)
7. Define your Token Issuance Policy, as described in:
 - [Managing Templates, Endpoints, and Policies: Managing Token Issuance Policies and Conditions](#)
 - [Adding and Managing Policy Responses for SSO](#)
 - [Defining Authorization Policy Conditions](#)
 - [Defining Authorization Policy Rules](#)
 8. Configure SSO settings and policy evaluation caches, as described in:
 - [Configuring Access Manager Settings : "Managing SSO Tokens and IP Validation"](#)
 - [Configuring Access Manager Settings : Managing Run Time Policy Evaluation Caches](#)
 9. Validate your policies and configuration, as described in:
 - [Configuring Centralized Logout for Sessions Involving 11g WebGates: Validating Global Sign-On and Centralized Logout](#)

25.3 Understanding Application Domain and Policy Management

Whether you create an Application Domain manually or you accept automatic policy generation when registering an Agent, the elements of an Application Domain are the same. All policies and Application Domains are managed using the Oracle Access Management Console.

For details, see the following topics:

- [Application Domain Pages](#)
- [Application Domain Summary Page](#)
- [Application and Application-types](#)
- [Resource Container in an Application Domain](#)
- [Authentication Policy Pages](#)
- [Authorization Policy Pages](#)
- [Token Issuance Policy Pages](#)

25.3.1 Application Domain Pages

Regardless of the method you choose to create an Application Domain, a unique name is required to be used as an identifier. When you click Application Domains, a Search page is displayed. The Create Application Domain button in the upper-right corner

enables you to start a fresh domain definition. Otherwise, enter a name (or leave the Name field blank) and click the Search button to list existing Application Domains.

Figure 25-1 is the Application Domains Search page, controls, and the Search Results table with its own tool bar.

Figure 25-1 Application Domains Search Page

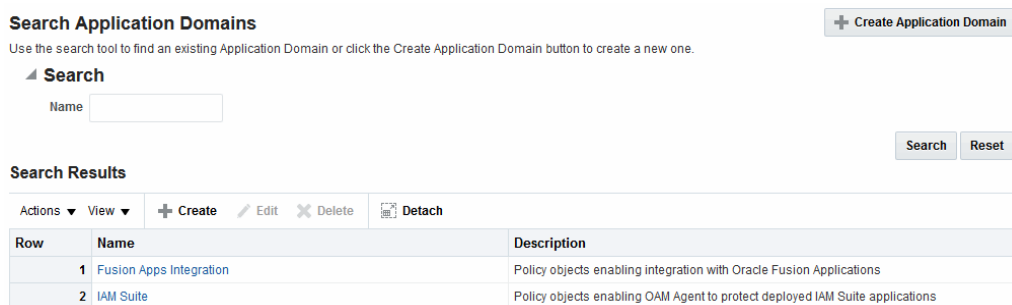

25.3.2 Application Domain Summary Page

When you click the name of an Application Domain in the Search results, the Name, an optional description and Policy Ordering configuration are displayed on the Summary tab.

Other information is organized in the following tabs.

- Resources
- Authentication Policies
- Authorization Policies
- Token Issuance Policies
- Administration

Figure 25-2 is a screenshot of a typical Application Domain page. In a generated Application Domain, the Name and Description are populated as shown. When you create an Application Domain manually, the Description is entered by the Administrator.

Figure 25-2 Example Application Domain Summary Page

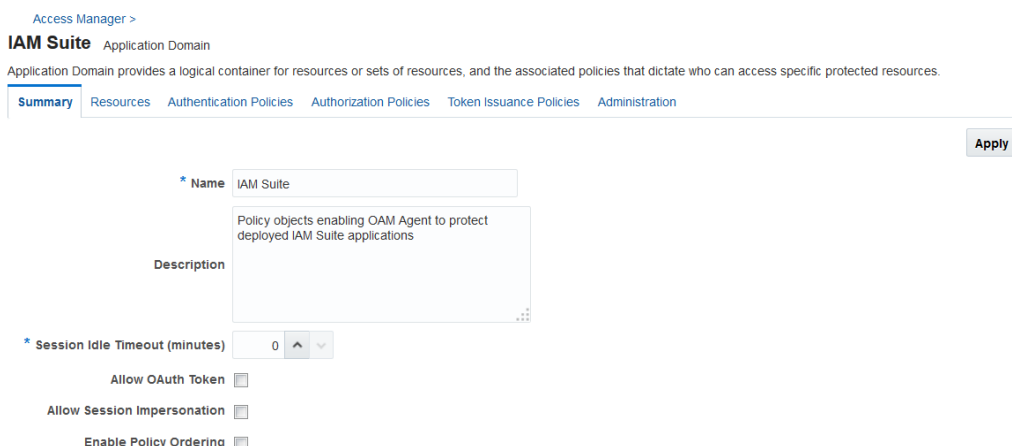

25.3.3 Resource Container in an Application Domain

The Resources tab in the Application Domain represents the container for all resource definitions in that domain. When the Resources tab is clicked and displayed, the Search controls are available to help you find specific definitions quickly.

Figure 25-3 illustrates Search controls that you can use to refine your resource definition search. There is also a New Resource button in the upper-right corner. The Search Results table provides key information about each definition found.

Figure 25-3 Search Results for Resources in an Application Domain

IAM Suite Application Domain

Application Domain provides a logical container for resources or sets of resources, and the associated policies that dictate who can access specific protected resources.

Summary **Resources** Authentication Policies Authorization Policies Token Issuance Policies Administration

Use the search tool to find an existing Resource or click the New Resource button to create a new one.

Search

Resource Type: HTTP (dropdown) Query String:

Host Identifier: Authentication Policy: (dropdown)

Resource URL: Authorization Policy: (dropdown)

Search Results

Actions: View (dropdown)

Row	Resource Type	Host Identifier	Resource URL	Query String	Authentication Policy	Authorization Policy
1	HTTP	IAMSuiteAgent	/ucs/**			
2	HTTP	IAMSuiteAgent	/reqsvc/**			
3	HTTP	IAMSuiteAgent	/sts/**			
4	HTTP	IAMSuiteAgent	/oamfed/**			
5	HTTP	IAMSuiteAgent	/oam/serverfed/authn/sc...		LocalAuthnFederationFA...	Protected Resource Policy
6	HTTP	IAMSuiteAgent	/oam/serverfed/authn/sc...		LocalAuthnFederationLD...	Protected Resource Policy
7	HTTP	IAMSuiteAgent	/oam/serverfed/authn/sc...		LocalAuthnFederationBa...	Protected Resource Policy
8	HTTP	IAMSuiteAgent	/oam/serverfed/authn/sc...		LocalAuthnFederationBa...	Protected Resource Policy

The default Resource Type is HTTP; default Resource URL is /**. With HTTP resource definitions you can also search on a query string defined for that resource. The query string can be only the Base URL and can include optional pattern-matching special characters to represent a set of URLs. In this generated domain, the Host Identifier matches the name of the HTTP agent that was registered. Basic information about the policies is also provided.

See Also:

- ["Adding and Managing Policy Resource Definitions"](#)
- [Reviewing Bundled, Generated, and Migrated Artifacts](#)

25.3.4 Authentication Policy Pages

The Authentication Policies tab provides access to defined or generated policies with no search controls needed.

When an Administrator creates an Application Domain manually she must also manually create all policies. In a generated Application Domain, two Authentication policies are created automatically, as shown in Figure 25-5:

- Authentication Policy: Protected Resource Policy
- Authentication Policy: Public Resource Policy

Figure 25-4 Authentication Policies Tab

IAM Suite Application Domain

Application Domain provides a logical container for resources or sets of resources, and the associated policies that dictate who can access specific protected resources.

Summary Resources **Authentication Policies** Authorization Policies Token Issuance Policies Administration

Select an existing Authentication Policy from the list or click the Create Authentication Policy button to create a new one.

Actions View **+** Create Duplicate Edit Delete Detach

Row	Name	Description
1	LocalAuthnFederationFAAuthScheme	Policy Component created for Local Authentication in IdP mode - Do not modify
2	LocalAuthnFederationLDAPScheme	Policy Component created for Local Authentication in IdP mode - Do not modify
3	LocalAuthnFederationBasicFAScheme	Policy Component created for Local Authentication in IdP mode - Do not modify
4	LocalAuthnFederationBasicScheme	Policy Component created for Local Authentication in IdP mode - Do not modify
5	ESSOAuthnPolicy	Authentication policy for ESSO resources

Authentication policies are local, which means that each policy applies only to the resources specified for the policy. Each resource can be protected by only a single authentication policy.

Figure 25-5 shows the Protected Resource Policy and the columns of information displayed automatically on the policy's Resources tab. The Responses tab is available.

Figure 25-5 Authentication Policy Page: Resources and Responses

ESSOAuthnPolicy Authentication Policy Duplicate Apply

Authentication Policy defines the type of verification that must be performed to provide a sufficient level of trust for Access Manager to grant access to the user making the request. A single policy can be defined to protect one or more resources in the Application Domain.

Name: ESSOAuthnPolicy Success URL:

Description: Authentication policy for ESSO resources Failure URL:

Authentication Scheme: OAMLDAPPluginAuthnScheme

Resources Responses Advanced Rules

Resource Type	Host Identifier	Resource URL	Query String
HTTP	IAMSuiteAgent	/oamreauthenticate/**	
HTTP	IAMSuiteAgent	/logonmanager/**	
HTTP	IAMSuiteAgent	/daas/am/esso/**	
HTTP	IAMSuiteAgent	/wlm/**	

Note:

Initially, all resources are protected. Success and Failure URLs and Responses must be added manually; no default values are supplied.

A description is provided during automatic generation:

"Policy set during domain creation. Add resources to this policy to protect them."

This generated policy uses the LDAPScheme as the authentication scheme. However, the optional elements of the policy are not yet defined.

Protected Resources are identified on the Resources tab as *HostIdentifier/***.

Note:

Administrators can change the authentication scheme, specify Success and Failure URLs, add other resources, and define SSO Responses.

Public Resource Policy: A second authentication policy is also generated automatically. This policy uses AnonymousScheme as the default scheme for authentication, which allows anyone access.

Initially, this Public Resource Policy does not include or serve any Resources. The Description tells Administrators what is needed:

Policy set during domain creation. Add resources to this policy to allow anyone access.

See Also:

["Introduction to Policy Responses for SSO"](#)

25.3.5 Authorization Policy Pages

The Authorization Policies tab provides access to defined or generated policies with no search controls needed.

In a generated Application Domain, two Authorization policies are created automatically; however, each resource can be protected by only a single authorization policy:

- Protected Resource Policy
- Public Resource Policy

The Authorization Policy tab is shown in [Figure 25-7](#). From this tab, you can select a policy to edit or create a new policy.

Figure 25-6 Authorization Policies Page

IAM Suite Application Domain

Application Domain provides a logical container for resources or sets of resources, and the associated policies that dictate who can access specific protected resources.

Summary Resources Authentication Policies **Authorization Policies** Token Issuance Policies Administration

Select an existing Authorization Policy from the list or click the Create Authorization Policy button to create a new one.

Actions View Create Duplicate Edit Delete Detach

Row	Name	Description
1	ESSOReauthAuthzpolicy	Protected Authorization Policy for oamreauth
2	ESSOAuthzPolicy	Protected Authorization Policy for ESSO Resources
3	Protected Resource Policy	Protected Authorization Policy for OAMAgent
4	OICAuthorizationPolicy	Protected Authorization Policy for OIC Resources

The Authorization Policy page is shown [Figure 25-7](#). It provides several tabs where you can define the various components of this Authorization policy. Initially, all resources are protected and access is denied. Success and Failure URLs Conditions, Rules, and Responses must be added manually (no default are supplied).

Figure 25-7 Individual Authorization Policy Page

ESSOAuthzPolicy Authorization Policy Duplicate Apply

Authorization policy contains a set of conditions that define whether a user should be permitted or denied access to the resources protected by the policy. Authorization rules and conditions apply to all resources within a specific Authorization policy.

Summary Resources Conditions Rules Responses

* Name: ESSOAuthzPolicy

Description: Protected Authorization Policy for ESSO Resources

Success URL:

Failure URL:

The Authorization Policy Resources tab is shown in [Figure 25-8](#). You use this page to add (or remove) resources for this policy.

Figure 25-8 Individual Authorization Policy Resources tab

ESSOAuthzPolicy Authorization Policy Duplicate Apply

Authorization policy contains a set of conditions that define whether a user should be permitted or denied access to the resources protected by the policy. Authorization rules and conditions apply to all resources within a specific Authorization policy.

Summary Resources Conditions Rules Responses

Resources + Add X Delete					
Resource Type	Host Identifier	Resource URL	Query String	Name Value list	Operations
HTTP	IAMSuiteAgent	/logonmanager/**			All
HTTP	IAMSuiteAgent	/idaas/am/esso/**			All
HTTP	IAMSuiteAgent	/wlm/**			All

Administrators can also define Conditions, Rules, and Responses for this policy. None are generated automatically.

See Also:

- ["Introduction to Policy Responses for SSO"](#)
- ["Introduction to Authorization Policy Rules and Conditions"](#)

25.3.6 Token Issuance Policy Pages

By default, only a container for Token Issuance Policies is provided in a generated Application Domain. Any Resources, Conditions, Rules, and Responses must be added manually.

Figure 25-9 Token Issuance Policies Page

IAM Suite Application Domain

Application Domain provides a logical container for resources or sets of resources, and the associated policies that dictate who can access specific protected resources.

Summary Resources Authentication Policies Authorization Policies **Token Issuance Policies** Administration

Select a Token Issuance Policy from the list or click the Create Token Issuance Policy button to create a new one.

Actions View + Create Duplicate Edit Delete Detach

Row	Name	Description
No data to display.		

For specific information on this policy type, see:

- ["Managing TokenServiceRP Type Resources"](#)
- ["Managing Token Issuance Policies, Conditions, and Rules"](#)

25.4 Managing Application Domains Using the Console

Managing an Application Domain involves adding, modifying, or deleting general and resource-related settings and policies.

Each Application Domain must have a unique name that matches the agent name. After entering a name and optional description for the new Application Domain, click Apply to create it. This manual creation makes available the complete series of tabs: Summary, Resources, Authentication Policies, Authorization Policies, Token Issuance Policies.

Note:

If the Application Domain was created using remote registration or while registering an agent, basic policy information is generated with it. For details, see [Understanding Remote Policy and Application Domain Management](#) and [Managing Policies and Application Domains Remotely](#).

This section describes how to create and manage an Application Domain using the Oracle Access Management Console. It includes the following topics:

- [Creating a New Application Domain](#)
- [Searching for an Existing Application Domain](#)
- [Viewing or Editing an Application Domain](#)
- [Deleting an Application Domain and Its Contents](#)

25.4.1 Creating a New Application Domain

Users with valid Administrator credentials can manually create an Application Domain using the Oracle Access Management Console. Alternatively, Application Domains can be generated automatically during agent registration, as described in [Introduction to Agents and Registration](#) and [Registering and Managing OAM 11g Agents](#).

Decide whether you need a new Application Domain or if you can add resources to an existing Application Domain. You can protect multiple applications using the same Agent by manually creating one Application Domain and manually adding resources and policies.

Prerequisites

See [Prerequisites to Managing Policies and Protecting Resources](#) at the beginning of this chapter.

To create a new Application Domain

1. In the Oracle Access Management Console, click **Application Security** at the top of the window.
2. In the Application Security console, select **Create Application Domain** from the **Create (+)** menu in the Access Manager section.

3. On the Create Application Domains page, add a unique name, an optional description and other details, then click **Apply** and close the Confirmation window.

See [Configuring Policy Ordering](#).

4. View and manage the following containers (tabs) within the Application Domain container:
 - **Resources:** See "[Adding and Managing Policy Resource Definitions](#)".
 - **Authentication Policies:** See "[Defining Authentication Policies for Specific Resources](#)".
 - **Authorization Policies:** See "[Defining Authorization Policies for Specific Resources](#)".
 - **Token Issuance Policies:** See "[Managing Token Issuance Policies, Conditions, and Rules](#)".

25.4.2 Searching for an Existing Application Domain

Users with valid Administrator credentials can to search for a specific Application Domain.

Note:

This Search operation is case sensitive.

To search for an Application Domain

1. In the Oracle Access Management Console, click **Application Security** at the top of the window.
2. In the Application Security console, click **Application Domains**.
3. In the page that appears, enter the name of the Application Domain you want to find (or partial name and wild card, *, or leave the field blank to retrieve all domains). For example:

DesiredDomain

4. Click the **Search** button to initiate the search.
5. Choose a name in the Search Results table to perform the desired task. For instance:
 - **Edit:** Click the **Edit** button in the tool bar to display the configuration page and go to "[Viewing or Editing an Application Domain](#)".
 - **Delete:** See "[Deleting an Application Domain and Its Contents](#)" before you perform this task.
 - **Detach:** Click **Detach** in the tool bar to expand the table to a full page.
 - **View:** Select a **View** menu item to alter the appearance of the results table.

25.4.3 Viewing or Editing an Application Domain

Users with valid Administrator credentials can view or modify an Application Domain (including its resources, policies, conditions, and responses) using the Oracle Access Management Console.

Oracle recommends that you consider grouping similar applications into the same Application Domain. While editing the Application Domain, be aware that different applications are using the same domain. Editing the description and domain name are supported.

See Also:

["Managing Policies and Application Domains Remotely"](#)

To view or modify an Application Domain and its content

1. Locate the desired Application Domain as described in "[Searching for an Existing Application Domain](#)".
2. Click to open each of the following tabs to add, view, modify, or delete specific details:
 - **Resources:** See "[Adding and Managing Policy Resource Definitions](#)".
 - **Authentication Policies:** See "[Defining Authentication Policies for Specific Resources](#)".
 - **Authorization Policies:** See "[Defining Authorization Policies for Specific Resources](#)".
 - **Token Issuance Policies:** See "[Managing Token Issuance Policies, Conditions, and Rules](#)".

25.4.4 Deleting an Application Domain and Its Contents

Users with valid Administrator credentials can delete an Application Domain (including its resources, policies, conditions, and responses) using the Oracle Access Management Console.

Deleting the Application Domain and its content removes all referenced objects, including the Agent registration. Using this method, if you later need to re-register the same Agent, you can because there are no remaining references to the previous Application Domain and its content.

Note:

During a Delete operation, if the Application Domain contains any policy elements, you are alerted.

Prerequisites

Ensure that resources in the domain to be deleted are placed in another Application Domain for protection.

To delete an Application Domain

1. Locate the desired Application Domain as described in "[Searching for an Existing Application Domain](#)".
2. Ensure that resources in the domain to be deleted are placed in another Application Domain for protection.
3. In the Search Results table, click the Serial Number beside the desired name, and then click the **Delete (x)** button in the tool bar.
4. In the Warning window, click **Delete** (or click **Cancel** to dismiss the window).
5. Check the results table to confirm the Application Domain has been removed.

25.5 Adding and Managing Policy Resource Definitions

Protecting resources requires an Application Domain containing definitions of the specific resources.

With OAM, you can protect different types of resources, including non-HTTP/HTTPS-based resources and HTTP/HTTPS-based resources such as:

- An entire external Web site
- Specific pages in a Web site
- Partner portals
- A parts order application
- Invoice applications
- A benefits enrollment application on Web servers of an enterprise in many countries

Once you have defined a resource in this container, you can add it to a policy in the Application Domain. This section provides the following topics:

- [Resources in an Application Domain](#)
- [Searching for a Resource Definition](#)
- [Defining Resources in an Application Domain](#)
- [Viewing, Editing, or Deleting a Resource Definition](#)

25.5.1 Resources in an Application Domain

Each resource must be defined separately in an Application Domain. Within an Application Domain, resource definitions exist as a flat collection of objects. Each resource is defined as a specific type, and the URL prefix that identifies the resource (document or entity) stored on a server and available for access by a large audience.

The location is specified using an existing shared Host Identifier.

Note:

If a resource that is not explicitly marked as excluded, is not associated with a policy, then access is denied to all users because there is no policy match.

Resource Definition Guidelines

1. No URL prefixes. Resource definitions are treated as complete URLs.
2. Pattern matching (with limited features) for:
 - '*' and '...' are supported
3. Resources need not be unique across domains.
4. Query-string protection for HTTP URLs.
5. Each HTTP resource is defined as a URL path, and associated with a host identifier. However, resources of other types are associated with a specific name (not a host identifier).
6. Non-HTTP resource types are supported, with definition of specific operations. Non-HTTP resource types are never associated with a host identifier.
7. Resources can be designated as either Protected, Unprotected, or Excluded.
8. Custom resource types are allowed.

Figure 25-10 illustrates the Create Resource page.

Figure 25-10 Create Resource Page in the Application Domain

Create Resource Resource Apply

Use the following screen to define a Resource and the URL prefix that identifies the resource (document or entity) stored on a server. Individual resource URLs need not be unique across domains, but the combination of a resource URL, Query String, and a host identifier must be unique across domains.

* Type

Description

* Host Identifier

Uri

* Resource URL

Query Name Value list String

Query	
Name	Value
No Data to Display	

Operations

* Operations Available

- All
- CONNECT
- OPTIONS
- POST
- PUT

Protection

* Protection Level

Authentication Policy

Authorization Policy

Table 25-1 describes elements that comprise a resource definition.

Table 25-1 Resource Definition Elements

Elements	Description
Type	<p>The HTTP type is the default; it covers resources that are accessed using either the HTTP or HTTPS protocol. Policies that govern a particular resource apply to all operations defined for the resource.</p> <p>The w1_authen resource type is used for Fusion Middleware application scenarios, as described in the <i>Securing Applications with Oracle Platform Security Services</i>.</p> <p>The TokenServiceRP resource type is used to represent the Token Service Relying Party as described in "Managing TokenServiceRP Type Resources".</p> <p>Any custom resource type that has been defined is listed with default resource types when you add a resource definition (or search for resources).</p> <p>See Also: "Resource Type in a Resource Definition".</p>
Description	An optional unique description for this resource.
Host Identifier	<p>A list of host identifiers is available, which contains all identifiers that were defined as a shared component. You must choose a host identifier to assign this resource.</p> <p>Note: The combination of the host identifier and URL string that make up a resource definition must be unique across all Application Domains.</p> <p>See Also: "Managing Host Identifiers".</p>
URI Section	Information will differ depending on the selected Resource Type.
Query Name-Value list	<p>For HTTP resource types only. You can provide a list of Name and Value pairs for use in access policies.</p> <p>See Also: "Query String Name and Value Parameters for Resource Definitions".</p>
Query String	<p>For HTTP resources, you can provide a query string for literal full query string matching within access policies.</p> <p>See Also: "Literal Query Strings in Resource Definitions".</p>
Resource URL	<p>The value must be expressed as a single relative URL string that represents a path component of a full URL composed of a series of hierarchical levels separated by the '/' character. The URL value of a resource must begin with / and must match a resource value for the chosen host identifier.</p> <p>Based on its contents, a URL is matched in response to an incoming request as a literal or a wild card pattern. The special characters available to define a pattern, if included, are:</p> <ul style="list-style-type: none"> • The asterisk (*) is allowed only at the lowest, terminating level of the path. The asterisk matches zero or more characters. • An ellipses (...) is allowed at any level of the path except the terminating level. The ellipses represents a sequence of zero or more intermediate levels. <p>See Also Table 25-2.</p>
Operations Section	<p>You can define specific allowed operations to customize you own resource definitions.</p> <p>Note: Oracle-provided Resource Types are read-only. Operations associated with Oracle-provided Resource Types need not be defined and cannot be modified. Policies developed and applied to resources of Oracle-provided types apply to all operations.</p>

Table 25-1 (Cont.) Resource Definition Elements

Elements	Description
Operations Available	<p>Identify all HTTP operations that are allowed for this resource definition. Policies developed and applied to this customized resource apply to only the operations you identify. Unless explicitly noted, all of the following possible operations are for HTTP resource types:</p> <ul style="list-style-type: none"> • Connect • Options • Put • Post • Trace • Head • Delete • Connect • Login (wl_authen resource type only) • Issue (TokenServiceRP resource type only) <p>Note: During Agent registration, if no operation is specified for the resource definition itself, then All operations for that resource type are supported.</p> <p>See Also: "Resource Types and Their Use".</p>
Protection	<p>Using the controls in this section of the Resource Definition, you can identify the desired level of protection for this resource and name the policies to be used.</p>
Protection Level	<p>Choose the appropriate protection level from the following:</p> <ul style="list-style-type: none"> • Protected (the default) <p>Protected resources are associated with a protected-level Authentication policy that uses a variety of authentication schemes (LDAP, for example).</p> <p>Authorization policies are allowed for protected resources.</p> <p>Responses, conditions, auditing, and session management are enabled for protected resources using a policy that protects the resource.</p> • Unprotected <p>Unprotected resources are associated with an unprotected-level Authentication policy (level 0) that can use a variety of authentication schemes (LDAP, for example).</p> <p>Authorization policies are allowed for unprotected resources, and a basic one is needed to allow such access. However, an elaborate policy with conditions and responses is irrelevant.</p> <p>Responses, conditions, and auditing are enabled for Unprotected resources using a policy that protects the resource. Only Session Management is not enabled.</p> <p>Access to Unprotected resources incur an OAM Server check from Webgate, which can be audited.</p> • Excluded (these are public) <p>Only HTTP resource types can be excluded. Typically security insensitive files like Images (*.jpg, *.png), protection level Excluded resources do not require an OAM Server check for Authentication, Authorization, Response processing, Session management, and Auditing. Excluded resources cannot be added to any user-defined policy in the console.</p> <p>While allowing access to excluded resources, Webgate does not contact the OAM Server. Therefore, such access is not audited. Most regular resource validations apply to Excluded resources. However, excluded resources are not listed when you add resources to a policy.</p> <p>There is no Authentication or Authorization associated with the resource.</p>

Table 25-1 (Cont.) Resource Definition Elements

Elements	Description
Authentication Policy	A list of Authentication policies based on the specified resource protection level becomes available. Only policies within this domain, and that match the specified protection level, are listed.
Authorization Policy	A list of authorization policies defined in the domain become available from which you can choose the one to protect this resource.

After adding the resource, it is grouped under the Resources node of the named Application Domain. When you create policies all defined resources for the domain are listed and you can choose one or more for inclusion in the policy.

For more information about different specifications within a resource definition, see the following topics:

- [Resource Type in a Resource Definition](#)
- [Host Identifier in a Resource Definition](#)
- [Resource URL, Prefixes, and Patterns](#)
- [Query String Name and Value Parameters for Resource Definitions](#)
- [Literal Query Strings in Resource Definitions](#)
- [Run Time Resource Evaluation](#)

25.5.1.1 Resource Type in a Resource Definition

When adding a resource definition to an Application Domain, Administrators must choose from a list of defined Resource Types. Native Resource Types are read-only cannot be modified or deleted; these include HTTP, TokenserviceRP, and wl_authen.

See Also:

["Resource Types and Their Use"](#)

When adding an HTTP type resource to an Application Domain, Administrators choose from a list of existing host identifiers and then add the resource URL. Operations associated with the HTTP resource type need not be defined by an Administrator. Instead, policies apply to all HTTP operations.

Table 25-2 shows sample URL values for resources. For more information, see ["Resource URL, Prefixes, and Patterns"](#).

Table 25-2 HTTP Resources Sample URL Values

Resource	Sample URL Values
Directories	<ul style="list-style-type: none"> • /mydirectory • /mydirectory/**

Table 25-2 (Cont.) HTTP Resources Sample URL Values

Resource	Sample URL Values
Pages	<ul style="list-style-type: none"> • /mydirectory/projects/index.html • /mydirectory/projects/*.html • /mydirectory/.../*.html
Web applications	<ul style="list-style-type: none"> • /mydirectory/projects/example.exe • /mydirectory/projects/*.exe • /mydirectory/**

25.5.1.2 Host Identifier in a Resource Definition

Administrations identify resources in an Application Domain by the host where the resources reside and the resource URL.

Note:

Non-HTTP resource types are not associated with a host identifier. Instead, Administrators must enter the type's name into the Resource URL field of the resource definition page.

Host identifiers create a context for each resource, which is useful when adding resources that have the same URL paths on different computers. Administrations can protect all of these resources in the same way within the same Application Domain. The only variable that distinguishes one set of resources from another is identification of its host computer.

All defined host identifiers appear on the Host Identifiers list on the Resources page. When adding a resource to an Application Domain, administrations must choose one host identifier for the computer hosting the resource.

To ensure that Access Manager recognizes the URL for a resource, Access Manager must know the various ways used to refer to that resource's host computer.

25.5.1.3 Resource URL, Prefixes, and Patterns

During automated Application Domain generation, a URL prefix is defined under which all resources are protected. The Access Manager policy model does not support a resource prefix. Administrators can create granular URL patterns.

Resources are linear, not hierarchical. Resource definitions are treated as complete URLs.

Note:

No host identifier is associated with a non-HTTP resource type.

Administrations identify individual resources in the Application Domain using a specific resource URL. Individual resource URLs need not be unique across domains. However, the combination of a resource URL, Query String, and a host identifier must be unique across domains.

An HTTP type resource is expressed as a single relative URL string representing a path. The string is composed of a series of hierarchical levels separated by the '/' character. Based on its content, a URL is matched in response to an incoming request as a literal or a wild card pattern.

URL Prefixes

The Access Manager policy model does not support a resource prefix. In other words, there is no policy inheritance.

If a policy is defined for `/mydirectory/projects/`, it only applies to this URL (and does not apply to `/mydirectory/projects/index.html`, for example).

If you need a policy for all resources with the same prefix string, you can define the resource using special characters (three periods ... (ellipsis) or * (asterisk) for instance: `/mydirectory/projects/.../*`.

Note:

There is no policy inheritance in the Access Manager policy model.

URL Patterns, Matching, and Precedence

The granular URL patterns specify the fine-grained portion of a resource's namespace. All matching is case insensitive.

- Supported wildcard matching is provided for the patterns in [Table 25-3](#)
- Sample Resource URLs and their correctness are shown in [Table 25-4](#)

Table 25-3 Supported Wildcards in Resource URL Patterns (Precedence Order)

Pattern	Description	Example
<code>/**</code>	<p>The default. Matches any sequence of zero or more characters that starts with the forward slash character (/).</p> <p>You can use this pattern to protect a path under a specific, named directory.</p> <p>Note: This is not an existing 10g wildcard. In 10g, the <code>/.../*</code> pattern yielded an exclusive match that did not include the root of the level at which the pattern was defined. For example, <code>/foo/.../*</code> matched <code>/foo/bar</code> and the root directory <code>/foo/</code> itself, but it wouldn't match <code>foo/</code> or <code>/foo</code>. 10g had the notion of a prefix (the "root"), and most evaluation occurred after stripping off the prefix.</p>	<p><code>./**</code></p> <p>Matches</p> <p><code>/foo/bar</code></p> <p><code>/foo/</code></p>
Literals	The resource's pattern contains no special characters.	
<code>{pattern1,pattern2,...}</code>	<p>Matches one from a set of patterns.</p> <p>The patterns inside the braces can themselves include any other special characters (except braces; sets of patterns cannot be nested).</p>	<ul style="list-style-type: none"> • <code>a{ab,bc}b</code> matches <code>aabb</code> and <code>abcb</code>. • <code>a{x*y,y?x}b</code> matches <code>axyb</code>, <code>axabayb</code>, <code>ayaxb</code>, and so on.

Table 25-3 (Cont.) Supported Wildcards in Resource URL Patterns (Precedence Order)

Pattern	Description	Example
[range or set]	<p>Matches one from a set of characters.</p> <p>A set can be specified as a series of literal characters or as a range of characters. A range of characters is any two characters (including -) with a hyphen (-) between.</p> <p>A range of characters is any two characters (including -) with a hyphen (-) between them.</p> <p>The forward slash character (/) is not a valid character to include in a set.</p> <p>A set of characters will not match / even if a range that includes / is specified.</p>	<ul style="list-style-type: none"> • [nd] matches only n or d. • [m-x] matches any character between m and x, inclusive. • [--b] matches any character between - and b inclusive (except for /; see /usr/pub/ascii for order of punctuation characters). • [abf-n] matches a, b, and any character between f and n, inclusive. • [a-f-n] matches any character between a and f inclusive, -, or n. (The second - is interpreted literally because the f preceding it is already part of a range.)
Single Character Wildcard ?	The ? (question mark) matches any one character other than /. This is not treated as a query string delimiter.	a?b matches aab and azb but not a/b.
Wildcard *	The * (asterisk) wildcard matches any sequence of zero or more characters. However, the * (asterisk) does not match the forward slash character (/).	a*b matches ab, azb, and azzzzzzb but not a/b.
*	<p>The * (asterisk) can be used only at the lowest, terminating level of the path. It matches zero or more characters.</p> <p>Every character in a URL pattern must match the corresponding character in the URL path exactly.</p> <p>Exceptions:</p> <ul style="list-style-type: none"> • At the end of a pattern, /* matches any sequence of characters from that point forward. • The pattern *.extension matches any file name ending with the named extension. • Does not match /. 	<p>The following URL pattern:</p> <pre>.../update.html</pre> <p>Matches:</p> <pre>/humanresources/benefits/update.html /corporate/news/update.html update.html</pre> <p>See Also: Table 25-4</p>
/.../ Hierarchy	Matches any sequence of one or more characters that starts and ends with the forward slash character (/).	<ul style="list-style-type: none"> • The pattern /.../index.html matches: <pre>/index.html/oracle/index.html/ oracle/sales/index.htmlindex.html</pre> <p>It does not match xyzindex.html or xyz/index.html.</p>
/.../* Host wide	<p>Evaluation descends from the root /. At each directory level, resources matching the highest precedence level are selected as candidates for continued evaluation and then descend to the next level. This continues until resources representing the best match possible, based solely on the path information, is obtained.</p> <p>Host wide; the entirety of the pattern.</p>	<ul style="list-style-type: none"> • /oracle/.../*.html matches: <pre>/oracle/index.html/oracle/sales/ order.html, and so on.</pre>

Table 25-3 (Cont.) Supported Wildcards in Resource URL Patterns (Precedence Order)

Pattern	Description	Example
\	<p>The backslash character is used to escape special characters. Any character preceded by a backslash matches itself.</p> <ul style="list-style-type: none"> Escaped special characters need to be ignored if putting the pattern in wildcard buckets Escaped special characters are matched literally to the special characters, if any, within the incoming URL 	<ul style="list-style-type: none"> abc*d only matches abc*d abc\\d only matches abc\d

Table 25-4 illustrates a number of resource definitions within an Application Domain, organized alphabetically according to the Host Identifier and Resource URL. The right-hand column in Table 25-4 declares whether the form is correct or not.

Table 25-4 Sample Resource URLs

Resource URL	Correct Form
/bank/accounts/*	Yes
/bank/accounts/*.jsp	Yes
/bank/accounts/checking	Yes
/bank/.../checking.jsp	Yes
/.../*.jsp	Yes
/bank/accounts/checking*.jsp	No
/bank/accounts/c*.jsp	No
/bank/.../accounts/def.gif	No

25.5.1.4 Query String Name and Value Parameters for Resource Definitions

The Policy Model supports Query String Name and Value parameters in a Resource pattern definition

- Name:** A string literal that can contain any characters, including symbols; all characters are treated as literal.
- Value:** Can be a string literal with any characters and can contain a wildcard (*) only) to match a sequence of 0 or more characters. Asterisk (*) is treated as a wildcard.
- Amount:** There is no limit to the number of name and value pairs in a query string. However, for a single resource there will be only a few pairs.
- Order:** Any order can be used for name and value pairs because at run time these might come in any order as part of the query string.

Resource Matching and Precedence: Query String Name and Value Parameters

Access Manager uses an algorithm that locates the least specific match and continues to the most specific possible resource. When you have candidates defined with both a

single-query string and query parameters, those with the single string take precedence.

For resources containing parameter lists, the best match is determined as follows:

1. **Path Matching:** Access Manager attempts to match the path of the requested resource. There may be multiple candidates matched, differing by query component and/or operations declared.
2. **Query String Matching:** For matches obtained, Access Manager attempts to match the query string (if present in the requested URL). If candidates are defined with both single query string and query parameters, those with the literal string take precedence. There may be multiple candidates remaining, differing by operation.
3. **Operation Matching:** For matches obtained, attempt to match the requested operation. If there is no exact match present, then check for resources for which no specific operation(s) have been defined. In other words, they apply to any operation defined as part of the resource's type. In either case, this yields a single, best match.

Path Matching: Defined resources are evaluated for potential match, against the requested URL's path component, in the following precedence order:

- Literals (as in, the resource's pattern contains no special characters)
- Choice: $\{pattern1,pattern2,\dots\}$, each of which may itself contain the below special characters and is evaluated, in turn, using this same precedence order
- Range: []
- Single-char wildcard: ?
- Wildcard: *
- Hierarchy: /.../
- Hostwide: /.../* is the entirety of the pattern

Evaluation descends from the root '/'. At each directory level, resource(s) matching with the highest precedence level are selected as candidates for continued evaluation and then descent to the next level occurs. This continues until resource(s) representing the best match possible, based solely on the path information, is obtained.

Note:

All matching in 11g has been, and remains, case insensitive.

Table 25-5 illustrates the matching pattern for each of several requested URLs.

Table 25-5 Pattern Matching for Requested URLs

Requested URL	Matching Pattern
/oam/sales/oam/page8.html	/oam/.../*.html
/oam/Dept1/page8.html	/oam/Dept?/page8.html

Table 25-5 (Cont.) Pattern Matching for Requested URLs

Requested URL	Matching Pattern
/oam/DeptQ/page8.html	/oam/Dept[A-Z]/page[1-8].html
/oam/DeptQ/page8.html	/oam/Dept[A-Z]/page?.html
/oam/saals/foo/aba/zzz/index.html	/oam/sa{*,le,l?,a[k-m],[a-f-m]}s/.../{*b,?a}{a,..//ii}/.../{index,test}[pa].?tml

Query String Matching:

When you have candidates defined with both single query string and query parameters, those with the single string take precedence. Single query strings are scored using the algorithm already-mentioned.

For resources containing parameter lists, the best match is determined as follows:

- Resources with parameter values without wildcards are given higher order of precedence; the combined length of the parameter names and values is used to determine the best match among the set of such resources.
- As for query string literals, if there are two or more matches with the same combined length, then matching will fail.
- Resources with parameter values containing wildcards are considered next. The total number of wildcards within each resource is used to determine the best match among such resources. If there are two or more matches having same number of wildcards, then the combined length of the parameter names and values determines the best match
- Matching fails if multiple resources contain the same combined length.

Query String Matching Patterns: Second and subsequent patterns use parameter lists:

```

/oam/index.html::a=*d (a single query string)
/oam/index.html::a:b
/oam/index.html::a:b,c:d
/oam/index.html::a:b*
/oam/index.html::a:b*,c:d
/oam/index.html::a:b*,c:d*
/oam/index.html::a:b*,c:*d*

```

Table 25-6 illustrates the matching pattern for each of several requested URLs.

Table 25-6 Query String Matching: Examples

Requested URL	Matching URL Pattern	Matching Query String Pattern
/oam/index.html?a=b&c=d	/oam/index.html	a=*d
/oam/index.html?a=b1&c=d	/oam/index.html	a:b*,c:d
/oam/index.html?a=b1,c=d1	/oam/index.html	a:b*,c:d*

Table 25-6 (Cont.) Query String Matching: Examples

Requested URL	Matching URL Pattern	Matching Query String Pattern
/oam/index.html?a=b1,c=1d1	/oam/index.html	a:b*,c:*d*

Operation Matching Examples: At this point in request processing, there are one or more candidate resources, all of which match the requested URL path and query string components equally. Access Manager now matches the requested operation to one of those candidates: a resource defined to protect that operation specifically (as well as other, specific operations). As only a single resource can be defined to protect any given operation, this will give the single best match.

Note:

If this does not give a match, verify that the candidate exists protecting all operations (meaning it has been defined using "All", and protects no specific operations).

Run Time Evaluation: Name value pairs are evaluated at run time as follows:

NAME VALUE

a ab

a a*

Same Resource URL Specified Differently: Resources with the same URL and with the same characters in the query string (although specified differently in the console (one as a key and value and the other as a single string)) are considered different and are allowed. For example, the two following resource patterns are considered as different:

Resource URL: /test.html

Query string: area=*&dept=*

Resource URL: /test.html

Query NAME VALUE

area *

dept *

Resource Matching During Policy Evaluation: The order in which name and value pairs arrive at run time does not matter. As long as all the names and values match the query string, the match is successful. The incoming request can have more name and value parameters than defined and still have a successful match.

Example 1: The following pattern matches the incoming URL if no other pattern is defined with the same URL, query string variables, and the extra query string variable (revenue=1000):

Incoming URL => /test.html?area=emea&dept=engg&revenue=1000

resource pattern => /test.html

```
Query String NAME VALUE
area emea
dept engg
```

Example 1: For a resource with the same resource URL and the same query string, with one defined as a single string and the other defined as name and value pairs, the policy evaluation preference matches the literal query string before considering name and value pairs. For instance, in the following example, a) is matched:

Runtime Request: URL => /test.html?area=emea&dept=engg

Resource Patterns:

a)

Resource:/test.html

Query string: area=emea&dept=engg

b)

Resource:/test.html

```
Query String NAME VALUE
area emea
dept engg
```

Best Match, Multiple Resources: When you have multiple resources with query string name and value pairs defined, the best resource match is the pattern that matches the most number of query string parameters. When wildcard values are used, this is followed by how closely each parameter value matches.

For example: With the following two query string patterns defined:

```
Query String NAME VALUE
area e*
dept e*
and
area em*
dept en*
```

Run Time Query String Parameters:

```
area emea
dept engg
```

Result: The second name and value pattern match order is higher.

Figure 25-11 shows the resource definition page. Here, "rev*" is a valid name (the asterisk character is allowed and treated as a literal character, which is equivalent to 10g behavior). The Oracle Access Management Console enables you to add query strings as name and value pairs. You can also add the query string as a literal string. If you select a literal query string, then the name and value option is disabled (and vice versa).

Figure 25-11 HTTP Resources, Query String Resource URL Controls

Uri

Resource URL

Query Name Value list String

Name	Value
region	<input type="text"/>
dept	rev*

Behavior When Migrating to Access Manager: If you upgrade to Access Manager (from 10g), previous query strings are created in 11g appropriately (whether a single string or a name and value pair). The appropriate type of query string is created in Access Manager.

25.5.1.5 Literal Query Strings in Resource Definitions

The Policy Model supports resource protection based on matching literal, full query-string-based HTTP resource definitions within Access Policies. A single Query String Pattern that would be matched against the entire input Query string (as opposed to matching only portions—selected name and value pairs—of the query string).

For example:

```
status=active&adminrole=*
```

A Query String pattern specified as a regular free form string with these extra features:

- Optional: Special character (*) that matches zero or more characters, which is applied to a set of names in the run time Query String.
- Two resource definitions can exist with same URL base path pattern and different Query String patterns. These two are independent and non-equal resources. For example, these are all valid and can exist at same time:

```
/foo
/foo?bar=true
/foo?bar=false
```

The Query String is free form with no restriction in terms of format or characters. It is not required to specify Query String as key/value pairs

At run time, only the Query String that is part of HTTP GET requests is processed; Query String pattern does not apply to HTTP POST data.

Resource Matching at run time:

- The base URL path is matched and then the Query String is matched
- Multiple resource patterns that contain matching Query Strings: The best match is determined based on the number of tokens (pattern delimited by "&") and the length of the token at each position. Patterns with longer tokens in the beginning are preferred and then the pattern that contains more number of tokens. (If there are matching patterns that contain same number of tokens and same length at each position then the match would fail.)

Conflicts:

- **Super Set:** The input resource definition contains a set of name-value Query String patterns that are a super set of patterns of an existing resource definition in the policy store.
- **Overlap:** The input resource specification contains a set of name-value Query string patterns that overlap a set of patterns of an existing resource definition in the policy store.

Remote Registration: For OAM Agents, the remote registration tool (oamreg) accepts Query-string based HTTP resource definitions and generates the relevant policy objects for securing access of these resources. If any conflicts are encountered during policy provisioning, only policies for resources that do not have any conflicts are provisioned. This feature does not apply to 10g OSSO agent-based partners and applications. OSSO agents are not capable of enforcing authentication scheme per resource. Instead, a single authentication scheme is applied to all resources of an application.

25.5.1.6 Run Time Resource Evaluation

While processing requests for resources, an evaluation is made to ensure that the proper policy is invoked for the resource.

See Also:

Other processing details in the following topics:

- ["Resource URL, Prefixes, and Patterns"](#)
 - ["Query String Name and Value Parameters for Resource Definitions"](#)
 - ["Literal Query Strings in Resource Definitions"](#)
 - ["Managing Run Time Policy Evaluation Caches"](#)
-
-

Process overview: Resource evaluation

1. A user specifies the URL for a requested resource.
2. Access Manager creates a fully qualified URL that includes the URL pattern, based on the host identifier and URL.
3. Access Manager compares the incoming URL for the requested resource to the fully-qualified URL constructed from Application Domain information and the policy's URL pattern:
 - If there is a match, the various policies are evaluated to determine whether the requester should be allowed or denied access to the resource.
 - If the requester is allowed access, the resource is served.

[Table 25-7](#) describes the possible outcomes.

Table 25-7 Resource Evaluation Outcomes

Outcome	Description
Best Match	The best match is when a resource definition has the least resource scope compared to other possible matches to the run time resource. The term resource scope represents all possible resources that could be matched using a particular resource definition
No Match1	If no match is found, the default evaluation outcome is FAILURE. Depending on what kind of policy was being evaluated, this could mean no authentication is attempted, or no resource access is granted.

Look Up Mechanism Examples

- The default resource URL in an Application Domain defines the broadest scope of content possible (all directories and below):

```
/. . . /*
```

- The pattern `/.../index.html` matches:

```
/index.html
/oracle/index.html
/oracle/sales/index.html
```

It does not match, for example, `xyzindex.html`.

- `/oracle/.../*.html` matches:

```
/oracle/index.html
/oracle/sales/order.html
and so on
```

Resource Scope Examples

- Resource scope of the following resource definition (includes the asterisk):

```
/mybank/.../*
```

includes all URLs prefixed with `"/mybank/"`

- Resource scope of the following resource definition (no special characters in the definition):

```
/mybank/account.html
```

includes only one URL: `"/mybank/account.html"`

25.5.2 Defining Resources in an Application Domain

Users with valid Administrator credentials can add the resource definitions to protect to the corresponding Application Domain.

Resource protection based on a list of discrete query parameters is more secure and easier to administer than literal query strings. You might want to create a policy based on resource URL with query parameters (string and name-value pairs).

Note:

An error can occur if you specify a host identifier value that is invalid: The challenge URL is invalid.

Prerequisites

The Resource Type must be defined as a Shared Component. Several elements in the Resource definition page are based on the defined and selected Resource Type. For details, see "[Managing Resource Types](#)".

See Also:

["Resources in an Application Domain"](#)

To add resource definitions to an Application Domain

1. In the Oracle Access Management Console, locate and view the desired Application Domain, as described in "[Searching for an Existing Application Domain](#)".
2. In the Application Domain, click the **Resources** tab, then click the **New Resource** button in the upper-right corner of the Search page.
3. On the **Resource Definition** page:
 - a. Select or enter your details for a single resource ([Table 25-1](#)):
 - Type
 - Description
 - Host Identifier
 - Resource URL ([Table 25-4](#))
 - Operations
 - Query String ([Table 25-6](#))
 - Protection Level
 - Authentication Policy (*if level is Protected*)
 - Authorization Policy (*if level is Protected and Authentication Policy is chosen*)
 - b. Click Apply to add this resource to the Application Domain.
 - c. Repeat this procedure to add other resources to this Application Domain.
4. Proceed by adding defined resources to specific policies in the Application domain as described in:
 - [Defining Authentication Policies for Specific Resources](#)
 - [Defining Authorization Policies for Specific Resources](#)
 - [Managing Token Issuance Policies, Conditions, and Rules](#)

25.5.3 Searching for a Resource Definition

This section provides the following topics:

- [Search Elements and Results for Resource Definitions in an Application Domain](#)
- [Searching for a Specific Resource Definition](#)

25.5.3.1 Search Elements and Results for Resource Definitions in an Application Domain

You can simply click the Search button using the defaults or refine your search by supplying information needed to find the resource.

Figure 25-12 shows the default Search elements and Search Results table for resource definitions in an Application Domain.

Figure 25-12 Resource Search within an Application Domain

Use the search tool to find an existing Resource or click the New Resource button to create a new one.

Search

Resource Type: HTTP
 Host Identifier:
 Resource URL:
 Query String:
 Authentication Policy:
 Authorization Policy:

Search Results

Actions:

Row	Resource Type	Host Identifier	Resource URL	Query String	Authentication Policy	Authorization Policy
1	HTTP	IAMSuiteAgent	/ucs/**			
2	HTTP	IAMSuiteAgent	/reqsvc/**			
3	HTTP	IAMSuiteAgent	/sts/**			
4	HTTP	IAMSuiteAgent	/oamfed/**			
5	HTTP	IAMSuiteAgent	/oam/serverfed/authn/sc...		LocalAuthnFederationFA...	Protected Resource Policy

Table 25-8 lists out the search elements and details.

Table 25-8 Search Elements for a Resource in an Application Domain

Search Elements	Description
Resource Type	Provides a list of defined resource types from which you can choose. You can also leave this blank. Default: HTTP
Host Identifier	Enter a host identifier here, if desired. You can leave this blank Default: blank
Resource URL	Enter a resource URL, if desired. You can leave this blank Default: blank
Query String	Enter a query string for the resource, or leave this blank. You can include this in the search criteria if a query string was defined for the resource when it was added to the Application Domain. Default: blank
Authentication Policy	Provides a list of defined authentication policies for this Application Domain. You can choose one or leave the space blank. Default: blank
Authorization Policy	Provides a list of defined authorization policies for this Application Domain. You can choose one or leave the space blank. Default: blank

You can click **Reset** to clear the form or **Search** to initiate the search. Each resource listed includes everything specified when it was added to the domain. The **Actions** and **View** menus are available for use with the table. Also you can click the **Create** command button to add a new resource definition to this domain.

25.5.3.2 Searching for a Specific Resource Definition

Users with valid Administrator credentials can search for a specific resource definition.

To find a resource definition:

1. In the Oracle Access Management Console, locate and view the desired Application Domain, as described in "[Searching for an Existing Application Domain](#)".
2. Click the **Resources** tab to display Resources Search controls.
3. Fill in your search criteria ([Table 25-8](#)), and click the **Search** button.
4. In the Search Results table, click the desired resource definition and take the desired action:
 - **Actions Menu:** Select an item to Create, Edit, or Delete the selected resource.
 - **View Menu:** Select an item to alter the appearance of the results table.
 - **Edit Button:** Click the button in the tool bar to display the configuration page.
 - **Delete:** See "[Viewing, Editing, or Deleting a Resource Definition](#)".
 - **Detach:** Click Detach in the tool bar to expand the table to a full page.

25.5.4 Viewing, Editing, or Deleting a Resource Definition

Users with valid Administrator credentials can modify resource definitions within a specific Application Domain.

If a resource protection level is modified from "Protected" to "Excluded" while it is associated with a policy, the modification will fail. First, remove the resource from the policy, make the change, and add the resource to the policy.

Note:

During a Delete, you are alerted if the resource is associated with a policy. Without a policy association, the resource is deleted.

Prerequisites

You must have the desired resource type defined as a shared component. For details, see "[Managing Resource Types](#)".

See Also:

["Resources in an Application Domain"](#)

To view, modify, or delete resource definitions

1. Find the Resource, as described in "[Searching for a Resource Definition](#)".
 - **View Only:** Close the page when you finish.
 - **Modify:** Alter the definition as desired and then click **Apply** to submit changes (or close the page without applying changes).
 - **Delete:**
 - Open the resource definition and confirm this is the one to be deleted, then close the page.
 - Click the name of the desired resource definition and then click the Delete button in the tool bar.
 - In the Confirmation window, click **Delete** (or click Cancel to dismiss the window).

If the Resource is associated with a policy, remove it from the policy first.
 - Repeat as needed to delete other resources in the Application Domain.

25.6 Defining Authentication Policies for Specific Resources

Each resource assigned to an Application Domain can be protected by only one authentication policy. After adding a resource definition to the Application Domain, the Administrator can begin refining a default authentication policy, adding a new policy, and assigning resources to the authentication policy.

In an automatically generated Application Domain, the following authentication policies are seeded as defaults to help streamline the Administrator's tasks:

- Protected Resource
- Public Resource

See Also:

["Understanding Application Domain and Policy Management"](#)

This section provides the following topics:

- [Authentication Policy Page](#)
- [Creating an Authentication Policy for Specific Resources](#)
- [Searching for an Authentication Policy](#)
- [Viewing or Editing an Authentication Policy](#)
- [Deleting an Authentication Policy](#)

25.6.1 Authentication Policy Page

Administrators use authentication policies to protect specific resources. The authentication policy provides the sole authentication method for resources governed by the policy.

Each authentication policy defines the type of verification that must be performed to provide a sufficient level of trust for Access Manager to grant access to the user making the request.

Authentication policies are local. A single policy can be defined to protect one or more resources in the Application Domain. However, each resource can be protected by only one authentication policy.

Authentication Policy Guidelines

1. Authentication policies include resources, success responses, and an authentication scheme.
2. Authentication and Authorization policies can evaluate to Success or Failure.
3. Query Builder and support for LDAP filters (for retrieving matches based on an attribute of a certain display type, for example).
4. Define a policy for resource: /.../* which can be used within a determined scope.
5. Token Issuance Policies can be defined using resources and user- or partner-based conditions.

Figure 25-13 shows the Authentication Policies page of an Application Domain.

Figure 25-13 Sample Authentication Policies Page in the Application Domain

Row	Name	Description
1	LocalAuthnFederationFAAuthScheme	Policy Component created for Local Authentication in IdP mode - Do not modify
2	LocalAuthnFederationLDAPScheme	Policy Component created for Local Authentication in IdP mode - Do not modify
3	LocalAuthnFederationBasicFAScheme	Policy Component created for Local Authentication in IdP mode - Do not modify
4	LocalAuthnFederationBasicScheme	Policy Component created for Local Authentication in IdP mode - Do not modify

Figure 25-14 shows a specific Authentication Policy. The resources assigned to this policy are displayed on the Resources tab of the policy.

Figure 25-14 Sample Individual Authentication Policy Page

Resource Type	Host Identifier	Resource URL	Query String
HTTP	IAMSuiteAgent	/oamreauthenticate/**	
HTTP	IAMSuiteAgent	/logonmanager/**	
HTTP	IAMSuiteAgent	/idaas/am/esso/**	
HTTP	IAMSuiteAgent	/wlm/**	

Table 25-9 describes authentication policy elements.

Table 25-9 Authentication Policy Elements and Descriptions

Element	Description
Name	A unique name used as an identifier.
Description	Optional unique text that describes this authentication policy.
Authentication Scheme	A single, previously-defined authentication scheme to be used by this policy for user authentication. See Also: " Managing Authentication Schemes " for details.
Success URL	The redirect URL to be used upon successful authentication.
Failure URL	The redirect URL to be used if authentication fails.
Resources	The URL of a resource chosen from those listed. The listed URLs were added to this Application Domain earlier. You can add one or more resources to protect with this authentication policy. The resource definition must exist within the Application Domain before you can include it in a policy. See Also: " Resources in an Authentication Policy ".
Responses	The obligations (post authentication actions) to be carried out by the Web agent. After a successful authentication, the application server hosting the protected application should be able to assert the User Identity based on these responses. After a failed authentication, the browser redirects the request to a pre-configured URL See Also: " Introduction to Policy Responses for SSO ".

25.6.1.1 Resources in an Authentication Policy

You can choose to add one or more resources to be protected by the authentication policy.

The Resources tab on the Authentication Policy page provides a table where you can enter resource URLs. A list is also provided from which you can choose from defined resources within the Application Domain.

To add a resource, click the + button and select from the list. To delete a resource, select the name from the Resources table and click the Delete button in the table.

25.6.2 Creating an Authentication Policy for Specific Resources

Users with valid Administrator credentials can add an authentication policy and resources to an Application Domain. You can use a pre-configured authentication scheme or a custom authentication scheme in the authentication policy.

See Also:

- "[Authentication Policy Page](#)"
 - "[Managing Authentication Schemes](#)"
-
-

Prerequisites

Any resource to be added to a policy must be defined within the same Application Domain as the policy.

To add an authentication policy for specific resources

1. Locate the desired domain as described in "[Searching for an Existing Application Domain](#)".
2. Click the **Authentication Policies** tab, then click the **Create Authentication Policy** button to open a fresh page.
3. **Required Elements:** Add your information for this policy.
 - Name
 - Authentication Scheme
4. **Optional Elements** ([Table 25-9](#)): Add as needed for your policy.
 - Description (optional)
 - Success URL
 - Failure URL

Tip:
See [Configuring Success and Failure URLs for Authorization Policies](#).
5. **Add Resources:** A Resource must be defined within the Application Domain before you can add the resource to a specific policy.
 - Click the Resources tab on the Authentication Policy page.
 - Click the Add button on the Resources tab.
 - Click the Search button.
 - Click a URL in the Results table, then click Add Selected.
 - Repeat these steps as needed to add more resources.
6. Click **Apply** to save changes and close the Confirmation window.
7. **Responses:** Add policy Responses as described in "[Adding and Managing Policy Responses for SSO](#)".
8. Close the page when you finish.

25.6.3 Searching for an Authentication Policy

Users with valid Administrator credentials can search for a specific authentication policy.

To search for an authentication policy in an Application Domain

1. Locate the desired domain as described in "[Searching for an Existing Application Domain](#)".
2. Click the **Authorization Policies** tab and:
 - **Edit:** See "[Viewing or Editing an Authentication Policy](#)".

- **Delete:** ["Deleting an Authentication Policy"](#).
- **Detach Table:** Click **Detach** in the tool bar to expand the table to a full page.
- **View Menu:** Select a menu item to alter the appearance of the results table.

25.6.4 Viewing or Editing an Authentication Policy

Users with valid Administrator credentials can modify an authentication policy in an Application Domain.

This includes changing the authentication scheme, adding or removing resources or responses, and altering the Success or Failure URLs.

See Also:

["Authentication Policy Page"](#)

To view or modify an authentication policy

1. Locate the desired policy as described in ["Searching for an Authentication Policy"](#).
2. Click the desired policy name to display its configuration.
3. Edit Policy Elements ([Table 25-9](#)):
4. **Resource:** Click the Resources tab and:
 - **Add:** Click the Add button on the Resources table, click a URL in the list, click Apply.
 - **Delete:** Click a URL in the Resources table, click the Delete button on the table.
5. Click **Apply** to submit changes and close the Confirmation window (or close the page without applying changes)
6. **Responses:** View or edit responses as described in ["Adding and Managing Policy Responses for SSO"](#).
7. Close the page when you finish.

25.6.5 Deleting an Authentication Policy

Users with valid Administrator credentials can delete an authentication policy from an Application Domain.

When you remove the policy, all resource definitions remain within the Application Domain. However, the policy and all responses are eliminated.

Note:

During a Delete operation, you are alerted to confirm removal of the policy. Confirmation is required to complete the operation.

The following procedure describes how to delete the entire policy. To simply alter an element in the policy, see ["Viewing or Editing an Authentication Policy"](#).

See Also:

["Authentication Policy Page"](#)

To delete an authentication policy

1. Locate the desired policy as described in "[Searching for an Authentication Policy](#)".
2. Click the desired policy name to display and confirm this configuration.
3. Ensure that resources governed by this policy are added to a different policy.
4. Delete all responses, as described in "[Adding and Managing Policy Responses for SSO](#)".
5. On the **Authentication Policies** tab, click the Serial Number beside the policy, then click the Delete button in the tool bar.
6. In the Confirmation window, click **Delete** to confirm (or click Cancel to dismiss the window).

25.7 Defining Authorization Policies for Specific Resources

Each resource assigned to an Application Domain can be protected by only one authorization policy.

In an automatically generated Application Domain, the following authorization policies are seeded as defaults:

- Protected Resource
- Public Resource

See Also:

["Understanding Application Domain and Policy Management"](#)

After adding resource definitions to the Application Domain, Administrators can begin refining a default authorization policy, adding a new policy, and adding resources to authorization policies. This section provides the following topics:

- [Authorization Policies for Specific Resources](#)
- [Creating an Authorization Policy and Specific Resources](#)
- [Searching for an Authorization Policy](#)
- [Viewing or Editing an Authorization Policy and Resources](#)
- [Deleting an Entire Authorization Policy](#)

25.7.1 Authorization Policies for Specific Resources

Administrators can create an authorization policy to protect access to one or more resources based on attributes of an authenticated user or the environment. The authorization policy provides the sole authorization protection for resources included in the policy. Authorization policies are local, which means that each policy applies

only to the resources specified for the policy. A policy cannot be derived or applied to any other resource.

A single policy can be defined to protect one or more resources in the Application Domain. However, each resource can be protected by only one authorization policy.

Figure 25-15 shows the Authorization Policy page within an Application Domain. The resources assigned to this policy are displayed on the Resources tab of the policy.

Figure 25-15 Sample Individual Authorization Policy Page

Table 25-10 describes authorization policy elements. The elements are the same regardless of the domain; only the details will differ.

Table 25-10 Authorization Policy Elements and Descriptions

Element	Description
Name	A unique name used as an identifier in the navigation tree.
Description	Optional unique text that describes this authorization policy.
Success URL	The redirect URL to be used upon successful authorization.
Failure URL	The redirect URL to be used if authorization fails.
Summary	General information (usually Name and optional Description).
Resources	One or more previously-defined resource URLs to be protected by this authorization policy.
Conditions	See Also " Introduction to Authorization Policy Rules and Conditions ".
Rules	See Also " Introduction to Authorization Policy Rules and Conditions ".
Responses	See Also " Introduction to Policy Responses for SSO ".

25.7.2 Creating an Authorization Policy and Specific Resources

Users with valid Administrator credentials can add an authorization policy to an Application Domain.

Prerequisites

Any resource to be added to a policy must be defined within the same Application Domain as the policy.

See Also:

["Authorization Policies for Specific Resources"](#)

To create an authorization policy and resources

1. Locate the desired domain as described in ["Searching for an Existing Application Domain"](#).
2. Click the **Authorization Policies** tab, then click the **Create** button to open a fresh page.
3. **Summary Tab:** Add your information to the Summary tab ([Table 25-10](#)).
4. **Add Resources:** The Resource must be defined in the Application Domain before you can add the resource to a specific policy.
 - Click the **Resources** tab on the Authorization Policy page.
 - Click the **Add** button on the Resources tab.
 - Click the **Search** button.
 - Click a URL in the Results table, then click **Add Selected**.
 - Repeat these steps to add more resources.
5. Click **Apply** to save changes and close the Confirmation window.
6. **Responses:** Add policy Responses as described in ["Adding and Managing Policy Responses for SSO"](#).
7. **Conditions:** Add authorization conditions, as described in ["Defining Authorization Policy Conditions"](#).
8. **Rules:** Add authorization rules, as described in ["Defining Authorization Policy Rules"](#).
9. Close the page when you finish.

25.7.3 Searching for an Authorization Policy

Users with valid Administrator credentials can locate a specific authorization policy.

To search for an authorization policy

1. Locate the desired domain as described in ["Searching for an Existing Application Domain"](#).
2. Click the **Authorization Policies** tab and:
 - **Edit:** See ["Viewing or Editing an Authorization Policy and Resources"](#).
 - **Delete:** ["Deleting an Entire Authorization Policy"](#).
 - **Detach Table:** Click **Detach** in the tool bar to expand the table to a full page.
 - **View Menu:** Select a menu item to alter the appearance of the results table.

25.7.4 Viewing or Editing an Authorization Policy and Resources

Users with valid Administrator credentials can view or modify an authorization policy within an Application Domain.

See Also:

["Authorization Policies for Specific Resources"](#)

To view or edit an authorization policy

1. Locate the desired domain as described in "[Searching for an Authorization Policy](#)".
2. **Summary:** Edit as needed ([Table 25-10](#)):
3. **Resource:** Click the **Resources** tab and add or delete resources as needed:
 - **Add:** Click the **Add** button on the Resources table, click a URL in the list, click Apply.
 - **Delete:** Click a **URL** in the Resources table, click the Delete button on the table then confirm.
4. Click **Apply** to submit changes and close the Confirmation window (or close the page without applying changes).
5. **Conditions:** See "[Viewing, Editing, or Deleting Authorization Policy Conditions](#)".
6. **Rules:** See "[Defining Authorization Policy Rules](#)".
7. **Responses:** See "[Viewing, Editing, or Deleting a Policy Response for SSO](#)".
8. Close the page when you finish.

25.7.5 Deleting an Entire Authorization Policy

Users with valid Administrator credentials can delete an authorization policy or simply delete resources within the policy.

Note:

During a Delete operation, you are alerted to confirm removal of the policy. Confirmation is required to complete the operation.

When you remove the entire policy, all resource definitions remain within the Application Domain. However, the authorization policy and the conditions and rules governing access are eliminated.

To simply alter an element in the policy see "[Viewing or Editing an Authentication Policy](#)".

See Also:

["Authorization Policies for Specific Resources"](#)

Prerequisites

Assign resources governed by this policy to another authorization policy, either before or after deleting the policy.

To delete an authorization policy

1. Locate the desired domain as described in "[Searching for an Authorization Policy](#)".
2. **Optional:** Double-click the policy name to review its content, and then close the page when finished.
3. **Delete:** Click the policy name, and then click the Delete button in the tool bar.
4. In the Confirmation window, click Delete (or click Cancel to dismiss the window).
5. Confirm that the policy is no longer listed in the navigation tree.

25.8 Configuring Success and Failure URLs for Authorization Policies

When an Authorization Success or Failure redirect URL is set, the target URL for which the end user is seeking access should be passed along as a parameter.

The following information has relevance when configuring an Authorization policy Success or Failure URL.

- The original resource location will be URL encoded and added as a value to the `oam_res` query parameter before redirecting to the success or failure URL. The following rules are relevant to building the `oam_res` value; during an authorization call, only the `HostIdentifier` is passed so building the URL with a fully qualified host and port is slightly more involved. Here are two examples.

Using the `HostIdentifier`, we find the first fully qualified host:port entry and construct the URL with it. The rest of the entries are then added as query parameters to the resource URL. For example:

```
HostList = [Host hostName="adc00oyf.us.example.com", port=7777",  
Host hostName="11gAgent", port=null",  
Host hostName="adc00oyf.us.example.com", port=80"] ,  
HostIdentifier = 11gAgent
```

The resource URL built will be:

```
HTTP://adc00oyf.us.example.com:7777/index.html?Host1=adc00oyf.us.example.com:80
```

In this second example:

```
HostList =[Host hostName="adc00oyf.us.example.com", port=7777",  
Host hostName="11gAgent", port=null] ,  
HostIdentifier = 11gAgent
```

The resource URL built will be:

```
HTTP://adc00oyf.us.example.com:7777/index.html
```

- To send a Hashed value of the resource URL for security reasons, run the `displayAuthZCallbackKey()` WLST command. This will return a Base64 encoded string value of the AES 128 key which is generated. This key can be used by the OAM server and the receiving app. It is stored in the `oam-config.xml`. The entry in `oam-config.xml` is found under `/DeployedComponent/Server/NGAMServer/Profile`.

```
<Setting Name="AuthZCallBack" Type="htf:map">
<Setting Name="AuthZHashKey"
Type="xsd:string">1E8461DFA32AD746AF28BAAA9F327327941C14CAC216DCFA9AC17985E09
7A0DD603EC1DF5C6D9F5C904ED44952A5D5F</Setting>
<Setting Name="AuthZCallBackEnabled" Type="xsd:boolean">true</Setting>
</Setting>
```

Note:

See *Access Manager WLST Commands* for details on the `displayAuthZCallBackKey()` WLST command.

- If WLST in step 2 is enabled, we also send a hashed value of the original resource URL as a value of the `oam_res_hash` query parameter. For example:

```
http://adc00oyf.us.example.com:7001/SampleLoginWAR/pages/MFALogin.jsp?
oam_res=HTTP%3A%2F%2Fadc00oyf.us.example.com%3A0%2Findex.html%3FHost1
%3D1lgAgent%3Anull&oam_res_hash=45438D536865B256681D328AA1BFD47D5D4D0039
```

25.9 Introduction to Authorization Policy Rules and Conditions

In Access Manager 11g, each Authorization policy includes a rule that defines whether the policy allows or denies access to resources protected by the policy. The rule references conditions that define the user or population to be granted or denied access and other considerations for authorization. Authorization rules and conditions apply to all resources within a specific authorization policy.

Evaluation of conditions and rules determines if the authorization policy applies to the incoming request. The appropriate obligations take affect after successful authentication and work in concert with defined authorization rules, conditions, and responses. For each incoming request, the authorization policy determines if there are any conditions that apply. If so, these conditions are evaluated.

This section provides the following topics:

- [About Allow or Deny Rules](#)
- [Authorization Policy Conditions](#)
- [About Classifying Users and Groups for Conditions](#)
- [Guidelines for Authorization Responses Based on Conditions](#)

25.9.1 About Allow or Deny Rules

In an authorization policy, a Rule contains all (or a subset) of conditions defined for the policy. The effect of the Rule determines the effect of the policy. You can set one or more rule effects (outcomes) per policy. However, you can specify only one Rule per outcome.

The following outcomes can be applied to authorization and token issuance policies:

- Allow authorized users access to a protected resource. If Allow conditions do not apply to a user, the user is not qualified by the policy and, by default, the user is denied access to the requested resource.
- Deny authorized users access to a protected resource.

You can develop simple rules that rely on a single condition, or use expressions to define more complex rules based on multiple conditions. For more information, see "[Expressions and Expression-Based Policy](#)".

25.9.2 Authorization Policy Conditions

A condition is an element that specifies one or more criteria to be satisfied by the access request. Each authorization policy can contain one or more conditions.

In structure, conditions are similar to constraints (in 11.1.1.3 and 11.1.1.5). However, earlier constraints included Allow and Deny rules that are now specified independently on the Rules tab.

Using different condition types, you can:

- Identify the users or groups of users who are either allowed or denied access (based on the rule) to protected resources.
- Stipulate the range of IP addresses who are either allowed or denied access to protected resources.

Note:

If the user's IP address falls outside the range of denied addresses, this by itself is not enough for authorization to be successful. For authorization to be successful, the user must specifically be granted access based on an Allow rule.

- Set a time period defining when the condition applies.
- Specify attributes that enforces evaluation of request context, user session state, and user attributes

The Conditions tab provides a table of defined conditions, organized by name, and a table of details for the selected condition, as shown in [Figure 25-16](#).

Figure 25-16 Individual Authorization Policy Conditions Tab

ESSOReauthAuthzpolicy Authorization Policy Duplicate Apply

Authorization policy contains a set of conditions that define whether a user should be permitted or denied access to the resources protected by the policy. Authorization rules and conditions apply to all resources within a specific Authorization policy.

Summary Resources **Conditions** Rules Responses

View ▾ + Add Edit Delete

Name	Type	Description
AttrCond1	Attribute	
TRUE	True	This condition always evaluates to true.

Condition Details : AttrCond1

Match All Attributes Any Attributes

Attributes

View ▾ + Add Edit Delete

Namespace	Name	Operator	Value
Request	Resource URL	Contains	http
Session	Session Count	Starts With	1

[Table 25-11](#) describes elements and controls on the Conditions tab.

Table 25-11 Authorization Policy Condition Tab

Element	Description
Conditions Table Elements	Lists all conditions defined for this policy.
Name	A unique name used as an identifier for the condition.
Type	The kind of condition you want to use. Only one Type can be specified: <ul style="list-style-type: none"> • Identity • IP4 Range • Temporal • Attribute • True (see Table 21-5)
Description	Optional unique text that describes this condition.
Condition Details Section	Depending on the Type of the selected condition, the information in this table will differ. For details, see: <ul style="list-style-type: none"> • "About Identity Conditions" • "IP4 Range Condition Types" • "Temporal Conditions" • "Attribute-Type Conditions"

25.9.3 About Classifying Users and Groups for Conditions

Oracle recommends that you consider the same information for the policies and conditions when analyzing users and groups to determine who is explicitly allowed or denied access.

For example, one authorization policy might be constrained to a particular time of day (Temporal Type) while another might be constrained to a specific group of users (Identity Type).

Note:

Do not be concerned about users who are denied access under any conditions. Users are denied access by default if none of the conditions qualify them for access.

When classifying users Oracle recommends that you divide the users, and groups of users, into groups for whom different conditions apply. For example, conditions can determine when the users can access the resources, the computers from which they must make their requests, and so on.

If some users fall into multiple categories, for example, a user in the marketing group belongs to a certain project group, or a user in the human resources group also belongs to the project group, put the user in both categories. You can require that the user meet the conditions of two conditions.

To create policies for subsets of resources in an Application Domain and protect them with different authorization rules and conditions, consider the same information: who can access the resources protected by this policy and under what conditions you want explicitly to allow or deny access to the resources.

25.9.4 Guidelines for Authorization Responses Based on Conditions

For each condition type, consider the response actions that you want to occur for authorized users.

You might want the system to return user profile information and pass that information to a downstream application. For example:

- If the user is authorized, you might want to pass the user's common name (cn) to another application so that the application can present a customized greeting to the user.
- If the user is not authorized, you might also want to return information about the user for security purposes.

25.10 Defining Authorization Policy Conditions

The mechanism to add a condition is the same regardless of the type you choose.

You use conditions in an authorization policy to:

- Identify the users by user name, role, or an LDAP filter whose criteria the user must satisfy.
- Stipulate the computers where users can access resources.
- Set a time period when the rule applies.
- Specify attributes that enforces evaluation of request context, user session state, and user attributes

A dialog box pops up where you define the name and type to create the condition container. Afterward you are presented with controls to define the specifics of the condition.

This section is divided as follows:

- [Choosing a Condition Type](#)
- [Defining Identity Conditions](#)
- [Defining IP4 Range Conditions](#)
- [Defining Temporal Conditions](#)
- [Defining Attribute Conditions](#)
- [Viewing, Editing, or Deleting Authorization Policy Conditions](#)

25.10.1 Choosing a Condition Type

This section provides the following topics:

- [Condition Window and Elements](#)
- [Choosing a Condition Type](#)

25.10.1.1 Condition Window and Elements

You can have more than one instance of a given type of condition within a policy.

When an Administrator adds a condition to an authorization policy, a window (Figure 25-17) appears where you enter capture the Name, Type, and optional Description. When submitted, this information is used to create a container for condition details that must be also specified.

Figure 25-17 Add Condition Window

Table 25-12 describes the Add Condition elements.

Table 25-12 Add Condition Window Elements

Element	Description
Name	A unique name for this condition.
Type	Only one Type can be specified: <ul style="list-style-type: none"> • Identity (See "About Identity Conditions") • IP4 Range (See "IP4 Range Condition Types") • Temporal (See "Temporal Conditions") • Attribute (See "Attribute-Type Conditions")
Description	Optional.

After the container is added it is displayed on the Condition tab as shown in Figure 25-18. The Name, Type, and Description are displayed in the Results table at the top of the tab. The lower panel contains the details of the condition

Figure 25-18 Condition Containers on the Authorization Policy Page

Name	Type	Description
AttrCond1	Attribute	
TRUE	True	This condition always evaluates to true.

See Also:

["Defining Authorization Policy Conditions"](#) for information and procedures

25.10.1.2 Choosing a Condition Type

Users with valid Administrator credentials can choose a condition class for the authorization policy.

Note:

You can have more than one instance of a given class of condition in a policy.

Prerequisites

The Application Domain must exist.

See Also:

["Condition Window and Elements "](#)

To choose a condition class

1. Locate the desired policy as described in ["Searching for an Authorization Policy "](#).
2. Click the policy name to open its configuration.
3. On the individual policy page, click the **Conditions** tab.
4. Click the **Add (+)** button and ([Table 25-12](#)):
 - Name: Enter a unique name.
 - Type list, choose the kind of condition (Identity, for example).
 - Click the Add Selected button.
5. Proceed to one of the following topics to complete your definition:
 - [Defining Identity Conditions](#)
 - [Defining IP4 Range Conditions](#)
 - [Defining Temporal Conditions](#)
 - [Defining Attribute Conditions](#)

25.10.2 Defining Identity Conditions

This section provides all information about Identity Conditions in the following topics:

- [About Identity Conditions](#)
- [Specifying Identity Type Conditions](#)

25.10.2.1 About Identity Conditions

When defining an Identity Condition, you must add one or more members of a user population from one or more User Identity Stores.

You can add the user population as a list of users or groups. Alternatively, you can add LDAP search filters to be used at runtime to identify the user population. LDAP search filters provide a simple way to specify a target identity population without having to reorganize or create new groups in the identity store (directory server). For details see:

- [Identity Conditions and User Populations](#)
- [LDAP Search Filter Support in Identity Conditions](#)
- [LDAP Search Filter Syntax](#)

25.10.2.1.1 Identity Conditions and User Populations

After opening the condition container, any defined user population is displayed. As with the other condition types, the Identity type can be used in conjunction with identity and temporal conditions.

When adding an identity condition, you open the popup menu beside the Add (+) button (labeled 1 in [Figure 25-19](#)), choose to Add Users and Groups or Add Search Filter (2). [Figure 25-19](#) shows the popup menu and the Add Identities window that appears (3). After locating the desired identities, select the desired Identities and click Add Selected (4).

Figure 25-19 Add Identities Window

Search and select users and/or groups to add to the current condition.

Search

Store Name: UserIdentityStore1

Entity Type: Group

Entity Name: Administrators

Search Reset

View ▾

Entity Name	Entity Type	Store Name	Distinguished Name
Administrators	Group	IDSPROFILE-id...	cn=Administrators,ou=groups,ou=myrealm,dc=base_d...
OMSM_ADMINI...	Group	IDSPROFILE-id...	cn=OMSM_ADMINISTRATORS,ou=groups,ou=myrealm...

Columns Hidden 1

Add Selected Cancel

Table 25-13 describes the Add Identities elements.

Table 25-13 Add identities Elements

Element	Description
Store Name	Select the desired LDAP store for this search from the list of registered LDAP stores.
Entity type	Choose either Users, Groups, or All to define your search criteria.
Entity Name	Enter information to further refine your search criteria.
Search	Click this button when your search criteria are defined.
Results table	Displays the results of your search.
Add Selected	Click to add the selected users or groups from the results table to the Condition's Details.

After selecting one or more identities and clicking the **Add Selected** button, your Conditions tab might look something like [Figure 25-20](#).

Figure 25-20 Identity Condition and Details

Condition Details : IDCond1		
View	+ Add	Edit Delete
Entity Name	Entity Type	Store Name
Administrators	Group	IDSPROFILE-idxuserrole

To save these details as a condition, click the Save button in the upper-right corner of the tab.

25.10.2.1.2 LDAP Search Filter Support in Identity Conditions

Access Manager 11g authorization conditions accept a list of users, groups, and LDAP search filters as part of allowed or denied identities. An LDAP filter is a text string that expresses specific criteria for the search operation. LDAP search filters provide a simple way to specify a target population without reorganizing or creating new groups in the identity store (directory server).

Access Manager 11g accepts LDAP search filter data for the following conditions and resource types:

- Identity Conditions
- Token Requestor Identity Conditions
- All resource types (HTTP, TokenServiceRP, and other custom resource types)

When a user tries to access a resource protected by a condition containing an LDAP search filter, Access Manager performs a directory lookup (LDAP search) on the identity domain (identity store) specified as a part of the filter. Search results are cached to avoid repeated directory server lookups.

If you choose `Add Search Filter ...`, the controls shown in [Figure 25-21](#) appear. You can add more than one LDAP Search Filter in an authorization rule for evaluation at runtime. The field where you enter your LDAP search filter is used to identify allowed/denied users.

Figure 25-21 Add Search Filter Controls

Table 25-14 describes elements associated with adding a Search Filter.

Table 25-14 Add Search Filter Elements

Element	Description
Domain	The Identity Domain (registered user identity store) in which the search should be conducted during runtime. Each filter must be associated with a specific user identity store. With Access Manager 11g, a directory lookup (LDAP Search) is performed only on the specified identity domain (identity store).
Search Filter	The field where you enter your LDAP search filter. For example: <code>((dept=sales)(dept=support))</code> See Also: " LDAP Search Filter Syntax "

Table 25-14 (Cont.) Add Search Filter Elements

Element	Description
Test Filter	This button enables you to test your LDAP Search Filter to ensure it returns the expected result.
Test Results	The results of your filter test are displayed with your own designations for: <ul style="list-style-type: none"> Type: LDAPSearchFilter Identifier: Your LDAP Search Filter
Add Filter	Click to Add the filter to this identity condition.
Cancel	Click to dismiss the Add Search Filter dialog without adding a filter.

[Figure 25-22](#) shows the Identity Conditions: Details page, displayed after adding an LDAP Search Filter.

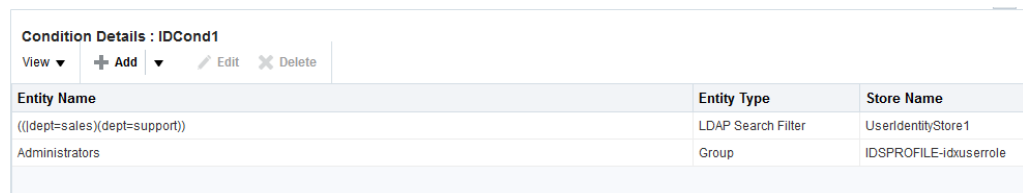
Figure 25-22 Identity Conditions: Details

Condition Details : IDCond1		
View ▾	+ Add ▾	Edit ✎ Delete ✕
Entity Name	Entity Type	Store Name
((dept=sales)(dept=support))	LDAP Search Filter	UserIdentityStore1
Administrators	Group	IDSPROFILE-idxuserrole

See Also:

- ["LDAP Search Filter Syntax"](#)
- ["Defining Identity Conditions"](#)

25.10.2.1.3 LDAP Search Filter Syntax

Only standard LDAP attributes can be used when defining an LDAP search filter. Exact syntax depends on your identity store; see your vendor documentation.

[Table 25-15](#) illustrates LDAP Search Filter examples for Access Manager.

Table 25-15 LDAP Search Filter Examples for Access Manager

Filter Type and Operators	Description	Syntax Example
Static LDAP Search Filters	<p>When you implement a static search filter, all search results must match a fixed value. For example, you can restrict a search to return only people whose directory profiles show an organizational unit of Sales.</p> <p>As an example of a simple static filter, suppose you want to provide Selector searches for the seeAlso attribute. The filter returns search results that show only people whose directory profiles contain a businessCategory value of dealership.</p>	<p>(attribute=value)</p> <p>For example:</p> <p>(businessCategory=dealership)</p>
Static Searches Using Wild Cards	<p>As an example of a static filter that uses wild cards, suppose you want only people with the word Manager in their title to be returned on a search using the Selector. You can create a filter that searches for the string Manager with the asterisk (*) wildcard.</p>	<p>(attribute=*value*)</p> <p>For example:</p> <p>(title=*manager*)</p>
Dynamic LDAP Search Filters	<p>A dynamic filter allows a search to return results that are based on a user profile. A dynamic filter is a conventional LDAP search filter with filter substitution syntax.</p>	<p>(attribute=\$attribute\$)</p>
Substitution syntax	<p>Substitution syntax is evaluated dynamically, according to the person executing a task. For instance, you can enter substitution syntax where the attribute value for the source DN (the person logged into the application) is substituted and evaluated against the target DN (the entry you are trying to view).</p> <p>Note: Setting a searchbase can present significant administrative overhead. A filter-based approach accomplished by substitution syntax can provide the same functionality in a more scalable and simplified design.</p> <p>Using substitution syntax, you can create a function that starts searches higher in the directory structure, but filters the search data by comparing an attribute of information from the search initiator's record (for example, using the substitution \$ou\$) to an attribute of data on each possible result (for example, ou=). You can use substitution syntax for attribute access control and searchbases. For example, by placing a filter on the type attribute Login for inetOrgPerson, the ability of a user to view any records outside their scope is removed.</p> <p>Note: For the selected searchbase, users can search only for entries from the same ou as their own. This applies only to the attribute on the person's record, not the ou of the branch of the directory in which they reside. Additionally, users from ou=people can search for entries within the selected searchbase.</p>	<p>(attribute=\$attribute\$)</p> <p>For example: The following filter finds all those in the same organizational unit as the person logged in to the application:</p> <p>(ou=\$ou\$)</p>

Table 25-15 (Cont.) LDAP Search Filter Examples for Access Manager

Filter Type and Operators	Description	Syntax Example
Dynamic Searches Using Wild Cards	Wildcards are supported in a dynamic filter. For example, suppose you want to supply a contactPerson attribute in an organizationalUnit object. The contactPerson attribute should return people in same Zip code as the organizationalUnit object. If the organizationalUnit profile contains an attribute zipCode, and the Zip code is specified at the end of a postalAddress directory attribute.	(attribute=*\$attribute\$) For example: (postalAddress=*\$zipCode\$)
Searches Using the Not Operator: (!)	The Not operator is supported when constructing a filter. The optimized algorithm causes the filter !(sn=white) to not give the expected result.	((!(sn=white)) (objectclass=personOC))

See Also:

["Specifying Identity Type Conditions"](#)

During migration to Access Manager 11g (from 10g), each LDAP Rule maps to corresponding 11g identity domains (user identity stores) based on Oracle Access Manager 10g directory profiles. Access Manager 11g identity domains (user identity stores) must be associated with each LDAP search filter.

See Also:**25.10.2.2 Specifying Identity Type Conditions**

Users with valid Administrator credentials can add identity type conditions to an Application Domain.

Note:

You must save each condition definition individually, before adding or selecting another condition.

Prerequisites

The Application Domain must exist.

See Also:

- ["About Identity Conditions"](#)
 - ["LDAP Search Filter Support in Identity Conditions"](#)
-

To add identity conditions to an authorization policy

1. Locate the desired policy as described in "[Searching for an Authorization Policy](#)".
2. Click the **Conditions** tab, click the Add (+) button.
3. Enter a **Name**, select **Identity** from the **Type** list (or Token Requestor Identity) and click **Add Selected**.
4. **Add Users/Groups:**
 - In the Condition Details section click the **Add (+)** button.
 - Choose **Add Users and Groups** from the list.
 - Store Name: Choose the desired name from the list of registered LDAP stores.
 - Enter criteria (Identity Type and Identity Name) for the population you want to find, and click the Search button.
 - Select desired results.
 - Click **Add Selected**.
 - Repeat to add another User or Group condition.
5. **Add Search Filter:**
 - In the Condition Details section click the **Add (+)** button.
 - Domain Name: Choose the desired user identity store for this filter.
 - Search Filter: Enter your search filter syntax ([Table 25-14](#)).
 - Test: Click the Test Filter button and review the results table.
 - Click the **Add Selected** button.
 - Repeat to add another LDAP Search Filter condition.
6. Click **Apply** and then close the Confirmation window.
7. Close the page when you finish.
8. Verify the Conditions by logging in as different users and test access to the resource.

25.10.3 Defining IP4 Range Conditions

This section provides the following information:

- [IP4 Range Condition Types](#)

- [Defining IP4 Range Conditions](#)

25.10.3.1 IP4 Range Condition Types

With the IP4 Range condition type, Administrators can specify a list of IP address ranges that will either be allowed or denied access. Like the other authorization conditions, IP4 Range condition types can be used in conjunction with identity and temporal conditions.

Explicit Addresses: Each IP address you specify must be an explicit, valid address (format *nnn.nnn.nnn.nnn*): *192.2.2.2*, for example.

Note:

Oracle Access Manager 10g accepts a wildcard as the last entry (*192.2.2.** or *192.2.**, for example). IP4 Ranges with no wildcards can be easily ported to 11g by creating a Condition containing multiple IP4 Range values. However, 10g IP4 Ranges with wildcards are expanded by upgrade tooling into multiple ranges relevant to the wildcard.

IP4 Range: You define a range by entering `From` (start) and `To` (end-range) address values. Each IP address you specify must be an explicit, valid address (format *nnn.nnn.nnn.nnn*): *192.2.2.2*, for example. The address specified in the `To` field should be greater than the address specified in the `From` field. During authorization, Access Manager checks to ensure that the client IP address falls between the `From` (start) and `To` (end-range) addresses specified. If multiple overlapping ranges are specified, and the client's IP address falls within even one of the ranges, the condition evaluates to "true" and allows (or denies) access based on the condition that was set for the condition.

If multiple overlapping ranges are specified, and the client's IP address falls within any one of the ranges, the condition evaluates to "true" and allows (or denies) access based on the condition.

Note:

If the `From` IP address is greater than the `To` address, the condition cannot match any client IP address.

[Figure 25-23](#) illustrates the IP4 Range Conditions table with a sample starting and ending IP4 Range. If you enter an invalid range, you are notified and unable to save it.

Figure 25-23 IP4 Range Conditions

ESSOReauthAuthzpolicy Authorization Policy Duplicate Apply

Authorization policy contains a set of conditions that define whether a user should be permitted or denied access to the resources protected by the policy. Authorization rules and conditions apply to all resources within a specific Authorization policy.

Summary Resources **Conditions** Rules Responses

View ▾ + Add ✎ Edit ✕ Delete

Name	Type	Description
AttrCond1	Attribute	
IDCond1	Identity	
IPRange1	IP Range	
TRUE	True	This condition always evaluates to true.

Condition Details : IPRange1
IP Ranges

View ▾ + Add ✎ Edit ✕ Delete

From	To
10.0.0.1	10.0.0.128

25.10.3.2 Defining IP4 Range Conditions

Users with valid Administrator credentials can add IP4 Range type conditions to an Application Domain. You must save each condition definition individually, before adding or selecting another condition.

Note:

If the user's IP address falls outside the range of denied addresses, this by itself is not enough for authorization to be successful. For authorization to be successful, the user must specifically be granted access based on an Allow rule.

Prerequisites

The Application Domain must exist.

See Also:

["IP4 Range Condition Types"](#)

To add IP4 Range type conditions to an authorization policy

1. Locate the desired policy as described in "[Searching for an Authorization Policy](#)".
2. Click the **Conditions** tab, click the **Add (+)** button.
3. Enter a **Name**, select **IP Range** from the **Type** list, enter an optional Description, and click **Add Selected**.
4. Add the desired IP address range ([Figure 25-23](#)):
 - In the Details panel, click the **Add (+)** button to display the Add IP Range dialog.
 - **From**: Enter the start of the range.

- To: Enter the end of the range.
 - Click the **Add** button to include this range in the Condition Details section.
 - Repeat these steps to add another range.
5. Click **Apply** and then close the Confirmation window.
 6. Verify your IP4 Range Conditions by logging from different clients with different IP addresses to test access to the protected resource.

25.10.4 Defining Temporal Conditions

This section provides the following topics:

- [Temporal Conditions](#)
- [Defining Temporal Conditions](#)

25.10.4.1 Temporal Conditions

With the Temporal condition type, Administrators must add the start and end time and the range of days. Like the other conditions, this one can be used in conjunction with identity and IP4 Range conditions.

By default, all days in the range are enabled (though none are checked in the form as shown in [Figure 25-24](#)).

Figure 25-24 Temporal Condition Type Details Page

ESSOReauthAuthzpolicy Authorization Policy Duplicate Apply

Authorization policy contains a set of conditions that define whether a user should be permitted or denied access to the resources protected by the policy. Authorization rules and conditions apply to all resources within a specific Authorization policy.

Summary Resources **Conditions** Rules Responses

View ▾ + Add Edit Delete

Name	Type	Description
AttrCond1	Attribute	
IDCond1	Identity	
IPRange1	IP Range	
Temporal1	Temporal	

Condition Details : Temporal1 Edit

Start Time

End Time

Monday Tuesday Wednesday Thursday Friday Saturday Sunday

Time periods must be specified in the HH:MM:SS (hour, minute, and second) format based on a 24-hour clock based on Greenwich Mean Time (GMT). Midnight is specified as 00:00:00 (start). The day ends at 24:59:59.

Table 25-16 Temporal Condition Details

Elements	Description
Start Time Notes: Time is specified using a full 24-hour range. For instance, midnight is specified as 00:00:00 and 11:00 PM is specified as 23:00:00.	Specifies the hour, minute, and second that this condition begins. Notes: Time is based on Greenwich Mean Time (GMT). GMT is the same all year with no adjustments for daylight savings time or summer time.
End Time	Specifies the hour, minute, and second that this condition concludes.
Days	Specifies the days where this policy is active. Default: All Days (even though these are not checked).

Save the details before closing this page.

See Also:

["Defining Temporal Conditions"](#)

25.10.4.2 Defining Temporal Conditions

Users with valid Administrator credentials can add temporal type conditions to an Application Domain.

Note:

You must save each condition definition individually, before adding or selecting another condition.

Prerequisites

The Application Domain must exist.

See Also:

["Temporal Conditions"](#)

To add temporal conditions to an authorization policy

1. Locate the desired policy as described in ["Searching for an Authorization Policy"](#).
2. Click the Conditions tab, click the **Add (+)** button.
3. Enter a **Name**, select **Temporal** from the **Type** list, enter an optional Description, and click **Add Selected**.
4. In the Details panel ([Table 25-16](#)): Click the condition name in the table to open the details panel:

- Enter the Start time.
 - Enter the End time.
 - Click the days of the week to which this condition applies (or leave all blank to specify every day of the week).
 - Click **Save**.
5. Click **Apply** and then close the Confirmation window.
 6. Verify the Temporal Conditions by logging in at different times to validate access to the protected resource.

25.10.5 Defining Attribute Conditions

This section provides the following topics:

- [Attribute-Type Conditions](#)
- [Defining Attribute Type Conditions](#)

25.10.5.1 Attribute-Type Conditions

An attribute-type condition enforces the evaluation of request context, user session state and user attributes for Allow or Deny access pertaining to all resource types and authorization policies in the Application Domain.

With an attribute-type condition defined, access is based on a list of name-value pairs scoped by the:

- Request context: Information on the requested resource, the client making the request, and the policy that was matched during evaluation.
- Session: User Session details (pre-defined session attributes or a reference to an arbitrary session attribute) when the user has an established session.
- User: User attribute information (reference to a LDAP attribute). This condition is used to define a condition on a reference to a user's arbitrary LDAP attribute only. However, conditions based on userID or groupID are defined using Identity Conditions.

Attribute type conditions are required when access is based on one of the situations described in [Table 25-17](#).

Table 25-17 Access Conditions that Require Attribute-Type Conditions

When Access is based on ...	Description
Session attribute	A user is authorized to access the resource if the session attribute "Authentication level" is <i>xx</i> and Session Attribute "s1" = "v1" and Session Start Time = "xxx". See: Table 25-20
Requested resource	hostname and port number See: Table 25-19

Table 25-17 (Cont.) Access Conditions that Require Attribute-Type Conditions

When Access is based on ...	Description
User details	A user is authorized to access the resource if its "Empno" = "xxx" (department=sales, for example) See: Table 25-21
Token Issuance based on a session attribute	The Requester Partner can issue a token to the Relying Party if the claim contains an attribute "SessionActiveTime" = "15000". You define claims-based conditions of the Token Issuance policy based on the assertions created using session data.

An Administrator defining attribute type conditions enters data into fields for built-in attributes and known attributes. The attribute name can be entered in a text field or selected from a list of values. The condition to be executed is constructed using "AND" or "OR" conjunctions on the condition. [Figure 25-25](#) illustrates the Attribute Conditions page.

Figure 25-25 Attribute Conditions Page

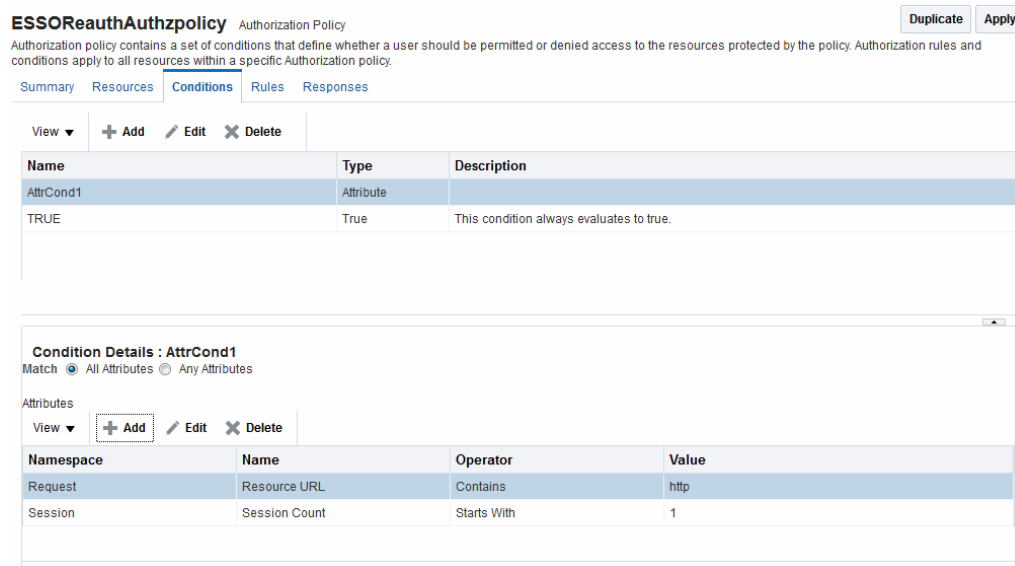

[Figure 25-26](#) shows the Add Attribute Condition dialog box. Each attribute condition is defined by the fields described in [Table 25-18](#).

See Also:

["Defining Attribute Conditions"](#)

Figure 25-26 Add Attribute Condition Dialog
Table 25-18 Attribute Condition Elements

Condition	Description
Namespace	Supported namespaces: <ul style="list-style-type: none"> Request Built-ins Session Built-ins Session (User Session) User (User Attributes)
Name	Attribute name, which can be added as follows, depending on the: <ul style="list-style-type: none"> Selected from a list if the Namespace is Request (Table 25-19) or Session (Table 25-20) Entered manually into a text field if the Namespace is User
Operator	Allowed operators: <ul style="list-style-type: none"> STARTS WITH EQUALS CONTAINS ENDS WITH
Value	Literal value with no special wildcard characters.

Request Built-ins

[Table 25-19](#) identifies the list of built-in attribute names for Request Built-ins:

Table 25-19 Attribute Names for Request Built-ins

Attribute Name	Description
agent_id	Name of the requesting agent.
client_ip	IP address of the user browser.

Table 25-19 (Cont.) Attribute Names for Request Built-ins

Attribute Name	Description
Policy_appdomain	Name of the Application Domain holding the policy matched for the request.
Policy_res	Resource host ID and URL pattern matched for the request.
policy_name	Name of the specific policy matched for the request.
res_host	Requested resource's hostname.
res_port	Requested resource's port number.
res_type	Requested resource's type.
res_url	Requested resource URL.

Session Built-ins

[Table 25-20](#) identifies the list of attribute names for Session-based attribute-type conditions.

Table 25-20 Attribute Names for Session Built-ins

Attribute Name	Description
Authentication Level	Current authentication level for the session.
Authentication Scheme	Name of the authentication scheme executed to achieve the current authentication level.
Session Count	Session count for the user bound to this session.
Session Creation Time	Session creation time.
Session Expiry Time	Session expiration time.

Example: Attribute Condition Data (Aggregation of Conditions)

[Table 25-21](#) illustrates sample condition data for each allowable namespace.

Table 25-21 Attribute Condition Data (Aggregation of Conditions)

Namespace	Name	Operator	Value
Request-Builtins	Res_host	Equals	7777
Session-Builtins	Authn_level	Equals	2
Session	<i>Sessionattr1</i>	Contains	Foo
User	<i>department</i>	Equals	sales

25.10.5.2 Defining Attribute Type Conditions

Users with valid Administrator credentials can add attribute type conditions to an Application Domain.

Note:

You must save each condition definition individually, before adding or selecting another condition.

Prerequisites

The Application Domain must exist.

See Also:

["Attribute-Type Conditions"](#)

To add attribute type conditions to an authorization policy

1. Locate the desired policy as described in ["Searching for an Authorization Policy"](#).
2. Click the **Conditions** tab, click the **Add (+)** button.
3. Enter a **Name**, select **Attribute** from the **Type** list, enter an optional Description, and click **Add Selected**.
4. **Add Details for Attribute Condition:** Click the name of the condition to expand the details panel, and:
 - Match: Click either All or Any.
 - Namespace: Select from the list ([Table 25-18](#)).
 - Name: Select from the list or enter manually ([Table 25-19](#) or [Table 25-20](#)).
 - Operator: Select from the list ([Table 25-18](#)).
 - Value: Enter manually ([Table 25-21](#)).
 - Click **Save**.
 - Repeat as needed.
5. Click **Apply** and then close the Confirmation window.
6. Verify the Attribute Conditions by logging in with different scenarios.

25.10.6 Viewing, Editing, or Deleting Authorization Policy Conditions

Users with valid Administrator credentials can add identity type conditions to an Application Domain.

Prerequisites

The Application Domain and authorization policy exist.

See Also:

["Introduction to Authorization Policy Rules and Conditions"](#)

To view, edit, or delete authorization policy conditions

1. Locate the desired policy as described in "[Searching for an Authorization Policy](#)".
2. Click the **Conditions** tab.
3. **Edit Condition Details:** Click the desired condition, click the Edit button to display the Details panel. Depending on the condition type, perhaps only the Description can be edited.
 - "[Defining Identity Conditions](#)"
 - "[Defining IP4 Range Conditions](#)"
 - "[Defining Temporal Conditions](#)"
 - "[Defining Attribute Conditions](#)"
 - True: Click the name, click the Edit button; only the Description can be edited.
4. **Delete Conditions:** Click the condition to remove and click the Delete button on the Condition tab.
5. Click **Apply** and then close the Confirmation window.
6. Close the page when you finish.
7. Verify the Conditions by accessing the resource and evaluating the results.

25.11 Defining Authorization Policy Rules

When Allow access rules, Deny access rules, or both are specified and do not apply to a user, the user is not qualified by the rule, and is denied access to the requested resource by default.

To specify who is allowed or denied access to the resource, the rule can do the following:

- Identify the users by user name, role, or an LDAP filter whose criteria the user must satisfy.
- Stipulate the computers where users can access resources.
- Set a time period when the rule applies.

This section provides the following topics:

- [Authorization Policy Rules](#)
- [Expressions and Expression-Based Policy](#)
- [Defining Rules in an Authorization Policy](#)

25.11.1 Authorization Policy Rules

Rules are new constructs in the Access Manager 11g policy model. A Rule specifies how to combine condition evaluation outcomes. Each Rule also contains a rule effect (ALLOW or DENY), which determines the overall policy outcome.

Authorization rules define the actions to take during evaluation of the policy, conditions, and rules as well as what to do based on the outcome. There are three possible outcomes:

- **True (Allow access):** If the user meets the Allow access condition, the user qualifies for the Allow access part of the rule.
- **False (Deny access):** If the user meets the Deny access condition, the user qualifies for the Deny access part of the rule.
- **Inconclusive:** If the user satisfies neither the Allow access nor the Deny access conditions, the rule is said to be unqualified for that user. You can also think of this as the user not qualifying for the rule. If evaluation of a rule results in an unqualified user, the user is denied access to the resource based on that rule.

In some cases, a single authorization rule is all that is required to protect the resources of an Application Domain or a policy. You can configure a rule to identify who is allowed access to the resources it protects, who is denied access to them, and under what conditions these controls apply (for example, when they apply and from which computer). An authorization rule does not need to cover all users in its Allow access and Deny access conditions. Users who request access to a resource that is protected by the rule but do not qualify for any of the conditions are, by default, denied access to the resource.

For other cases, it may be necessary to configure multiple authorization conditions into rules to protect resources. You can impose complex conditions on different users. For example, you can define a rule that includes several authorization conditions, one or more of which a user must meet to qualify for access to a protected resource (or to qualify for denial of access to it). For example, you might require the user to meet two conditions—such as belonging to one group and using a computer assigned a specific IP address—to be granted access to the resource.

Oracle Access Management Console makes it easy for you to form expressions for an authorization rule. Conditions are declared outside of rules and are referenced within rules. Evaluation outcomes are combined in either Simple mode or Expression mode. [Figure 25-27](#) shows the Rules tab in an authorization policy.

Figure 25-27 Authorization Policy Rules Tab: Simple Mode

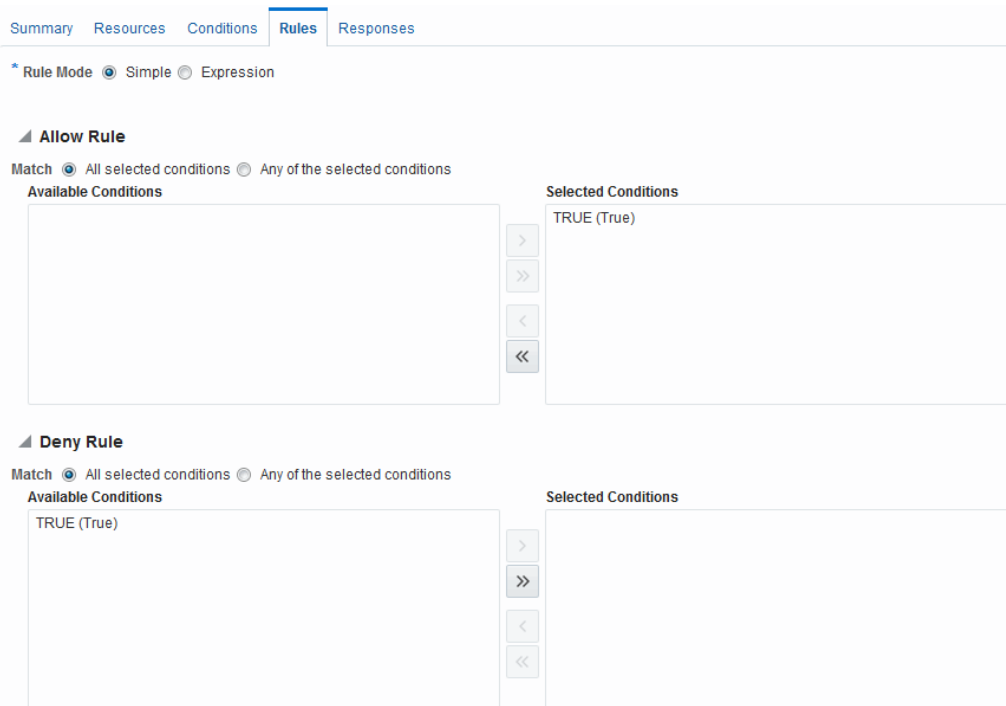

Table 25-22 describes the elements and controls on the Rules tab for Simple Mode evaluations.

Table 25-22 Authorization Policy Rules Elements

Element	Description
Rule Mode	<p>The method used for evaluation of conditions and rules:</p> <ul style="list-style-type: none"> Simple: Accepts a list of condition names that are combined using a simple algorithm: <ul style="list-style-type: none"> ALLOW conditions are combined using logical AND. All Allow conditions must be met to get access. DENY conditions are combined using logical OR. Any Deny condition that is true denies access. DENY always takes precedence over ALLOW. Expression: Accepts a user-specified Boolean expression to combine conditions using condition names, "(", ")", " ", "&" and "!" special characters. Combines conditions into complex policies. <p>See Also: "Expressions and Expression-Based Policy"</p> A policy in which there are one or more conditions that are not part of either Allow rule or Deny rule is treated as a valid policy.
Allow Rule	The rule that allows access based on evaluation of your rules and the Selected Conditions list.
Deny Rule	The rule that denies access based on the evaluation of your rules and the Selected Conditions list.

Table 25-22 (Cont.) Authorization Policy Rules Elements

Element	Description
Match	Criteria you choose to either match All conditions in the Selected Conditions list or Any conditions the Selected Conditions list.
Available Conditions	A list of all defined conditions for this authorization policy.
Selected Conditions	A list of the specific conditions that you build by moving items from the Available Conditions list to this list for use during the policy evaluation process.
Arrow Controls	Controls in the form of arrows enable you to add a condition to the Selected Conditions list (or vice versa to remove a condition from those selected).

25.11.2 Expressions and Expression-Based Policy

When a user requests access to a resource that is protected by an authorization condition and rule, information about the user is checked against the rule. If the condition stipulates other information, such as time period or time of day the condition applies, that, too, is checked. This process is referred to as *evaluation of the rule*.

An authorization expression consists of a single rule or a group of rules combined to express more complex conditions. For example, you can create an expression that requires a user to meet the Allow access conditions of two rules to be granted access to the resource. You use the Oracle Access Management Console to create these expressions, which include the following elements:

- Authorization conditions that you select from those that are defined and available in the authorization policy
- Operators that you use to combine rules to provide the kind of authorization protection that you want ([Table 25-24](#))

For expressions that contain multiple conditions, a user may qualify for none of the expression's conditions, one of the conditions, or for the conditions of multiple rules. In any case, it is the result of evaluation of the expression—all of its conditions and how they are combined—not any one condition, that determines whether a user is allowed or denied access to a resource.

About the Definitive Result of an Authorization Expression: Access Manager evaluates the rules of an expression until it can produce a definitive result. Evaluation of an authorization expression may produce a definitive Allow access result, a Deny access result, or an Inconclusive result.

[Figure 25-28](#) shows the Rules tab when you use Expression as a Rule Mode.

Figure 25-28 Rules Tab: Expression Rule Mode

Summary Resources Conditions **Rules** Responses

* Rule Mode Simple Expression

▲ Allow Rule

* Expression

Conditions ▼

▲ Deny Rule

* Expression

Conditions ▼

Table 25-23 describes the elements on the Rule tab in Expression mode.

Table 25-23 Rule Tab in Expression Mode

Element	Description
Rule Mode	<p>The method used for evaluation of conditions and rules:</p> <ul style="list-style-type: none"> Expression: Accepts a user-specified Boolean expression to combine conditions using condition names, "(", ")", " ", "&" and "!" special characters. Combines conditions into complex policies. A policy in which there are one or more conditions that are not part of either Allow rule or Deny rule is treated as a valid policy. <p>See Also: Table 25-24</p>
Allow Rule	The rule that allows access based on evaluation of your rules and the Selected Conditions list.
Deny Rule	The rule that denies access based on the evaluation of your rules and the Selected Conditions list.
Conditions	Provides a list of all conditions defined for this authorization policy.

Table 25-23 (Cont.) Rule Tab in Expression Mode

Element	Description
Insert Condition	Adds the selected Condition to the expression window.
Validate	Automatically tests the validity of the expression and reports results.

Table 25-24 identifies the operators you can use when building an authorization expression.

Table 25-24 Operators for Expressions in Authorization Rules

Operator	Description
()	<p>By default, two rules on either side of an AND operator compose the compound AND condition. Rules on either side of an OR operator are alternatives. When no parenthesis are used to enforce grouping of rules, the AND operator takes precedence over the OR operator.</p> <p>You can use parenthesis to override the default way in which the rules of an expression are grouped. Evaluation still occurs from left to right, but the rules are organized within the couplings and groups you create through use of parenthesis.</p>
&	<p>The AND operator, which you use to form a compound condition which combines authorization rules. Any number of rules can be combined using the AND operator to implement the full scope of conditions a user must meet to satisfy the authorization requirement. However, a user must satisfy the same kind of condition—either Allow Access or Deny Access—of all of the rules of the AND compound condition for the AND clause to produce a definitive result.</p> <p>An authorization expression can contain more than one coupling or grouping of rules combined using AND. For example, it may contain several AND clauses, one connected to another by an OR operator.</p>
	<p>The AND operator. An authorization expression can include a complex rule containing two or more alternative authorization conditions. Authorization rules forming a complex condition are combined using the OR operator. Each of the authorization rules specified by a complex OR condition stands on its own. Unlike compound conditions using the AND operator, the user need qualify for the condition of only one of the authorization rules connected by OR operators.</p> <p>An authorization expression can contain as many authorization rules connected using the OR operator as are required to express the authorization policy for the resources it protects. You can use the OR operator to connect authorization rules all of which have Deny Access conditions, all of which have Allow Access conditions, or which specify a mix of Deny Access and Allow Access conditions. You can connect single rules to single rules using OR, and you can connect a single rule to a clause containing rules combined using AND.</p>

25.11.2.1 Expression Evaluation in Authorization Rules

The result of evaluation of an authorization rule, in conjunction with other authorization rules, if more than one is included in the expression, determines if a user is granted access to the requested resource.

Evaluation of the rule occurs as follows:

- Each authorization rule specified in the expression is evaluated from left to right. The outcome is combined progressively with the previously evaluated rules.
- When the evaluation outcome is good enough to decide the overall policy outcome without having to evaluate any more rules, evaluation stops and the overall outcome is returned.
- Each evaluation outcome can be either True, False, or Inconclusive.

Authorization Success: In this case, the user succeeds in gaining access to the requested resource. This result is associated with the Allow Access condition of the expression.

Authorization Failure: In this case, the user fails to gain access to the requested resource. This result is associated with the Deny Access condition of the expression.

Authorization Inconclusive: In this case, the rules of the expression produce conflicting results, and the user is denied access to the resource. If the match for Identity, IP4 address, or timing condition fails then expression evaluation stops and the result of the overall evaluation is deemed Inconclusive. However, based on the other rules present in the expression, this result might not affect the overall policy evaluation.

For example, the following expression:

```
(Rule1 AND Rule 2) OR (Rule 3 AND Rule 4)
```

Yields the following outcomes:

- Rule1 - INCONCLUSIVE
- Rule2 - FALSE
- Rule3 - TRUE
- Rule4 - TRUE
- Overall: TRUE (Allow)

The following sample expression uses (in order of type) Identity, Temporal, IP4Range, and Attribute conditions:

```
(IsEMEAemployee & IsEMEAWorkingHours &      !((ConnectedOverVPN |NotReadDisclaimer))
```

Condition names that include spaces, tabs, or special characters (if properly escaped when defining the expression) are properly handled

25.11.3 Defining Rules in an Authorization Policy

Users with valid Administrator credentials can add rules to an authorization policy.

Prerequisites

[Defining Authorization Policy Conditions.](#)

See Also:

["Authorization Policy Rules "](#)

To define authorization policy rules

1. Locate the desired domain as described in "[Searching for an Authorization Policy](#)".
2. Click the **Rules** tab.
3. **Expression:**
 - a. Click **Expression** as the Rule Mode.
 - b. In the Allow Rule Expression field, build your expression by entering operators ([Table 25-24](#)) and choosing and inserting conditions ([Table 25-23](#)).
 - c. Click the **Validate** button to confirm your expression.
 - d. Repeat Steps b and c for the Deny Rule.
 - e. Click **Apply**.
4. **Simple Rule Mode:**
 - a. Click **Simple** as the Rule Mode.
 - b. **Allow Rule:**
Click to **Match** either:
 - All selected conditions
 - Any of the selected conditions

Using arrows for Allow (or Deny) Rule, move desired conditions from the Available Conditions column into the Selected Conditions column.

Click **Apply**.
 - c. Repeat step b for the Deny Rule.
5. Click **Apply** and then close the Confirmation window.
6. Verify the rules by accessing the resource and evaluating the results.

25.12 Configuring Policy Ordering

Previous releases of Access Manager used a policy matching algorithm to match incoming resource URLs with the stored patterns in an Application Domain. A best match is arrived at based on a predefined algorithm. (This algorithm can not be changed.) If multiple patterns are matched with an incoming URL, the best match pattern is selected and its associated policy is evaluated.

With this 11gR2 PS2 release, rather than the best match algorithm, an Administrator manually designates the order of policies within an Application Domain. To turn on Policy Ordering, the Administrator must first add one or more resource prefixes to the Application Domain. Once these have been added, you can click the Enable Policy Ordering flag. (See [Figure 25-2](#).)

Note:

You may create resource prefixes and not enable policy ordering. In this case, the resource prefixes are ignored and the best match algorithm is used.

Figure 25-29 is a screenshot of the Resource Prefix configuration pop up.

Figure 25-29 Adding a Resource Prefix for Policy Ordering

During runtime, the incoming URL of the protected resource is checked to determine if it starts with any resource prefix defined in the Application Domain. If the URL matches a resource prefix, the policies in the Application Domain configured with that resource prefix are checked (in the order defined by the Administrator) to see if any resource in the policy matches the incoming resource. If the incoming resource matches a particular policy, it is evaluated and the results are returned; the other policies are not checked.

To configure Policy Ordering

1. In the Oracle Access Management Console, click **Application Security** at the top of the window.
2. In the Application Security console, select **Create Application Domain** from the **Create (+)** drop-down menu
3. On the Create Application Domain page, add a unique name and an optional description.
4. Click **Add** to add a Resource Prefix.
5. Tick the **Enable Policy Ordering** box.
6. Select the Resource Type from the drop down list.

See [Table 25-1](#) for definitions of the default Resource Types.

7. Add an optional host identifier.

Host identifier is mandatory for an HTTP Resource Type.

8. Add the Resource Prefix.

For example, if the policy Resource being protected is /em/**, the Resource Prefix is /em. If the policy Resource being protected is /blog/**, the Resource Prefix is /blog.

9. Click **Add**.

25.13 Introduction to Policy Responses for SSO

Each policy can optionally contain one or more authentication or authorization responses, or both. Responses are post-processing actions (obligations) to be carried out by the web agent.

Note:

There are no responses in Token Issuance Policies.

This section provides the following information:

- [Authentication and Authorization Policy Responses for SSO](#)
- [About the Policy Response Language](#)
- [Namespace and Variable Names for Policy Responses](#)
- [About Constructing a Policy Response for SSO](#)
- [About Policy Response Processing](#)
- [Assertion Claims and Processing](#)

25.13.1 Authentication and Authorization Policy Responses for SSO

Administrators can define responses that declare the actions that must be fulfilled after successful authentication or authorization. Authentication and authorization data is returned to the client (typically a Web Agent).

Policy responses enable the insertion of information into a session or application and the ability to withdraw the information at a later time to enable SSO. For instance, identity mappings can be inserted into the customer's application or actions can be carried out by the Agent or the application.

Depending on the responses specified for authentication or authorization success and failure, the user might be redirected to a specific URL, or user information might be passed on to other applications through a header variable or a cookie value.

Note:

Oracle Access Manager 10g provided data passage to (and between) applications only by redirecting to URLs in a specific sequence.

There are no default response provided. [Figure 25-30](#) illustrates an Authorization Policy Response defined by an Administrator in the Oracle Access Management Console. Authorization responses can operate in conjunction with authorization conditions.

Figure 25-30 Authorization Policy Response in the Console

ESSOReauthAuthzpolicy Authorization Policy Duplicate Apply

Authorization policy contains a set of conditions that define whether a user should be permitted or denied access to the resources protected by the policy. Authorization rules and conditions apply to all resources within a specific Authorization policy.

Summary Resources Conditions Rules **Responses**

Identity Assertion

This will cause an assertion to be generated for the user, optionally containing any Asserted Attribute set below.

Responses + Add / Edit / Delete		
Name	Type	Value
REAUTH	Session	TRUE

Each response consists of two inputs (a type and an expression) and a single output (the value of the evaluated expression). The expression declares how the value should be constructed when the expression is processed. The response type defines the form of action to be taken with the value string.

- The authentication policy determines the identity of the user. Each authentication policy requires an authentication scheme and responses (expressions).
- The authorization policy determines whether the user has the right to access the resource. Each authorization policy requires authorization conditions and responses (expressions).

Response Guidelines

1. Cookie, Header, and Session responses are supported.
2. URL redirection can be set.
3. Response definitions are part of each policy. Response values can be literal strings or can contain additional embedded expressions that derive values from request, user, and session attributes.

Administrators set Responses in the Oracle Access Management Console, as described [Table 25-25](#).

Table 25-25 Response Elements

Element	Description
Name	A unique name to distinguish this response from other responses that use the same mechanism (type).

Table 25-25 (Cont.) Response Elements

Element	Description
Type	<p>The mechanism used to convey the response. form of the action to be taken with the value string:</p> <ul style="list-style-type: none"> • HEADER (Header variables): Sets an HTTP request header for downstream applications using the defined value to dictate the action to be taken (such as the assertion of a User ID using a pre-defined HTTP header name). Another example gets the subscriber information (realm DN and so on) for OSSO and creates a response during the upgrade; a fresh OSSO Agent requires manual configuration. • SESSION: Sets an attribute inside the user session by the client (to enable single sign-on) based on the defined session variable name and value. • COOKIE: Sets a variable name and value (typically set by Web agents) inside the authentication session cookie to enable single sign-on. In cookie-less mode, Web-cache is currently used to store cookies from Webgate. However, in cookie-less mode, the end application does not have access to cookies and cannot use them. • Asserted Attribute: With this type, Identity Assertion must be enabled for the policy to collect Assertion Attribute type responses when this policy is executed. The Name list provides valid identifiers from which to choose.
Value	<p>The response expression, set as a variable. For more information, see "About the Policy Response Language".</p>
Identity Assertion	<p>Identity Assertion is required for ID propagation for any issued token from Access Manager that represents an end user (and possibly its Access Manager session).</p> <p>Security Token Service clients that are Web applications protected by Access Manager requesting tokens to gain proxy access to a Relying Party (ID Propagation use case) are required to pass an Access Manager Identity Assertion token that represents the end user.</p> <p>The Identity Assertion Token is generated and returned as a policy response (HTTP HEADER named "OAM_IDENTITY_ASSERTION", value as a SAML token) after a successful authentication.</p> <p>As you add each (non-Asserted Attribute Type) Response, you might be informed that Identity Assertion has not been enabled for this policy. . . . Enable Identity Assertion to collect Assertion Attribute type responses when this policy is executed.</p> <p>See Also:</p> <ul style="list-style-type: none"> • "Scenario: Identity Propagation with the Access Manager Token" • "Authentication Policy Response for Identity Assertion by Webgate" • "Using Identity Context"

25.13.2 About the Policy Response Language

Access Manager authentication and authorization responses are defined using a very small, domain-specific language (DSL) with two main constructs.

- Literal strings: For example: `This is a valid expression`
- Variable references:

- Declared using a dollar sign prefix \$
- Scoped to a namespace: `$namespace.var_name`

Note:

Certain variables include an attribute: `$ns.name.attribute`

25.13.3 Namespace and Variable Names for Policy Responses

With the namespace mechanism, the following variable types are to enable single sign-on:

- Request: Information on the requested resource, the client making the request, and the policy matched during evaluation
- Session: User session details
- User: User details (user ID, group, and attribute information)

For details of each, see:

- [Table 25-26](#)
- [Table 25-27](#)
- [Table 25-28](#)

Table 25-26 *Namespace Request Variables for Single Sign-On*

Namespace	Description
agent_id	Name of the requesting agent
client_ip	IP address of the user browser
policy_appdomain	Name of the Application Domain holding the policy matched for the request
policy_eval_success_conditions	List of policy conditions that evaluated to true, separated by COLON or configured response separator
policy_eval_failure_conditions	List of policy conditions that evaluated to false, separated by COLON or configured response separator
policy_res	Resource host ID and URL pattern matched for the request
policy_name	Name of the specific policy matched for the request
res_host	Requested resource's hostname
res_port	Requested resource's port number
res_type	Requested resource's type
res_url	Requested resource URL path
res_complete_url	Requested resource URL path with query string

Table 25-27 Namespace Session Variables for Single Sign-On

Namespace	Description
attr	Reference to an arbitrary session attribute, the name of which is passed to us as a variable attribute. Its value has been bound to the session by executing a session response during a previous request.
authn_level	Current authentication level for the session
authn_scheme	Name of the authentication scheme executed to achieve the current authentication level
count	Session count for the user bound to this session
creation	Session creation time
expiration	Session expiration time

Table 25-28 Namespace User Variables

Namespace	Description
attr.<attrName>	Value of user attribute attrName. If attrName is multivalued, list of values, separated by COLON or configured response separator.
groups	List of user's group membership, separated by COLON or configured response separator.
userid	The user ID
user.id_domain	The user's identity domain (essentially the same as the identity store)
guid	A unique identifier that locates the user entry in an Identity Store

25.13.4 About Constructing a Policy Response for SSO

This section is divided as follows:

- [Simple Responses](#)
- [Compound and Complex Responses](#)
- [Multi-Valued Responses](#)

See Also:

[Guidelines for Authorization Responses Based on Conditions](#)

25.13.4.1 Simple Responses

After deciding on the response type and determining which namespace and variable, you simply enter the response attributes in the Oracle Access Management Console.

A simple response might look like one of the several authorization responses shown in [Figure 25-31](#).

Figure 25-31 Simple Response Samples

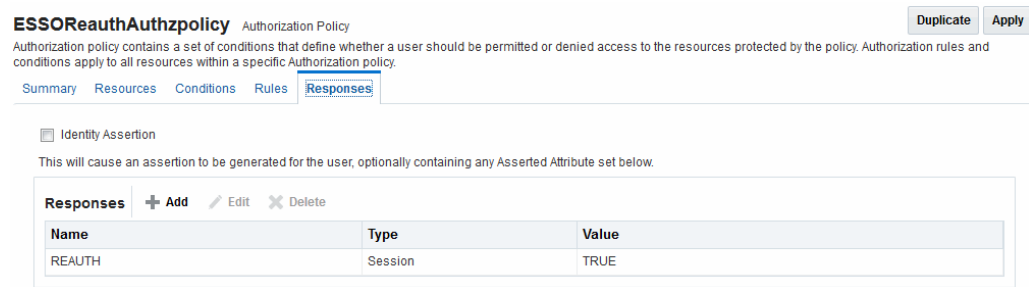

Simple responses stand alone. Each is preceded with the dollar sign (\$), followed by the namespace, which is separated from the variable Value by a dot (.). For example:

`$namespace1.var1`

[Table 25-29](#) illustrates several simple responses and a description of what each one returns.

Table 25-29 Simple Responses and Descriptions

Name	Type	Value (Simple \$Namespace.Variable)	Returned Environment Variables and Values
oam_sessioncount	Header	<code>\$session.count</code>	HTTP_OAM_SESSIONCOUNT <i>integer</i>
oam_userid	Header	<code>\$user.userid</code>	HTTP_OAM_USERID <i>name</i>
oam_ipaddress	Header	<code>\$request.client_ip</code>	HTTP_OAM_IPADDRESS <i>nnn.nn.nn.nnn</i>
oam_literal	Header	This is a response string.	HTTP_OAM_LITERAL <i>This is a response string</i>

25.13.4.2 Compound and Complex Responses

When crafting a compound or complex policy response, Administrators can combine literals and variables arbitrarily using braces { } to construct an expression. A colon (:) is used as a separator.

For example:

`${namespace1.var1}:${namespace2.var2}`

Literal String (LS): `${namespace1.var1}:${namespace2.var2}`

LS: `${namespace1.var1}, LS:${namespace2.var2}`

[Figure 25-32](#) illustrates several complex responses defined by an Administrator. All are Header type responses, which set values in a header variable of an HTTP request for consumption by a downstream application.

Figure 25-32 Complex Response Sample

Template Name	Type	Value
oam_resinfo	HEADER	Runtime resource: \${request.res_host}:\${request.res_port}\${request.res_url}
oam_clientinfo	HEADER	Runtime client: Agent ID: \${request.agent_id}, Browser IP: \${request.client_ip}
oam_userinfo	HEADER	\${user.userid}'s groups: \${user.groups}, description: \${user.attr.description}
oam_sessioninfo	HEADER	Session creation/expiration/count: \${session.creation}/\${session.expiration}/\${session.count}
oam_app_user	HEADER	\${user.userid}

Table 25-30 describes the complex responses shown in Figure 25-32.

Table 25-30 Complex Responses

Name	Value	Returned Environment Variables and Values
oam_resinfo	Runtime resource: \${request.res_host}:\${request.res_port}\${request.res_url}	HTTP_OAM_RESINFO Runtime resource: myhost.domain.com:1234/cgi-bin/myres3
oam_clientinfo	Runtime client: Agent ID: \${request.agent_id}, Browser IP: \${request.client_ip}	HTTP_OAM_CLIENTINFO Runtime client: Agent ID: RREG_OAM, Browser IP: 123.45.67.891
oam_userinfo	\${user.userid}'s groups: \${user.groups}, description: \${user.attr.description}	HTTP_OAM_USERINFO <i>WebLogic's groups: Administrators, description: This user is the default Administrator</i>
oam_sessioninfo	Session creation/expiration/count: \${session.creation}/\${session.expiration}/\${session.count}	HTTP_OAM_SESSIONINFO Session creation/expiration/count: Tue Oct 23 17:47:42 PST 2011/Wed Oct 24 01:47:42 PST 2011/7
oam_app_user	\${user.userid}	HTTP_OAM_USERID <i>name</i>

For more information, see "[About Policy Response Processing](#)".

25.13.4.3 Multi-Valued Responses

Access Manager 11g supports responses with multiple values. These can be multivalued user attribute responses, user's group membership responses and the like. For multivalued responses, Access Manager uses a COLON as the separator and a BACKSLASH as the escape character.

For example, if a user attribute `genType` has the values "Gold", "Platinum" and "Silver", the policy response for `user.attr.genType` would be:

```
"Gold:Platinum:Silver"
```

If a COLON appears in any of the attribute values, it will be escaped with BACKSLASH. For example, for a user with group memberships as "Administrators", "Special:Users", the policy response for `user.groups` would be

```
"Administrators:Special\:Users"
```

It is possible to change the default separator and escape character using the `configurePolicyResponses(responseSeparator, responseEscapeChar) WLST` command.

25.13.5 About Policy Response Processing

Policy response processing occurs during the authorization request for which the authentication responses are replayed. Variable references are filled with appropriate values to ensure that all variables have a value set, and can be set consistently with authorization values.

Processing a response expression is done through a series of steps:

- Scanner/tokenizer
- Parser
- Interpreter

During interpretation, variable references are resolved to values. The result after processing is a simple String value, which is propagated to the Agent or saved within the session for future use.

Authentication success responses are saved and then "replayed" along with any authorization responses on the first applicable authorization request.

Authorization response expressions create the actions to be taken, depending on the evaluation of the expression: success, failure, or inconclusive.

Note:

Oracle Access Manager 10g exhibits the same behavior in the "authenticating Webgate" configuration. This is also employed by Access Manager 11g with 10g Webgates: The 10g Webgate always redirects to the Access Manager 11g credential collector which acts like the authenticating Webgate.

When referencing a variable, either the value is returned, or the following is returned:

- NOT FOUND is returned if the variable is not set
- NULL is returned if the variable is set to a null value

Note:

Verify the Responses.

Pass Through Without Processing:

A value that must be passed through without processing, can be identified using a \. For example:

\\$1000

results in the value \$1000 appearing in the returned value.

25.13.6 Assertion Claims and Processing

For details, see [Using Identity Context](#) .

25.14 Adding and Managing Policy Responses for SSO

Policies and responses enable single sign-on and can override other directives.

Before starting activities in this section, be sure to review the "[Introduction to Policy Responses for SSO](#)".

Unless explicitly stated, information in this section applies equally to authentication and authorization responses.

- [Adding a Policy Response for SSO](#)
- [Viewing, Editing, or Deleting a Policy Response for SSO](#)

25.14.1 Adding a Policy Response for SSO

Users with valid Administrator credentials can add a policy response for authentication or authorization to the Protected Resource Policy.

For example, you can collect the DN of the realm that is created when Oracle Internet Directory is installed. Optionally, you can also configure the global user ID of the subscriber in Oracle Internet Directory or a subscriber name rather than the default company as shown in [Table 25-31](#).

Table 25-31 Fresh OSSO Installation: Protected Policy Response (Header)

Response Parameter	Collect Realm DN when OID is Installed	Configure GUID of Subscriber IN OID to Different Company	Configure GUID of Subscriber IN OID to Default Company
Name	<i>osso-subscriber-dn</i> (lowercase)	<i>osso-subscriber</i> (optional)	<i>osso-subscriber-guid</i> (optional)
Type	Header	Header	Header
Value	<i>dc=country,dc=example,dc=com</i>	<i>dc=country_or_region,dc=company</i>	<i>,dc=default_company,dc=company</i> Go to the subscriber DN (in Oracle Internet Directory for example) and find the value (of <i>orclguid</i> for the DN, for example).

Prerequisites

Analyze desired conditions before crafting authorization responses to ensure the appropriate actions are taken by the response. You need an Application Domain with an existing authentication or authorization policy.

See Also:

["Introduction to Policy Responses for SSO"](#)

To add a policy Response

1. Locate the desired domain as described in "[Searching for an Authorization Policy](#)".

2. In the individual policy page, click the **Responses** tab, then click the **Add** button and:
 - In the **Name** field, enter a unique name for this response.
 - From the **Type** list, choose a response type (Session or Header or Cookie).
 - In the **Value** field, enter a value for this response. For example:
\$namespace1.var1
-
- See Also:**
- ["Namespace and Variable Names for Policy Responses"](#)
-
- Repeat as needed.
 3. Click **Apply**, then close the Confirmation window.
 4. Close the page when you finish.
 5. Verify the Responses based on your definitions.

25.14.2 Viewing, Editing, or Deleting a Policy Response for SSO

Users with valid Administrator credentials can view or edit a policy response for authentication or authorization.

Prerequisites

You must have an Application Domain with an existing authentication or authorization policy.

See Also:

["Introduction to Policy Responses for SSO"](#)

To view, modify, or delete a policy response

1. Locate the desired domain as described in "[Searching for an Existing Application Domain](#)".
2. Click the Authentication (or Authorization) Policies tab, then click the desired policy name.
3. On the individual policy page, click the **Responses** tab and proceed as needed:
 - **Add:** See "[Adding a Policy Response for SSO](#)"
 - **Edit:** Click the desired Response Name, Type, or Value, edit as needed, and click Apply.
 - **Delete:** Click the desired response, then click the Delete button for the Response table.
4. Close the Confirmation window.
5. Close the page when you finish.

6. Verify Responses based on your definitions for:
 - Header
 - Session
 - Cookie: Use a browser plug-in tool or turn on the browser "show cookies" settings.
 - Assertion Claim

25.15 Validating Authentication and Authorization in an Application Domain

You can validate authentication and authorization by confirming you are redirected to the login page, and after sign-in redirected to the requested resource. The procedure here provides several methods for confirming that Agent registration and authentication and authorization policies are operational.

Prerequisites

- Users and groups who are granted access must exist in the primary LDAP User Identity Store that is registered with Oracle Access Management
- Agents must be registered to operate with Access Manager. After registration, protected resources should be accessible with proper authentication without restarting the Administration or Managed Server.
- Application domain, authentication policies, and authorization policies must be configured.
- Logout should be configured as described in [Configuring Centralized Logout for Sessions Involving 11g WebGates](#)

To verify authentication and access

1. Using a Web browser, enter the URL for an application protected by the registered Agent to confirm that the login page appears (proving that the authentication redirect URL was specified appropriately). For example:

```
http://exampleWebserverHost.example.com:8100/resource1.html
```

2. Confirm that you are redirected to the login page.
3. On the Sign In page, enter a valid username and password when asked, and click Sign In.
4. Confirm that you are redirected to the resource and proceed as follows:
 - **Success:** If you authenticated successfully and were granted access to the resource; the configuration is working properly.
 - **Failure:** If you received an error during login or were denied access to the resource, check the following:
 - Authentication Failed: Sign in again using valid credentials.
 - **Access to URL ... denied:** This userID is not authorized to access this resource.

- **Resource not Available:** Confirm that the resource is available.
- **Wrong Redirect URL:** Verify the redirect URL in the Oracle Access Management Console.

See Also:

[Validating Connectivity and Policies Using the Access Tester](#)

25.16 Understanding Remote Policy and Application Domain Management

Several remote management modes enable Administrators to update, or validate, or delete an existing agent registration.

This section provides the following topics:

- [Remote Policy Management Modes, Templates, and Flags](#)
- [Create Policy Request Template](#)
- [Update Policy Request Template](#)
- [Remote Policy Management Template Elements](#)

25.16.1 Remote Policy Management Modes, Templates, and Flags

Access Manager provides two modes to manage Application Domains and their policies without registering or modifying the companion agent. Remote policy and Application Domain management supports only create and update functions. Remote management does not support removing Application Domains or policies.

Note:

Application Domain removal is a manual task that must be performed using the Oracle Access Management Console.

[Table 25-32](#) describes these remote Application Domain management modes. Again, command parameters include the mode, and an input `*Request.xml` file using a relative path with respect to `$OAM_REG_HOME`, the preferred location for input files):

```
./oamreg.sh <mode> <input_file> [prompt_flag] [component.oam.config_file] <mode>
value
```

Table 25-32 Remote Policy Management Modes, Templates, and Flags

Mode and Template	Description
policyCreate \$OAM_REG_HOME/input/ <i>CreatePolicyRequest.xml</i>	Allows Administrators to create Host Identifiers and an Application Domain without registering an Agent. ./bin/oamreg.sh policyCreate input/ myCreatePolicyRequest.xml See Also: " Create Policy Request Template "

Table 25-32 (Cont.) Remote Policy Management Modes, Templates, and Flags

Mode and Template	Description
policyUpdate \$OAM_REG_HOME/input/ UpdatePolicyRequest.xml	Allows Administrators to update existing Host Identifiers and Application Domain without updating an Agent. ./bin/oamreg.sh policyUpdate input/ UpdatePolicyRequest.xml See Also: " Update Policy Request Template "
Flag	Optional
[prompt_flag] value: [- noprompt]	When the optional -noprompt flag is used, oamreg can read input from system.in by using echo and pipe to pass data. Examples from \$OAM_REG_HOME location: (echo username; echo password; echo webgate_password;) ./bin/oamreg.sh inband input/ Request.xml -noprompt component.oam.conf (echo username; echo password; echo webgate_password; echo httpscert_trust_prompt;) ./bin/oamreg.sh inband input/Request.xml -noprompt (echo username; echo password; echo webgate_password; echo cert_password;) ./bin/oamreg.sh inband input/ Request.xml -noprompt (echo username; echo password; echo webgate_password; echo httpscert_trust_prompt; echo cert_password;) ./bin/oamreg.sh inband input/Request.xml -noprompt

Table 25-32 (Cont.) Remote Policy Management Modes, Templates, and Flags

Mode and Template	Description
component.oam.config_file	<p>Optional. Remote registration accepts a configuration file with a URI list as an argument. component.oam.config_file defines the full path to a file containing any number of protected or public URIs. Ensure that the file uses the following syntax and format:</p> <ul style="list-style-type: none"> • At least one protected URI is required • Only one product family is allowed per file • Comments begin with '#' • Keyword 'public_uris': list public URIs on separate lines after this key word. • Keyword 'protected_uris': list URIs to be protected on separate lines after this key word <p>Note: You can configure the authentication scheme for a policy using the following format (the policy name and authentication scheme name must be separated by a Tab character):</p> <pre><Policy Name> 'tab' <Authentication Scheme Name></pre> <p>For example:</p> <pre>##### protected_uris ##### protected policy1 Basic Over LDAP /finance/protected1/** /finance/protected2/** protected policy2 Client Certificate /finance/protected3/*.js,*.png,*.gif ##### public_uris ##### /finance/public /finance/test1/public</pre>

25.16.2 Create Policy Request Template

The CreatePolicyRequest.xml file with the remote policyCreate mode allows Administrators to create Host Identifiers and an Application Domain without creating or updating an agent registration.

- Create a Host Identifier add multiple hostPortVariations (host port pairs).
- Create an Application Domain.
- Add multiple protected, public, and excluded resources. Resources can be with or without query strings, both are supported.
- Create default authentication and authorization policies for the resources that do not require customized policies.

Many of the same parameters are found in the `CreatePolicyRequest.xml` file and the expanded (full) Agent registration templates discussed earlier. `CreatePolicyRequest.xml` provides elements for Authentication and Authorization Policies and resources (with no `<agentName>` element).

Some parameters in the `CreatePolicyRequest.xml` file are new and not included in the full agent registration XML files, while certain elements in the original agent registration file are used to create or update. However, some elements are The primary differences of `CreatePolicyRequest.xml` are specific to:

- Elements for Authentication and Authorization Policies and resources are provided
- No `<agentName>` element or related elements are provided

See Also:

["Remote Policy Management Template Elements"](#)

25.16.3 Update Policy Request Template

`UpdatePolicyRequest.xml` and `CreatePolicyRequest.xml` are nearly identical. Both provide the same elements, with the exception of the `<protectedAuthnScheme>` element.

See Also:

["Remote Policy Management Template Elements"](#)

Using `UpdatePolicyRequest.xml`, Administrators can:

- Update a Host Identifier add multiple `hostPortVariations` (host port pairs)
- Update an Application Domain
- Add multiple protected, public, and excluded resources.(with or without query strings).
- Update default authentication and authorization policies for the resources that do not require customized policies
- Create customized policies that include:
 - Policy display name
 - Policy description
 - Authentication scheme (Authentication policies only)A subset of resources to be associated with the policy

25.16.4 Remote Policy Management Template Elements

This topic describes the unique remote management elements for Application Domain management found in the `CreatePolicyRequest.xml` and `UpdatePolicyRequest.xml` files.

These elements are described in [Table 25-33](#).

See Also:

[Table 15-8](#) for a description of elements common to remote registration and remote management.

Table 25-33 Remote Management Template Elements

Element	Description	Example
<code><rregAuthenticationPolicies></code> <code><rregAuthenticationPolicy</code> <code>></code>	Specifies the name and description for the Authentication Policy (to use when creating a new policy or updating an existing policy).	<pre> <rregAuthenticationPolicies> <rregAuthenticationPolicy> <name>AuthenticationPolicy1</name> <description>Authentication policy created using policyUpdate mode of rreg tool</description> . . </rregAuthenticationPolicy> </rregAuthenticationPolicies> </pre>
<code><authnSchemeName></code>	Specifies the Authentication Scheme to use in the Authentication Policy.	<pre> <rregAuthenticationPolicies> . . authnSchemeName>LDAPScheme </authnSchemeName> . . </rregAuthenticationPolicy> </rregAuthenticationPolicies> </pre>
<code><uriList></code>	Identifies a resource that requires authentication using the policy.	<pre> <rregAuthenticationPolicies> . . <uriList> - <uriResource> <uri>/res1</uri> <queryString /> </uriResource> </uriList> . . </rregAuthenticationPolicy> </rregAuthenticationPolicies> </pre>

Table 25-33 (Cont.) Remote Management Template Elements

Element	Description	Example
<pre><rregAuthorizationPolicies> <rregAuthorizationPolicy></pre>	Specifies the name and description for the Authorization Policy (to use when creating it anew or updating an existing policy).	<pre><rregAuthorizationPolicies> <rregAuthorizationPolicy> <name>AuthorizationPolicy1</name> <description>Authorization policy created using policyUpdate mode of rreg tool</description> . . </rregAuthorizationPolicy> </rregAuthorizationPolicies></pre>
<pre><uriList></pre>	Identifies a resource that requires Authorization using the Authorization Policy.	<pre><rregAuthorizationPolicies> . . <uriList> - <uriResource> <uri>/res1</uri> <queryString /> </uriResource> </uriList> . . </rregAuthorizationPolicy> </rregAuthorizationPolicies></pre>

25.17 Managing Policies and Application Domains Remotely

Administrators can create or update existing policies remotely, without revising an agent's registration.

Prerequisites

Review [Remote Policy Management Modes, Templates, and Flags](#)

To managing policies or an Application Domain remotely without an Agent

1. Set up the registration tool as described in, "[Acquiring and Setting Up the Remote Registration Tool](#)".
2. Copy the appropriate request template and develop your own policy-management request (including any Application Domain revisions needed):
 - Create Policy Request File
 - Update Policy Request File
3. On the Agent host, run the following command with the appropriate mode and your own *Request*.xml input file. For example:

policyCreate Mode:

```
./bin/oamreg.sh policyCreate input/myCreatePolicyRequest.xml
```

policyUpdate Mode:

```
./bin/oamreg.sh policyUpdate input/myUpdatePolicyRequest.xml
```

4. Provide the registration Administrator user name and password when asked.
5. Confirm success by reading on-screen messages, then use the Oracle Access Management Console to manage the domain and policies:

```
agentUpdate process completed successfully!
```

```
Native Configuration File Location: "... created in output  
folder ..."
```

The output folder is in the same location where RREG.tar.gz was expanded: .../
rreg/output/AgentName/

25.18 Application and Application-types

Application contains launch-url, icons, description, and other meta-data, and supports SSO agent, federation service provider partner and form-fill applications.

An Application contains:

- launch-url (that will be used by the end user of the application)
- icons, description and other meta-data that is used to display it in the Access Portal (which is user facing)

The following Application types are supported:

- SSO Agent Application (protected by a WebGate)
- Federation Service Provider Partner Application (through Federation, launch a third-party partner application)
- Form-Fill Application (Access Portal Application template based application)

The Application should have the configuration required to SSO enable it. However, for PS2, only Form-Fill application and Federation SP applications have their configuration in the Application. SSO applications have only the launch URL. Additional functionality will be added in subsequent releases.

Note:

Application registration will work only if ESSO is configured and enabled. In order to register an Application, an ESSO IDS Profile must be created because the Application's policy information is stored in the ESSO directory store.

Validating Connectivity and Policies Using the Access Tester

Oracle provides a portable, stand-alone Java application, Access Tester, which simulates registered Agents connecting to OAM Servers. The scripted execution allows for command-line processing. You can record and playback scripts and capture output for different functions. Encrypted and multiple-server connections are supported.

IT professionals and Administrators can use the Access Tester to troubleshoot agent to server connections in addition to on-the-fly testing of request and response semantics and access policy designs.

The following topics introduce the Access Tester and how to use it in the following sections:

- [Prerequisites to Using the Access Tester to Validate Connectivity and Policies](#)
- [Introduction to the Access Tester for Access Manager 11g](#)
- [Installing and Starting the Access Tester](#)
- [Access Tester Console, Navigation, and Controls](#)
- [Testing Connectivity and Policies from the Access Tester Console](#)
- [Creating and Managing Test Cases and Scripts](#)
- [Evaluating Scripts, Log File, and Statistics](#)

26.1 Prerequisites to Using the Access Tester to Validate Connectivity and Policies

Before you proceed with validation of connectivity and policies ensure the system level requirements are met.

Following are the requirements to perform tasks in this chapter:

- Ensure that the Oracle Access Management Console and OAM Server are running.
- Confirm the Application Domain and policies for one or more resources, as described in [Managing Policies to Protect Resources and Enable SSO](#).

26.2 Introduction to the Access Tester for Access Manager 11g

The Access Tester is a portable, stand-alone Java application that ships with Access Manager 11g. The Access Tester provides a functional interface between an individual IT professional or Administrator and the OAM Server.

IT professionals can use the Access Tester to verify connectivity and troubleshoot problems with the physical deployment. Application Administrators can use the Access Tester to perform a quick validation of policies. In this chapter, the term "Administrator" represents any individual who is using the Access Tester.

The Access Tester can be used from any computer having a network connection to the OAM Server. Both a graphical user interface (known as the Tester Console in this chapter) and a command-line interface are provided. Command line mode enables complete automation of test script execution in single or multi-client mode environments.

By appearing to be a real agent, the Access Tester helps with policy configuration design and troubleshooting, and sometimes with troubleshooting OAM Server responsiveness. When using the Access Tester, you must appear to be the real end user; the Access Tester does not actually communicate with a real end user.

To use the Access Tester, you must understand and administer authentication and authorization policies for an application or resource that is protected by Access Manager.

The Access Tester enables you to:

- Configure a request to be sent to the OAM Server that emulates what a real agent would send to the OAM Server in a real environment.
- Send your request to the OAM Server and receives a response that is the same as the response that would be received by a real Agent. The Access Tester uses the OAM Access Protocol (OAP) API to send requests over the OAP channel to the OAM Proxy running as part of the OAM Server. The OAM Server processes the request and returns a response.
- Process and display the server response.
- Proceed in the manner a real agent would to handle the response. For example, if a Webgate determines that a resource is protected by a certificate authentication scheme, then it must obtain the end user's certificate from the http SSL connection.

In the case of a certificate authentication scheme, you must point the Access Tester to a certificate to be used as the end user's credentials.

In addition to simulating the Agent while performing functions in the previous list, the Access Tester enables you to:

- Review performance characteristics of intended policy changes
- Track the latency of authentication and authorization requests
- Stress test the OAM Server to establish low- and high-performance watermarks relative to desired user loads, and to size back-end hardware
- Stress test the policy server by running multiple concurrent tests (multi-threaded mode) with command-line mode only.
- Establish performance metrics and measuring on an ongoing basis to prove desired outcomes

During basic operations, the Access Tester does not make any determination about the Server response and whether it is a right or wrong response (for instance, whether or not resource X is protected, or user Y is authorized to access resource X). When operating the Access Tester, you must be aware of the policy configuration to determine if a specific response is appropriate.

The Access Tester offers advanced functionality that enables you to group a number of individual requests into a test script that can be sent to the OAM Server for processing. The output of such a test run can be captured by the Access Tester and used to compare against a similar document containing "known good" responses. In this way, the Access Tester can be used for automated testing of policy configuration against errant changes.

Additionally, the Access Tester provides a multi-threaded capability designed to stress test the policy server. In the multi-threaded approach, you identify the number of virtual test clients to connect to the policy server and the number of iterations that each virtual client should execute a test script. This enables you to stress test the policy server.

For more information, see the following topics in this chapter:

- [About OAM Agent and Server Interoperability](#)
- [About Access Tester Security and Processing](#)
- [About Access Tester Modes and Administrator Interactions](#)

26.2.1 About OAM Agent and Server Interoperability

The two primary types of actors in the OAM architecture are the policy servers (OAM Servers) and OAM policy enforcement agents (Webgates or Access Clients). In the security world, Agents represent the policy enforcement point (PEP), while OAM Servers represent the policy decision point (PDP).

- The Agent plays the role of a gatekeeper to secure resources such as http-based applications and manage all interactions with the user who is trying to access that resource. This is accomplished according to access control policies maintained on the policy server (OAM Server).
- The role of the OAM Server is to provide policy, identity, and session services to the Agent to properly secure application resources, authenticate and authorize users, and manage user sessions.

This core OAM product architecture revolves around the following exchanges, which drive the interaction between the Agent and OAM Server. To expose inter-operability and the key decision points, [Figure 26-1](#) illustrates a typical OAM Agent and OAM Server interaction during a user's request for a resource.

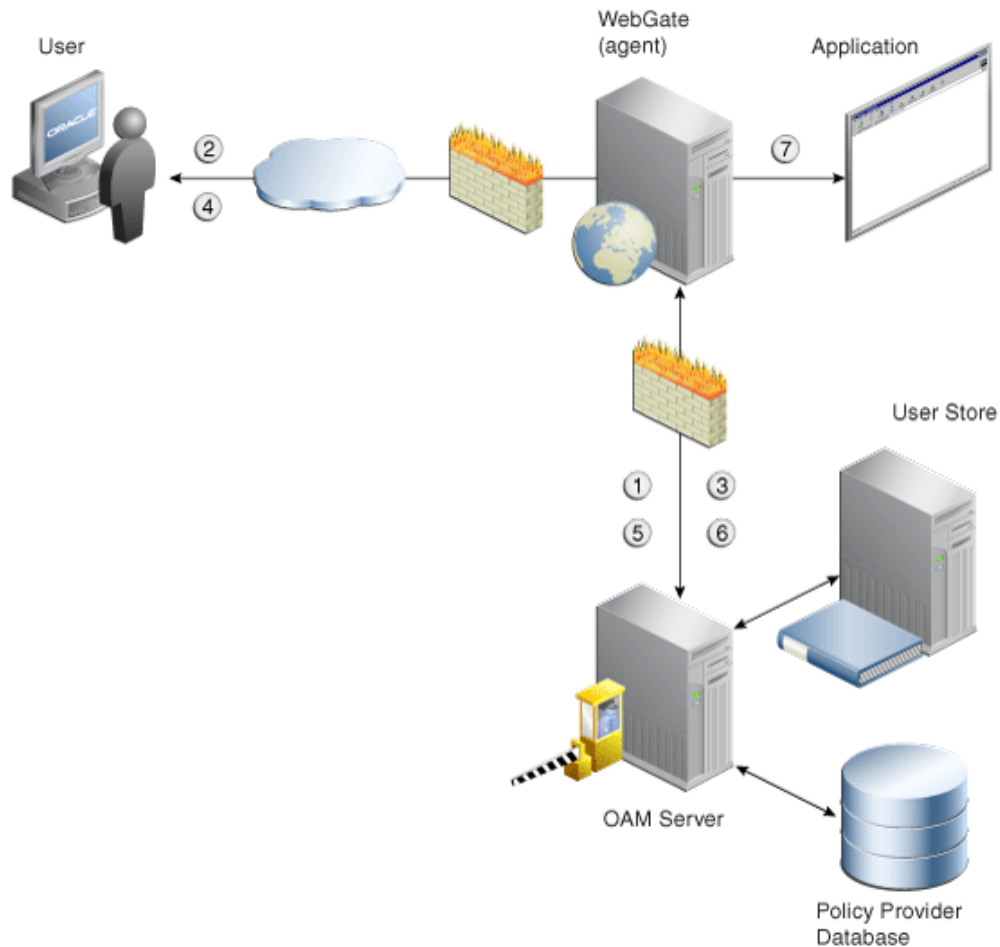
Figure 26-1 OAM Agent (PEP) and OAM Server (PDP) Inter-operability

The following overview outlines the processing that occurs between OAM Agents and OAM Servers. During testing, the Access Tester emulates the Agent and communicates with the OAM Server while the Administrator emulates the end user.

Process overview: Interoperability between OAM Agents and OAM Servers

1. Establish server connectivity: The registered OAM Agent connects to the OAM Server.
2. The user requests access to a resource.
3. Validate resource protection: The Agent forwards the request to the OAM Server to determine if the resource is protected.
Protected: The OAM Server responds with the type of credentials required.
4. User credentials: Establishing the user identity enables tracking for Audit and SSO purposes, and conveyance to the application. For this, the Agent prompts the user for his credentials.
5. Authenticate user credentials: The Agent forwards the supplied user credentials to the OAM Server for validation.
Authentication Success: The Agent forwards the resource request to the OAM Server.

6. Authorize user access to a resource: The Agents must first determine if the user is allowed to access the resource by forwarding the request for access to the OAM Server for authorization policy evaluation.
7. The Agent grants or denies access based on the policy response.

26.2.2 About Access Tester Security and Processing

This topic provides information about secure communications, connections, storage, input, logging, and Analysis.

Secure Communication: The Access Tester supports Open, Simple, or Cert connection modes for communication with the OAM Server:

- Open mode: No security on the physical connection
- Simple mode: The physical connection is encrypted using built-in certificates. With Simple mode, you are asked to enter the Global Pass Phrase that is configured for the OAM Server.
- Cert mode: The physical connection is encrypted using a field-provided certificates. Access Tester Cert Mode requires:
 - Configuring the agent (either existing or new) for Cert mode communication.
 - Obtaining certificates for the agent being emulated.

Access Tester Cert Mode requires two JKS key stores, created using the importcert tool from the supplied PEM (BASE64-encoded ASCII) certificates: aaa_trust.pem, aaa_key.pem, aaa_cert.pem:

- A Trust Store (file containing the JKS key store with the root CA certificate) is required.
- A Key Store (file containing the JKS key store with the agent's private key and certificate) is required.
- A Key Store Password is used to encrypt the Key Store with the agent certificates.

See Also:

- [Securing Communication](#) for details about Simple and Cert mode configuration for OAM Server and clients (Webgates)
 - "[Access Tester Console, Navigation, and Controls](#)"
-

Connections: The Access Tester encrypts all password-type values that it saves to configuration files and test cases. Access Tester validates whether the pool contains valid connections. Cache flush requests are sent over an established connection (not an out-of-band connection to delete the user session (to simulate logout) over OAP. Using an already established connection can improve performance.

Persistent Storage: The Access Tester manages a number of data structures that require persistent storage between Access Tester invocations. XML-file-based storage is provided for the following types of information:

- Configuration data to minimize data entry between invocations of the application (OamTestConfiguration)
- Test scripts consisting of captured test cases (OamTestScriptCase)
- Statistical data representing execution metric from a test run (OamTestStats)

XML Files for Input, Logging, and Analysis: The Access Tester uses a single XML schema to define all the XML documents it generates. The following XML files are produced when you run the Access Tester to process test scripts:

- Configuration Script: config.xml is the output file generated using the Save Configuration command within the Access Tester. The name of this document is used within the input script to provide proper connection information to the Access Tester running in command line mode. For details, see "[Saved Connection Configuration File](#)".
- Input Script: script.xml represents a script that is generated by the Access Tester after capturing one or more test cases. For details, see "[Generated Input Test Script](#)".
- Target Output Script: oamtest_target.xml is generated by running the Access Tester in command line mode and specifying the input script. For details, see "[Target Output File Containing Test Run Results](#)". For example: -
`Dscript.scriptfile="script.xml" -jar oamtest.jar`
- Statistics: oamtest_stats.xml is generated together with the output script. For details, see "[Statistics Document](#)".
- Execution Log: lamtest_log.log is generated together with the output script. For details, see "[Execution Log](#)".

For more information, see "[About Access Tester Modes and Administrator Interactions](#)".

26.2.3 About Access Tester Modes and Administrator Interactions

This topic describes modes, interactions, and the jar files needed to start and run the Access Tester.

Console: The Access Tester provides a single window for interactions with the user. All Access Tester operations are available in the main window, which performs as a central dashboard where users can submit specific details for the test case and view responses.

Command Line and Scripts: You can use the Access Tester command line and develop test scripts, which you can run interactively or in batches for computerized execution to maximize productivity and minimize costs and resources.

Startup and Run Time JAR Files: The Access Tester requires nap-api.jar in the same directory as the main jar oamtest.jar, which is used to start the application.

Interactions: Regardless of the mode you choose for running the Access Tester, your primary interactions with the Access Tester include:

- Issuing Requests and Reviewing Results

You use the Access Tester to issue requests to the OAM Server to validate resource protection, policy configuration, user authentication, and user

authorization. You can immediately analyze test case results and also retain the data for longer-term analysis, if needed.

- **Managing Test Scripts**

You can build test scripts by capturing the data generated by test execution, which is available as stand-alone documents. You can run the test script for manual or automated analysis. The Access Tester provides for some automated analysis after each test run, while collecting full set of statistics to enable analysis after the fact.

- **Managing OAM Server Connectivity**

You can manage application settings that include server connection information.

Figure 26-2 depicts the flow of information during operations in both Console and command-line modes. Details follow the figure. Advanced operations include building and executing test scripts.

Note:

Command-line mode enables complete automation of test script execution in single or multi-client mode environments. The Access Tester exposes a control mechanism to configure test runs without having to change "known good" input test scripts which are available in read-only mode.

Figure 26-2 User Interactions with the Access Tester

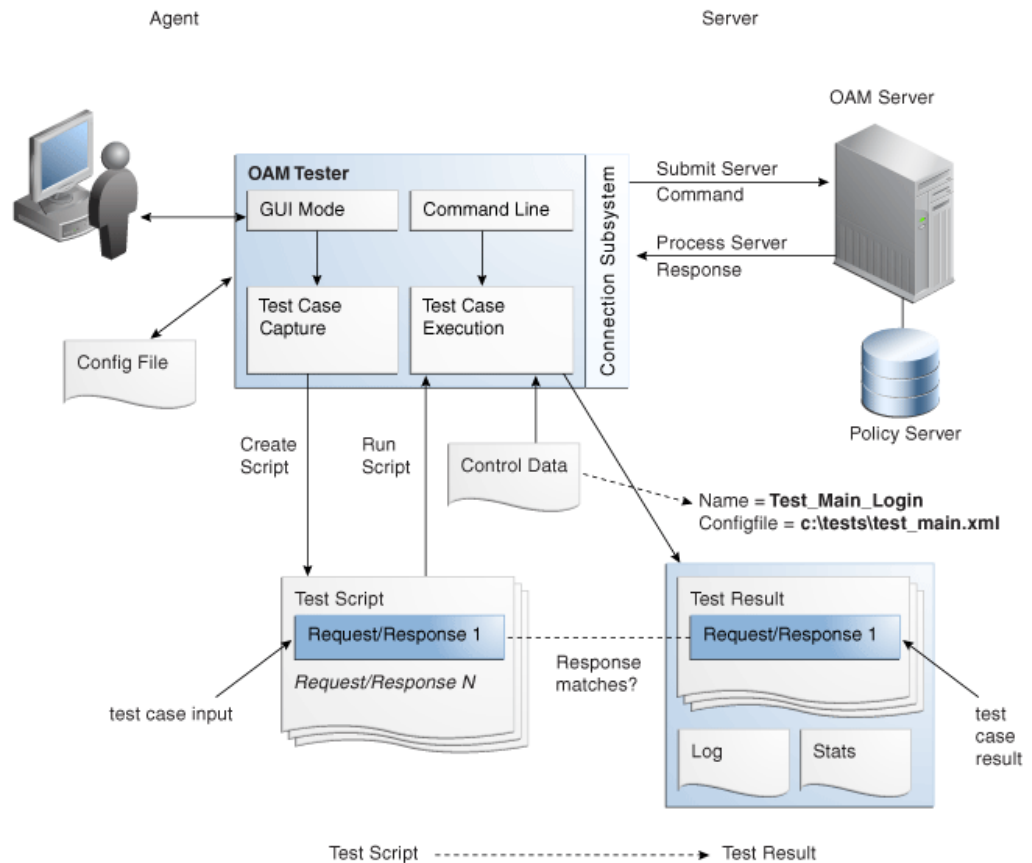

Table 26-1 describes the process flow of information during both Tester Console mode operations and command-line mode operations.

Table 26-1 User Interactions: Tester Console Mode versus Command Line Mode Operations

Tester Console mode	Command Line Mode
The user starts the Access Tester from the command line.	The user or a shell script starts the Access Tester in command line mode. Cert mode for secure communication: The keystores are specified in the OamTestConfiguration.xml file containing previously saved configuration information.
The user opens a previously saved OamTestConfiguration.xml file to populate the application fields and minimize data entry, including server connection fields. Alternatively , the user can use the Tester Console and enter data manually	The Access Tester starts processing test cases based on the input script.
The user clicks the Connect button to open the connection with the OAM Server.	The Access Tester opens a connection with the OAM Server based on details in the input script.
Resource Protection: The user performs steps in a sequence to validate resource protection, authenticate user credentials, and authorize user access.	Resource Protection: The Access Tester starts processing test cases based on the input script.
When the test completes, the Access Tester generates: <ul style="list-style-type: none"> • A script with results • A file with execution statistics including information about mismatched responses • A log file detailing processing flow 	Once the script completes, the Access Tester generates: <ul style="list-style-type: none"> • A script with results • A file with execution statistics including information about mismatched responses • A log file detailing processing flow
The user repeats steps as needed to complete validation	The user repeats steps as needed to complete validation.
In Cert mode, you will be prompted to identify the necessary keystores.	In Cert mode, the keystores are specified in the XML file containing previously saved configuration information.

The following overview outlines the tasks involved with using the Access Tester, and the topics where more information can be found in this chapter.

Task overview: Testing Access Manager connections and policies

1. Review the following topics:
 - [Installing and Starting the Access Tester](#)
 - [Access Tester Console, Navigation, and Controls](#)
2. Perform and capture tests using the Access Tester Console as described in "[Testing Connectivity and Policies from the Access Tester Console](#)"
3. Proceed to "[Creating and Managing Test Cases and Scripts](#)"

26.3 Installing and Starting the Access Tester

The Access Tester consists of two jar files that can be used from any computer, either within or outside the WebLogic Server domain. Installing the Access Tester, involves copying the Access Tester jar files to a computer from which you want to run tests.

The Access Tester must be started from a command line regardless of the mode you choose for test input: Tester Console mode or command line mode.

This section is divided into the following topics:

- [Installing the Access Tester](#)
- [System Properties Supported by the Access Tester](#)
- [Starting the Tester Without System Properties For Use in Tester Console Mode](#)
- [Starting the Access Tester with System Properties For Use in Command Line Mode](#)

26.3.1 Installing the Access Tester

This topic describes how to install the Access Tester for use on any computer.

Following installation, the Access Tester is ready to use. No additional setup is required.

To install the Access Tester

1. Ensure that the computer from which the tester will be run includes JDK/JRE 6. For example, you can test for Java as follows:

```
java -version
```

The previous command returns the following information:

```
java version "1.6.0_18"
Java(TM) SE Runtime Environment (build 1.6.0_18-b07)
Java HotSpot(TM) Client VM (build 16.0-b13, mixed mode)
```

2. On a computer hosting the OAM Server, locate and copy the Access Tester Jar files. For example:

```
$ORACLE_HOME/oam/server/tester/oamtest.jar
$ORACLE_HOME/oam/server/tester/nap-api.jar
```

3. Store the jar file copies together in the same directory on any computer from which you want to run the Access Tester.
4. Cert Mode: If the OAM Server communication mode is Cert, ensure that the computer from which you will run the Access Tester includes the same keystores that are defined on the agent registration page of the Oracle Access Management Console. See [Introduction to Agents and Registration](#).
5. Proceed as follows, depending on your environment and requirements:
 - [Starting the Tester Without System Properties For Use in Tester Console Mode](#) enables you to manually drive requests.
 - [Starting the Access Tester with System Properties For Use in Command Line Mode](#)
 - [Executing a Test Script](#) enables you to use a test script that has been created against a "Known Good" policy configuration and marked as "Known Good"

26.3.2 System Properties Supported by the Access Tester

The Access Tester supports a number of configuration options that are used for presentation or during certain aspects of testing. These options are specified at startup using the Java-D mechanism.

[Table 26-2](#) describes all supported system properties.

Table 26-2 Access Tester Supported System Properties

Property	Access Tester Mode	Description and Command Syntax
log.traceconnfile	Tester Console and Command Line modes	Logs connection details to the specified file name. -Dlog.traceconnfile="<file-name>"
display.fontname	Tester Console mode	Starts the Access Tester with the specified font. This could be useful in compensating for differences in display resolution. - Ddisplay.fontname ="<font-name>"
display.fontsize	Tester Console mode	Starts the Access Tester with the specified font size. This could be useful in compensating for differences in display resolution. - Ddisplay.fontsize ="<font-size>"
display.usesystem	Tester Console mode	Starts the Access Tester with the default font name and size (Dialog font, size 10). - Ddisplay.usesystem
script.scriptfile	Command Line mode	Runs the script <file-name> in command line mode. -Dscript.scriptfile="<file-name>"
control.configfile	Command Line mode	Overwrites script's "configfile" attribute containing the absolute path to the configuration XML file with the connection information. The Access Tester uses the configuration file to establish a connection to the Policy Server indicated by Connection element. -Dcontrol.config="<file-name>"
control.testname	Command Line mode	Overwrites script's "testname" attribute of the Control element containing a string representing a name of the test series to be used in naming output script, stats, and log files. Output log files begin with <testname>_<testnumber>. -Dcontrol.testname="<String>"

Table 26-2 (Cont.) Access Tester Supported System Properties

Property	Access Tester Mode	Description and Command Syntax
control.testnumber	Command Line mode	Specifies the control number to be used in naming output script, stats, and log files. Output log files begin with <testname>_<testnumber>. -Dcontrol.testnumber="<String>". Although the auto generated string is a 7 digit number based on current local time (2 character minutes + 2 character seconds + 3 character hundredths), any string can be used to denote the control number as long as it can be used in a filename.
control.ignorecontent	Command Line mode	Overwrites script's "ignorecontent" attribute of the Control element indicating the Access Tester should ignore differences in Content between the original test case and current results. -Dcontrol.testname="true false"
control.displayiterationstats	Command Line mode	Controls whether or not to display intermediate statistics after each iteration of the test run. -Dcontrol.displayiterationstats="true false"
control.loopback	Command Line mode	Runs the Access Tester in loopback mode to test the Access Tester for internal regressions against a known good script. Used for unit testing the Access Tester. -Dcontrol.loopback="true"

26.3.3 Starting the Tester Without System Properties For Use in Tester Console Mode

To manually drive (and capture) requests and view real-time response through the graphical user interface, start the tester in Tester Console mode. This procedure omits all system properties, even though several can be used with Tester Console mode.

The jar file defines the class to be started by default; no class name need be specified. Ensure that the nap-api.jar is present in the same directory as oamtest.jar.

See Also:

- ["System Properties Supported by the Access Tester "](#)
 - ["Starting the Access Tester with System Properties For Use in Command Line Mode"](#)
-
-

To start the Access Tester in console mode without system properties

1. From the directory containing the Access Tester jar files, enter the following command:

```
java -jar oamtest.jar
```

2. Use the `-help` option to list all the options available for the `oamtest` command-line tool.

```
java -jar oamtest.jar -help
```

3. Proceed to one of the following topics for more information:
 - [Access Tester Console, Navigation, and Controls](#)
 - [Testing Connectivity and Policies from the Access Tester Console](#)
 - [Creating and Managing Test Cases and Scripts](#)

26.3.4 Starting the Access Tester with System Properties For Use in Command Line Mode

This section is divided into the following topics:

- [About the Access Tester Command Line Mode](#)
- [Starting the Tester Without System Properties For Use in Tester Console Mode](#)

26.3.4.1 About the Access Tester Command Line Mode

To run a test script, or to customize Access Tester operations, you must start the tester in command line mode and include system properties using the Java `-D` option.

See Also:

["System Properties Supported by the Access Tester "](#)

When running in command line mode, the Access Tester returns completion codes that can be used by shell scripts to manage test runs. When you run the Access Tester in Console mode, you do not need to act upon codes that might be returned by the Access Tester.

Shell scripts that wrap the Access Tester to execute specific test cases must be able to recognize and act upon exit codes communicated by the Access Tester. In command line mode, the Access Tester exits using `System.Exit(N)`, where `N` can be one of the following codes:

- 0 indicates successful completion of all test cases with no mismatches. This also includes a situation where no test cases are defined in the input script.
- 3 indicates successful completion of all test cases with at least one mismatch.
- 1 indicates that an error prevented the Access Tester from running or completing test cases. This includes conditions such as No input script specified, Unable to read the input script, Unable to establish server connection, Unable to generate the target script.

These exit codes can be picked up by shell scripts (`$?` In Bourne shell) designed to drive the Access Tester to execute specific test cases.

26.3.4.2 Starting the Access Tester with System Properties

Use the following procedure to start the Access Tester in command line mode and specify any number of configuration options using the Java-D mechanism.

See Also:

["System Properties Supported by the Access Tester "](#)

To start the Access Tester with system properties or for use in command line mode

1. From the directory containing the Access Tester jar files, enter the command with the appropriate system properties for your environment. For example:

```
java -Dscript.scriptfile="\tests\script.xml" -Dcontrol.ignorecontent="true"  
-jar oamtest.jar
```

2. After startup, proceed to one of the following topics for more information:
 - [Testing Connectivity and Policies from the Access Tester Console](#)
 - [Creating and Managing Test Cases and Scripts](#)

26.4 Access Tester Console, Navigation, and Controls

Using Access Tester console you can establish a connection to the OAM server, validate protected status of a resource, and confirm authentication and authorization.

[Figure 26-3](#) shows the fixed-size Access Tester Console. This is the window through which users can interact with the application if the Access Tester is started in Console mode. The window can not be resized. Details follow the screen.

Figure 26-3 Access Tester Console

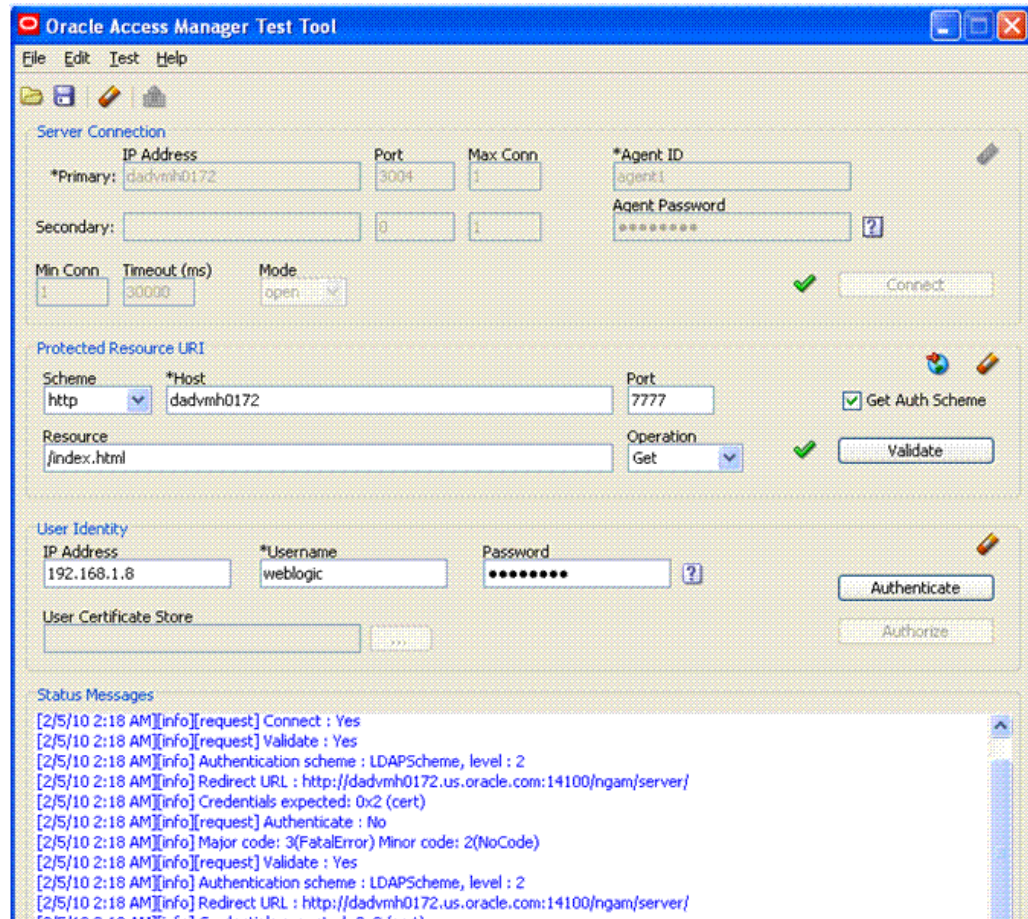

At the top of the main window are the menu names within a menu bar. Under the menu bar is the tool bar. All of the commands represented by buttons in the tool bar are also available as menu commands. The Access Tester Console is divided into four panels, described in [Table 26-3](#).

Table 26-3 Access Tester Console Panels

Panel Name	Description
Server Connection	Provides fields for the information required to establish a connection to the OAM Server (a single primary server and a single secondary server), and the Connect button: See also: " Establishing a Connection Between the Access Tester and the OAM Server ".
Protected Resource URI	Provides information about a resource whose protected status needs to be validated. The Validate button is used to submit the Validate Resource server request. See also: " Validating Resource Protection from the Access Tester Console ".

Table 26-3 (Cont.) Access Tester Console Panels

Panel Name	Description
User Identity	Provides information about a user whose credentials need to be authenticated. The Authenticate button is used to submit the Authenticate User server request. See also: " Testing User Authentication from the Access Tester Console ".
Status Messages	Provides a scrollable status message area containing messages displayed by the application in response to user gestures. The Authorize button is used to submit the Authorize User server request. See also: " Observing Request Latency ".

Text fields support right-clicking to display the Edit menu and drag-and-drop operations using the mouse and cursor.

There are four primary buttons through which you submit test requests to the OAM Server. Each button acts as a trigger to initiate the named action described in [Table 26-4](#).

Table 26-4 Command Buttons in Access Tester Panels

Panel Button	Description
Connect	Submits connection information and initiates connecting.
Validate	Submits information provided in the Protected Resource URI panel and initiates validation of protection.
Authenticate	Submits information provided in the User Identity panel and initiates authentication confirmation.
Authorize	Submits information provided in the User Identity panel and initiates authorization confirmation.

See Also:

["Access Tester Menus and Command Buttons"](#)

26.4.1 Access Tester Menus and Command Buttons

Additional Access Tester Console control buttons and command buttons provide a tip when the cursor is on the button.

[Table 26-5](#) identifies additional Access Tester Console buttons and their use.

Table 26-5 Additional Access Tester Buttons

Command Buttons	Description
Open Folder	Loads connection configuration details that were saved to an XML file (config.xml, by default). You can refresh the information in the Console by clicking this button.
Disk	Saves connection configuration details to a file (default name, config.xml). You can add the name of this document to the input script to provide proper connection information to the Access Tester running in command line mode. The Save command button at the bottom of the Console saves the content of the Status Message panel to a log file.
Eraser	Clears fields on a panel containing the icon. Tool bar action clears all fields except connection fields if the connection has already been established.
Blue Up Arrows	Captures the last named request to the capture queue with the corresponding response received from the OAM Server. Together, the request and response create a test case. The capture queue status at the bottom of the Console is updated to reflect the number of test cases in the queue. You can save the contents of the capture queue to create a test script containing multiple test cases using the Generate Script command on the Test menu or a command button.
Paper Scroll	Generates a test script that includes every test case currently in the capture queue, and asks if the queue should be cleared. Do not clear the queue until all your test cases have been captured and saved to a test script.
Paper Scroll with right facing arrow	Runs a test script against the current OAM Server. The Status message window is populated with the execution status as the script progresses through each test case.
Globe with right facing red arrow	Imports a copied URI from the clipboard after parsing it to populate fields in the URI panel.
Question Mark	Displays a dialog showing the password in clear text

The Access Tester provides the menus described in [Table 26-6](#). All menu items have mnemonics that are exposed by holding down the ALT key (on Windows systems). There are also command accelerators (keyboard activation) available using the CTRL-<KEY> combination defined for each menu command.

Table 26-6 Access Tester Menus

Menu Title	Menu Commands
File	<ul style="list-style-type: none"> • Open Configuration • Save Configuration • Exit <p>Note: To minimize the amount of data entry the Save Configuration and Open Configuration menu (and tool bar command buttons) allow for specific Connection, URI, and Identity information to be saved to (and read from) a file. Thus, it becomes fairly simple to manage multiple configurations. Also, the configuration file can be used as input to the Access Tester when you run it in command line mode and execute a test script.</p>
Edit	<p>Provides standard editing commands, which act on fields:</p> <ul style="list-style-type: none"> • Cut • Copy • Paste • Clear all fields • Import URI fields from a saved URL
Test	<ul style="list-style-type: none"> • Capture last "... request (for example, Capture last "authorize" request) • Save test script • Run test script <p>Note: You can use functions here to capture the last request and response to create a test case that you can save to a test script to be run at a later time.</p>
Help	The command About, which displays usage information.

26.5 Testing Connectivity and Policies from the Access Tester Console

You can perform quick spot checks using the Access Tester in Console mode with OAM Servers.

Spot checks or troubleshooting connections between the Agent and OAM Server can help you assess whether the Agent can communicate with the OAM Server, which is especially helpful after an upgrade or product migration. Spot checks or troubleshooting resource protection that can be exercised by Agents and OAM Servers can help you develop end-to-end tests of policy configuration during the application lifecycle.

The following overview identifies the tasks and sequence to be performed and where to locate additional information about each task.

Note:

You can capture each request and response pair to create a test case, and save the test cases to a script file that can be run later. For details, see "[Creating and Managing Test Cases and Scripts](#)".

Task overview: Performing spot checks from the Access Tester Console

1. Start the Access Tester, as described in "[Installing and Starting the Access Tester](#)".

2. Add relevant details to the Server Connection panel and click Connect, as described in "[Establishing a Connection Between the Access Tester and the OAM Server](#)".
3. Enter or import details into the Protected Resource URI pane and click Validate, as described in "[Validating Resource Protection from the Access Tester Console](#)".
4. Add relevant details to the User Identity panel and click Authenticate, as described in "[Testing User Authentication from the Access Tester Console](#)".
5. After successful authentication, click Authorize in the User Identity panel, as described in "[Testing User Authorization from the Access Tester Console](#)".
6. Check the latency of requests, as described in "[Observing Request Latency](#)".

26.5.1 Establishing a Connection Between the Access Tester and the OAM Server

Before you can send a request to the OAM Server you must establish a connection between the Access Tester and the server.

This section describes how to establish that connectivity.

- [Server Connection Panel in the Access Tester](#)
- [Connecting the Access Tester with the OAM Server](#)

26.5.1.1 Server Connection Panel in the Access Tester

You enter required information for the OAM Server and the Agent you are emulating in the Access Tester Connection panel and then click the Connect button. The Tester initiates the connection, and displays the status in the Status Messages panel. Once the connection is established, it is used for all further operations.

Caution:

Once the connection is established, it cannot be changed until you restart the Access Tester Console.

[Figure 26-4](#) illustrates the Server Connection panel and controls. This panel contains information needed to establish a connection to the OAM Server's Proxy port.

Figure 26-4 *Server Connection Panel in the Access Tester*

[Table 26-7](#) describes the information needed to establish the connection. The source of your values is the Oracle Access Management Console, System Configuration tab.

Table 26-7 Connection Panel Information

Fields	Description
IP Address	<p>The IP Address of the Primary and Secondary OAM Proxy listens on for this set of tests.</p> <p>Note: Oracle recommends that you enter values for only the Primary OAM Proxy. The Secondary OAM Proxy is needed only if you want to test failover between the primary and secondary OAM Server. However, a more practical use of the Secondary Server is reserved for later use, when the OAP API supports load balancing between Primary and Secondary OAM Server.</p>
Port	<p>Enter the port number of the Primary and Secondary OAM Server.</p>
Max Conn	<p>The maximum number of physical connection (TCP) sockets the Access Tester will use. Access Tester emulates a single threaded Agent.</p> <p>Note: Oracle recommends that you accept the default value, 1.</p>
Min Conn	<p>The minimum number of physical connection (TCP) sockets the Access Tester will use. The Access Tester emulates a single threaded Agent.</p> <p>Note: Oracle recommends that you accept the default value, 1.</p>
Timeout	<p>The number of milliseconds the Access Tester should wait for the connection to be established or to receive a response from the OAM Server.</p> <p>Note: Oracle recommends that you accept the default value.</p>
Mode	<p>The level of communication security that is designated for the Agent to be emulated.</p> <ul style="list-style-type: none"> Open--No special configuration needed for this mode. Simple--Presents a field for the global pass phrase set for the OAM Server. See Also: "Retrieving the Global Passphrase for Simple Mode". Cert--Presents a Configure Certs ... button that opens a dialog asking for the following: <ul style="list-style-type: none"> Trust Store (Root Store Alias): A file containing the JKS key store with the root CA certificate. Key Store: A file containing the JKS key store with the agent's private key and certificate. Currently, the agent certificate is used for encrypting the connection and not the agent identification. Key Store Password: The password used to encrypt the Key Store with the agent certificates. <p>See Also: "About Access Tester Security and Processing", and "Generating Client Keystores for OAM Tester in Cert Mode".</p>
Agent ID	<p>Enter the identity of the OAM Agent the Tester is simulating.</p>
Agent Password	<p>Enter the password for the OAM Agent the Tester is simulating, if there is one configured.</p>

Table 26-7 (Cont.) Connection Panel Information

Fields	Description
Question Mark	Click ? beside the Agent Password field for help.
Green Check Mark	The green check mark beside the Connect button indicates a "Yes" response; the connection is made. The Status Messages panel also indicates a "Yes" response for the connection.
X in red circle	The red circle beside the Connect button indicates a "No" response; no connection exists. The Status Messages panel also indicates a "No" response for the connection.

After entering information and establishing a connection, you can save details to a configuration file that can be re-used later.

See Also:

["Establishing a Connection Between the Access Tester and the OAM Server"](#)

26.5.1.2 Connecting the Access Tester with the OAM Server

You can submit your connection details for the OAM Server.

Note:

Cert mode requires the presence of keystores generated as described in [Securing Communication](#)

Prerequisites

[Installing and Starting the Access Tester](#)

See Also:

["Server Connection Panel in the Access Tester"](#)

To test connectivity between the Access Tester and the OAM Server

1. Start the Access Tester, as described in ["Installing and Starting the Access Tester"](#).
2. In the Server Connection Panel ([Table 26-7](#)), enter:
 - Primary and secondary OAM Proxy details
 - Timeout period
 - Communication encryption mode
 - Agent details
3. Click the Connect button.

4. Beside the Connect button, look for the green check mark indicating the connection is established.
5. In the Status Messages panel, verify a Yes response.

Not Successful: If there is a problem connecting to the OAM Server, ensure that you entered all connection information correctly (IP address and port, Agent name and password, connection mode and related certificates and passwords, as needed).

If the connection still cannot be made, start the Access Tester Console using the Trace Connection command mode and look for additional details in the connection log. Also, ask the Administrator of the OAM Server to review the policy server log.

26.5.2 Validating Resource Protection from the Access Tester Console

Before a user can access a resource, the Agent must first validate that the resource is protected.

Using the Access Tester, you can act as the Agent to have the OAM Server validate whether or not the given URI is protected and communicate the response to the Access Tester, as described here.

- [Protected Resource URI Panel in the Access Tester](#)
- [Validating Resource Protection](#)

26.5.2.1 Protected Resource URI Panel in the Access Tester

You must enter required information for the resource you want to validate in the Access Tester Protected Resource URI panel, and then click the Validate button.

To minimize data entry, you can import long URIs that you have copied from a browser and then click the Import URI command button. The Tester parses the URI saved to the clipboard and populates the URI fields in the Access Tester.

[Figure 26-5](#) illustrates the panel where you enter the URI details to validate that the resource is protected. When combined, the URI fields follow RFC notation. For example: `http://oam_server1:7777/index.html`.

Figure 26-5 Protected Resource URI Panel in the Access Tester

The screenshot shows a window titled "Protected Resource URI". It contains the following fields and controls:

- Scheme:** A dropdown menu with "http" selected.
- *Host:** A text input field containing "dadvmh0172".
- Port:** A text input field containing "7777".
- Resource:** A text input field containing "/index.html".
- Operation:** A dropdown menu with "Get" selected.
- Get Auth Scheme:** A checkbox that is checked.
- Validate:** A button with a green checkmark icon to its left.

[Table 26-8](#) describes the information needed to perform this validation.

Table 26-8 Protected Resource URI Panel Fields and Controls

Field or Control	Description
Scheme	Enter http or https, depending on the communication security specified for the resource. Note: The Access Tester supports only http or https resources. You cannot use the Access Tester to test policies that protect custom non-http resources.

Table 26-8 (Cont.) Protected Resource URI Panel Fields and Controls

Field or Control	Description
Host	Enter a valid host name for the resource. Note: Your <host:port> combination specified in the Access Tester must match one of the Host Identifiers defined in the Oracle Access Management Console. If the host identifier is not recognized, OAM cannot validate resource protection.
Port	Enter a valid port for the URI. Note: The <host:port> combination specified in the Access Tester must match one of the Host Identifiers as defined in the OAM Server. If the host identifier is not recognized, OAM cannot validate resource protection.
Resource	Enter the Resource component of the URI (/index.htm in the example). This resource should match a resource defined for an authentication and authorization policy in the Oracle Access Management Console. Note: If protected, the resource identifier that you provide here must match the one specified in an authorization policy in the Oracle Access Management Console.
Globe with red arrow	Click this button to parse and import a URI that is saved on a clipboard.
Operation	Select the operational component of the URI from the list provided in the Access Tester. The OAM Server does not distinguish between different actions, however. Therefore, leaving this set to Get should suffice.
Get Auth Scheme	Check this box to request the OAM Server to return details about the Authentication Scheme that is used to secure the protected resource. If the URI is protected, this information is displayed in the Status Messages panel.
Validate	Click the Validate button to submit the request to the OAM Server. When the response is received, the Access Tester displays it in the Status Messages panel.
Green Check Mark	A green check mark appearing beside the Validate button indicates a "Yes" response; the resource is protected. The Status Messages panel provides the redirect URL for the resource and that credentials are expected. Note: If you checked the Get Auth Scheme box, the name and level of the Authentication Scheme that protects this resource are also provided in the Status Messages panel.
X in red circle	A red circle appearing beside the Validate button indicates that the resource is not protected. A No response will also appear in the Status Messages.

You can capture each request and response pair to create a test case, and save multiple test cases to a script file that can be run later.

See Also:

- ["Validating Resource Protection from the Access Tester Console"](#)
 - ["Creating and Managing Test Cases and Scripts"](#)
-
-

26.5.2.2 Validating Resource Protection

You can submit your resource information to the OAM Server and verify responses in the Status Messages panel.

Prerequisites

[Establishing a Connection Between the Access Tester and the OAM Server](#)

See Also:

["Protected Resource URI Panel in the Access Tester"](#)

To confirm that a resource is protected

1. In the Access Tester Protected Resource URI panel, enter or import your own resource information ([Table 26-8](#)).
2. Click the Validate button to submit the request.
3. Review Access Tester output, including the relevant data about the resource such as how the resource is protected, level of protection, and so on.
4. Beside the Validate button, look for the green check mark indicating the resource is protected.
5. In the Status Messages panel, verify the redirect URL, authentication scheme, and that credentials are expected.
6. Capture the request and response to create a test case for use later, as described in ["Creating and Managing Test Cases and Scripts"](#).
7. Retain the URI to minimize data entry and server processing using one of the following methods.
8. Proceed to ["Testing User Authentication from the Access Tester Console"](#)

26.5.3 Testing User Authentication from the Access Tester Console

This topic provides the following information:

- [User Identity Panel in the Access Tester](#)
- [Testing User Credential Authentication](#)

26.5.3.1 User Identity Panel in the Access Tester

Before a user can access a resource, the Agent must validate the user's identity based on the defined authentication policy on the OAM Server. Using the Access Tester, you can act as the Agent to have the OAM Server authenticate a specific userID for the

protected resource. All relevant authentication responses are considered during this policy evaluation.

Figure 26-6 illustrates the Access Tester panel where you enter the information needed to test authentication.

Figure 26-6 Access Tester User Identity Panel

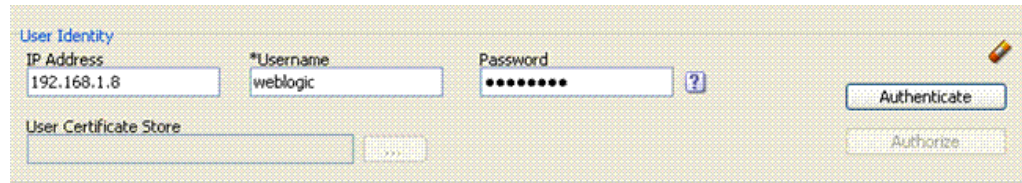

Table 26-9 describes the information you must provide.

Table 26-9 Access Tester User Identity Panel Fields and Controls

Field or Control	Description
IP Address	<p>Enter the IP Address of the user whose credentials are being validated. All Agents communicating with the OAM Server send the IP address of the end user.</p> <p>Default: The IP address that is filled in belongs to the computer from which the Access Tester is run.</p> <p>To test a policy that requires a real user IP address, replace the default IP address with the real IP address.</p>
User Name	<p>Enter the userID of the individual whose credentials are being validated.</p> <p>Note: The Access Tester enables or disables the username and password fields if the resource is protected by an authentication scheme that requires those credentials. Similarly the Access Tester enables or disables the certificate field if the resource is protected by an authentication scheme that requires a user's X509 certificate.</p>
Password	<p>Enter the password of the individual whose credentials are being validated.</p>
?	<p>Click this button to display the password in clear text within a popup window.</p>
User Certificate Store	<p>The PEM format file containing the X.509 certificate of the user whose credentials should be authenticated.</p> <p>If the URI is protected by the X509 Authentication Scheme then the Tester will use the PEM-formatted X509 certificate as a credential instead of or in addition to the username/password. The X509 cert may also be used for authorization if security policies are so configured on the OAM Server.</p> <p>Note: For certificate-based authentication to work, the OAM Server must be properly configured with root CA certificates and SSL keystore certificates. See Securing Communication for details about securing communication between OAM Servers and Webgates.</p>
...	<p>Click this button to browse the file system for the user certificate store path.</p>

Table 26-9 (Cont.) Access Tester User Identity Panel Fields and Controls

Field or Control	Description
Authenticate	<p>Click the Authenticate button to submit the request to the OAM Server and look for a response in the Status Messages panel.</p> <p>Note: The type of credentials supplied (username/password or X.509 certificate) must match the requirements of the authentication scheme that protects the URI.</p> <p>Note: For certificate-based authentication, the OAM Server deployment must be properly configured with certificates as described in Securing Communication.</p>
Authorize	<p>After the user's credentials are validated, you can click the Authorize button to submit the request for the resource to the OAM Server. Check the Status Messages panel for a response.</p> <p>This request submits information collected in the URI and Identity panels to the OAM Server to decide if the user defined on the Identity panel can access the resource defined on the URI panel. The server returns Yes (user can access the resource) or No (user can not access the resource). The OAM Server might return additional information such as actions (responses) that the real Agent would normally handle.</p>
Green Check Mark	<p>A green check mark appearing beside the Authenticate button indicates authentication success; The Status Messages panel also indicates "yes" authentication was successful, and provides the user DN and session id.</p> <p>A green check mark appearing beside the Authorize button indicates authorization success; The Status Messages panel also indicates "yes" authorization was successful, and provides Application Domain details.</p>
X in red circle	<p>A red circle appearing beside the Authenticate button indicates authentication failure; The Status Messages panel also indicates "no" authentication was not successful.</p> <p>A red circle appearing beside the Authorize button indicates authorization failure; The Status Messages panel also indicates "no" authorization was not successful.</p>

You can capture each request and response pair to create a test case, and save multiple test cases to a script file that can be run later.

See Also:

- ["Testing User Authentication from the Access Tester Console"](#)
 - ["Creating and Managing Test Cases and Scripts"](#)
-
-

26.5.3.2 Testing User Credential Authentication

You can submit the end user credentials to the OAM Server and verify authentication. All relevant authentication responses are considered during this policy evaluation.

Prerequisites

[Validating Resource Protection from the Access Tester Console](#) with URI information retained in the Console.

See Also:

["User Identity Panel in the Access Tester"](#)

To test user credential authentication

1. In the Access Tester User Identity panel, enter information for the user to be authenticated ([Table 26-9](#)).
2. Click the Authenticate button to submit the request.
3. Beside the Authenticate button, look for the green check mark indicating the user is authenticated.

Not Successful: Confirm that you entered the correct userID and password and try again. Also, check the Oracle Access Management Console for an active user session that you might need to end, as described in [Maintaining Access Manager Sessions](#).

4. Capture the request and response to create a test case for use later, as described in ["Creating and Managing Test Cases and Scripts"](#).
5. Retain the URI and user identity information and proceed to ["Testing User Authorization from the Access Tester Console"](#).

26.5.4 Testing User Authorization from the Access Tester Console

Before a user can access a resource, the Agent must validate the user's permissions based on defined policies on the OAM Server. Using the Access Tester, you can act as the Agent to have the OAM Server validate whether or not the authenticated user identity can be authorized to access the resource. You verify the authenticated end user's authorization for the resource. All relevant authorization conditions and responses are considered during this policy evaluation.

Prerequisites

[Testing User Authentication from the Access Tester Console](#) with all information retained in the Console.

See Also:

["User Identity Panel in the Access Tester"](#)

Note:

Once the protected resource URI is confirmed and the user's identity is authenticated from the Access Tester, no further information is needed. You simply click the Authorize button to submit the request. However, if the resource is changed to another you must start the sequence anew and validate, then authenticate, and then authorize.

To test user authorization

1. In the Access Tester User Identity panel, confirm the user is authenticated ([Table 26-9](#)).
2. In the Access Tester User Identity panel, click the Authorization button.
3. Beside the Authorization button, look for the green check mark indicating the user is authorized.

Not Successful: Confirm the authorization policy using the Oracle Access Management Console.
4. In the Status Messages panel (or execution log file), verify details about the test run.
5. Capture the request and response to create a test case for use later, as described in "[Creating and Managing Test Cases and Scripts](#)".
6. Proceed to:
 - [Observing Request Latency](#)
 - [Creating and Managing Test Cases and Scripts](#)
 - [Evaluating Scripts, Log File, and Statistics](#)

26.5.5 Observing Request Latency

To understand OAM Server performance you must know how well the OAM Server handles requests passed by the Agent. While there are many ways to expose a server's metrics, it is sometimes useful to expose server performance from the standpoint of the Agent.

Using the Access Tester, you can do just that as described here.

Prerequisites

["Installing and Starting the Access Tester"](#)

Task overview: Observing request latency includes

1. ["Validating Resource Protection "](#)
2. ["Testing User Authentication from the Access Tester Console"](#)
3. ["Testing User Authorization from the Access Tester Console"](#)
4. Check latency information in the execution log file as shown here, as well as in other files generated during a test run. For example:

```
...
[2/3/12 11:03 PM][info] Summary statistics
[2/3/12 11:03 PM][info] Matched 4 of 4, avg latency 232ms vs 238ms
[2/3/12 11:03 PM][info] Validate: matched 2 of 2, avg latency 570ms vs 578ms
[2/3/12 11:03 PM][info] Authenticate: matched 1 of 1, avg latency 187ms vs 187ms
[2/3/12 11:03 PM][info] Authorize: matched 1 of 1, avg latency 172ms vs 188ms
...
```

5. Proceed to:
 - [Creating and Managing Test Cases and Scripts](#)

- [Evaluating Scripts, Log File, and Statistics](#)

26.6 Creating and Managing Test Cases and Scripts

Test management refers to the creation of repeatable tests that can be executed at any time by an individual Administrator or system. Quick spot checks are very useful and effective in troubleshooting current issues. However, a more predictable and repeatable approach to validating server and policy configuration is often necessary.

This approach can include testing OAM Server configuration for regressions after a product revision, or during a policy development and QA cycle.

To be useful such tests must allow for multiple use cases to be executed as group. Once the test scripts have been designed and validated as correct, replaying the tests against the OAM Server helps identify regressions in a policy configuration.

This section provides the information you need to perform test management in the following topics:

- [About Test Cases and Test Scripts](#)
- [Capturing Test Cases](#)
- [Generating an Input Test Script](#)
- [Personalizing an Input Test Script](#)
- [Executing a Test Script](#)

26.6.1 About Test Cases and Test Scripts

A test case is created from the request sent to, and response data received from, the OAM Server using the Access Tester. Among other data elements, a test case includes request latency and other identifying information that enables analysis and comparison of old and new test cases. Test scripts can be configured, run, and generated from the Access Tester Console.

Once captured, the test case can be replayed without new input, and then new results can be compared with old results. If the old results are marked as "known good" then deviations from those results constitute failed test cases.

The test case workflow is illustrated by [Figure 26-7](#).

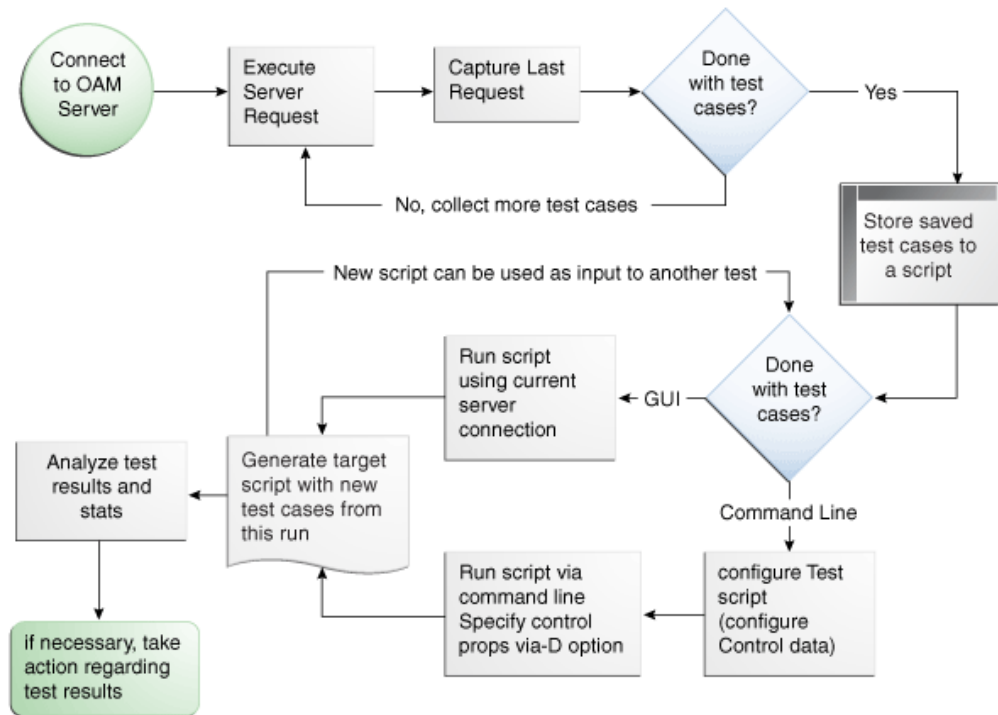
Figure 26-7 Test Case Workflow**Task overview: Creating and managing a test case**

From the Access Tester Console, you can connect to the OAM Server and manually conduct individual tests. You can save the request to the capture queue after a request is sent and the response is received from the OAM Server. You can continue capturing additional test cases before generating a test script and clearing the capture queue. If you exit the Access Tester before saving the capture queue, you are asked if the test cases should be saved to a script before exiting. Oracle recommends that you do not clear the queue until all your test cases have been captured.

Once you have the test script, you can run it from either the Access Tester Console or from the command line.

26.6.2 Capturing Test Cases

You can save each test case to a capture queue after sending the request from the Access Tester to the OAM Server and receiving the response. You can capture as many individual test cases as you need before generating a test script that will automate running the group of test cases.

For instance, the following outlines three test cases that must be captured individually:

- A validation request and response
- An authentication request and response
- An authorization request and response

Table 26-10 describes the location of the capture options.

Table 26-10 Access Tester Capture Request Options

Location	Description
Test menu Capture last "..." request	Select this command from the Test menu to add the last request issued and results received to the capture queue (for inclusion in a test script later).
Blue up arrow	Select this command button from the tool bar to add the last request issued and results received to the capture queue (for inclusion in a test script later).

If you exit the Access Tester before saving the capture queue, you are asked if the test cases should be saved to a script before exiting. Do not clear the Access Tester capture queue until all your test cases have been captured.

To capture one or more test cases

1. Initiate a request from the Access Tester Console, as described in "[Testing Connectivity and Policies from the Access Tester Console](#)".
2. After receiving the response, click the Capture last "..." request command button in the tool bar (or choose it from the Test menu).
3. Confirm the capture in the Status Messages panel and note the Capture Queue test case count at the bottom of the Console.
4. Repeat steps 1, 2, and 3 to capture in the queue each test case that you need for your test script.
5. Proceed to "[Generating an Input Test Script](#)".

26.6.3 Generating an Input Test Script

A test script is a collection of individual test cases that were captured using the Access Tester Console. When individual test cases are grouped together, it becomes possible to automate test coverage to validate policy configuration for a specific application or site.

You can create a test script to be used as input to the Access Tester and drive automated processing of multiple test cases. The Generate Script option enables you to create an XML file test script and clear the capture queue. If you exit the Access Tester before saving the capture queue, you are asked if the test cases should be saved to a script before exiting. The following sections provide more details:

- [About Input Test Script](#)
- [Generating an Input Test Script](#)

Note:

Do not clear the capture queue until you have captured all the test cases you want to include in the script.

26.6.3.1 About Input Test Script

You can create a test script to be used as input to the Access Tester and drive automated processing of multiple test cases.

Such a script must follow these rules:

- Allows possible replay by a person or system
- Allows possible replay against different policy servers w/o changing the script, to enable sharing of test scripts to drive different Policy Servers
- Allows comparison of test execution results against "Known Good" results

Following are the locations of the Generate Script command.

Table 26-11 Generate Script Command

Location of the Command	Description
Test menu Generate Script	Select Generate Script from the Test menu to initiate creation of the script containing your captured test cases.
Paper Script Scroll	Select the Generate Script command button from the tool bar to initiate creation of the script containing your captured test cases. After you specify or select a name for your script, you are asked if the capture queue should be cleared. Do not clear the capture queue until all your test cases are saved to a script.

26.6.3.2 Generating an Input Test Script

You can capture test cases that you want in your test script and record it.

Prerequisites

[Capturing Test Cases](#)

To record a test script containing captured test cases

1. Perform and capture each request that you want in the script, as described in "[Capturing Test Cases](#)".
2. Click the Generate Script command button in the tool bar (or choose it from the Test menu to include all captured test cases).
3. In the new dialog box, select or enter the name of your new XML script file and then click Save.
4. Click Yes to overwrite an existing file (or No to dismiss the window and give the file a new name).
5. In the Save Warning dialog box, click No to retain the capture queue and continue adding test cases to your script (or click Yes to clear the queue of all test cases).
6. Confirm the location of the test script before you exit the Access Tester.
7. Personalize the test script to include details such as who, when, and why the script was developed, as described next.

26.6.4 Personalizing an Input Test Script

This section describes how to personalize and customize a test script.

- [Test Script Control Parameters](#)
- [Customizing a Test Script](#)

26.6.4.1 Test Script Control Parameters

The control block of a test script is used to tag the script and specify information to be used during the execution of a test. You might want to include details about who created the script and when and why the script was created. You might also want to customize the script using one or more control parameters.

The Access Tester provides command line "control" parameters to change processing of the script without changing the script. (test name, test number, and so on). This enables you to configure test runs without having to change "known good" input test scripts. [Table 26-12](#) describes the control elements and how to customize these.

Table 26-12 Test Script Control Parameters

Control Parameter	Description
<code>ignorecontent=true</code>	<p> Ignores differences in the Content section of the use case when comparing the original OAM Server response to the current response. The default is to compare the Content sections. This parameter can be overwritten by a command line property when running in the command line mode.</p> <p>Default: false (Compare Content sections).</p> <p>Values: true or false</p> <p>In command line mode, use <code>ignorecontent=true</code> to over ride the specified value in the Control section of the input script.</p>
<code>testname="oamtest"</code>	<p>Specifies a prefix to add to file names in the "results bundle" as described in the previous section.</p> <p>In command line mode, use <code>Testname=name</code> to over ride the specified value in the Control section.</p>
<code>configfile="config.xml"</code>	<p>Specifies the absolute path to a configuration XML file that was previously created by the Access Tester.</p> <p>In command line mode, this file is used by the Access Tester to locate connection details to establish a server connection.</p>
<code>numthreads="1"</code>	<p>Indicates the number of threads (virtual clients) that will be started by the Access Tester to run multiple copies of the test script. Each thread opens its own pool of connections to the policy server. This feature is designed for stress testing the Policy Server, and is available only in command line mode.</p> <p>Default: 1</p> <p>Note that when running a test script in GUI mode, the number of threads is ignored and only one thread is started to perform a single iteration of the test script.</p>

Table 26-12 (Cont.) Test Script Control Parameters

Control Parameter	Description
numiterations="1"	Indicates the number of iterations that will be performed by the Access Tester. This feature is designed for stress testing and longevity testing the Policy Server and is available only in command line mode. Default: 1

26.6.4.2 Customizing a Test Script

You can personalize a test script generated by the Access Tester.

Prerequisites

[Generating an Input Test Script](#)

To customize a test script

1. Locate and open the test script that was generated by the Access Tester.
2. Add any details that you need to customize or personalize the script.
3. Save the file and proceed to "[Executing a Test Script](#)".

26.6.5 Executing a Test Script

Once a test script has been created against a "Known Good" policy configuration and marked as "Known Good", it is important to drive the Access Tester using the script rather than specifying each test manually using the Console.

This section provides the following topics:

- [About Test Script Execution](#)
- [Running a Test Script](#)

26.6.5.1 About Test Script Execution

You can interactively execute tests scripts from within the Access Tester Console, or use automated test runs performed by command scripts.

Automated test runs can be scheduled by the operating system or a harness such as Apache JMeter, and executed without manual intervention. Other than lack of human input in command line mode, the two execution modes are identical.

Note:

A script such as .bat (Windows) or .sh (Unix) executes a test script in command line mode. Once a test script is created, it can be executed using either the Run Script menu command or the Access Tester command line.

[Table 26-13](#) describes the commands to execute a test script.

Table 26-13 Run Test Script Commands

Location	Description
Test menu Run Script	Select the Run Script command from the Test menu to begin running a saved test script against the current policy server. The Status message panel is populated with the execution status as the script progresses.
Paper Script Scroll with green arrow	Select the Run Script command button from the tool bar to begin running a saved test script against the current policy server. The Status message panel is populated with the execution status as the script progresses.
Command line mode	A script such as .bat (Windows) or .sh (Unix) executes a test script in command line mode. Once a test script is created, it can be executed using either the Run Script menu command or the Access Tester command line.

The following overview describes how the Access Tester operates when running a test. Other than lack of human input in command line mode, the two execution modes are identical.

Process overview: Access Tester behavior when running a test script

1. The Access Tester loads the input xml file.

In command line mode, the Access Tester opens the configuration XML file defined within the input test script's Control element.
2. The Access Tester connects to the primary and secondary OAM Proxy using information in the Server Connection panel of the Console.

In command line mode, the Access Tester uses information in the Connection element of the configuration XML file.
3. In command line mode, the Access Tester checks the Control elements in the input script XML file to ensure none have been overwritten on the command line (command line values take precedence).
4. For each original test case defined in the script, the Access Tester:
 - a. Creates a new target test case.
 - b. Sends the original request to the OAM Server and collects the response.
 - c. Makes the following comparisons:

Compares the new response to the original response.

Compares response codes and marks as "mismatched" any new target test case where response codes differ from the original test case. For instance, if the original Validate returned "Yes", and now returns "No", a mismatch is marked.

When response codes are identical, and "the ignorecontent" control parameter is "false", the Access Tester compares Content (the name of the Authentication scheme or post authorization actions that are logged after each request). If Content sections differ, the new target test case is marked "mismatched".
 - d. Collect new elapsed time and store it in the target use case.

- e. Build a new target test case containing the full state of the last server request and the same unique ID (UUID) as the original test case.
 - f. Update the internal statistics table with statistics for the target test case (request type, elapsed time, mismatched, and so on).
5. After completing all the input test cases, the Access Tester:
- a. Displays summary results.
 - b. Obtains and combines the *testname* and *testnumber*, and generates a name for the "results bundle" (three files whose names start with `<testname>_<testnumber>`).

Note:

Shell scripts can automate generating the bundle by providing *testname* and *testnumber* command line parameters.

Obtain *testname* from the command line parameter. If not specified in the command line, use the *testname* element of the input script's Control block.

Obtain *testnumber* from the command line parameter. If not specified, *testnumber* defaults to a 7-character numeric string based on the current local time: 2 character minutes, 2 character seconds, 3 character hundredths.

- c. Generates the "results bundle": three files whose names start with `<testname>_<testnumber>`:

The target XML script contains the new test cases:
`<testname>_<testnumber>_results.xml`.

The statistics XML file contains a summary and detailed statistics of the entire test run, plus those test cases marked as "mismatched":
`<testname>_<testnumber>_stats.xml`

The execution log file contains information from the Status Message panel:
`<testname>_<testnumber>_log.log`.

- d. When running in multi-threaded mode, only the statistics XML file and execution log file will be generated.
- e. In command line mode, the Access Tester exits with the exit code as described in "[About the Access Tester Command Line Mode](#)".

26.6.5.2 Running a Test Script

You can submit your test script for processing through Access Tester Console or opt for command line processing.

Prerequisites

[Generating an Input Test Script](#)

To run a test script

1. Confirm the location of the saved test script before exiting the Access Tester., as described in "[Generating an Input Test Script](#)".
2. Submit the test script for processing using one of the following methods:

- From the Access Tester Console, click the Run Script command button in the tool bar (or select Run Script from the Test menu), then follow the prompts and observe messages in the Status Message panel as the script executes.
- From the command line, specify your test script with the desired system properties, as described in "[Starting the Access Tester with System Properties For Use in Command Line Mode](#)".

```
java -Dscript.scriptfile="\tests\script.xml" -Dcontrol.ignorecontent="true"  
-jar oamtest.jar
```

3. Review the log and output files and perform additional analysis after the Access Tester compares newly generated results with results captured in the input script, as described in "[Evaluating Scripts, Log File, and Statistics](#)".

26.7 Evaluating Scripts, Log File, and Statistics

Access Tester generates statistics file along with the target output script and execution log.

This section provides the following information:

- [About Evaluating Test Results](#)
- [Saved Connection Configuration File](#)
- [Generated Input Test Script](#)
- [Target Output File Containing Test Run Results](#)
- [Statistics Document](#)
- [Execution Log](#)

26.7.1 About Evaluating Test Results

You can evaluate test results using the "results bundle" that gets generated at the end of a test run. This bundle contains three documents: target script, execution log, and execution statistics.

Target script is an XML document containing new test cases. The matching pair of test cases in the original and target scripts shares the test case ID. This ID is represented by a UUID value, which makes it possible to compare individual test cases in the original script with those in the target script. For more information, see "[Generated Input Test Script](#)".

Note:

The target script is not created if the Access Tester is configured to run in multi-threaded mode.

The execution statistics document contains the test metrics, summary and detail statistics, and a list of test cases that did not match. The detailed statistics can be used for further analysis or to keep a historical trail of results. The summary statistics are the same statistics displayed at the end of the test run and can be used to quickly assess the state of a test run.

The list of mismatched test cases as created in the statistics document contains test case IDs that have triggered mismatch and includes the reason for the mismatch, as seen in [Table 26-14](#).

Table 26-14 Mismatched Results Reasons in the Statistics Document

Reason for a MisMatch	Description
Result	The test cases did not match because of the difference in OAM Server response codes (Yes versus No).
Content	The test cases did not match because of the differences in the specific data values that were returned by the OAM Server. The specific values from the last test run that have triggered the mismatch are included.

26.7.2 Saved Connection Configuration File

The Saved Connection Configuration File is the output file that is saved using the Save Configuration command on the File menu; the default file name is config.xml.

This connection configuration file includes details that were specified in the Access Tester Console, Server Connection panel.

Note:

An input test script file is also generated as described in the following topic. The name of the configuration file is used in the input test script to ensure that running the Access Tester in command line mode picks up connection information defined in the connection file.

Connection Configuration File

```
<?xml version="1.0" encoding="UTF-8" standalone="yes"?>
<oamtestconfig xmlns="http://xmlns.example.com/idm/oam/oamtest/schema"
version="1.0">
  <connection timeout="30000" minnconn="1" mode="open">
    <agent password="00030d05101b050c42" name="agent1"/>
    <keystore rootstore="" keystore_password="" keystore=""
global_passphrase=""/>
    <primary>
      <server maxconn="1" port="2100" addr="oam_server1"/>
    </primary>
    <secondary>
      <server maxconn="1" port="0" addr=""/>
    </secondary>
  </connection>
  <uri getauthscheme="true">
    <scheme>http</scheme>
    <host>oam_server1</host>
    <port>7777</port>
    <resource>/index.html</resource>
    <operation>Get</operation>
  </uri>
  <identity>
    <id>admin1</id>
    <password>00030d05101b050c42</password>
    <certstore></certstore>
  </identity>
</oamtestconfig>
```

```

        <ipaddr>111.222.3.4</ipaddr>
    </identity>
</oamtestconfig>

```

26.7.3 Generated Input Test Script

The input test script is generated by using the Access Tester and capturing your own test cases. The "configfile" attribute of the "Control" element is updated after creation to specify the connection configuration file to be used in command-line mode for establishing a connection to the OAM Server.

Generated Input Test Script

```

<?xml version="1.0" encoding="UTF-8" standalone="yes"?>
<oamtestscript xmlns="http://xmlns.example.com/idm/oam/oamtest/schema"
version="1.0">
    <history description="Manually generated using agent 'agent1'"
createdon="2012-02-03T22:28:00.468-05:00" createdby="test_user"/>
    <control numthreads="1" numiterations="1" ignorecontent="false"
testname="samplerun1" configfile="config.xml"/>
    <cases numcases="4">
        <case uuid="465a4fda-d814-4ab7-b81b-f3f1cd72bbc0">
            <request code="Validate">
                <uri getauthscheme="true">
                    <scheme>http</scheme>
                    <host>oam_server1</host>
                    <port>7777</port>
                    <resource>/index.html</resource>
                    <operation>Get</operation>
                </uri>
            </request>
            <response elapsed="984" code="Yes">
                <comment></comment>
                <status>Major code: 4(ResrcOpProtected) Minor code:
2(NoCode)</status>
                <content>
                    <line type="auth.scheme.id">LDAPScheme</line>
                    <line type="auth.scheme.level">2</line>
                    <line type="auth.scheme.required.creds">2</line>
                    <line type="auth.scheme.redirect.url">http://
emerald.uk.example.com:14100/oam/server/</line>
                </content>
            </response>
        </case>
        <case uuid="009b44e3-1a94-4bfc-a0c3-84a38a9e0f2a">
            <request code="Authenticate">
                <uri getauthscheme="true">
                    <scheme>http</scheme>
                    <host>oam_server1</host>
                    <port>7777</port>
                    <resource>/index.html</resource>
                    <operation>Get</operation>
                </uri>
                <identity>
                    <id>weblogic</id>
                    <password>00030d05101b050c42</password>
                    <certstore></certstore>
                    <ipaddr>192.168.1.8</ipaddr>
                </identity>
            </request>

```



```

        <response elapsed="187" code="Yes">
            <comment></comment>
            <status>Major code: 10(CredentialsAccepted) Minor code:
2(NoCode)</status>
            <content>
                <line type="user.dn">cn=weblogic,dc=uk,dc=example,dc=com</line>
            </content>
        </response>
    </case>
<case uuid="84fe9b06-86d1-47df-a399-6311990743c3">
    <request code="Authorize">
        <uri getauthscheme="true">
            <scheme>http</scheme>
            <host>oam_server1</host>
            <port>7777</port>
            <resource>/index.html</resource>
            <operation>Get</operation>
        </uri>
        <identity>
            <id>weblogic</id>
            <password>00030d05101b050c42</password>
            <certstore></certstore>
            <ipaddr>192.168.1.8</ipaddr>
        </identity>
    </request>
    <response elapsed="188" code="Yes">
        <comment></comment>
        <status>Major code: 8(Allow) Minor code: 2(NoCode)</status>
        <content/>
    </response>
</case>
<case uuid="61579e47-5532-42c3-bbc7-a00828256bf4">
    <request code="Validate">
        <uri getauthscheme="false">
            <scheme>http</scheme>
            <host>oam_server1</host>
            <port>7777</port>
            <resource>/index.html</resource>
            <operation>Get</operation>
        </uri>
    </request>
    <response elapsed="172" code="Yes">
        <comment></comment>
        <status>Major code: 4(ResrcOpProtected) Minor code:
2(NoCode)</status>
        <content/>
    </response>
</case>
</cases>
</oamtestscript>

```

26.7.4 Target Output File Containing Test Run Results

Here is an example was generated by running the Access Tester in command-line mode and specifying the script.xml file as input to execute the 4 captured test cases.

```
Dscript.scriptfile="script.xml" -jar oamtest.jar
```

Notice the various sections in the Example: Output File Generated During a Test Run. As shown in the execution log, this test run found no mismatches, and shows that 4 out of 4 requests matched.

Output File Generated During a Test Run

```
<?xml version="1.0" encoding="UTF-8" standalone="yes"?>
<oamtestscript xmlns="http://xmlns.example.com/idm/oam/oamtest/schema"
version="1.0">
  <history description="Generated from script 'script.xml' using agent 'agent1'"
createdon="2012-02-03T23:03:02.171-05:00" createdby="test_user"/>
  <control numthreads="1" numiterations="1" ignorecontent="false"
testname="oamtest" configfile=""/>
  <cases numcases="4">
    <case uuid="465a4fda-d814-4ab7-b81b-f3f1cd72bbc0">
      <request code="Validate">
        <uri getauthscheme="true">
          <scheme>http</scheme>
          <host>oam_server1</host>
          <port>7777</port>
          <resource>/index.html</resource>
          <operation>Get</operation>
        </uri>
      </request>
      <response elapsed="969" code="Yes">
        <comment></comment>
        <status>Major code: 4(ResrcOpProtected) Minor code:
2(NoCode)</status>
        <content>
          <line type="auth.scheme.id">LDAPScheme</line>
          <line type="auth.scheme.level">2</line>
          <line type="auth.scheme.required.creds">2</line>
          <line type="auth.scheme.redirect.url">http://
emerald.uk.example.com:14100/oam/server/
</line>
        </content>
      </response>
    </case>
    <case uuid="009b44e3-1a94-4bfc-a0c3-84a38a9e0f2a">
      <request code="Authenticate">
        <uri getauthscheme="true">
          <scheme>http</scheme>
          <host>oam_server1</host>
          <port>7777</port>
          <resource>/index.html</resource>
          <operation>Get</operation>
        </uri>
        <identity>
          <id>weblogic</id>
          <password>00030d05101b050c42</password>
          <certstore></certstore>
          <ipaddr>111.222.3.4</ipaddr>
        </identity>
      </request>
      <response elapsed="187" code="Yes">
        <comment></comment>
        <status>Major code: 10(CredentialsAccepted) Minor code:
2(NoCode)</status>
        <content>
          <line type="user.dn">cn=weblogic,dc=us,dc=oracle,dc=com</line>
        </content>
      </response>
    </case>
  </cases>
</oamtestscript>
```

```

</case>
<case uuid="84fe9b06-86d1-47df-a399-6311990743c3">
  <request code="Authorize">
    <uri getauthscheme="true">
      <scheme>http</scheme>
      <host>oam_server1</host>
      <port>7777</port>
      <resource>/index.html</resource>
      <operation>Get</operation>
    </uri>
    <identity>
      <id>weblogic</id>
      <password>00030d05101b050c42</password>
      <certstore></certstore>
      <ipaddr>111.222.3.4</ipaddr>
    </identity>
  </request>
  <response elapsed="172" code="Yes">
    <comment></comment>
    <status>Major code: 8(Allow) Minor code: 2(NoCode)</status>
    <content/>
  </response>
</case>
<case uuid="61579e47-5532-42c3-bbc7-a00828256bf4">
  <request code="Validate">
    <uri getauthscheme="false">
      <scheme>http</scheme>
      <host>oam_server1</host>
      <port>7777</port>
      <resource>/index.html</resource>
      <operation>Get</operation>
    </uri>
  </request>
  <response elapsed="171" code="Yes">
    <comment></comment>
    <status>Major code: 4(ResrcOpProtected) Minor code:
2(NoCode)</status>
    <content/>
  </response>
</case>
</cases>
</oamtestscript>

```

26.7.5 Statistics Document

The statistics file (`_stats.xml`) is generated together with the target output script during the test run identified in the Execution log.

The `script.xml` file was used as input to execute the 4 captured test cases. The test run found no mismatches, and shows that 4 out of 4 requests matched.

A sample statistics document is shown in the Example: Sample Statistics Document. The various sections that provide statistics for this run, which you can compare against statistics for an earlier "known good" run.

Sample Statistics Document

```

A sample statistics document is shown here. Notice,
<oamteststats xmlns="http://xmlns.example.com/idm/oam/oamtest/schema"
version="1.0">
  <history description="Generated from script 'script.xml' using agent

```

```
'agent1' createdon="2012-02-03T23:03:02.171-05:00" createdby="test_user"/>
<summary>
  <total>
    <nummatched>4</nummatched>
    <numtotal>4</numtotal>
    <avgelapsedsources>238</avgelapsedsources>
    <avgelapsedsdtarget>232</avgelapsedsdtarget>
  </total>
  <validate>
    <nummatched>2</nummatched>
    <numtotal>2</numtotal>
    <avgelapsedsources>578</avgelapsedsources>
    <avgelapsedsdtarget>570</avgelapsedsdtarget>
  </validate>
  <authenticate>
    <nummatched>1</nummatched>
    <numtotal>1</numtotal>
    <avgelapsedsources>187</avgelapsedsources>
    <avgelapsedsdtarget>187</avgelapsedsdtarget>
  </authenticate>
  <authorize>
    <nummatched>1</nummatched>
    <numtotal>1</numtotal>
    <avgelapsedsources>188</avgelapsedsources>
    <avgelapsedsdtarget>172</avgelapsedsdtarget>
  </authorize>
</summary>
<detail>
  <source>
    <validate>
      <yes>2</yes>
      <no>0</no>
      <error>0</error>
      <mismatch>0</mismatch>
      <elapsed>1156</elapsed>
    </validate>
    <authenticate>
      <yes>1</yes>
      <no>0</no>
      <error>0</error>
      <mismatch>0</mismatch>
      <elapsed>187</elapsed>
    </authenticate>
    <authorize>
      <yes>1</yes>
      <no>0</no>
      <error>0</error>
      <mismatch>0</mismatch>
      <elapsed>188</elapsed>
    </authorize>
  </source>
  <target>
    <validate>
      <yes>2</yes>
      <no>0</no>
      <error>0</error>
      <mismatch>0</mismatch>
      <elapsed>1140</elapsed>
    </validate>
    <authenticate>
      <yes>1</yes>
```

```

        <no>0</no>
        <error>0</error>
        <mismatch>0</mismatch>
        <elapsed>187</elapsed>
    </authenticate>
    <authorize>
        <yes>1</yes>
        <no>0</no>
        <error>0</error>
        <mismatch>0</mismatch>
        <elapsed>172</elapsed>
    </authorize>
    <target>
    </detail>
    <mismatch numcases="0"/>
</oamteststats>

```

26.7.6 Execution Log

This sample execution log was generated together with the target output script during a test run using `script.xml` to execute 4 test cases.

The test run found no mismatches, and shows that 4 out of 4 requests matched.

As you review this example, notice the information provided which is the same as the information you see in the Status Messages panel of the Access Tester. Notice the test cases, test name, connection configuration file, agent name, connection status, request validation status, authentication scheme, redirect URL, credentials expected, authentication status and user DN, session ID, authorization status, validation status, and summary statistics. Also notice that the target script and statistics document were generated by this run.

Execution Log

```

[2/3/12 11:02 PM][info] Setting up to run script 'script.xml'
[2/3/12 11:02 PM][info] Loading test cases and control parameters from script
[2/3/12 11:02 PM][info] Loaded 4 cases
[2/3/12 11:02 PM][info] Control data for this test run:
[2/3/12 11:02 PM][info] Test name : 'samplerun1'
[2/3/12 11:02 PM][info] Configuration file : 'config.xml'
[2/3/12 11:02 PM][info] Ignore content : 'false'
[2/3/12 11:02 PM][info] Loading server configuration from file
[2/3/12 11:02 PM][info] Loaded server configuration
[2/3/12 11:02 PM][info] Connecting to server as agent 'oam_agent1'
[2/3/12 11:03 PM][info][request] Connect : Yes
...
[2/3/12 11:03 PM][info] Test 'samplerun1' will process 4 cases
[2/3/12 11:03 PM][info][request] Validate : Yes
[2/3/12 11:03 PM][info] Authentication scheme : LDAPScheme, level : 2
[2/3/12 11:03 PM][info] Redirect URL :
http://oam_server1.uk.example.com:2100/server/
[2/3/12 11:03 PM][info] Credentials expected: 0x01 (password)
[2/3/12 11:03 PM][info][request] Authenticate : Yes
[2/3/12 11:03 PM][info] User DN : cn=admin1,dc=us,dc=company,dc=com
[2/3/12 11:03 PM][info] Session ID : -1
[2/3/12 11:03 PM][info][request] Authorize : Yes
[2/3/12 11:03 PM][info][request] Validate : Yes
[2/3/12 11:03 PM][info] Summary statistics
[2/3/12 11:03 PM][info] Matched 4 of 4, avg latency 232ms vs 238ms
[2/3/12 11:03 PM][info] Validate: matched 2 of 2, avg latency 570ms vs 578ms
[2/3/12 11:03 PM][info] Authenticate: matched 1 of 1, avg latency 187ms vs 187ms

```

```
[2/3/12 11:03 PM][info] Authorize: matched 1 of 1, avg latency 172ms vs 188ms  
[2/3/12 11:03 PM][info] Generated target script 'samplerun1_0302171__target.xml'  
[2/3/12 11:03 PM][info] Generated statistics log 'samplerun1_0302171__stats.xml'
```

26.8 Validating User Authentication without Password

Access Tester provides an Admin mode in which the user is authenticated without a password. Admin mode is set to true after validation of credentials of the user initiating the authentication request. The user submitting the request will be a system user and a delegated admin.

Use the following steps to test user Authentication and Authorization:

1. Start the Access Tester, as described in [Installing and Starting the Access Tester](#)
2. Click the **Admin case** icon. Figure illustrates the Access Tester console in Admin mode.

Oracle Access Manager Test Tool

File Edit Test Help

Server Connection

*Prim... IP Addr... slc08duk.us.oracle.com Port 5575 Max C... 1 *Age... oam wa 10a1752

Second... 1 Agent Pas...

Min C... 1 Timeout... 30000 Mode op...

Protected Resource URI

Sche... http *H... slc08duk.us.oracle.com Port 7777

Resource /index.html Operati... Get

User Identity

IP Address 192.168.1.8 *Username webloaic Password ***** ?

User Certificat... *Impersonate User User1

Status Messages

```
[7/26/16 3:09 AM][request][validate] yes
[7/26/16 3:09 AM][response] Authentication scheme : LDAPScheme, level : 2
[7/26/16 3:09 AM][response] Redirect URL : http://slc08duk.us.oracle.com:24828/oam/
[7/26/16 3:09 AM][response] Credentials expected : 0x4 (form)
[7/26/16 3:21 AM][request][authenticate] no
[7/26/16 3:21 AM][response] Action Type : FORWARD
[7/26/16 3:21 AM][response][action] AdminMode : true
[7/26/16 3:21 AM][response][action] impersonateUser : user1
[7/26/16 3:21 AM][response] Major code: 3(FatalError) Minor code: 2(NoCode)
```

Elapsed (... 971 Capture Q... Empty

3. Add relevant details to the **Server Connection** panel and click Connect, as described in [Establishing a Connection Between the Access Tester and the OAM Server](#)
4. Enter or import details into the **Protected Resource URI** panel and click Validate, as described in [Validating Resource Protection from the Access Tester Console](#)
5. In **User Identity** panel, enter the information needed to test authentication:
 - a. **Username:** Enter admin userID whose credentials are being validated.

- b. **Password:** Enter admin password whose credentials are being validated.
 - c. **Impersonate User:** Enter userID of the individual who needs to be authenticated without password.
- 6. Click **Authenticate** button to submit the request to the OAM server and look for a response in the Status Messages panel.
 - a. On Successful authentication, a green check mark appears beside the Authenticate button and appropriate message also appears in the **Status Messages** panel.
 - b. On failure, a red circle appears beside the Authenticate button and appropriate message also appears in the **Status Messages** panel.
- 7. After successful authentication click the **Authorize** button to submit the request to the OAM server. All relevant authorization conditions and responses are considered during this policy evaluation.
 - a. On Successful authorization, a green check mark appears beside the Authorize button and appropriate message also appears in the **Status Messages** panel.
 - b. On failure, a red circle appears beside the Authorize button and appropriate message also appears in the **Status Messages** panel.

Configuring Centralized Logout for Sessions Involving 11g WebGates

You can use the Access Manager single logout (also known as global logout) for sessions that involve 11g WebGates. With Access Manager, single logout refers to the process of terminating an active session. Oracle recommends that you use the logout mechanism that is provided by Access Manager in the manner described in the following topics (not custom logout scripts).

The following topics describe how to configure centralized logout for sessions with 11g WebGates:

- [Prerequisites for the Configuration of Centralized Logout Sessions Involving 11g WebGates](#)
- [Introduction to Centralized Logout for Access Manager 11g](#)
- [Configuring Centralized Logout for 11g WebGates](#)
- [Validating Global Sign-On and Centralized Logout](#)

See Also:

Different agents require different logout implementation steps described as follows:

- 10g Webgate logout
See [Configuring Centralized Logout for 10g WebGate with 11g OAM Servers](#).
 - OSSO Agent (mod_osso) logout.
See [Understanding OSSO Agents with Access Manager](#)
-

27.1 Prerequisites for the Configuration of Centralized Logout Sessions Involving 11g WebGates

Before you can perform tasks in this chapter:

- The application must be deployed on the Web server where the agent is configured and registered with Access Manager
- One OAM Agent, on any supported Web server and platform, must be running and registered with Access Manager 11g ([Registering and Managing OAM 11g Agents](#))

- Policies must be configured to protect the resource in an Access Manager 11g Application Domain ([Managing Policies to Protect Resources and Enable SSO](#))

27.2 Introduction to Centralized Logout for Access Manager 11g

Unless explicitly stated, information in this chapter applies to OAM 11g WebGate Agents using the default embedded credential collector (ECC).

This section provides the following topics:

- [About Centralized Logout for 11g WebGates](#)
- [About Logout Parameters for 11g WebGates](#)

27.2.1 About Centralized Logout for 11g WebGates

Access Manager provides centralized logout (also known as global log out) for sessions.

Centralized logout refers to the process of terminating an active session, which means that:

- Applications must not provide their own logout page for use in an SSO environment.
- Applications must make their logout links configurable with a value that points to the logout URL specified by the WebGate Administrator.

Note:

Oracle strongly recommends that applications use the ADF Authentication servlet, which interfaces with OPSS where a domain-wide configuration parameter can be used to specify the logout URL. This way applications need not be modified or redeployed to change logout configuration.

Unlike partner applications, external applications (Yahoo! Mail, for example), do not delegate authentication to OAM and do not cede logout control to the OAM single sign-on server. It is the user's responsibility to log out of each of these applications.

[Table 27-1](#) describes the circumstances under which centralized logout occurs. When the logout URL is encountered and the cookie is removed (OAMAuthnCookie for 11g Webgates; ObSSOcookie for 10g Webgates). Webgate logs out the user and requires user re-authentication.

Table 27-1 Centralized Logout Circumstances

Circumstance	Description
Explicitly	<p>The client state is invalidated and the session ends. If a new attempt is made to access the resource, the client must re-authenticate.</p> <ul style="list-style-type: none">• When the user logs out.• When the Administrator terminates the session• When the session is terminated based on changes on the identity side

Table 27-1 (Cont.) Centralized Logout Circumstances

Circumstance	Description
Implicitly	<p>When no user activity occurs within the defined session timeout period, the user is logged out automatically and redirected back to the partner with a new session ID and a new prompt for credentials. This occurs if no lower-level authentication is configured for the resource.</p> <p>With Access Manager, the user is not logged out if 10g Webgate simply encounters a logout URL unless the <code>logout.html</code> provides an explicit redirection to the Server logout. The Webgate redirects the user to the Server logout.</p>

27.2.2 About Logout Parameters for 11g WebGates

Generally speaking, during centralized logout, the SSO Engine receives a `user-session-exists` request and sends out a `Session Cleared` response.

When the SSO Engine receives a `user-session-exists` request, the Session Management Engine looks up the session and responds with the `session-exists` response. The SSO engine sends a `Clear Session` request. The Session management engine clears the token and session context. The SSO engine then sends a `Session Cleared` response.

Clearing the user token and the session context clears the server-side state, which includes clearing the `OAM_ID` cookie set on the server side. When the agent is notified, the agent clears the client-side state of the application.

Configuring 11g WebGates for logout against OAM Servers requires a `Logout Callback URL` (Table 15-3). Centralized logout for 11g agents sets the cookie from `loggedout` to `empty` and expires `OAMAuthnCookie_<host:port>_<random number>` to explicitly clear it during logout, (rather than leaving behind an empty or logged out cookie).

The SSO Engine supports the central logout page on the OAM Server and:

- Calls back to `Logout Callback URL` of 11g Webgates during logout

The WebGate parameter `Logout Callback URL` can be configured using a URI format (recommended), without `host:port`. OAM Server dynamically constructs the full URL based on the `host:port` in the original request and calls back on it. This can also be a full URL format with a `host:port`, where OAM Server calls back directly without reconstructing callback URL.
- Lands on `end_url` (passed in as query parameter) after logout

Several elements in the 11g Webgate registration page enable centralized logout for 11g WebGates. After registration, the `ObAccessClient.xml` file is populated with the information in Table 27-2.

Table 27-2 Logout Details After Registration (ObAccessClient.xml)

Element	Description
Logout URL <i>10g and 11g WebGates</i>	<p>The Logout URL triggers the logout handler, which removes the cookie (ObSSOCookie for 10g Webgates; OAMAuthnCookie for 11g WebGates) and requires the user to re-authenticate the next time he accesses a resource protected by Access Manager.</p> <ul style="list-style-type: none"> • If there is a match, the WebGate logout handler is triggered. • If Logout URL is not configured the request URL is checked for "logout ." and, if found (except "logout.gif" and "logout.jpg"), also triggers the logout handler. <p>Default = [] (not set)</p> <p>Note: This is the standard 10g WebGate configuration parameter used to trigger initial logout through a customized local logout page as described in "Configuring Centralized Logout for 10g WebGate with 11g OAM Servers".</p>
<i>Additional Logout for 11g WebGate Only</i>	<p>For 11g WebGate single sign-off behavior, the following elements and values automate the redirect to a central logout URL, callback URL, and end URL. This replaces 10g WebGate single sign-off only through a customized local logout page.</p>
Logout Callback URL	<p>The URL to oam_logout_success, which clears cookies during the call back. This can be a URI format without <i>host:port</i> (recommended), where the OAM Server calls back on the <i>host:port</i> of the original resource request. For example:</p> <p>Default = /oam_logout_success</p> <p>This can also be a full URL format with a <i>host:port</i>, where OAM Server calls back directly without reconstructing callback URL.</p> <p>When the request URL matches the Logout Callback URL, Webgate clear its cookies and streams an image .gif in the response. This is similar to OSSO agent behavior.</p> <p>When Webgate redirects to the server logout page, it records an "end" URL as a query parameter (end_url=http://host:port/...), which becomes the landing page that the OAM Server redirects back to after logout.</p> <p>Note: In the remote registration template this parameter is named logoutCallbackUrl (Table 15-10).</p> <p>Other Oracle Access Management services support the central logout page on the server. The end_url relies on the target URL query parameter passed from OPSS integrated applications. See Also: "Configuring Centralized Logout for Oracle ADF-Coded Applications".</p>
Logout Redirect URL	<p>This parameter is automatically populated after agent registration completes. By default, this is based on the OAM Server host name with a default port of 14200. For example:</p> <p>Default = http://OAMServer_host:14200/oam/server/logout</p> <p>The Logout URL triggers the logout handler, which removes the OAMAuthnCookie_<host:port>_<random number> and requires the user to re-authenticate the next time he accesses a resource protected by Access Manager.</p> <ul style="list-style-type: none"> • When Webgate logout handler is triggered, it redirects to the central logout page specified by the Logout Redirect URL parameter if it is configured. • If this is explicitly cleared (and not configured), then 10g behavior is triggered. The local logout page can have a customized script to redirect to the central logout page and can clear additional 3rd party cookies if desired.

Table 27-2 (Cont.) Logout Details After Registration (ObAccessClient.xml)

Element	Description
Logout Target URL	<p>The value for this is name for the query parameter that the OPSS applications passes to Webgate during logout. This query parameter specifies the target URL of the landing page after logout.</p> <p>Default: end_url</p> <p>Note: The end_url value is configured using param.logout.targeturl in jps-config.xml.</p> <ul style="list-style-type: none"> • If Logout Target URL is configured, Webgate searches for the value passed in the logout request's query parameter and passes it as end_url query parameter in the redirect URL to OAM Server. • If Logout Target URL is not configured, Webgate searches for the default name "end_url" and passes that end_url query parameter along.

27.3 Configuring Centralized Logout for 11g WebGates

This section provides the following topics:

- [Configuring Centralized Logout for 11g WebGates When the ECC is Used](#)
- [Configuring Logout When Using Detached Credential Collector-Enabled WebGate](#)

See Also:

- ["Configuring Centralized Logout for 10g WebGate with 11g OAM Servers"](#)
 - ["Configuring Logout for OSSO Agents with Access Manager 11.1.2"](#)
 - ["Configuring Centralized Logout for Oracle ADF-Coded Applications"](#)
-
-

27.3.1 Configuring Centralized Logout for 11g WebGates When the ECC is Used

During 11g Resource WebGate registration or editing, you configure the logout parameters.

Note:

If the LogOutUrl parameter is already configured for the 11g WebGate (with a value other than /oamssso/logout.html), then ensure that is also present as part of the LogOutUrl parameter.

See Also:

["Configuring Logout When Using Detached Credential Collector-Enabled WebGate"](#)

To configure centralized logout for 11g WebGates:

1. Choose your method for registration described in [Registering and Managing OAM 11g Agents](#)
2. When creating or editing an agent registration, include appropriate logout values for your environment ([Table 27-2](#)):
 - Logout URL
 - Logout Callback URL
 - Logout Redirect URL
 - Logout Target URL
3. Finish and save your agent registration, as usual.
4. **Multiple DNS Domains:** Perform the following steps if you have multiple DNS domains configured for Access Manager 11g SSO.

Note:

The `Logout Callback URL` can be unique for each WebGate; however, to construct the `Logout Callback URL` for each WebGate, it is sufficient for the OAM Server to know the host and port of each WebGate from each domain. The file that the `Logout Callback URL` points to must differ from the `logout.html` script in the WebGate installation directory.

- a. Configure the `Logout Callback URL` as the second value in the `logOutUrLs` parameter on each resource WebGate.

`Logout Callback URL` is the location on WebGate that the request must be sent to, for clearing the SSO Cookie in that domain. The `Logout Callback URL` cannot be `logout.html`.

- b. Ensure that a file physically exists on each Web server at the `Logout Callback URL` location (usually, at the same location as `logout.html`).

For example, if you configure a file named `logout.png` in the same location as `logout.html`, then the `Logout Callback URL` of `logout.png` would be:

```
/oamssso/logout.png
```

5. Perform steps in "[Validating Global Sign-On and Centralized Logout](#)".

27.3.2 Configuring Logout When Using Detached Credential Collector-Enabled WebGate

When the DCC receives a logout request from the Agent, the DCC:

- Decrypts the logout request, if needed
- Retrieves the `end_url`, constructs the full URL with the Agent's `host:port` if needed
- Clears the DCC cookie (`DCCctxCookie`)
- Sends the logout request across the back channel to terminate the session

- Logout Callback URL Logout Callback URLs Gets a logout page containing links to all visited agent from OAM Sever (which has this information), or get only a list of the visited from OAM Sever to construct a logout page locally, and redirect user to this page on DCC.
- Returns to the end_url after logout completes

To configure logout for Resource Webgates separate from DCC:

1. Confirm that the Perl scripts for DCC logout include the actual location of the Perl executable on the Webgate host \$WEBGATE_HOME/oamsso-bin/*.pl.
2. **Resource Webgate:** Modify the Logout Redirect URL to point to DCC's logout.pl:
 - a. **Find the Resource Webgate Registration:** See "[WebGate Search Controls](#)".
 - b. Modify the Logout Redirect URL to point to the DCC's logout.pl. For example:

```
http://DCCWghost:port/oamsso-bin/logout.pl
```

Note:

The DCC ignores the Logout Redirect URL parameter in the Webgate registration page. However, if the Resource Webgate Logout Redirect URL is anything other than logout.*, then that URL must be defined in DCC Logout URLs. See [Table 24-3](#)

3. Perform steps in "[Validating Global Sign-On and Centralized Logout](#)".

27.4 Validating Global Sign-On and Centralized Logout

You can validate single sign-on global login with different applications, and centralized logout for single or two applications.

This section provides the following topics:

- [Confirming Global Sign-On](#)
- [Validating Global Sign-On with Mixed Agent Types](#)
- [Observing Centralized Logout](#)

27.4.1 Confirming Global Sign-On

You can observe single sign-on global login.

You must meet the following prerequisites:

- Agents and Servers must be registered with Access Manager and running
- Resources and policies controlling SSO must be defined within Access Manager Application Domains

To observe global sign-on:

1. From a browser, enter the URL to a protected resource.
2. On the login page, sign in using proper credentials.

3. Verify that the resource is presented; do not log out.
4. In the same browser window, enter the URL to another protected resource and confirm that the resource is presented without having to re-authenticate.

27.4.2 Validating Global Sign-On with Mixed Agent Types

You can observe single sign-on global login with different applications and agents that have the same authentication level.

For example, suppose you have:

- OSSO Partner at `http://host1.example.com:7777/private/index.html` protected using mod_osso
- Webgate Partner at `http://host2.example.com:8888/mydomain/finance/index.html` protected using OAM Agent

Within the same browser session, you can access all applications protected by either agent with only a single sign in.

You must meet the following prerequisites:

- Agents and Servers must be registered with Access Manager and running
- Resources and policies must be defined within Access Manager Application Domains
- Both partners must be protected at the same authentication level
- Single sign-on must be configured as described in this chapter

To observe global sign-on with mixed agent:

1. **OSSO Agent Protected Application:**
 - a. From a browser, enter the URL of the OSSO-protected resource
 - b. Confirm that the login page appears and sign in using proper credentials.
 - c. Confirm that the protected resource is served.
 - d. Remain in the same browser session and proceed to Step 2.
2. **Same Browser Session, OAM Agent Protected Application:**
 - a. In the same browser session as Step 1, enter the URL of the OAM Agent-protected resource.
 - b. Confirm that the protected resource is served and that no login page appears.
3. Log out of the browser session.
4. **Fresh Browser Session, OAM Agent Protected Application:**
 - a. In a fresh browser session, enter the URL of the OAM-protected resource.
 - b. Confirm that the login page appears and sign in using proper credentials.
 - c. Confirm that the protected resource is served.
 - d. Remain in the same browser session and proceed to Step 5.

5. Same Browser Session, **OSSO Agent Protected Application:**
 - a. In the same browser session as Step 4, enter the URL of the OSSO Agent-protected resource.
 - b. Confirm that the protected resource is served and that no login page appears.

27.4.3 Observing Centralized Logout

You can observe centralized logout with OAM Agents and with mod_osso.

- With OAM Agents, the logout URL redirects to the server and cookies are cleared and invalidated so that a subsequent request cannot locate the cookie.
- With mod_osso, each agent destroys its own cookies. The logout URL redirects to the global logout page on the server and each partner sends cookies to the server.

You must meet the following prerequisites:

- Agents must be registered and running
- Resources must be protected by Access Manager Application Domains
- Single sign-on must be configured with authentication and authorization policies and responses in Access Manager Application Domains

To observe centralized logout:

1. Single Application:

- a. From a browser, enter the URL of the protected resource.
- b. Confirm that the login page appears and sign in using proper credentials.
- c. Confirm that the protected resource is served.
- d. Open a new browser tab or window and access the same resource to confirm that the second attempt does not require another login.
- e. Logout from one tab.
- f. Access the resource again to confirm that a login page appears.

2. Two Applications:

- a. From a browser, enter the URL of the protected resource.
- b. Confirm that the login page appears and sign in using proper credentials.
- c. In a new tab or window, access another protected application and confirm that the second application does not require another login.
- d. Log out of the first application.
- e. Access the second application and confirm that the login page appears.

Part VII

Registering and Using Agents with Access Manager

When your enterprise includes Web server types other than Oracle HTTP Server, you can install 10g WebGates to use with Access Manager.

Part VI contains the following chapters:

- [Registering and Managing Legacy OpenSSO Agents](#)
- [Registering and Managing Legacy OSSO Agents](#)
- [Registering and Managing 10g WebGates with Access Manager 11g](#)
- [Configuring Apache, OHS, IHS for 10g WebGates](#)
- [Configuring the ISA Server for 10g WebGates](#)
- [Configuring the IIS Web Server for 10g WebGates](#)
- [Configuring Lotus Domino Web Servers for 10g WebGates](#)

Registering and Managing Legacy OpenSSO Agents

If OpenSSO has already been implemented as the enterprise solution for an existing Oracle deployment, Oracle Fusion Middleware continues to support this implementation as a solution. Additionally, you can register existing OpenSSO agents for use with Access Manager.

The following topics explain how to register or manage legacy OpenSSO agents for use with Access Manager 11.1.2:

- [Introduction to OpenSSO, Agents, Migration and Co-existence](#)
- [Runtime Processing Between OpenSSO Agents and Access Manager](#)
- [Understanding OpenSSO Agent Registration Parameters](#)
- [Registering and Managing OpenSSO Agents Using the Console](#)
- [Performing Remote Registration for OpenSSO Agents](#)
- [Open SSO Remote Registration versus Remote Updates](#)
- [Other OpenSSO Agent Information in this Guide](#)

28.1 Introduction to OpenSSO, Agents, Migration and Co-existence

OpenSSO is the open source version of the Sun Access Management, Federation Management, and Web Services Security product.

Each OpenSSO Agent is a filter that is plugged into a container (Oracle WebLogic Server, JBoss, Apache, and so on) that hosts applications. OpenSSO Agents can co-exist together with Webgates, Access Clients, or OSSO Agents. Oracle provides OpenSSO Assessment and OpenSSO Migration tools that you can use to transition existing OpenSSO agents, profiles, and policies in to Access Manager.

See Also:

Oracle Fusion Middleware Upgrade Guide for Oracle Identity and Access Management for details about Oracle-provided tools and processes to assess and transition OpenSSO agents, profiles, and policies in to Access Manager.

Each OpenSSO Agent provides restricted access to applications by intercepting requests to these applications. After provisioning, OpenSSO Agents use OAM Server instead of the OpenSSO Server.

Note:

OpenSSO Agents must be registered with Access Manager to use OAM Server instead of the OpenSSO Server.

After provisioning, OpenSSO Agents use OAM Server instead of the OpenSSO Server. Restricted access to applications is provided by intercepting requests to these applications. OAM Server provides an OpenSSO Proxy that enables communication between the agent and OAM Server and facilitates SSO to the agent-protected application.

OAM Server provides an OpenSSO Proxy that enables communication between the agent and OAM Server and facilitates SSO to the agent-protected application. Using registered OpenSSO Agents, Access Manager provides the features outlined in [Table 28-1](#) (authentication features and a subset of authorization features).

Table 28-1 Features: OpenSSO Agents with Access Manager

OpenSSO Agents	Access Manager
Agent Authentication	User Authentication
User Single-Sign-On	User Single Logout
SSO in mixed agents case (between OpenSSO agent and WebGate agent)	User Authorization
Self and Sub-tree mode search	Policy Conditions (Identity, LDAP filter, Session attribute, IP Range, Temporal)
User profile attributes retrieval	Centralized Agent configuration with REST request or response
Migration of Agent profiles, Policies, User Stores, Authentication Stores	Migration Assessment tool

For more information, see:

- [About Migration and Co-existence Between OpenSSO and Access Manager](#)
- [OpenSSO Agent Reliance on Access Manager](#)
- [Runtime Processing Between OpenSSO Agents and Access Manager](#)

28.1.1 About Migration and Co-existence Between OpenSSO and Access Manager

Access Manager supports co-existence with an existing OpenSSO Server deployment that has been migrated using the OpenSSO to Access Manager upgrade tool.

The OpenSSO to Access Manager Upgrade makes use of OpenSSO Discovery Agents and Policy mapping logic, which fulfills requirements described in following topics:

- [OpenSSO Policy Migration](#)
- [Application Domain Creation During OpenSSO Migration](#)
- [OpenSSO Authentication Policy Migration](#)

- [Host Identifier Creation in Access Manager](#)

For System Requirements and Supported Platforms for Access Manager and OpenSSO, see the Oracle Identity and Access Management matrix on the following site:

<http://www.oracle.com/technetwork/middleware/ias/downloads/fusion-certification-100350.html>

See Also:

Oracle Fusion Middleware Upgrade Guide for Oracle Identity and Access Management

28.1.1.1 OpenSSO Policy Migration

The OpenSSO policy is mapped to Access Manager authentication and authorization policies based on available artifacts in the OpenSSO deployment.

[Table 28-2](#) table outlines the mapping that occurs between OpenSSO and Access Manager during Policy migration.

See Also:

["Migrated Artifacts: OpenSSO"](#)

Table 28-2 OpenSSO Policy Migration

Serial	OpenSSO	Access Manager
1	Policy Realm	Policy Domain
2	Policy	Authentication and Authorization Policies
3	Resources	Resources plus Host Identifier
4	Actions	Not specified (By default only "GET")
5	Subject	Identity Conditions in Authorization Policies
6	Conditions	Authentication Scheme plus Authorization Conditions
7	Response Providers	Policy Responses

28.1.1.2 Application Domain Creation During OpenSSO Migration

If an existing Access Manager Application Domain and policies do not match an OpenSSO policy domain, a new Application Domain is created in Access Manager.

The created Application Domain corresponds to an OpenSSO Realm. With respect to each Realm, (OpenSSO Top-level and Sub -level Realms), an Application Domain is created in Access Manager.

All existing Application Domains are compared against OpenSSO Policy Domains. The policy name is checked against all existing policies. If a policy of the same name exists, an error occurs. Otherwise, a new policy is created in Access Manager.

Note:

An OpenSSO policy referral policy is not migrated.

28.1.1.3 OpenSSO Authentication Policy Migration

An OpenSSO policy containing valid rules and conditions is migrated to an Access Manager Authentication Policy: either a new policy to be created or an existing policy to be updated.

During policy creation, the OpenSSO policy rule *host:port* information is used to create the host identifier and exact resource URL (or URI) to the Application Domain.

Note:

An OpenSSO policy containing artifacts with no rules is not a valid policy.

A policy with conditions is valid for OpenSSO. However, these are migrated based on the default Authentication Policy for Access Manager. Such policies with IP or Temporal conditions can be migrated to Access Manager Authorization Policy conditions.

If the OpenSSO policy is a non-referral policy, an Access Manager Authentication Policy is created containing an authentication scheme with the corresponding authentication module from OpenSSO, host identifier, and resources from OpenSSO policy. In the Access Manager Authorization policy, corresponding OpenSSO constraints and subjects are set.

Limitation: Authentication policy creation exception if the resource already exists (in one of the policy in same Application Domain or Realm. If the resource is already protected by another policy (already exists under the host identifier), new policy creation for the same resource causes an exception. This new policy is not created. The errors are logged in a log file and also displayed in the Oracle Access Management Console.

28.1.1.4 Host Identifier Creation in Access Manager

One Host Identifier is created within Access Manager for each unique *host:port* combination from OpenSSO.

Need to retrieve all the *host:port* from each policy rules in each realm and will create the number of hostIdentifiers = number of unique *host:port* combinations.

Top Realm: By default, OpenSSO has only one top-level realm (/). All other realms can be created under this top-level realm. Ideally, the top-level realm will contain all the *host:port* combinations for which Host Identifiers are created in Access Manager.

Sub Realm: *host:port* combinations in policy rules within sub realms depend on the *host:port* in the Referral policy created under the top realm. The *host:port* in referral policy is not necessarily from any of the *host:port* in other non-referral policies in top realm (also referral policy is not applicable for migration). Hence, the *host:port* in sub realm's policies can be different from the *host:port* in top realm's policies which are applicable for migration. The *host:port* from each realm's policies is checked.

Limitation: In OpenSSO, if there are 2 (or more) policies with same rule yet with different authentication schemes to protect the same resource, then only one (the first

one in occurrence) can be migrated to Access Manager; the others are ignored and are not created in Access Manager. There are rare chances for such an occurrence.

28.1.2 OpenSSO Agent Reliance on Access Manager

The Oracle Access Manager supports OpenSSO Agents and processing.

The OAM components for OpenSSO are outlined in ["Table 28-3"](#).

Table 28-3 OpenSSO Reliance on Access Manager

Component	Description
OpenSSO Agent	<p>OpenSSO agents must be registered with Access Manager to establish trust by authenticating themselves. The OAM Server:</p> <ul style="list-style-type: none"> • Authenticates the agents with the credentials provided. • Creates a session for the agent. • Stores this information in the cache so that any server in the group/cluster can service the next request from the agent. • Passes the session identifier to the agent so that it can present this to OAM Server during subsequent interactions. <p>This agent session does not expire, which enables the Agent to maintain trust continuity with the OAM Server.</p> <p>The agent registration can be enabled or disabled. When disabled, the Agent does not respond.</p> <p>Multiple OpenSSO agents can share same centralized configuration (if required and if registered in centralized configuration mode). Even so, each agent has its own unique session and session ID. The agent registration can be configured for the "maximum number of agent sessions allowed" per registration.</p> <p>It might have a session timeout property that defines whether the agent's session should expire or not.</p> <p>See Also: "Registering and Managing OpenSSO Agents Using the Console " "Understanding Credential Collection and Login "</p>
OpenSSO Proxy	<p>This Oracle-provided proxy is bundled and installed with Access Manager 11.1.2. OpenSSO Proxy enables communication between the OpenSSO Agent and OAM Server. OpenSSO Proxy serves all OpenSSO Agent requests and responses for Authentication, Authorization, and SSO. OpenSSO Proxy provides protocol binding and message (request or response) conversion functionality.</p> <p>See Also: "Runtime Processing Between OpenSSO Agents and Access Manager"</p>
Protocol Binding Layer	<p>This Oracle-provided framework is responsible for agent-specific protocol handling and mapping authentication protocol messages. This framework also unmarshals incoming protocol-specific requests to protocol agnostic requests and marshals back protocol-agnostic responses to protocol-specific responses.</p>
Partner and Trust Store	<p>Stores OpenSSO Agent centralized configuration. The Access Manager Partner and Trust Store also supports Agent authentication by providing GET APIs for the Agent ID and Agent Password.</p>
OpenSSO Application Domain	<p>This can be generated automatically by using the Auto Create Policies option during OpenSSO Agent registration.</p>

Table 28-3 (Cont.) OpenSSO Reliance on Access Manager

Component	Description
Cookies	<p>The end user has the following valid cookies:</p> <ul style="list-style-type: none"> • OAM_ID cookie (represents the end session after agent authentication); see • OpenSSO cookie (the agent finds this cookie after the OpenSSO Proxy triggers session validation). The default name of the OpenSSO cookie is: iPlanetDirectoryPro
Authorization Policy for Protected Resources	<p>Set up the Authorization policy with</p> <ul style="list-style-type: none"> • An IP Range Condition that allows access to only the specified range of IP Addresses. • A Temporal Condition that allows access to only during the specified time period. • An Identity Condition that allows only the configured Identity (user or group) to access the protected resource. • An LDAP Filter condition that allows access only if the filter condition is satisfied. • A Session attribute condition that allows access only if the session has the configured session attribute with required value • An attribute condition for namespaces Request, User, and Session that allows access only if the attribute has been configured with required values
SSO Controller	<p>Fulfills protocol requests by invoking functional components (SSO Engine, Authentication Engine, and so on):</p>
SSO Engine	<p>Provides enterprise and same domain Sign-on and Single logout (SLO) during an online session.</p> <p>Manages the session lifecycle. Facilitates Global logout by orchestrating logout across all Relying Parties in the valid session. Communicates with the Token Processing Engine to create a valid session and persist the user.</p>

Table 28-3 (Cont.) OpenSSO Reliance on Access Manager

Component	Description
Session Management Engine	<p>Manages session and token context information with support for user- and Administrator-initiated and time-out based events. The SSO Engine uses Session Management Engine capabilities for session management:</p> <ul style="list-style-type: none"> • Create Session • Read Session • Update Session • Delete Session • Validate Session • Get Session Id • Set/Get creation instant • Set/Get expiry instant • Set/Get Last access time • Set/Get Session state • Purge Sessions <p>Note: There is no support for viewing or managing OpenSSO agent sessions using the Oracle Access Management Console. The OpenSSO engine controller layer invokes the appropriate session management interfaces as required. Session manager invokes the agent session cache manager internally to manage the distributed cache for the agent session.</p> <p>A unique session is created for each registered OpenSSO agent, which becomes the trust mechanism between the Agent and the OAM Server. The unique session ID accompanies all XML/HTTP requests for session validation, user authorization, and so on, as the agent token that must be validated by the OAM Server before it can serve any user requests.</p> <p>By default, the agent session does not expire. Agent sessions are stored within the in-memory session cache. Agent sessions are not required to be persisted if the OAM Server restarts.</p> <p>The agent session resides on the OAM Server and the unique agent session ID is passed back to Agent in a form it can use. The agent session supports two states: Invalid (unauthenticated), and Valid (authenticated). The OAM Server can successfully communicate with only an agent with a Valid session state.</p>
Token Processing Engine	<p>Responsible for token generation and token validation in response to token issuance and validation protocol requests. Default capability manages (issues, validates, renews, cancels) Username, SAML, and X509 tokens. This can also be extended to handle custom tokens beyond out-of-box/default supported security token types.</p>
Oracle Access Management Console	<p>Administrators use the console to:</p> <ul style="list-style-type: none"> • Provision/register OpenSSO Agents • Manage an Application Domain and authentication and authorization policies for protected resources.
Remote registration utility	<p>Administrators can use the remote registration utility to provision the agent and generate configuration files to be consumed by the agent in Centralized mode. The agent has a copy of all required configuration information and does not contact the OAM Server for this.</p> <p>Note: If you are migrating an OpenSSO agent profile to Access Manager, both localized and centralized modes are supported.</p>
WLST commands	<p>Administrators can use WLST commands to:</p> <ul style="list-style-type: none"> • Migrate OpenSSO Agents to the OAM Server <p>See Also: "Migrated Artifacts: OpenSSO".</p>

28.2 Runtime Processing Between OpenSSO Agents and Access Manager

The OAM Server includes an OpenSSO Proxy to handle communication with the OpenSSO Agent and facilitate interoperability with the OpenSSO server.

Single Sign On (SSO) and Single Logout (SLO) between OpenSSO policy agents and the OAM Server, for instance. Interoperability is accomplished by honoring HTML/HTTP Authentication requests for end-user authentication (as an HTTP redirect) and XML/HTTP SSO requests for end-user session validation.

Figure 28-1 shows a deployment that includes OpenSSO and Access Manager. The OpenSSO Agent resides with the Web/Java EE container and the protected resource. The OpenSSO Server resides on a different host.

Figure 28-1 Typical Deployment with OpenSSO and Access Manager

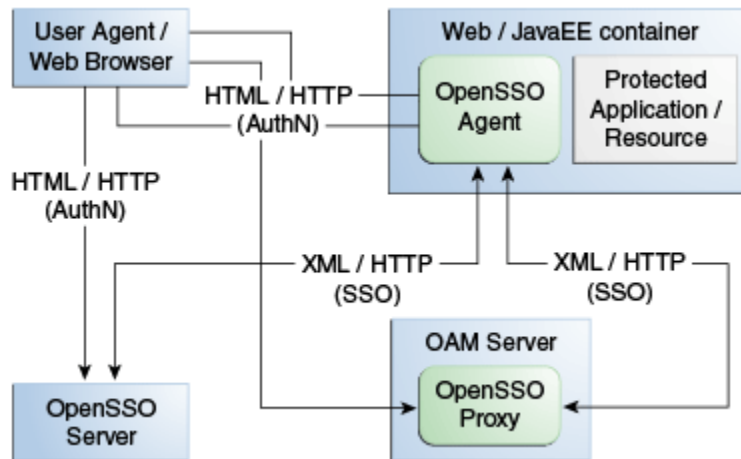

Table 28-4 describes SSO processing between Access Manager and OpenSSO Agents.

Table 28-4 Access Manager Processing with OpenSSO

Functionality	Description
OpenSSO Agent Authentication	<p>OpenSSO agents are authenticated and a valid agent session is established before user authentication.</p> <p>The OpenSSO agent authenticates itself to the OAM Server through the OpenSSO Proxy.</p> <p>OpenSSO Agent Authentication (Agent authenticating itself to the OpenSSO Proxy occurs based on the Agent type:</p> <p style="padding-left: 40px;">J2EE Agents: Upon Agent container startup. Web Agents: With the first user authentication request to the Web Server.</p> <ol style="list-style-type: none"> 1. End user sends a request to access an application or resource protected by the OpenSSO agent. 2. OpenSSO agent redirects this un-authenticated user to the OAM Server for authentication as follows: <ul style="list-style-type: none"> J2EE Agents: Upon Agent container startup. Web Agents: With the first user authentication request to the Web Server. 3. Agent sends the naming request to the proxy to fetch all the other service URLs (Authentication service, Session Service, and so on). 4. Agent sends the xml Authentication request to the Proxy with its credentials on the Authentication service endpoint (obtained from the naming request in Step 3). 5. Proxy authenticates the Agent against an Agent authentication module and creates a non-expiry session in the proxy layer itself. 6. Proxy sends the Authentication xml Response with the agent session details to the agent over http. <p>Once the agent is authenticated, a valid agent session is created. The key that is generated following agent authentication is stored in the Partner and Trust store.</p>

Table 28-4 (Cont.) Access Manager Processing with OpenSSO

Functionality	Description
SSO User Login and Authentication	<p>After the agent is authenticated by the OAM Server, the user request is authenticated by the OAM Server. SSO is then provided to the authenticated user accessing resources protected by the agent.</p> <p>After the OpenSSO agent is authenticated and logged in, the agent verifies whether the user has an OpenSSO cookie. If not, the user authentication request is initiated from the OpenSSO agent.</p> <p>User Login</p> <ol style="list-style-type: none"> 1. OpenSSO agent intercepts the request to protected application. OpenSSO agent checks if the user has an OpenSSO cookie. If not, OpenSSO agent redirects the user to the OpenSSO Proxy for authentication service. OpenSSO Proxy fetches the requested resource URL and the agent ID. 2. The OpenSSO Login event in the OpenSSO proxy wraps this request in a way that the core login events can understand. The OpenSSO login event passes the resource URL and the agent ID to the core login event. 3. Core Login events are performed, which checks if the request object contains an OAM_ID cookie. If yes, OAM Server checks if the session represented by the OAM_ID cookie is a valid session. 4. If the session represented by the OAM_ID cookie is valid, core login event returns the Login response event, which is wrapped by the OpenSSO Login event and is passed on to the OpenSSO login response handler. Core login event returns the identifier of the validated session. 5. OpenSSO login response handler (part of OpenSSO proxy) creates an OpenSSO session identifier in the format that the OpenSSO agent understands and extends this identifier with the OAM session identifier. OpenSSO cookie is created, which contains the OpenSSO session identifier and this cookie is set in the user's browser.

Table 28-4 (Cont.) Access Manager Processing with OpenSSO

Functionality	Description
End User Session Validation	<p data-bbox="542 321 1252 380">OpenSSO agents intercept the request to the protected application. End user Session Validation</p> <ol data-bbox="542 411 1455 1209" style="list-style-type: none"> <li data-bbox="542 411 1455 470">1. OpenSSO agent intercepts the request to the protected application and finds an OpenSSO cookie. <li data-bbox="542 491 1455 579">2. OpenSSO agent constructs an XML/HTTP request to validate this OpenSSO cookie. Here XML request would have Application / Agent token ID and session ID. This request reaches the OpenSSO proxy layer. <li data-bbox="542 600 1455 659">3. OpenSSO Proxy gets the Application Token associated with the request and validates the Application Token with the OAM Server. <li data-bbox="542 680 1455 716">4. OAM Server validates the token and sends the response to the OpenSSO Proxy <li data-bbox="542 737 1455 825">5. If the Application Token is invalid, the OpenSSO proxy communicates that to the OpenSSO agent and OpenSSO agent starts the agent authentication flow to obtain that valid Application Token. <li data-bbox="542 846 1455 934">6. If the Application Token is valid, OpenSSO proxy decrypts the OpenSSO cookie, fetches the OpenSSO session ID and gets the OAM session ID which is stored as the extension in the OpenSSO session ID. <li data-bbox="542 955 1198 991">7. The OpenSSO Proxy triggers the session validation flow. <li data-bbox="542 1012 1455 1129">8. If the session represented by the OAM session ID valid, the OpenSSO proxy communicates that to the Agent and the protected application is displayed to the user. This session validation returns the session data (session attributes and values) to the proxy layer as the output of session validation event response. <li data-bbox="542 1150 1455 1209">9. If the session is invalid, authentication flow is initiated by the OAM Server, where the OAM Server collects the user credentials and validates the user.
User profile attributes retrieval for Web Agent types	<p data-bbox="542 1251 1455 1394">OpenSSO agents can request user profile attributes once the user is successfully logged in and a valid session is created, by providing the session ID. The OpenSSO proxy layer must receive these requests and fetch the OAM session ID from the OpenSSO session ID extension. OpenSSO Web agents use the Policy service URL for these requests.</p> <p data-bbox="542 1402 1455 1486">OpenSSO proxy then fetches these attributes and passes the session ID to the OAM Server (which uses the responses framework to fetch the User Profile attributes and return the data to the OpenSSO Proxy).</p>
User profile attributes retrieval for J2EE Agent types	<p data-bbox="542 1518 1455 1577">OpenSSO J2EE agents use jax-rpc calls to retrieve user profile attributes. The flow is similar as the one for Web agents types to retrieve these properties.</p>

Table 28-4 (Cont.) Access Manager Processing with OpenSSO

Functionality	Description
User Single Logout	<ol style="list-style-type: none"> 1. The OpenSSO Proxy receives a User logout request and forwards the user to the OAM logout URL 2. OpenSSO Proxy decrypts the OpenSSO cookie, fetches the OpenSSO session identifier and, from that, fetches the OAM session ID. OpenSSO proxy sends the logout request to controller through the OpenSSO logout event with the OAM session ID. 3. Core logout events are performed, which includes the controller calls to the SSO engine to confirm the session exists. If the session exists, the OAM_ID cookie is deleted, and global logout is performed. 4. The SSO engine returns the response to the controller indicating the session has been cleared. 5. The controller sends a request to the proxy to clear tokens. 6. The Proxy sends the request to the agent to clear tokens through the OpenSSO Logout response handler.
SSO Agent Logout	<p>Access Manager handles single logout requests originating from the OpenSSO agents.</p> <p>Note: The user must be logged out from resources protected by other agents (WebGate and MOD_OSSO, for instance). Agent logout is not required other than in the multi-domain environment.</p> <ol style="list-style-type: none"> 1. The OpenSSO Agent requests logout to OpenSSO Proxy. 2. The Proxy fetches the Application token from the request and verifies that the request is initiated by an authenticated agent. 3. OpenSSO Agent Logout is handled within the proxy as the session is created in an independent Agent Session Management Module. 4. The decrypted token is returned to the OpenSSO Proxy. If there is no OpenSSO token present, steps 2 and 3 are absent. 5. The OpenSSO Login event in the OpenSSO proxy wraps this request in a way that the core login events can understand. 6. Core Login events are performed, which includes forwarding the request to the SSO Engine through the controller and authenticating the user. A new session is created for the authenticated user. 7. Core login event returns the Login response event, which is wrapped by the OpenSSO Login event and is passed on to the OpenSSO login response handler. 8. OpenSSO login response handler sends the response to the OpenSSO agent.
Token Generation for OpenSSO Agents	Access Manager processes the tokens generated for, and to be consumed by the OpenSSO agents.

Table 28-4 (Cont.) Access Manager Processing with OpenSSO

Functionality	Description
Logging	Enables you to track events during end user access enforcement for following events, using the OAM Server log component: <ul style="list-style-type: none"> • Login success and login failure events • Logout success and logout failure events • Log messages at different logging levels (FATAL, ERROR, WARNING, DEBUG, TRACE), each of which indicates severity in descending order.
Auditing	Using the OAM Server audit component to: <ul style="list-style-type: none"> • Audit Login events • Audit Logout success events
Polling	Polling is not Supported. Only Session Destroy notifications are supported by the OpenSSO Proxy.

28.3 Understanding OpenSSO Agent Registration Parameters

Whether you migrate existing OpenSSO Agents to Access Manager or register a fresh OpenSSO Agent, the Oracle Access Management Console provides centralized registration and management of OpenSSO Agents.

- [OpenSSO Agent Registration Parameters](#)
- [The Expanded OpenSSO Agent Page and Parameters](#)

28.3.1 OpenSSO Agent Registration Parameters

Administrators can enter information in the New OpenSSO Agent page during new OpenSSO agent registration.

[Figure 28-2](#) shows the New OpenSSO Agent page.

Figure 28-2 Create OpenSSO Agent Page

[Table 28-5](#) describes the elements on the New OpenSSO Agent page.

Table 28-5 Elements on the New OpenSSO Agent Page

Element	Description
Agent Type	<p>OpenSSO agent types can be either:</p> <ul style="list-style-type: none"> • Web: Use with Web resources and Web resource URLs. • J2EE: Default agent type. Use J2EE type agents for Java EE resources and applications. <p>For the J2EE Agent, Filter modes must be set by choosing either: SSO_ONLY (Access Manager Authentication Only): Enables the least restrictive mode of operation for the filter; the agent simply ensures that all users who try to access protected web resources are authenticated.</p> <p>URL_Policy (Access Manager Authentication and Authorization): Enables the agent filter to enforce URL policies. By default, with Web Agents, <code>.com.sun.identity.agents.config.sso.onlyattribute</code> is set to "false".</p> <p>Note: Both agent types provide access protection when you also choose SSO only.</p>
Agent Name	Unique name for this agent.
Password Re-enter Password	<p>A required, unique password for this OpenSSO agent, which can be assigned during this registration process. The entry will appear in obfuscated format in the console, in <code>oam-config.xml</code>, and in <code>OpenSSOAgentBootstrap.properties</code>.</p> <p>When a registered agent connects to an OAM Server, the user is prompted for the password. The password is used for authentication to prevent unauthorized agents from connecting and obtaining policy information.</p>
Host Identifier	<p>A name that identifies the host and port for the OpenSSO agent.</p> <p>Default: <i>Agent Name</i></p> <p>See Also: "About Virtual Web Hosting".</p>
Base URL	<p>The protocol, host, and port of the computer on which the OpenSSO agent is installed.</p> <p>For example, <code>http://host.example.domain.com:port</code> or <code>https://example.domain.com:port</code>.</p>
Auto Create Policies	<p>During agent registration, you can have authentication and authorization policies created automatically. This option is checked (enabled) by default. The agent name is used as the Application Domain name by default.</p> <p>Default: Enabled</p> <p>See Also: "Generated Artifacts: OpenSSO".</p> <p>Notes: An Application Domain in Access Manager corresponds to a Realm in OpenSSO. If you already have an Application Domain and policies, you can simply add new resources to it. If you clear this option (no check), no Application Domain or policies are generated automatically.</p>

OpenSSO Agent Properties

OpenSSO Agent properties are stored in the following files, which are updated during agent registration and configuration changes and consumed during run time:

- OpenSSOAgentBootstrap.properties
- OpenSSOAgentConfiguration.properties

These files are stored on the console host (AdminServer) and must be relocated to the OpenSSO Agent /config directory as shown in [Table 28-6](#).

Table 28-6 Relocating OpenSSO Artifacts

From AdminServer . . .	To OpenSSO Agent /config Directory
<code>\$<MW_HOME>/Oracle_IDM1/oam/server/rreg/client/rreg/output</code>	<code>\$Policy-Agent-base/AgentInstance-Dir/config/</code>

For details about the generated Application Domain for an Open SSO Agent, see "[Generated Artifacts: OpenSSO](#)".

28.3.2 The Expanded OpenSSO Agent Page and Parameters

The expanded OpenSSO Agent page is available when managing the agent using the Oracle Access Management Console. During registration, only a small subset of available parameters is displayed to streamline the process.

Whether you registered the agent using the Oracle Access Management Console or the remote registration utility, you can view the full agent configuration page in the console. Default values populate the page after initial registration and are displayed when you open the Agent's page, as shown in [Figure 28-3](#).

Figure 28-3 Expanded OpenSSO Web Agent Registration Page

WebAgent1 OpenSSO Agent
Apply

General

Agent Type Web

Agent Name WebAgent1

Password

Re-enter Password

* Base URL

Status Enabled

* Realm Name

Session Timeout (In Seconds)

Max Sessions

* Cookie Name

Cookie Separator

SSO Only

URLs

Login URLs		Logout URLs		Not Enforced URLs	
Sr. No.	Login URL	Sr. No.	Logout URL	Sr. No.	Not Enforced URL
1	http://slc01mqd.us.oracle.com:1410	1	http://slc01mqd.us.oracle.c		

Access Denied URL

Audit

* Local Log File

* Debug File

User Mapping

User ID Param Type

User ID Param

Attribute Mapping

Profile Attributes		Response Attributes		Session Attributes	
Name	Custom Name	Name	Custom Name	Name	Custom Name
Fetch Mode	NONE	Fetch Mode	NONE	Fetch Mode	NONE

Miscellaneous

Sr. No.	Name	Value
1	com.sun.identity.agents.config.repository	centralized
2	com.sun.identity.agents.config.audit.acce	LOG_NONE
3	com.sun.identity.agents.config.log.dispo	LOCAL
4	com.sun.identity.client.notification.url	http://webagent1.company.com:7001/UpdateAgentCacheServlet?shortcircuit=false
5	com.sun.identity.agents.config.fqdn.defau	webagent1.company.com
6	com.sun.identity.agents.config.fetch.from	false
7	com.sun.identity.agents.config.debug.lev	all:1
8	com.sun.identity.agents.config.agenturi.p	http://webagent1.company.com:7001/amagent
9	com.sun.identity.agents.config.notification	true
10	com.sun.identity.agents.config.policy.cloc	0
11	com.sun.identity.agents.config.change.n	true

Information on the J2EE Agent registration page is nearly the same as details for Web Agents. The J2EE Agent registration page is shown in [Figure 28-4](#).

Figure 28-4 Expanded OpenSSO J2EE Agent Registration Page

MyJ2EE-1 OpenSSO Agent
Apply

General

Agent Type J2EE

Agent Name MyJ2EE-1

Password

Re-enter Password

* Base URL

Status Enabled

Filter Mode URL_POLICY

* Realm Name

Session Timeout (In Seconds)

Max Sessions

* Cookie Name

Cookie Separator

Enable Cookie Encoding

URLs

Login URLs		Logout URLs		Not Enforced URIs	
Sr. No.	Login URL	Sr. No.	Logout URL	Sr. No.	Not Enforced URI
1	http://slc01mqd.us.oracle.com:14100	1	http://slc01mqd.us.oracle.c		

Access Denied URI

Audit

Debug Level Error

* Debug Directory

* Local Log File

User Mapping

Mapping Mode USER_ID

User Identity User Token

Attribute Name

Attribute Mapping

Profile Attributes		Response Attributes		Session Attributes	
Name	Custom Name	Name	Custom Name	Name	Custom Name
Fetch Mode NONE		Fetch Mode NONE		Fetch Mode NONE	

Miscellaneous

Sr. No.	Name	Value
1	com.sun.identity.agents.config.repository	centralized
2	com.sun.identity.agents.config.audit.acce	LOG_NONE
3	com.sun.identity.agents.config.log.dispo	LOCAL
4	com.sun.identity.client.notification.url	http://j2ee1.company.com:7001/agentapp/notification
5	com.sun.identity.agents.config.fqdn.defa	j2ee1.company.com
6	com.sun.identity.agents.config.load.inten	3600
7	com.sun.identity.agents.config.legacy.red	/agentapp/sunwLegacySupportURI
8	com.sun.identity.agents.polling.interval	3
9	com.sun.identity.policy.client.cacheMode	self
10	com.sun.identity.policy.client.booleaActi	iPlanetAMWebAgentService GET allow deny;iPlanetAMWebAgentService POST allow deny
11	com.sun.identity.policy.client.resourceCo	serviceType=iPlanetAMWebAgentService class=com.sun.identity.policy.plugins.HTTPURLResourceName wildcard=* d
12	com.sun.identity.policy.client.clockSkew	0
13	com.sun.identity.agents.config.change.nl	true

Table 28-7 describes all elements on expanded OpenSSO Agent registration pages.

Table 28-7 Expanded OpenSSO Agent Registration Elements

Element	Description
Status	The state of this agent registration: Enabled or Disabled. Default: Enabled See Also: Table 28-5

Table 28-7 (Cont.) Expanded OpenSSO Agent Registration Elements

Element	Description
Filter mode <i>J2EE Agent Type only</i>	<p>The Agent filter is installed within the protected application. It facilitates the enforcement of security policies, governing the access to all resources within the protected application. Every application protected by the J2EE Agent must have its deployment descriptors changed to reflect that it is configured to use the agent filter. Applications that do not have this setting are not protected by J2EE the Agent and might malfunction or become unusable if deployed on a deployment container where the Agent realm is installed.</p> <p>Filter modes must be set for the J2EE Agent by choosing one of the following options: SSO_ONLY or URL_Policy.</p> <p>Default: URL_Policy</p> <ul style="list-style-type: none"> • SSO_ONLY (Access Manager Authentication Only): Enables the least restrictive mode of operation for the filter; the agent simply ensures that all users who try to access protected web resources are authenticated. • URL_Policy (Access Manager Authentication and Authorization): Enables the agent filter to enforce URL policies. By default, with Web Agents, <code>.com.sun.identity.agents.config.sso.onlyattribute</code> is set to "false". <p>Process overview: Authentication Only (SSO_ONLY J2EE Filter Mode)</p> <ol style="list-style-type: none"> 1. End user requests access to an application or resource protected by OpenSSO Agent. 2. OpenSSO Agent redirects this un-authenticated user to OAM Server for authentication. 3. After successful authentication, OpenSSO Proxy redirects the user back to the protected resource with OpenSSO session ID set in the response cookie. 4. Authenticated end user with valid OpenSSO session, accesses application or resource protected by OpenSSO Agent. 5. OpenSSO Agent validates the OpenSSO Session against OAM Server through the OpenSSO Proxy and enables SSO for the end user. 6. End user gets access to the protected application or resource. <p>Process overview: Authentication and Authorization with URL_Policy J2EE Filter Mode</p> <ol style="list-style-type: none"> 1. End user requests access to an application or resource protected by OpenSSO agent. 2. OpenSSO Agent redirects this un-authenticated user to OAM Server for authentication. 3. After successful authentication, OpenSSO Proxy redirects the user back to the protected resource with OpenSSO session ID set in the response cookie. 4. Authenticated end user with valid OpenSSO session, accesses application or resource protected by OpenSSO Agent. 5. OpenSSO Agent validates the OpenSSO Session against OAM Server through the OpenSSO Proxy. 6. OpenSSO Agent sends Policy requests to OAM Server through the OpenSSO Proxy to ensure the authenticated user is authorized to access the resource. 7. OpenSSO Proxy evaluates the Policies for the protected resource (using OAM Policy Engine) and sends the Policy decision to the Agent: Allow or Deny. 8. End user gets access if the Policy decision is Allow. <p>Note: The following Filter Modes are not supported: NONE, J2EE_Policy, All.</p>

Table 28-7 (Cont.) Expanded OpenSSO Agent Registration Elements

Element	Description
	See Also: " Understanding OpenSSO Agent Registration Parameters ".
Session Timeout in seconds (User)	Click the arrows to specify the period, after which the session times out and the user must re-authenticate. You must set "Max Sessions" to a non-zero value to enable this setting. Default: 0
Max Sessions	Maximum number of sessions allowed per user. Default: 0
Cookie Name	The default name of the OpenSSO cookie is: Default: iPlanetDirectoryPro
Cookie Separator	Defines the character to be used as a separator when multiple values of the same attribute are being set as a cookie. For example, the pipe symbol " ", can be used. Default:
Enable Cookie Encoding <i>J2EE-type Agent Only</i>	Identifies whether cookie encoding is enabled or not. Default: Enabled
SSO Only <i>Web-type Agent Only</i>	Enables OpenSSO Agent to bootstrap and authenticate with the OAM Server using the OpenSSO proxy provided by Access Manager: The end user accesses the application or resource protected by the OpenSSO Agent, which redirects the unauthenticated user to the OAM Server for authentication. After successful authentication, the OpenSSO proxy redirects the user back to the protected application or resource and sets the OpenSSO Session ID in the response cookie. The authenticated user with a valid OpenSSO session accesses the application or resource protected by the OpenSSO Agent, which validates the session against the OAM Server using the OpenSSO Proxy. The end user gets access based on Access Manager authorization policy.
Urls	
Login URLs	Enter the login URL, which must include the appropriate protocol (HTTP or HTTPS), host, domain, and port in the following form: <code>http://example.domain.com:port</code> Default: <code>http://oamhost:port/opensso/UI/Login</code> Note: The port number is optional.
Logout URLs	The Logout URL triggers the logout handler, which requires the user to re-authenticate the next time he accesses a resource protected by Access Manager. When you enter the Logout URL, it must include the appropriate protocol (HTTP or HTTPS), host, domain, and port. For example: <code>http://example.domain.com:port/opensso/UI/Logout</code> Default: <code>http://oamhost:port/opensso/UI/Logout</code> Note: The port number is optional. The user must be logged out from resources protected by other agents (WebGate and MOD_OSSO, for instance). Agent logout is not required other than in the multi-domain environment.

Table 28-7 (Cont.) Expanded OpenSSO Agent Registration Elements

Element	Description
Not enforced URLs <i>Web-type Agent Only</i>	The URLs you enter in this list have no policy enforcement. These equate to Public URLs, with no protection and access is allowed by all.
Access Denied URI	The URI to which the user is directed if access to the requested resource is denied. This is available for both Web and J2EE Agents, each with its own format requirements: Web Agent (full URL): <code>http://host:port/context/accessDeniedURL.html</code> J2EE Agent (relative URI): <code>/context/accessDeniedURL.htm</code> Default: (blank)
Audit	
Debug Level <i>J2EE-type Agent Only</i>	When set, the OAM Server logs messages for: <ul style="list-style-type: none"> • Login success and login failure events • Logout success and logout failure events • Log messages at different logging levels (ERROR, WARNING, MESSAGE, each of which indicates severity in descending order. Default: Error See Also: Logging Component Event Messages
Debug Directory <i>J2EE-type Agent Only</i>	The filesystem directory path for audit logs from the OAM Server: <ul style="list-style-type: none"> • Audit Login events • Audit Logout success events See Also: Auditing Administrative and Run-time Events
Debug File <i>Web-type Agent Only</i>	Defines the filesystem directory path to the local component event logging file. Default:
Local Log File	Defines the filesystem directory path to the local component event logging file. Default:
User Mapping	
Mapping Mode	<ul style="list-style-type: none"> • HTTP_HEADER • USER_ID • PROFILE_ATTRIBUTE • SESSION_PROPERTY Default: User_ID
User Identity	Default: User ID
User Attribute Name	Default:

Table 28-7 (Cont.) Expanded OpenSSO Agent Registration Elements

Element	Description
Attribute Mapping	<p>Attribute retrieval fetches and sets user attributes in the HTTP request for consumption by the applications.</p> <p>The following Attribute Mapping panels are available:</p> <ul style="list-style-type: none"> • Profile Attributes • Response Attributes • Session Attributes <p>Fetch Mode: Certain applications rely on the presence of user-specific profile information in some form to process user requests appropriately. The agent can make these attributes from the user's profile available in various forms. when you specify a Fetch Mode for Profile, Response, or Session Attributes:</p> <ul style="list-style-type: none"> • NONE: No attributes are fetched. • HTTP_HEADER: When the agent is configured to provide the LDAP attributes as HTTP headers, these attributes can be retrieved. • REQUEST_ATTRIBUTE: When the agent is configured to provide the LDAP attributes as request attributes, the agent populates these attribute values into HttpServletRequest as attributes that can later be used by the application as necessary. For example, fetch profile attributes, assign a mode to the profile attribute property, and map the profile attributes to be populated under specific names for the currently authenticated user. • HTTP_COOKIE: When the agent is configured to provide the LDAP attributes as cookies, the necessary values are set as server specific cookies by the agent with the path specified as "/." Multi-valued attributes are set as a single cookie value such that all values of the attribute are concatenated into a single string using a separator character that can be specified by the property labeled Cookie Separator. <p>Default: None</p>
Profile Attributes	<p>User profile information can be populated under specific names for the currently authenticated user. For example:</p> <p>Fetch Mode: REQUEST_ATTRIBUTE</p> <p>Name (Map key): cn Value: CUSTOM-Common-Name</p> <p>Name (Map key): mail Value: CUSTOM-Email</p> <p>Default: No data</p>
Response Attributes	<p>Obtains user-specific information by fetching policy response attributes, assigns a mode to the policy response attribute property, and maps the policy response attributes to be populated under specific names for the currently authenticated user.</p> <p>Fetch Mode: REQUEST_ATTRIBUTE</p> <p>Name (Map key): cn Value: CUSTOM-Common-Name</p> <p>Name (Map key): mail Value: CUSTOM-Email_Addr</p> <p>Default: No data</p>

Table 28-7 (Cont.) Expanded OpenSSO Agent Registration Elements

Element	Description
Session Attributes	The attributes in the session object maintained by the OAM Server. These are sent as part of a session validation response to the Agents. Fetch Mode: REQUEST_ATTRIBUTE Name (Map key): UserToken Value: CUSTOM-userid Default: No data

Table 28-7 (Cont.) Expanded OpenSSO Agent Registration Elements

Element	Description
Miscellaneous	<p>Most agent properties are hot-swap enabled. Changing configuration properties can have unexpected results. Hot-swappable properties take effect immediately. Therefore, mistakes are instantly implemented. Most agent properties are presented in a format that is most useful for configuring using Oracle Access Management Console. However, this format is not used in the <code>OpenSSOAgentBootstrap.properties</code> file.</p> <p>List Properties: Certain properties are specified as lists composed of a key that represents the property name; a positive number (starting from 0) that increments by 1 for every value specified in the list; and a value. For example:</p> <pre>com.sun.identity.agents.config.notenforced.uri[0]=/agentsample/public/* com.sun.identity.agents.config.notenforced.uri[1]=/agentsample/images/* com.sun.identity.agents.config.notenforced.uri[2]=/agentsample/index.html</pre> <p>Map Constructs: Certain properties are specified as map constructs composed of a key that represents the property name; a name string that forms the lookup key as available in the map; and the value associated with the name in the map. For example:</p> <pre>com.sun.identity.agents.config.filter.mode[app1]=ALL com.sun.identity.agents.config.filter.mode[app2]=SSO_ONLY</pre> <p>Note: For a given name, there can only be one entry in the configuration for a given configuration key. If multiple entries with the same <name> for a given configuration key are present only one of the values will be loaded in the system and the other values are discarded.</p> <p>Application-Specific Properties: Certain properties can be configured for specific applications. Thee agent can use different values of the same property for different applications as defined in the configuration file. Application Specific configuration properties must follow the rules and syntax of the map construct. The following settings for a single property serve as an example which illustrates that for applications other than the ones deployed on the root context and the context /Portal, the value of the property defaults to <i>value3</i>.</p> <pre>com.sun.identity.agents.config.example[Portal] = value1 com.sun.identity.agents.config.example[DefaultWebApp] = value2 com.sun.identity.agents.config.example = value3</pre> <p>Global Properties: Properties that are not configured for specific applications apply to all the applications on that deployment container. Such properties are called global properties.</p> <p>Serial number: Assigned automatically</p> <p>Name: Select from one of the following</p> <p>Value: Enter the appropriate value for the Name you chose.</p> <p>Note: To enable OpenSSO Agent configuration hotswap, make sure the opensso agents have the following properties in the Miscellaneous properties section of their profile in the OpenSSO Proxy on OAM Server, and the agent servers are restarted:</p> <p>J2ee Agents: <code>com.sun.identity.client.notification.url =http://<AGENT_SERVER_HOST>:<AGENT_SERVER_PORT>/agentapp/notification</code></p> <p>Web Agents:</p> <pre>com.sun.identity.client.notification.url =http:// AGENT_SERVER_HOST:AGENT_SERVER_PORT/UpdateAgentCacheServlet? shortcircuit=false</pre> <p>Not Supported, Web Agents:</p> <pre>com.sun.identity.agents.config.change.notification.enable = true</pre>
See Also:	"OpenSSO Bootstrap Configuration Mappings"

Table 28-7 (Cont.) Expanded OpenSSO Agent Registration Elements

Element	Description
Element	Description
See Also:	Table 28-5
Status	The state of this agent registration: Enabled or Disabled. Default: Enabled

Table 28-7 (Cont.) Expanded OpenSSO Agent Registration Elements

Element	Description
Filter mode <i>J2EE Agent Type only</i>	<p>The Agent filter is installed within the protected application. It facilitates the enforcement of security policies, governing the access to all resources within the protected application. Every application protected by the J2EE Agent must have its deployment descriptors changed to reflect that it is configured to use the agent filter. Applications that do not have this setting are not protected by J2EE the Agent and might malfunction or become unusable if deployed on a deployment container where the Agent realm is installed.</p> <p>Filter modes must be set for the J2EE Agent by choosing one of the following options: SSO_ONLY or URL_Policy.</p> <p>Default: URL_Policy</p> <ul style="list-style-type: none"> • SSO_ONLY (Access Manager Authentication Only): Enables the least restrictive mode of operation for the filter; the agent simply ensures that all users who try to access protected web resources are authenticated. • URL_Policy (Access Manager Authentication and Authorization): Enables the agent filter to enforce URL policies. By default, with Web Agents, <code>.com.sun.identity.agents.config.sso.onlyattribute</code> is set to "false". <p>Process overview: Authentication Only (SSO_ONLY J2EE Filter Mode)</p> <ol style="list-style-type: none"> 1. End user requests access to an application or resource protected by OpenSSO Agent. 2. OpenSSO Agent redirects this un-authenticated user to OAM Server for authentication. 3. After successful authentication, OpenSSO Proxy redirects the user back to the protected resource with OpenSSO session ID set in the response cookie. 4. Authenticated end user with valid OpenSSO session, accesses application or resource protected by OpenSSO Agent. 5. OpenSSO Agent validates the OpenSSO Session against OAM Server through the OpenSSO Proxy and enables SSO for the end user. 6. End user gets access to the protected application or resource. <p>Process overview: Authentication and Authorization with URL_Policy J2EE Filter Mode</p> <ol style="list-style-type: none"> 1. End user requests access to an application or resource protected by OpenSSO agent. 2. OpenSSO Agent redirects this un-authenticated user to OAM Server for authentication. 3. After successful authentication, OpenSSO Proxy redirects the user back to the protected resource with OpenSSO session ID set in the response cookie. 4. Authenticated end user with valid OpenSSO session, accesses application or resource protected by OpenSSO Agent. 5. OpenSSO Agent validates the OpenSSO Session against OAM Server through the OpenSSO Proxy. 6. OpenSSO Agent sends Policy requests to OAM Server through the OpenSSO Proxy to ensure the authenticated user is authorized to access the resource. 7. OpenSSO Proxy evaluates the Policies for the protected resource (using OAM Policy Engine) and sends the Policy decision to the Agent: Allow or Deny. 8. End user gets access if the Policy decision is Allow. <p>Note: The following Filter Modes are not supported: NONE, J2EE_Policy, All.</p>

Table 28-7 (Cont.) Expanded OpenSSO Agent Registration Elements

Element	Description
	See Also: " Understanding OpenSSO Agent Registration Parameters ".

28.4 Registering and Managing OpenSSO Agents Using the Console

This topic provides the following topics:

- [Registering an OpenSSO Agent using the Oracle Access Management Console](#)
- [Configuring and Managing Registered OpenSSO Agents Using the Console](#)

28.4.1 Registering an OpenSSO Agent using the Oracle Access Management Console

Users with Oracle Access Management Administrator credentials can either use Oracle-provided tools to analyze and migrate an OpenSSO environment or use the Oracle Access Management Console to manually provision OpenSSO Agents.

Registration steps are the same regardless of the OpenSSO agent type you choose: Web or J2EE. You can register an OpenSSO agent before you deploy it. Users with valid Administrator credentials can perform the following task to register an OpenSSO agent using the Oracle Access Management Console.

Note:

Only centralized configuration mode is supported for new OpenSSO Agent creation.

After agent registration, you can change the communication mode of the OAM Server if needed. Communication between the agent and server continues to work as long as the Agent uses SSO Only filter mode.

Prerequisites

Confirm that at least one OAM Server is running in the same mode as the agent to be registered. Install the Agent, as described in:

- Oracle Sun OpenSSO Enterprise Policy Agent 3.0 User's Guide for Web Agents
- Oracle Sun OpenSSO Enterprise Policy Agent 3.0 User's Guide for J2EE Agents

See Also:

["Understanding OpenSSO Agent Registration Parameters"](#)

To register an OpenSSO agent using the console

1. In the Oracle Access Management Console, click Application Security at the top of the window.
2. In the Application Security Console, select **Create OpenSSO Agent** from the **Create (+)** menu in the **Agents** section.

3. On the Create OpenSSO Agent page, enter required details (with an *) ([Table 28-5](#)).
4. Confirm that the **Auto Create Policies** box is checked (or clear the box to disable this function if you do not need a new Application Domain).
5. Click **Apply** to submit the registration (or close the page without submitting it):
6. Check the Confirmation window for the location of generated artifacts and then close the window.
7. In the navigation tree, confirm the Agent name is listed.
8. Copy OpenSSO Agent bootstrap and configuration files from the console host (AdminServer) to the Agent host Web server:

OpenSSO Properties Files From ...	Path ...
From the AdminServer (Console) host	$\$DOMAIN_HOME/output/\$Agent_Name/$ <ul style="list-style-type: none"> • OpenSSOAgentBootstrap.properties • OpenSSOAgentConfiguration.properties
To the OpenSSO Agent host Web server $\$OHS_dir/config$.	For example: $\$WebTier_MW_HOME/Oracle_WT1/instances1/config/OHS/ohs1/config/$

9. Restart the OAM Server hosting the Agent.
10. Proceed to the following topics, as needed:
 - ["Configuring and Managing Registered OpenSSO Agents Using the Console"](#)
 - [Managing Access Manager SSO, Policies, and Testing](#)

28.4.2 Configuring and Managing Registered OpenSSO Agents Using the Console

The procedure is the same whether you are editing (view, modify, or delete) a J2EE or Web type OpenSSO agent. Users with valid Administrator credentials can change any setting for a registered agent using the Oracle Access Management Console.

After changes, updated details are propagated through a runtime configuration update process. There is usually no need to copy the artifacts over to OpenSSO agent configuration area. Artifacts need only be copied to the OpenSSO agent directory path if the agent name, password, or security mode is changed.

Note:

Deleting an agent registration removes only the registration (not the associated host identifier, Application Domain, resources, or the agent instance itself), which prevents registering the same agent again if required. However, deleting the Application Domain and its content removes all referenced objects including the Agent registration, as described in ["Deleting an Application Domain and Its Contents"](#).

Prerequisites

The agent must be registered and the registration visible in the Oracle Access Management Console. The AdminServer and one OAM Server must be running.

See Also:

["The Expanded OpenSSO Agent Page and Parameters"](#)

To view or modify registration details (or delete a registration)

1. In the Oracle Access Management Console, click **Application Security** at the top of the window.
 - a. In the Application Security console, click **Agents** to display the Agents Search page.
 - b. **Find a Registration:** Fill in the form (Agent Name or Agent Type or both) or simply click the Search button.
 - c. **Open a Registration:** Click the Agent name in the results table to open the page.
2. **Modify Existing Details:**
 - a. Add or modify agent details as desired ([Table 28-5](#)).
 - b. Click **Apply** to submit changes, then dismiss the Confirmation window.
 - c. Copy OpenSSO Agent configuration files only if the Agent name, password, or security mode was changed.
3. **Delete OpenSSO Agent Registration:** This does not remove the Agent instance itself, only the registration page from the console.
 - a. Close the agent's registration page if it is open.
 - b. Click the desired agent's name, click the Delete button in the tool bar, and confirm the removal in the Confirmation window.
 - c. Confirm the Agent name is absent in the navigation tree.
4. Restart the OAM Server hosting the Agent.
5. Proceed to [Managing Access Manager SSO, Policies, and Testing](#).

28.5 Performing Remote Registration for OpenSSO Agents

This section provides a brief review of remote registration using the Oracle-provided tool: oamreg. this section provides the following topics:

- [Request Templates for OpenSSO Agent Remote Registration](#)
- [OpenSSO Bootstrap Configuration Mappings](#)
- [Performing In-Band Remote Registration with OpenSSO Agents](#)
- [Performing Out-of-Band Remote Registration with OpenSSO Agents](#)

28.5.1 Request Templates for OpenSSO Agent Remote Registration

Each OpenSSO Agent provides restricted access to applications by intercepting requests to these applications. OpenSSO Agent provisioning is the process of registering an OpenSSO agent to use Access Manager.

Both inband and outofband remote registration modes require a request file with the input argument, as listed in [Table 28-8](#)

Table 28-8 OpenSSO Request Files for Remote Registration

Templates for . . .	Description
Register OpenSSO Agents	<ul style="list-style-type: none"> • \$OAM_REG_HOME/input/OpenSSORequest.xml • \$OAM_REG_HOME/input/OpenSSORequest_short.xml <p>When you run oamreg with the short request, default values are applied automatically for elements found only in the extended request.</p>
Other Templates	
Update Agent:	\$OAM_REG_HOME/input/OpenSSOUpdateAgentRequest.xml See Also: " Updating Agents Remotely "
Create Policies: Create New Host Identifiers and an Application Domain without Registering an Agent	\$OAM_REG_HOME/input/CreatePolicyRequest.xml See Also: " Managing Policies and Application Domains Remotely "
Update Policies: Existing Host Identifiers and Application Domain (not associated with an Agent Registration)	\$OAM_REG_HOME/input/UpdatePolicyRequest.xml See Also: " Managing Policies and Application Domains Remotely "

Remote OpenSSO Agent registration automatically:

- Creates the agent page for the Oracle Access Management Console
- Creates an Application Domain and basic policies to protect applications
- Produces OpenSSO properties files on the client to be consumed by the agent at run time

[Table 28-9](#) identifies the elements in OpenSSO Agent request templates. Unless explicitly stated, all elements are found in both the short and the extended request files.

Table 28-9 OpenSSO Agent Remote Registration Request

Element	Description	Example
<serverAddress> <agentName> <hostIdentifier> <agentBaseUrl> <autoCreatePolicy> <applicationDomain> <virtualhost>	Elements common to all remote registration request templates.	See Table 15-8
<agentType>	Choose between J2EE or Web type OpenSSO agents.	<agentType> WEB </agentType>
Password Re-enter Password	<p>A required, unique password for this OpenSSO agent, which can be assigned during this registration process. The entry will appear in obfuscated format in the console, in oam-config.xml, and in OpenSSOAgentBootstrap.properties.</p> <p>When a registered agent connects to an OAM SServer, the user is prompted for the password. The password is used for authentication to prevent unauthorized agents from connecting and obtaining policy information.</p>	You are asked to supply a password during remote registration. This does not appear in the template.
Extended OpenSSO Template Only		
<agentDebugDir>	<p>With <debug> set to true, you can configure the directory path for logged agent messages.</p> <p>Default: None</p> <p>See Also: Logging Component Event Messages</p>	<agentDebugDir> scratch/debug </agentDebugDir>
<agentAuditDir>	<p>Defines the directory path for audit logs from the OAM Server:</p> <ul style="list-style-type: none"> • Audit Login events • Audit Logout success events <p>See Also: Auditing Administrative and Run-time Events</p>	<agentAuditDir> scratch/audit </agentAuditDir>
<agentAuditFileName>	Defines the audit log file name.	<agentAuditFileName> audit.log </agentAuditFileName>

Table 28-9 (Cont.) OpenSSO Agent Remote Registration Request

Element	Description	Example
<debug>	<p>When set to <code>true</code>, the OAM Server logs messages for:</p> <ul style="list-style-type: none"> • Login success and login failure events • Logout success and logout failure events • Log messages at different logging levels (FATAL, ERROR, WARNING, DEBUG, TRACE), each of which indicates severity in descending order. <p>Default: <code>false</code> See Also: Logging Component Event Messages</p>	<debug> false </debug>
<cookieName>	<p>The name of the cookie, which the agent finds this cookie after the OpenSSO Proxy triggers session validation</p> <p>The end user has the following valid cookies:</p> <ul style="list-style-type: none"> • OAM_ID cookie (represents the end user session after agent authentication) • OpenSSO cookie 	<cookieName> iPlanetDirectoryPro </cookieName>
<accessDeniedUrl>	<p>If access is denied, the user is redirected to this URL.</p>	<accessDeniedUrl></accessDeniedUrl>
<protectedAuthnScheme>	<p>Specifies the Authentication Scheme to use in the Authentication Policy.</p> <p>In an upgraded environment, use <code>SSOCoExistMigrateScheme</code> for the Protected Resource Policy for any new OSSO Agents you register.</p>	<protectedAuthnScheme></protectedAuthnScheme>

28.5.2 OpenSSO Bootstrap Configuration Mappings

This section describes the bootstrap configuration mappings of an OpenSSO Agent.

- [Table 28-10](#)
- [Table 28-11](#)

Table 28-10 J2EE Request File Mappings to the Properties File

Property Name	Default Value	Sample Value
com.ipplanet.am.naming.url	from input xml as <serverAddress>/opensso/ namingervice	http://example.com:7575/opensso/ namingervice
com.sun.identity.agents.app.username	from input xml as <agentName>	<Agent registration ID>
com.ipplanet.am.service.secret	from input xml as <agentPassword> Note: This is not collected as part of the input XML file but is prompted for by the remote registration tool.	<Encrypted Agent registration ID password>
com.ipplanet.services.debug.directory	from input xml as <agentDebugDir>	/opt/30j2ee/j2ee_agents/ tomcat_v6_agent/Agent_001/logs/ debug
com.sun.identity.agents.config.local.logfile	from input xml as <agentAuditDir>/ <agentAuditFileName>	/opt/30j2ee/j2ee_agents/ tomcat_v6_agent/Agent_001/logs/ audit/ amAgent_example_com_7676.log
com.sun.identity.agents.config.organization.name	from input xml as <realmName> Note: This is the <hostIdentifier> value collected from the input xml file. By default it is taken as the <agentName> unless explicitly provided.	
com.sun.identity.agents.config.profilename	from input xml as <agentName>	<Agent registration ID>
Not included in the remote registration file ...		
com.ipplanet.am.naming.url	N/A	N/A
com.sun.identity.agents.config.service.resolver	N/A	N/A
com.sun.services.debug.mergeall	N/A	N/A
com.sun.identity.agents.config.lock.enable	FALSE N/A	N/A
am.encryption.pwd	N/A	N/A

Table 28-11 shows the mappings between a Web Agent request file and properties file.

Table 28-11 Mapping the Web Request File to the Properties File

Property Name	Default Value	Sample Value
com.iplanet.am.naming.url	from input xml as <serverAddress>/ <serverAddress>/opensso/ namingervice	http://example.com:7575/opensso/ namingervice
com.sun.identity.agents.config.username	from input xml as <agentName>	<Agent profile ID>
com.sun.identity.agents.config.password	from input xml as <agentPassword> Note: This is not collected as part of the input XML file but is prompted for by the remote registration tool.	<Encrypted Agent registration ID password>
com.iplanet.services.debug.directory	from input xml as <agentDebugDir>	/opt/30j2ee/j2ee_agents/ tomcat_v6_agent/Agent_001/logs/ debug
com.sun.identity.agents.config.local.logfile	from input xml as <agentAuditDir>/ <agentAuditFileName>	/opt/30j2ee/j2ee_agents/ tomcat_v6_agent/Agent_001/logs/ audit/ amAgent_redsky_red_ipplanet_com _7676.log
com.sun.identity.agents.config.organization.name	from input xml as <realmName> Note: It is the <hostIdentifier> value collected from the input xml. Status: Open Fixed or Closed	
com.sun.identity.agents.config.profilename	from input xml as <agentName>	

28.5.3 Performing In-Band Remote Registration with OpenSSO Agents

Here is a brief summary of tasks required to perform in-band remote registration for your OpenSSO agent.

Prerequisites

"[OAM Remote Registration](#)"

Task overview: In-band Administrators performing remote registration

1. Acquire the registration tool and set environment variables as described in "[Acquiring and Setting Up the Remote Registration Tool](#)".

```
$ORACLE_HOME/oam/server/rreg/client/RREG.tar.gz
```

2. Create your input file with unique values for the agent and Application Domain as described in "[Creating Your Remote Registration Request](#)".

From: OpenSSORequest.xml

To: *myopenssoagent_request.xml*

3. Run the registration tool to configure the Agent, create a default Application Domain for the resources, and copy the updated agent configuration file as described in "[Performing In-Band Remote Registration](#)".

From the console host (AdminServer):

```
/rreg/output/Agent_Name/
```

- OpenSSOAgentBootstrap.properties
- OpenSSOAgentConfiguration.properties

To the OpenSSO Agent host Web server *\$OHS_dir/config*. For example:

```
$WebTier_MW_HOME/Oracle_WT1/instances1/config/OHS/ohs1/config/
```

4. Validate the configuration as described in "[Validating Remote Registration and Resource Protection](#)".
5. Perform access checks to validate that the configuration is working, as described in "[Verifying Authentication and Access After Remote Registration](#)".

28.5.4 Performing Out-of-Band Remote Registration with OpenSSO Agents

Here is a brief summary of tasks required to perform out-of-band remote registration for your OpenSSO agent.

Prerequisites

["OAM Remote Registration"](#)

Task overview: Out-of-band remote registration (Agent is outside the network)

1. **Out-of-band Administrator:** Creates a starting request input file containing specific application and agent details and submits it to the in-band Administrator.

- Acquire the registration tool and set environment variables as described in "[Acquiring and Setting Up the Remote Registration Tool](#)".

```
$ORACLE_HOME/oam/server/rreg/client/RREG.tar.gz
```

- Copy and edit a template to input unique values for the agent and Application Domain as described in "[Creating Your Remote Registration Request](#)".

```
$OAM_REG_HOME/input/OpenSSOrequest.xml
```

- Submit the starting request input file to the in-band Administrator using a method you choose (email or file transfer).

2. **In-band Administrator:**

- Acquire the registration tool and set environment variables as described in "[Acquiring and Setting Up the Remote Registration Tool](#)".

```
$ORACLE_HOME/oam/server/rreg/client/RREG.tar.gz
```

- Use the out-of-band starting request with the registration tool to register the agent and create the response and native agent configuration files to return to

the out-of-band Administrator. See "[Performing Out-of-Band Remote Registration](#)":

- `opensso_Response.xml` is generated for the out of band Administrator to use in Step 3.
 - OpenSSO properties files are modified for the out-of-band Administrator to bootstrap the OSSO module.
3. **Out-of-band Administrator:** Use the registration tool with the response file and copy artifacts to the appropriate file system directory.
 - `opensso_Response.xml`.
 - `opensso...properties` files
 4. **In-band Administrator:** Validates the configuration as described in "[Validating Remote Registration and Resource Protection](#)".
 5. **Out-of-band Administrator:** Performs several access checks to validate that the configuration is working, as described in "[Verifying Authentication and Access After Remote Registration](#)".

28.6 Open SSO Remote Registration versus Remote Updates

The update request file passes specific values to the remote registration tool, `oamreg`. The primary differences between the update template and the original registration template is that the update template.

Table 28-12 Delta: OpenSSO Remote Registration versus Remote Updates

Delta	Element
Adds	<code><startDate>yyyy_mm_dd</startDate></code> element to track changes
Adds	<code><homeUrl></code> element that specifies the <code>agent_base_url_port</code>
Omits	<code><hostidentifier></code>
Omits	<code><agentbaseURL></code>

See Also:

- [Table 28-7](#)
 - [Updating OpenSSO Agents Remotely](#)
-

28.6.1 Updating OpenSSO Agents Remotely

You can update, validate, and delete OSSO Agents using remote registration templates and modes.

For more information, see "[Remote Agent Update Modes and Templates](#)".

To remotely update OAM 10g Agent registration

1. Set up the registration tool as described in, "[Acquiring and Setting Up the Remote Registration Tool](#)".

2. **Update Agent:**

- a. Create your update request using the `OAMUpdateAgentRequest.xml` template.
- b. On the computer hosting the Agent, run the following command with `agentUpdate` mode specify your own `*Request*.xml` as the input file. For example:

```
./bin/oamreg.sh agentUpdate input/OpenSSOUpdateAgentRequest.xml
```

- c. Provide the registration Administrator user name and password when asked.
- d. Confirm success with on-screen messages.
- e. Relocate to the agent host `OpenSSOAgentBootstrap` and `OpenSSOAgentConfiguration.properties` files:

From the AdminServer (Console) host: `/rreg/output/Agent_Name/`

To the OpenSSO Agent host Web server `$OHS_dir/config`. For example:

```
$WebTier_MW_HOME/Oracle_WT1/instances1/config/OHS/ohs1/
config/*.properties
```

- f. Restart the OAM Server that is hosting this agent

3. **Validating Agent:**

- a. On the Agent host, run the following command in `agentValidate` mode. For example:

```
./bin/oamreg.sh agentValidate agentname
```

- b. Provide the registration Administrator user name and password when asked.
- c. Confirm success with on-screen messages.

4. **Deleting an Agent:**

- a. On the computer hosting the Agent, run the following `agentDelete` command. For example:

```
./bin/oamreg.sh agentDelete agentname
```

- b. Provide the registration Administrator user name and password when asked.
- c. Confirm success with on-screen messages.

Success: On-screen message confirms

```
AgentDelete process completed successfully!
```

28.7 Other OpenSSO Agent Information in this Guide

See [Table 28-13](#) for additional information on legacy OpenSSO agents with Access Manager.

Table 28-13 Other OpenSSO Information in this Guide

Topic	Location
Component Loggers	Table 7-3
OpenSSO Metrics in the DMS Console	"Monitoring OpenSSO Proxy Metrics"
Sessions and Session Management	Maintaining Access Manager Sessions
Artifacts	"Generated Artifacts: OpenSSO" "Migrated Artifacts: OpenSSO"

Registering and Managing Legacy OSSO Agents

If legacy OracleAS SSO 10g is already in place as the enterprise solution for an existing deployment, Oracle Fusion Middleware continues to support this as a solution. Additionally, you can register existing OSSO 10g `mod_osso` modules as agents for Access Manager as described in [Introduction to Agents and Registration](#)

The following topics explain how to register or manage legacy OSSO agents with Access Manager 11.1.2:

- [Understanding OSSO Agents with Access Manager](#)
- [Registering OSSO Agents Using Oracle Access Management Console](#)
- [Configuring and Managing Registered OSSO Agents Using the Console](#)
- [Performing Remote Registration for OSSO Agents](#)
- [Updating Registered OSSO Agents Remotely](#)
- [Configuring Logout for OSSO Agents with Access Manager 11.1.2](#)
- [Locating Other OSSO Agent Information](#)

29.1 Understanding OSSO Agents with Access Manager

The following topics provide information about:

- [About OSSO Agents with Access Manager](#)
- [Comparing Access Manager 11g SSO versus OSSO 10g](#)

29.1.1 About OSSO Agents with Access Manager

The `mod_osso` module is an Oracle HTTP Server module that simplifies the authentication process by serving as the sole application to the single sign-on server. In this way, `mod_osso` renders authentication transparent to OracleAS applications. It enables applications protected by OracleAS Single Sign-On to accept HTTP headers in lieu of a user name and password once the user has logged in. The values for these headers are stored in a `mod_osso` cookie.

The Administrator for these applications is spared the burden of integrating them with an SDK. After authenticating a user, `mod_osso` transmits the simple header values that applications may use to authorize the user:

- User name
- User GUID (global user identity)

- Language and territory

After registration with Access Manager, OSSO 10g Agents can communicate directly with Access Manager 11g services through the OSSO proxy. The OSSO proxy supports existing OSSO agents when upgrading to Access Manager. The proxy handles requests from OSSO Agents and translates the OSSO protocol into a protocol for Access Manager 11g authentication services.

The OSSO Proxy supports inter-operability between Access Manager and OSSO agents (using an OSSO agent to access a valid SSO session created for a Webgate or Access Client and vice versa).

OSSO Proxy Supports	Description
SSO login	From an OSSO Agent to the OAM Server (and OSSO-specific tokens)
SSO logout	From the OSSO Agent to the OAM Server
OSSO Agent requests and protocols	OSSO Proxy translates the OSSO protocol into a protocol for Access Manager.

After registering 10g mod_osso as an agent, Access Manager gives mod_osso the redirect URL for the user based on the authentication scheme associated with the OAM policy defined for the resource ([Table 29-1](#)).

Table 29-1 OSSO Agents with Access Manager

OSSO Agents	Access Manager
Checks for an existing valid Oracle HTTP Server cookie	Redirects to the OAM Server if needed to contact the directory during authentication
Decrypts the encrypted user identity populated by the OSSO server	Sets the headers with user attributes

29.1.2 Comparing Access Manager 11g SSO versus OSSO 10g

This topic introduces key components for implementing and enforcing Access Manager 11g single sign-on policies as compared to OSSO 10g. Access Manager 11g default behavior is to deny access when a resource is not protected by a policy that explicitly allows access. OracleAS SSO 10g provides only authentication.

[Table 29-2](#) summarizes the differences.

Table 29-2 11g Access Manager SSO versus OSSO 10g Component Summary

Component Description	11g Access Manager	OSSO 10g
Oracle Identity Management Infrastructure	Enables secure, central management of enterprise identities.	Enables secure, central management of enterprise identities.
Agents Resides with the relying parties and delegate authentication and authorization tasks to OAM Servers.	<ul style="list-style-type: none"> • 11g OAM Agents • 10g OAM Agents • 10g OSSO Agents (mod_osso) • OpenSSO Agents <p>Note: Nine Administrator languages are supported.</p>	<ul style="list-style-type: none"> • mod_osso (partner) <p>Note: The mod_osso module is an Oracle HTTP Server module that provides authentication to OracleAS applications.</p>

Table 29-2 (Cont.) 11g Access Manager SSO versus OSSO 10g Component Summary

Component Description	11g Access Manager	OSSO 10g
<p>Servers</p> <p>Notes: Administrative users access the console home page by typing the URL: <code>https://host:port/oamconsole</code>.</p> <p>Non-administrative users first gain access to the single sign-on server by entering the URL of an application, which returns the SSO login page.</p>	<ul style="list-style-type: none"> OAM Server Oracle Access Management Console (installed on the WebLogic Administration Server) <p>See Also: "Understanding the Oracle Access Management Console " "Understanding Credential Collection and Login "</p>	<ul style="list-style-type: none"> OracleAS SSO server (OSSO server) <p>See Also: .</p>
<p>Proxy</p> <p>Provides support for legacy systems:</p>	<ul style="list-style-type: none"> OAM Proxy supports legacy Access Manager implementations by acting as a legacy Access Server. OSSO Proxy supports OSSO Agents by acting as the legacy OSSO Server. Oracle-provided OpenSSO Proxy handles requests for resources protected by OpenSSO Agents 	<ul style="list-style-type: none"> OSSO Proxy supports legacy SSO implementations by acting as the legacy OSSO Server.
Console	Oracle Access Management Console	No console equivalent before Access Manager 11g.
Protocols that secure information exchange on the Internet	<p>Front channel protocols exchanged between Agent and Server: HTTP/HTTPS.</p> <p>11g Webgate secures information exchange using the Agent key.</p> <p>-See Also: Cryptographic keys.</p>	N/A
Policy Store	Database	mod_osso and partner application
Applications	<p>An application that delegates authentication and authorization to Access Manager and accepts headers from a registered Agent.</p> <p>Note: External applications do not delegate authentication. Instead, these display HTML login forms that ask for application user names and passwords. For example, Yahoo! Mail is an external application that uses HTML login forms.</p>	<p>An application that delegates authentication to mod_osso and the OracleAS Single Sign-On server.</p> <p>Note: After registering mod_osso with Access Manager 11g, mod_osso delegates authentication to OAM.</p> <p>The mod_osso module enables the applications to accept authenticated user information once the user is logged in. Re authenticating is avoided by accepting headers from the registered OSSO Agent.</p> <p>The application is responsible for determining whether the authenticated user is authorized to use the application.</p>

Table 29-2 (Cont.) 11g Access Manager SSO versus OSSO 10g Component Summary

Component Description	11g Access Manager	OSSO 10g
SSO Engine	<p>Manages the session lifecycle, facilitates global logout across all relying parties in the valid session, and provides consistent service across multiple protocols.</p> <p>Uses Agents registered with Access Manager 11g:</p> <ul style="list-style-type: none"> • Authentication (credential collection) occurs across the HTTP (HTTPS) channel • Authorization occurs across the Oracle Access Protocol (OAP) channel 	<ul style="list-style-type: none"> • mod_osso delegates authentication only and communicates exclusively through the HTTP channel.
Cryptographic keys	<ul style="list-style-type: none"> • During 11g agent registration, a key is generated for the agent and also shared with the OAM Server • The key is used for encrypting and decrypting SSO cookies • During 10g agent registration, a global shared secret key is generated across all of Access Manager 11g (all Agents and OAM Servers). • During OSSO agent registration, One key per partner shared between mod_osso and OSSO server. • OpenSSO Agent: Host- or Domain-based key stored locally in bootstrap file on Agent host. • During OAM Server installation, one OAM Server key is generated <p>Note: One key is generated and used per registered mod_osso Agent. However, one single key is generated for all 10g Webgates.</p>	<ul style="list-style-type: none"> • One key per partner shared between mod_osso and OSSO server • OSSO server's own key • One global key per OSSO setup for the GITO domain cookie
Keys storage	<ul style="list-style-type: none"> • Agent side: A per-agent key is stored locally in the Oracle Secret Store in a wallet file • OAM Server side: A per-agent key, and server key, are stored in the credential store on the server side • Security Token Service 	<ul style="list-style-type: none"> • mod_osso side: partner keys and GITO global key stored locally in obfuscated configuration file • OSSO server side: partner keys, GITO global key, and server key are all stored in the directory server

Table 29-2 (Cont.) 11g Access Manager SSO versus OSSO 10g Component Summary

Component Description	11g Access Manager	OSSO 10g
Cookies See Also: Table 21-6 and "Single Sign-On Cookies During User Login"	Host-based authentication cookie: <ul style="list-style-type: none"> • 11g Webgate, One per agent: OAMAuthnCookie_<host:port>_<random number> • 10g Webgate, One ObSSOCookie for all 10g Webgates. • One for the OAM Server: OAM_ID (Table 21-6) 	<ul style="list-style-type: none"> • Host-based authentication cookie: <ul style="list-style-type: none"> one per partner: OHS-<i>host-port</i> one for OSSO server: (not with Access Manager 11g) • Domain-level session cookie for global inactivity timeout (GITO) if enabled
Policies	Registered agents rely on Access Manager authentication, authorization, and token issuance policies to determine who gets access to protected applications (defined resources).	mod_osso uses only Access Manager 11g authentication policies to determine who gets access to defined resources. mod_osso provides authentication only.
Client IP	<ul style="list-style-type: none"> • Maintain this Client IP, and include it in the host-based OAMAuthnCookie. 	<ul style="list-style-type: none"> • Include the original client IP inside the host cookie. In later authentication requests, when the cookie is presented, the original client IP is compared with the presenter's IP. Rejection occurs if there is no match

Table 29-2 (Cont.) 11g Access Manager SSO versus OSSO 10g Component Summary

Component Description	11g Access Manager	OSSO 10g
Encryption / Decryption (converting encrypted data back into original form)	<p data-bbox="574 321 959 432">Introduces client-side cryptography and ensures that cryptography is performed at both the agent and server ends:</p> <ol data-bbox="574 464 959 1377" style="list-style-type: none"> <li data-bbox="574 464 959 667">1. Webgate encrypts obrareq.cgi using the agent key. Note: obrareq.cgi is the authentication request in the form of a query string redirected from Webgate to OAM Server. <li data-bbox="574 699 959 810">2. OAM Server decrypts the request, authenticates, creates the session, and sets the server cookie. <li data-bbox="574 842 959 1119">3. OAM Server also generates the authentication token for the agent (encrypted using the agent key), packs it in obrar.cgi with a session token (if using cookie-based session management), authentication token and other parameters, then encrypts obrar.cgi using the agent key. Note: obrar.cgi is the authentication response string redirected from the OAM Server to Webgate. <li data-bbox="574 1272 959 1377">4. Webgate decrypts obrar.cgi, extracts the authentication token, and sets a host-based cookie. 	<p data-bbox="984 321 1369 380">Cryptography is performed at both mod_osso and OSSO server:</p> <ol data-bbox="984 411 1369 936" style="list-style-type: none"> <li data-bbox="984 411 1369 527">1. site2pstore token (request from mod_osso to server) is encrypted using the partner key locally at mod_osso. <li data-bbox="984 548 1369 663">2. OSSO server decrypts site2pstore token, authenticates, and generates its own cookie. <li data-bbox="984 684 1369 800">3. urlc token (the response from OSSO server to mod_osso) is encrypted using the partner key at the server. <li data-bbox="984 821 1369 936">4. mod_osso decrypts the urlc token locally and re-encrypts using its own format to set in a host-based cookie.
Session Management	<ul data-bbox="574 1419 943 1535" style="list-style-type: none"> <li data-bbox="574 1419 943 1535">• Session idle timeout behavior is supported through the 11g Session Management Engine (SME). 	<ul data-bbox="984 1419 1369 1797" style="list-style-type: none"> <li data-bbox="984 1419 1369 1535">• Single domain supported through a domain-level cookie for global inactivity timeout (GITO). Multi-domain SSO: After a user logs in to one domain, and then goes to a different domain, he is considered idle from the first domain. When the idle times out on the original domain, the user must re-authenticate on the original domain.

Table 29-2 (Cont.) 11g Access Manager SSO versus OSSO 10g Component Summary

Component Description	11g Access Manager	OSSO 10g
Response token replay prevention	<ul style="list-style-type: none"> Include RequestTime (the timestamp just before redirect) in obrareq.cgi and copy it to obrar.cgi to prevent response token replay. 	<ul style="list-style-type: none"> Include RequestTime (timestamp just before redirect) in the site2pstore token and copy it to the urlc token to prevent token replay.
Multiple network domain support	Access Manager 11g supports cross-network-domain single sign-on out of the box. Oracle recommends you use Oracle Federation for this situation.	N/A
Centralized log-out	<ul style="list-style-type: none"> The logOutUrls (10g Webgate configuration parameter) is preserved. 10g logout.html requires specific details for Access Manager 11g. 11g Webgate parameters are new: Logout Redirect URL Logout Callback URL Logout Target URL See Configuring Centralized Logout for Sessions Involving 11g WebGates .	There is no change required for Access Manager 11g with mod_osso (OSSO Agents). Applications that use dynamic directives require no entry in mod_osso.conf. Instead, protection is written into the application as one or more dynamic directives. See Configuring Centralized Logout for Sessions Involving 11g WebGates .

See Also:

["Understanding Credential Collection and Login "](#)

29.2 Registering OSSO Agents Using Oracle Access Management Console

You can manage OSSO Agent registrations (mod_osso) using the Oracle Access Management Console.

See:

- [Understanding the Create OSSO Agent Registration Page and Parameters](#)
- [Registering an OSSO Agent \(mod_osso\) Using the Console](#)

29.2.1 Understanding the Create OSSO Agent Registration Page and Parameters

OSSO Agent registration use the Oracle Access Management Console.

Note:

Before you register an OSSO Agent, ensure that the Oracle HTTP Server is installed on the client computer and that the Web server is configured for mod_osso.

Table 29-3 shows a Create OSSO Agent page, under the System Configuration tab in the Oracle Access Management Console.

Figure 29-1 Create OSSO Agent Page

On the Create OSSO Agent page, required information is identified by the asterisk (*). Table 29-3 describes the required and optional details that you can specify when you register a new agent.

Table 29-3 Create OSSO Agent Page Elements

Element	Description
Name	The identifying name for this mod_osso Agent.
Token Version	The default version of the token is 3.0; the following options are available: <ul style="list-style-type: none"> • 1.2 • 1.4 • 3.0
Base URL Required for OSSO agents.	The required protocol, host, and port of the computer on which the Web server for the agent is installed. For example, <code>http://host.example.domain.com:port</code> or <code>https://example.domain.com:port</code> . Note: The host and port are used as defaults for the expanded registration. See Table 29-5.
Admin ID	Optional Administrator log in ID for this mod_osso instance. For example, <i>SiteAdmin</i> .
Admin Info	Optional Administrator details for this mod_osso instance. For example, <i>Application Administrator</i> .
Host Identifier	The host identifier is filled in automatically based on the Agent name.
Auto Create Policies	During agent registration, you can have authentication and authorization policies created automatically. This option is checked (enabled) by default. The OSSO Proxy requires an Application Domain that includes a resource with the generic URL (<code>/**</code>) protected by a policy based on the LDAP scheme (default). This is why a generic URL is used at the server side. Default: Enabled Notes: If you already have a domain and policies registered, you can simply add new resources to it. If you clear (uncheck) this option, no Application Domain or policies are generated automatically. In an upgraded deployment, you must change the Authentication Scheme in your Authentication Policy to use <code>SSOCoExistMigrateScheme</code> .

To help streamline Agent registration, several elements are concealed and default values are used during registration with the console. When you view an agent's

registration page in the Oracle Access Management Console, all elements and values appear.

See "[About the Expanded OSSO Agent Page in the Console](#)".

29.2.1.1 About the OSSO Agent Configuration File

The OSSO Agent configuration file, `osso.conf`, is updated during agent registration and configuration changes. It is stored on the console host (AdminServer).

Following registration or configuration updates, you must relocate the artifacts to the `mod_osso` directory path on the Agent host as shown in [Table 29-4](#).

Table 29-4 Relocating OSSO Artifacts

From AdminServer . . .	To OHS_dir/osso.conf
<code>\$DOMAIN_HOME/output/\$Agent_Name/</code>	<code>\$WebTier_MW_HOME/Oracle_WT1/instances1/config/OHS/ohs1/config/osso</code>

29.2.2 Registering an OSSO Agent (mod_osso) Using the Console

Users with Oracle Access Management Administrator credentials can register an OSSO Agent using the Oracle Access Management Console.

You must meet the following prerequisites for the registration of an OSSO agent:

The Oracle HTTP Server must be installed and run on the client computer, and must also be configured for `mod_osso`.

See Also:

[Understanding the Create OSSO Agent Registration Page and Parameters](#)

To register an OSSO Agent:

1. In the Oracle Access Management Console, click **Application Security** at the top of the window.
2. In the Application Security console, select **Create OSSO Agent** from the **Create (+)** drop-down list in the Agents section.
3. On the Create OSSO Agent page, enter required details, as shown in [Table 29-3](#):
 - Name
 - Base URL
4. Select the desired Token Version, and enter optional details.
See ([Table 29-3](#)).
5. Click **Apply** to submit the registration (or close the page without applying changes).

- In the Confirmation window, check the path to generated artifacts and then close the window.

For example:

Artifacts are generated in following location : `/.../base_domain/output/
$Agent_Name`

- Copy the `osso.conf` file from the console host (AdminServer) to the Agent host Web server. For example:

osso.conf From ...	Path ...
From the AdminServer (Console) host	<code>\$DOMAIN_HOME/output/\$Agent_Name/</code>
To the <code>mod_osso</code> directory path on the Agent host Web server: <code>\$OHS_dir/osso.conf</code> .	<code>\$WebTier_MW_HOME/Oracle_WT1/instances1/config/OHS/ohs1/config/osso.conf</code>

- In an upgraded deployment, change the Authentication Scheme in the Protected Resources Policy to use `SSOCoExistMigrateScheme`.
- Restart the OAM Server hosting the Agent.
- Proceed as needed:
 - ["Configuring and Managing Registered OSSO Agents Using the Console"](#)
 - [Managing Access Manager SSO, Policies, and Testing](#)

29.3 Configuring and Managing Registered OSSO Agents Using the Console

You can manage OSSO Agent registrations (`mod_osso`) using the Oracle Access Management Console.

See:

- [About the Expanded OSSO Agent Page in the Console](#)
- [Searching for an OSSO Agent \(`mod_osso`\) Registration](#)
- [Viewing or Editing OSSO Agent \(`mod_osso`\) Registration](#)
- [Deleting an OSSO Agent \(`mod_osso`\) Registration](#)

29.3.1 About the Expanded OSSO Agent Page in the Console

During registration, only a subset of available parameters is displayed to streamline the registration process. Whether you registered the agent using the Oracle Access Management Console or the remote registration utility, you can view the full agent configuration page in the console after registration. Default values populate previously concealed elements, which are visible when you open the Agent's page.

For more information, see [Figure 29-2](#). The Confirmation window still appears.

Figure 29-2 OSSO Agent Page and Confirmation Window

MyOSSO-1 OSSO Agent Apply

Use the following screen to register an OSSO Agent. Before you register, ensure that the Oracle HTTP Server is installed on the client and that the Web server is configured for mod_osso.

Name MyOSSO-1 Admin Id

Token Version v3.0 Admin Info

Other Properties

Site Token 96ABFAA9D0E21F5B Start Date 1/5/2015

* Success URL * Home URL

* Failure URL * Logout URL

[Table 29-5](#) summarizes the expanded elements and defaults that are used by the OSSO Agent.

Table 29-5 Expanded OSSO Agent Elements

Element	Description
Site Token	The Application Token used by the partner when requesting authentication. This cannot be edited.
Success URL	The redirect URL to be used upon successful authentication. By default, osso_login_success on the fully qualified host and port specified with the Base URL are used. For example: Default: <code>https://example.domain.com:7001/osso_login_success</code>
Failure URL	The redirect URL to be used if authentication fails. By default, osso_login_failure on the fully qualified host and port specified with the Agent Base URL are used: Default: <code>https://example.domain.com:7001/osso_login_failure</code>
Start Date	First month, day, and year for which log in to the application is allowed by the server. Default: The date the Agent was registered.
Home URL	The redirect URL to be used for the Home page after authentication. By default, the fully qualified host and port specified with the Agent Base URL are used: Default: <code>https://example.domain.com:7001</code>
Logout URL	The redirect URL to be used when logging out. This redirects the user to the global logout page on the server: osso_logout_success. By default, the fully qualified host and port specified with the Agent Base URL are used: Default: <code>https://example.domain.com:7001/osso_logout_success</code> See Also: " Introduction to Centralized Logout for Access Manager 11g ".

29.3.2 Searching for an OSSO Agent (mod_osso) Registration

When you first open the OSSO Agents node, the Search form appears. The Results table lists all OSSO Agents. If there are too many to quickly locate the one that you want, you can use the controls to refine your search.

There are only two elements that you can apply to refine an OSSO Agent search: The Agent Name that is assigned during the registration or the Agent ID that is assigned by the system. You cannot search for an OSSO Agent registration unless the OSSO Agent is registered to be available in the Oracle Access Management Console.

To search for an OSSO Agent registration:

1. In the Oracle Access Management Console, click **Application Security** at the top of the window.
2. In the Application Security console, click **Agents**.
3. In the Name field, enter criteria for your search (with or without including the wild card (*)).

For example:

*my**

4. Click the **Search** button.
5. In the Search Results table:
 - **Create:** Click the Create OSSO Agent button at the top of the Search page.
 - **Edit or View:** Click the Edit command button in the tool bar to display the configuration page.
 - **Delete:** Proceed to "[Deleting an OSSO Agent \(mod_osso\) Registration](#)".
 - **Detach:** Click Detach in the tool bar to expand the table to a full page.
 - **Reconfigure Table:** Select a View menu item to alter the appearance of the results table.
6. **Apply** any changes (or dismiss the page) when finished.

29.3.3 Viewing or Editing OSSO Agent (mod_osso) Registration

Users with valid Administrator credentials can change any setting for a registered OSSO Agent in the Oracle Access Management Console.

For example, you may want to revise the end date or add Administrator information.

Prerequisites

Before you can view or edit an OSSO Agent, the Oracle HTTP Server must have been installed and already run on the client computer, and be configured for mod_osso.

See Also:

- [About the Expanded OSSO Agent Page in the Console](#)
-
-

To view or modify an OSSO Agent registration:

1. **Find the Agent:** See "[Searching for an OSSO Agent \(mod_osso\) Registration](#)".
2. **View or Modify:** On the registration page, view or modify details as needed.
See ([Table 29-3](#) and [Table 29-5](#)).
3. Click **Apply** to submit the changes (or close the page without applying changes), and close the Confirmation window.

4. Copy the `osso.conf` file from the console host (AdminServer) to the Agent host Web server. For example:

<code>osso.conf</code> From ...	Path ...
From the AdminServer (Console) host	<code>\$DOMAIN_HOME/output/\$Agent_Name/</code>
To the <code>mod_osso</code> directory path on the Agent host Web server: <code>\$OHS_dir/osso.conf</code> .	<code>\$WebTier_MW_HOME/Oracle_WT1/instances1/config/OHS/ohs1/config/osso.conf</code>

5. Restart the OAM Server hosting the Agent.
6. Proceed to [Managing Access Manager SSO, Policies, and Testing](#).

29.3.4 Deleting an OSSO Agent (`mod_osso`) Registration

Users with valid Administrator credentials can delete a registered OSSO Agent from the Oracle Access Management Console.

Note:

Deleting an agent registration removes only the registration (not the associated host identifier, Application Domain, resources, or the agent instance itself), which prevents registering the same agent again if required. However, deleting the Application Domain and its content removes all referenced objects including the Agent registration, as described in "[Deleting an Application Domain and Its Contents](#)".

Before you can delete an OSSO Agent registration, you must evaluate the Application Domain, resources, and policies associated with this agent to ensure that they are configured to use another agent or that they can be removed.

See Also:

[Searching for an OSSO Agent \(`mod_osso`\) Registration](#)

To delete an OSSO Agent registration:

1. **Find the Agent:** See "[Searching for an OSSO Agent \(`mod_osso`\) Registration](#)".
2. In the list of search results, select the desired agent and click **Delete** in the toolbar; confirm the deletion when prompted.

29.4 Performing Remote Registration for OSSO Agents

Here is a brief review of remote registration using the Oracle-provided tool (`oamreg`) with OSSO Agents.

- [About Request Templates for OSSO Remote Registration](#)
- [Performing In-Band Remote Registration of OSSO Agents](#)

- [Performing Out-of-Band Remote Registration for OSSO Agents](#)

29.4.1 About Request Templates for OSSO Remote Registration

This topic provides the OSSO Registration Request for use with the remote registration tool `oamreg.sh` (Linux) or `oamreg.bat` (Windows).

The information highlighted in bold must be modified for a `mod_osso` agent. However, all other fields can use the default values.

Both `inband` and `outofband` remote registration modes require a request file with the input argument, as listed in [Table 29-6](#).

Table 29-6 OpenSSO Request Files for Remote Registration

Templates for . . .	Description
Register OSSO Agents (<code>mod_osso</code>)	<code>\$OAM_REG_HOME/input/OSSORequest.xml</code>
Other Templates	
Update Agent:	<code>\$OAM_REG_HOME/input/OSSOUpdateAgentRequest.xml</code> See Also: " Updating Agents Remotely "
Create Policies: Create New Host Identifiers and an Application Domain without Registering an Agent	<code>\$OAM_REG_HOME/input/CreatePolicyRequest.xml</code> See Also: " Managing Policies and Application Domains Remotely "
Update Policies: Existing Host Identifiers and Application Domain (not associated with an Agent Registration)	<code>\$OAM_REG_HOME/input/UpdatePolicyRequest.xml</code> See Also: " Managing Policies and Application Domains Remotely "

[Table 29-7](#) describes elements in the OSSO request file: `OSSORequest.xml`.

Table 29-7 OSSO-Specific Elements in a Remote Registration Request

Elements	Description	Example
<code><serverAddress></code> <code><agentName></code> <code><hostIdentifier></code> <code><agentBaseUrl></code> <code><autoCreatePolicy</code> <code>></code> <code><applicationDoma</code> <code>in></code> <code><virtualhost></code>	Elements common to all remote registration request templates.	See Table 15-8

Table 29-7 (Cont.) OSSO-Specific Elements in a Remote Registration Request

Elements	Description	Example
<ssoServerVersion> >	SSO Token version values: <ul style="list-style-type: none"> v3.0: Most secure token using AES encryption standard for encrypting tokens exchanged between OAM Server and mod_osso. This is the default value. This was supported by OSSO 10.1.4.3 patch set. v1.4: This is supported by OSSO 10g prior to OSSO 10.1.4.3 patch set. Uses DES encryption standard. v1.2: This used to be version of tokens exchanged between OSSO partners prior to OSSO 10.1.4.0.1. Uses DES. 	<ssoServerVersion> >...</ssoServerVersion> >
<OracleHomePath> >	The absolute file system directory path to the mod_osso agent.	<oracleHomePath> \$ORACLE_HOME </oracleHomePath>
<updateMode>	Default: None specified	<updateMode></updateMode>
<adminInfo>	Optional. Administrator details for this mod_osso instance. For example, <i>Application Administrator</i> . Default: None specified	<adminInfo></adminInfo>
<adminId>	Optional. Administrator log in ID for this mod_osso instance. For example, <i>SiteAdmin</i> . Default: None specified	<adminId></adminId>
<logoutUrl>	Include the Logout URLs for consumption during remote registration. Default: None specified	<logoutUrl>logout1.html</logoutUrl>
<failureUrl>	Include the Failure URLs for consumption during remote registration. Default: None specified	<failureUrl>failure1.html</failureUrl>

Remote OSSO Agent registration automatically:

- Creates the agent page for the Oracle Access Management Console
- Creates an Application Domain and basic policies to protect applications
- Updates the OSSO configuration file on the client to be consumed by the agent at run time

29.4.2 Performing In-Band Remote Registration of OSSO Agents

Here is a brief summary of tasks required to perform in-band remote registration for your OSSO agent.

Full details are provided in [Registering and Managing OAM 11g Agents](#) .

You must have familiarized yourself with [OAM Remote Registration](#) before you proceed.

To perform in-band remote registration of OSSO Agents:

1. Acquire the registration tool and set environment variables.

See "[Acquiring and Setting Up the Remote Registration Tool](#) ".

```
$ORACLE_HOME/oam/server/rreg/client/RREG.tar.gz
```

2. Create your input file with unique values for the agent and Application Domain.

See "[Creating Your Remote Registration Request](#)".

```
From: OSSORequest.xml
```

```
To: myossoagent_request.xml
```

3. Run the registration tool to configure the Agent, create a default Application Domain for the resources, and copy the updated agent configuration file as described in "[Performing In-Band Remote Registration](#) ".

From AdminServer (Console) host:

```
$DOMAIN_HOME/output/$Agent_Name/osso.conf
```

To: mod_osso directory path on the Agent host: `$OHS_dir/osso.conf`. For example:

```
$WebTier_MW_HOME/Oracle_WT1/instances1/config/OHS/ohs1/config/
osso.conf
```

4. Validate the configuration as described in "[Validating Remote Registration and Resource Protection](#)".
5. Perform access checks to validate that the configuration is working.

See "[Verifying Authentication and Access After Remote Registration](#) ".

29.4.3 Performing Out-of-Band Remote Registration for OSSO Agents

The term *out-of-band registration* refers to manual registration that involves coordination and actions by both the in-band Administrator and the out-of-band Administrator.

In `outofband` mode, the in-band Administrator uses the starting request file submitted by the out-of-band Administrator, and returns a generated response file to the out-of-band Administrator for additional processing. The out-of-band Administrator runs the remote registration tool with the response file as input to update the agent configuration file.

This is a brief summary of tasks required to perform out-of-band remote registration for your OSSO agent. Full details are provided in other topics.

You must have familiarized yourself with the "[OAM Remote Registration](#)" before you can proceed.

To perform an out-of-band remote registration for out-of-network OSSO Agents:

1. **Out-of-band Administrator:** Creates a starting request input file containing specific application and agent details and submits it to the in-band Administrator.

- Acquire the registration tool and set environment variables.
See "[Acquiring and Setting Up the Remote Registration Tool](#)".

```
$ORACLE_HOME/oam/server/rreg/client/RREG.tar.gz
```

- Copy and edit a template to input unique values for the agent and Application Domain as described in "[Creating Your Remote Registration Request](#)".

```
$OAM_REG_HOME/input/OSSORequest.xml
```

- Submit the starting request input file to the in-band Administrator using a method you choose (email or file transfer).

2. In-band Administrator:

- Acquire the registration tool and set environment variables.
See "[Acquiring and Setting Up the Remote Registration Tool](#)".

```
$ORACLE_HOME/oam/server/rreg/client/RREG.tar.gz
```

- Use the out-of-band starting request with the registration tool to register the agent and create the response and native agent configuration files to return to the out-of-band Administrator.

See "[Performing Out-of-Band Remote Registration](#)":

- *osso_Response.xml* is generated for the out of band Administrator to use in Step 3.
- *osso.conf* is modified for the out-of-band Administrator to bootstrap the OSSO module.

3. Out-of-band Administrator: Use the registration tool with the response file and copy artifacts to the appropriate file system directory.

- *osso_Response.xml*.
- *osso.conf*

4. In-band Administrator: Validates the configuration as described in "[Validating Remote Registration and Resource Protection](#)".

5. Out-of-band Administrator: Performs several access checks to validate that the configuration is working.

See "[Verifying Authentication and Access After Remote Registration](#)".

29.5 Updating Registered OSSO Agents Remotely

You can update, validate, and delete OSSO Agents using remote registration templates and modes.

See "[Remote Agent Update Modes and Templates](#)".

The update request file passes specific values to the remote registration tool, `oamreg`. The primary differences between the update template and the original registration template is that the update template.

Table 29-8 Delta: OSSO Remote Registration versus Remote Updates

Delta	Element
Adds	<startDate>yyyy_mm_dd</startDate> element to track changes <homeUrl> element that specifies the agent_base_url_port
Omits	<hostidentifier>
Omits	<agentbaseURL>

To remotely update OSSO Agent registration:

1. Set up the registration tool.
See "[Acquiring and Setting Up the Remote Registration Tool](#)".
2. **Update Agent:**
 - a. Create your update request using the `OSSOUpdateAgentRequest.xml` template.
 - b. On the computer hosting the Agent, run the following command with `agentUpdate` mode specify your own `*Request*.xml` as the input file. For example:

```
./bin/oamreg.sh agentUpdate input/*OSSOUpdateAgentRequest.xml
```
 - c. Provide the registration Administrator user name and password when asked.
 - d. Confirm success with on-screen messages.
 - e. Relocate to the agent host `osso.conf`:
From the AdminServer (Console) host: `/rreg/output/Agent_Name/`
To the `mod_osso` directory path (Agent host Web server `$OHS_dir/` `osso.conf`):

```
$WebTier_MW_HOME/Oracle_WT1/instances1/config/OHS/ohs1/
config/osso.conf
```
 - f. Restart the OAM Server that is hosting this agent
3. **Validating Agent:**
 - a. On the Agent host, run the following command in `agentValidate` mode. For example:

```
./bin/oamreg.sh agentValidate agentname
```
 - b. Provide the registration Administrator user name and password when asked.
 - c. Confirm success with on-screen messages.
4. **Deleting an Agent:**
 - a. On the computer hosting the Agent, run the following `agentDelete` command. For example:

```
./bin/oamreg.sh agentDelete agentname
```

- b. Provide the registration Administrator user name and password when asked.
- c. Confirm success with on-screen messages.

Success: On-screen message confirms

AgentDelete process completed successfully!

29.6 Configuring Logout for OSSO Agents with Access Manager 11.1.2

You can configure logout for OSSO Agents with Access Manager 11.1.2.

- [About Centralized Logout with OSSO Agents \(mod_OSSO\) and Access Manager](#)
- [Removing Custom mod_osso Cookies on Logout](#)

29.6.1 About Centralized Logout with OSSO Agents (mod_OSSO) and Access Manager

With OSSO Agents (mod_osso 10g), partner applications also cede logout control to the OAM Server (single sign-on server). When a user logs out of one application, the user is automatically logged out of all other applications.

Note:

No change is needed in the logout URL configuration of existing applications that use the OSSO Agent.

The following processes take place with centralized logout for mod_osso:

1. Clicking Logout in an application takes the user to the page where logout occurs
2. When a user has signed off successfully, each of the applications listed on the centralized logout page has a check mark beside the application name.
3. A broken image beside an application name identifies an unsuccessful logout.
4. Once all of the application names activated in a session have a check mark, you can click Return to go to the application from which you initiated logout.
5. Delete the custom mod_osso agent cookies on logout.

29.6.2 Removing Custom mod_osso Cookies on Logout

The OSSO server cookie includes a list of partner IDs.

Process overview: When a user logs off from one partner application

The following processes take place when a user logs off from one partner application:

1. OSSO server pulls a list of the logout URLs.
2. OSSO server clears its own cookie.
3. OSSO server redirects to a customized JSP page (hosted on the OSSO server), and passes the list of logout URLs in the request.
4. The JSP page loads those logout URLs that contains some image tags of check marks, and as a result of the loading, the cookies for those mod_osso instances are cleared

However, on user logout, some custom cookies set by OAM Server through authentication response settings might not get deleted. However, you can edit `oam-config.xml` to configure the OAM Server to delete custom cookies set during authentication when a user logs out of OAM. For instance, when integrating with Oracle E-Business Suite, the `ORASSO_AUTH_HINT` cookie is set by the application and should be included in the `CookieNames` list (or the UCM cookie, for example).

Syntax (beneath `PluginClass` "Type=..."):

```
<Setting Name="CookieDelMap" Type="htf:map">
  <Setting Name="CookieNames" Type="xsd:string">COOKIE_NAME</Setting>
</Setting>
```

The following procedure guides as you edit the `CookieDelMap` element and add `CookieNames` as a single value or a comma-separated list of custom cookies to delete when a user logs out. This procedure also explains how to increment the `oam-config.xml` file version to propagate your change to all managed servers without restarting.

Note:

Work carefully. In general, Oracle recommends that you do not edit the `oam-config.xml` file. This, however, is a rare exception.

To delete custom `mod_ossoe` cookies on logout:

1. Back up `$DOMAIN_HOME/config/fmwconfig/oam-config.xml`.
2. In `oam-config.xml`, add (or edit) the `CookieDelMap` element and `CookieNames`.

For example:

```
<Setting Name="ResponsePluginSetting" Type="htf:map">
  <Setting Name="PluginClass" Type=... </Settings>
  <Setting Name="CookieDelMap" Type="htf:map">
    <Setting Name="CookieNames" Type="xsd:string">ORASSO_AUTH_HINT
  </Setting>
</Setting>
</Setting>
```

3. **Configuration Version:** Increment the `Version xsd:integer` as shown in the next to last line of this example (existing value (25, here) + 1):

Example:

```
<Setting Name="Version" Type="xsd:integer">
  <Setting xmlns="http://www.w3.org/2001/XMLSchema"
    Name="NGAMConfiguration" Type="htf:map:>
  <Setting Name="ProductRelease" Type="xsd:string">11.1.1.3</Setting>
  <Setting Name="Version" Type="xsd:integer">25</Setting>
</Setting>
```

4. Save the file.

29.7 Locating Other OSSO Agent Information

[Table 29-9](#) provides additional information on legacy OSSO agents with Access Manager.

Table 29-9 Other OSSO Information in this Guide

Topic	Location
Component Loggers	Table 7-3
OSSO Metrics in the DMS Console	"OSSO Agent Metrics"
Sessions and Session Management	Maintaining Access Manager Sessions

Registering and Managing 10g WebGates with Access Manager 11g

The *Oracle Fusion Middleware Installation Guide for Oracle Identity and Access Management* describes initial deployment of Access Manager 11g with the Oracle HTTP Server. When your enterprise includes Web server types other than Oracle HTTP Server you might want to use existing 10g WebGates or install fresh 10g WebGates for use with Access Manager. Also, you may want to switch from using the pre-registered IAMSuiteAgent to using a 10g WebGate to protect Oracle Identity Management Consoles.

The following topics describe how to install instances of 10g WebGates for use with Access Manager:

- [Prerequisites for Registering and Managing 10g WebGates with Access Manager 11g](#)
- [Introduction to 10g OAM Agents for Access Manager 11g](#)
- [Comparing Access Manager 11.1.2 and 10g](#)
- [Configuring Centralized Logout for IAMSuiteAgent](#)
- [Registering a 10g WebGate with Access Manager 11g Remotely](#)
- [Managing 10g OAM Agents Remotely](#)
- [Locating and Installing the Latest 10g WebGate for Access Manager 11g](#)
- [Configuring Centralized Logout for 10g WebGate with 11g OAM Servers](#)
- [Removing a 10g WebGate from the Access Manager 11g Deployment](#)

30.1 Prerequisites for Registering and Managing 10g WebGates with Access Manager 11g

Before you proceed with WebGate registration and management ensure the system level requirements are met.

- Review the latest certification matrix from Oracle Technology Network to locate the latest WebGates for your deployment at <http://www.oracle.com/technetwork/middleware/id-mgmt/fusion-certification-100350.html>
- Ensure that your Oracle Access Management Console is running

See Also:

- [Introduction to Policy Enforcement Agents](#)
 - [Introduction to 10g OAM Agents for Access Manager 11g](#)
-
-

30.2 Introduction to 10g OAM Agents for Access Manager 11g

The following topics provide an overview:

- [About IAMSuiteAgent: A Pre-Configured 10g WebGate Registered with Access Manager](#)
- [About Legacy Oracle Access Manager 10g Deployments and WebGates](#)
- [About Installing Fresh 10g WebGates to Use With Access Manager 11.1.2](#)
- [About Centralized Logout with 10g OAM Agents and 11g OAM Servers](#)

30.2.1 About IAMSuiteAgent: A Pre-Configured 10g WebGate Registered with Access Manager

IAMSuiteAgent is a Java agent filter that is pre-registered with Access Manager 11.1.2 out of the box. This agent and the companion Application Domain are installed pre-configured with Access Manager.

The IAMSuiteAgent is a domain-wide agent:

- Once Access Manager is deployed, the IAMSuiteAgent is installed on every server in the domain
- Unless disabled, every request coming into the WebLogic Application Server is evaluated and processed by the IAMSuiteAgent
- Certain IAMSuiteAgent configuration elements are available in the WebLogic Administration Console (in the Security Provider section) and others in the Oracle Access Management Console.

IAMSuiteAgent and related policies provide SSO protection for the IDM Administration Console, Oracle Identity Console, Oracle Access Management Console, and specific resources in the Identity Management domain.

You can replace the IAMSuiteAgent with a 10g WebGate to protect Oracle Identity Management Consoles and resources in the Identity Management domain, if you choose.

See [Configuring Centralized Logout for IAMSuiteAgent](#)

See [Replacing the IAMSuiteAgent with an 11g WebGate](#)

See [Bundled 10g IAMSuiteAgent Artifacts](#)

30.2.2 About Legacy Oracle Access Manager 10g Deployments and WebGates

11g OAM Servers support 10g WebGates that are registered to operate with Access Manager 11.1.2.

Such WebGates may include:

- Legacy 10g WebGates currently operating with Oracle Access Manager 10g.
- Legacy 10g WebGates configured as the Identity Assertion Provider (IAP) for SSO (for applications using IAP WebLogic container-based security with Oracle Access Manager 10g, as described in the *Securing Applications with Oracle Platform Security Services*).
- Legacy 10g WebGates currently operating with Web Applications coded for Oracle ADF Security and the OPSS SSO Framework

You can register these agents to use Access Manager SSO using either the Oracle Access Management Console or the remote registration tool. After registration, 10g WebGates directly communicate with Access Manager through a Java-based OAM Proxy that acts as a bridge.

See [Table 1-2](#).

See [Integrating Access Manager With Web Applications Using Oracle ADF Security and the OPSS SSO Framework](#).

The following topics outline the tasks that you must perform to set up an existing 10g WebGate to operate with Access Manager:

Task overview: Setting up a legacy 10g WebGate to operate with Access Manager:

1. [Registering a 10g WebGate with Access Manager 11g Remotely](#)
2. [Configuring Centralized Logout for 10g WebGate with 11g OAM Servers](#)
3. Optional: Deploying Applications in a WebLogic Container

See the *Securing Applications with Oracle Platform Security Services*.

30.2.3 About Installing Fresh 10g WebGates to Use With Access Manager 11.1.2

You can install fresh 10g WebGates for use with Access Manager 11g. 10g WebGates are available for a number of Web server platforms.

After installation and registration, 10g WebGates directly communicate with Access Manager through a Java-based OAM proxy that acts as a bridge.

Note:

When installing fresh 10g WebGates for Access Manager, Oracle recommends that you use the latest WebGates. Oracle also recommends that you install multiple WebGates for failover and load balancing.

There are several differences between installing a 10g WebGate to operate in an 11g Access Manager deployment versus installing the 10g WebGate in an 10g Oracle Access Manager deployment.

[Table 30-1](#) outlines these differences.

Table 30-1 Installation Comparison with 10g WebGates

10g WebGates in 11g Deployments	10g WebGates in 10g Deployments
1. Packages: 10g WebGate installation packages are found on media and virtual media that is separate from the core components.	1. Packages: 10g WebGate installation packages are found on media and virtual media that is separate from the core components.
2. Provisioning: Before installation, provision WebGate with Access Manager 11g. See Registering a 10g WebGate with Access Manager 11g Remotely .	2. Provisioning: Before installation, you create a WebGate instance in the Access System Console.
3. Associating with OAM Server: Occurs during WebGate registration (task 2 of this sequence).	3. Associating with AAA: Before installation, you associated the WebGate with an Access Server in the Access System Console.
4. Installing: Install the 10g WebGate in front of the application (or for Fusion Middleware, in front of the WebLogic Server).	4. Installing: Using 10g WebGate packages.
5. Language Packs: 10g WebGate Language Packs are supported with Access Manager.	5. Language Packs: 10g WebGate Language Packs could be installed during WebGate installation (or later).
6. Web Server Configuration: Copy Access Manager generated files to the WebGate installation directory path to update the Web server configuration.	6. Web Server Configuration: Automatic during WebGate installation (or manually after WebGate installation).
7. Certificate Installation: Copy files to the WebGate installation directory path.	7. Certificate Installation: You copied files to the WebGate installation directory path.
8. Forms: 10g forms provided with 10g WebGates cannot be used with 11g OAM Servers. Using 10g WebGates with 11g OAM Servers is similar in operation and scope to a resource WebGate (one that redirects in contrast to the Authentication WebGate). With a 10g WebGate and 11g OAM Server, the 10g WebGate always redirects to the 11g credential collector which acts like the authenticating WebGate.	8. Forms: Were provided for use in 10g deployments.
9. Single Log Out: Configure using information. See Configuring Centralized Logout for Sessions Involving 11g WebGates .	9. Centralized Log Out for Oracle Access Manager 10g.
10. Multi-Domain Support: Does not apply with Access Manager 11g.	10. Multi-Domain Support: Could be configured for Oracle Access Manager 10g.

The following overview lists the topics that describe 10g WebGate installation and registration tasks for Access Manager 11g in detail.

30.2.3.1 Task Overview: Registering and installing a 10g WebGate for Access Manager 11g

You must complete all the following procedures for a successful operation with Access Manager 11g:

1. Registering a 10g WebGate:

2. See [Locating and Downloading 10g WebGates for Use with Access Manager 11g](#)
3. See [Configuring Centralized Logout for 10g WebGate with 11g OAM Servers](#)
4. Optional: Deploying Applications in a WebLogic Container.
See *Securing Applications with Oracle Platform Security Services*.

30.2.4 About Centralized Logout with 10g OAM Agents and 11g OAM Servers

Logout is initiated when an application causes the invocation of the `logout.html` file configured for any registered 10g WebGate.

Generally speaking, during centralized logout with 10g WebGates the SSO Engine receives a `user-session-exists` request. The Session Management Engine looks up the session and responds that the session exists. The SSO engine sends a `Clear Session` request. The Session management engine clears the token and session context. The SSO engine sends a `Session Cleared` response.

Clearing the user token and the session context clears the server-side state, which includes clearing the `OAM_ID` cookie set on the server side. When the agent is notified, the agent clears the client-side state of the application. For more information, see [Configuring Centralized Logout for 10g WebGate with 11g OAM Servers](#).

See Also:

[Configuring Centralized Logout for IAMSuiteAgent](#)

30.3 Comparing Access Manager 11.1.2 and 10g

This topic provides a comparison against the 10g architecture for Access Manager and OSSO.

Included are the following topics:

- [Comparing Access Manager 11g versus 10g](#)
- [Comparing Access Manager 11g versus 10g Policy Model](#)

30.3.1 Comparing Access Manager 11g versus 10g

Access Manager 11g differs from 10g in that the identity administration features have been transferred to Oracle Identity Manager 11g (including user self-service and self registration, workflow functionality, dynamic group management, and delegated identity administration).

Access Manager 10g supported Single Sign-on using a single session cookie (the `ObSSOCookie`) that contained the user identity and session information required to access target resources that had the same or lower authentication level. The `ObSSOCookie` was encrypted and decrypted using a global shared secret key, the value of which was stored in the directory server. The `ObSSOCookie` was consumed by Access System components to verify the user identity and allow or disallow access to protected resources.

To close any possible security gaps, Access Manager 11g provides new server-side components that maintain backward compatibility with existing Access Manager 10g policy-enforcement agents (WebGates) and OSSO 10g agents (`mod_osso`). New Access Manager 11g WebGates are enhanced versions of 10g WebGates, that support a per-

agent secret key for the Single Sign-on (SSO) solution. Thus, cookie-replay type of attack are prevented. The 11g WebGates are all trusted at the same level; a cookie specific for the WebGate is set and cannot be used to access any other WebGate-protected applications on a user's behalf.

Unless explicitly stated, the term **WebGate** refers to both an out of the box WebGate or a custom Access Client.

Access Manager 11g uses technology from Oracle Coherence to provide centralized, distributed, and reliable session management.

[Table 30-2](#) provides a comparison of Access Manager 11g versus 10g.

For a list of names that have changed with Access Manager 11g:

See [Product and Component Name Changes with 11.1.2](#)

Table 30-2 Comparison: Access Manager 11g versus 10g

Feature	Access Manager 11g	10g
Agents	<ul style="list-style-type: none"> Agents: WebGate, Access Client, OpenSSO, OSSO (mod_osso), IAMSuiteAgent <p>Note: Nine Administrator languages are supported.</p>	<ul style="list-style-type: none"> Resource WebGate (RWG) Authentication WebGate (AWG) AccessGate Access Server Policy Manager Identity System <p>Note: Nine Administrator languages are supported.</p>
Server-side components	<ul style="list-style-type: none"> OAM Server (installed on a WebLogic Managed Server) Security Token Service and Identity Federation run on OAM Server 	<ul style="list-style-type: none"> Access Server Policy Manager Identity Server
Console	Oracle Access Management Console	Access System Console Identity System Console
Protocols that secure information exchange on the Internet	<p>Front channel protocols exchanged between Agent and Server: HTTP/HTTPS.</p> <p>11g WebGate secures information exchange using the Agent key.</p> <p>-See Also: Cryptographic keys.</p>	10g Agent information exchange is unsecured, in plain text.
Cryptographic keys	<ul style="list-style-type: none"> One per-agent secret key shared between 11g WebGate and OAM Server One OAM Server key, generated during Server registration <p>Note: One key is generated and used per registered mod_osso agent.</p>	One global shared secret key per Access Manager deployment which is used by all the 10g WebGates
Keys storage	<ul style="list-style-type: none"> Agent side: A per-agent key is stored locally in the Oracle Secret Store in a wallet file OAM Server side: A per-agent key, and server key, are stored in the credential store on the server side Security Token Service 	Global shared secret stored in the directory server only (not accessible to WebGate)

Table 30-2 (Cont.) Comparison: Access Manager 11g versus 10g

Feature	Access Manager 11g	10g
Cookies	Host-based authentication cookie. See Table 1-2	<ul style="list-style-type: none"> One domain-based ObSSOCookie for all WebGates (including the AWG), for both authentication and session management
Encryption / Decryption (The process of converting encrypted data back into its original form)	<p>Introduces client-side cryptography and ensures that cryptography is performed at both the agent and server ends:</p> <ol style="list-style-type: none"> WebGate encrypts obrareq.cgi using the agent key. Note: obrareq.cgi is the authentication request in the form of a query string redirected from WebGate to OAM Server. OAM Server decrypts the request, authenticates, creates the session, and sets the server cookie. OAM Server also generates the authentication token for the agent (encrypted using the agent key), packs it in obrar.cgi with a session token (if using cookie-based session management), authentication token and other parameters, then encrypts obrar.cgi using the agent key. Note: obrar.cgi is the authentication response string redirected from the OAM Server to WebGate. WebGate decrypts obrar.cgi, extracts the authentication token, and sets a host-based cookie. 	<ul style="list-style-type: none"> Token generation/ encryption, and validation/ decryption are delegated to the Access Server. Both obrareq.cgi and obrar.cgi are sent unencrypted, relying on the underlying HTTP(S) transport for security.
Session Management	<ul style="list-style-type: none"> See Managing Active Server-Side Sessions 	<ul style="list-style-type: none"> Single domain supported. Multi-domain: If a user idles out on one domain, but not on the authentication WebGate, the AWG cookie is still valid (re-authentication is not needed). A new cookie is generated with the refreshed timeout.
Client IP	<ul style="list-style-type: none"> Maintain this Client IP, and include it in the host-based OAMAuthnCookie. 	<ul style="list-style-type: none"> Include the original client IP inside the ObSSOCookie. If IP validation is configured, when cookie presented in later authentication or authorization requests this original client IP is compared with the presenter's IP. Rejection occurs if there is no match
Response token replay prevention	<ul style="list-style-type: none"> Include RequestTime (the timestamp just before redirect) in obrareq.cgi and copy it to obrar.cgi to prevent response token replay. 	N/A

Table 30-2 (Cont.) Comparison: Access Manager 11g versus 10g

Feature	Access Manager 11g	10g
Multiple network domain support	<p>Cross-network-domain single sign-on out of the box.</p> <p>Oracle recommends you use Oracle Federation for multiple network domain support.</p>	<p>A proprietary multiple network domain SSO capability predates Oracle Access Management Identity Federation. If this is implemented in your 10g deployment, register 10g Agents with Access Manager 11g to continue this support.</p> <ul style="list-style-type: none"> Single domain is supported. Once a user logs off from one WebGate, the domain cookie is cleared and the user is considered to be logged off the entire domain. Multi-domain SSO can be supported through chained customized logout pages.
Centralized log-out	<ul style="list-style-type: none"> The <code>logoutUrls</code> (10g WebGate configuration parameter) is preserved. 10g <code>logout.html</code> requires specific details for Access Manager 11g. 11g WebGate parameters are new: <ul style="list-style-type: none"> Logout Redirect URL Logout Callback URL Logout Target URL <p>See Configuring Centralized Logout for 11g WebGates.</p> <p>See</p>	<p><code>logout.html</code> requires specific details when using a 10g WebGate with Access Manager 11g.</p> <p>See Configuring Centralized Logout for 11g WebGates.</p> <ul style="list-style-type: none"> Single domain is supported. Once a user logs off from one WebGate, the domain cookie is cleared and the user is considered to be logged off the entire domain. Multi-domain SSO can be supported through chained customized logout pages.

30.3.2 Comparing Access Manager 11g versus 10g Policy Model

Access Manager 11g default behavior is to deny access when a resource is not protected by a policy that explicitly allows access.

Access Manager 10g provides authentication and authorization based on policies within a policy domain. Access Manager 10g default behavior allowed access when a resource was not protected by a rule or policy that explicitly denied access to limit the number of WebGate queries to the Access Server.

[Table 30-3](#) compares the Access Manager 11g policy model with the 10g model. Access Manager 11g default behavior is to deny access when a resource is not protected by a policy that explicitly allows access. In contrast, Access Manager 10g default behavior allowed access when a resource was not protected by a rule or policy that explicitly specified access.

Table 30-3 Comparing Access Manager 11g Policy Model versus 10g

Policy Elements	11g Policy Model	10g Policy Model
Policy Authoring	Oracle Access Management Console	Policy Manager
Policy Store	Database	LDAP directory server

Table 30-3 (Cont.) Comparing Access Manager 11g Policy Model versus 10g

Policy Elements	11g Policy Model	10g Policy Model
Domain	Application Domain	Policy Domain
Resources	<ol style="list-style-type: none"> 1. No URL prefixes. Resource definitions are treated as complete URLs. 2. Pattern matching (with limited features) for: '*' and '...' are supported 3. Resources need not be unique across domains. 4. Query-string protection for HTTP URLs. 5. Each HTTP resource is defined as a URL path, and associated with a host identifier. However, resources of other types are associated with a specific name (not a host identifier). 6. Non-HTTP resource types are supported, with definition of specific operations. Non-HTTP resource types are never associated with a host identifier. 7. Resources can designated as either Protected, Unprotected, or Excluded. 8. Custom resource types are allowed. 	<ol style="list-style-type: none"> 1. URL prefixes are defined in domains 2. Pattern matching for: { } * ... 3. Resources need not be unique across domains. 4. http resources can be protected based on URL query string contents and/or HTTP operation. 5. Non-HTTP resource types and operations can be defined.
Host identifiers	<ol style="list-style-type: none"> 1. Host Identifiers are defined outside of policies and are used while defining HTTP resources. 2. Host Identifiers are mandatory for defining HTTP resources. 	<ol style="list-style-type: none"> 1. Host Identifiers are defined outside of policies and are used while defining HTTP resources. 2. Host Identifiers are not mandatory, for defining HTTP resources, till there are no Host Identifiers defined in the system.

Table 30-3 (Cont.) Comparing Access Manager 11g Policy Model versus 10g

Policy Elements	11g Policy Model	10g Policy Model
Authentication Policies	<ol style="list-style-type: none"> 1. Authentication policies include resources, success responses, and an authentication scheme. 2. Authorization policies can also contain success responses, and time based, IP based and user-based conditions. 3. Only one authentication policy and one authorization policy can be associated with any resource. 4. Authentication and Authorization policies can evaluate to Success or Failure. 5. No Query Builder and no support for LDAP filters for (for retrieving matches based on an attribute of a certain display type, for example). 6. There is no notion of a default policy in an Application Domain. However, you can define a policy for resource: /.../* which can be used as a default policy within a determined scope). 7. Token Issuance Policies can be defined using resources and user- or partner-based conditions. See Token Issuance Policy Pages. 	<ol style="list-style-type: none"> 1. Authentication policies are simple and contain only authentication-scheme-based rule. 2. One resource can be associated with a set of Authorization policies. Evaluation of these policies can be based on an expression that combines the policies within the set using logical operators as desired. A resource can also be associated with multiple authentication policies and authorization policy sets. However, only one set applies. 3. An Authorization policy can evaluate to Success or Failure, or Inconclusive. 4. Users can be specified using LDAP filters. 5. Default authentication policy and authorization policy set can be defined for a policy domain. This policy is only applicable if there are no other applicable policies for a runtime resource in that domain. 6. There is no support for Token Issuance Policies.
Authentication Schemes	<p>Authentication Schemes are defined globally and can be shared (referenced within authentication policies).</p> <p>The trust level is expressed as an integer value between 0 (no trust) and 99 (highest level of trust).</p> <p>Note: Level 0 is unprotected. Only unprotected resources can be added to an Authentication Policy that uses an authentication scheme at protection level 0.</p> <p>See Also: .</p>	<p>Authentication Schemes can be defined outside of policies and can be referenced within authentication policies.</p>
Authorization Policy	<p>Each resource assigned to an Application Domain can be protected by only one authorization policy. Each policy can include one or more conditions and a rule.</p> <p>See Also: Rule, later in this table</p> <p>See Defining Authentication Policies for Specific Resources.</p>	<p>To protect resources, you define authorization rules that contain one or more conditions. You also configure authorization expressions using one or more authorization rules. A policy domain (and a policy) can each contain only one authorization expression.</p>

Table 30-3 (Cont.) Comparing Access Manager 11g Policy Model versus 10g

Policy Elements	11g Policy Model	10g Policy Model
Token Issuance Policy	By default, only a container for Token Issuance Policies is provided in a generated Application Domain. No Conditions or Rules are generated automatically. You must add these manually. See Also: Token Issuance Policy Pages .	N/A
Responses	Available for all policy types: <ol style="list-style-type: none"> 1. Authentication and Authorization success Responses can be defined within the policies. These are applied after evaluation of policies. 2. Cookie, Header, and Session responses are supported. 3. URL redirection can be set. 4. Response definitions are part of each policy. Response values can be literal strings or can contain additional embedded expressions that derive values from request, user, and session attributes. 	<ol style="list-style-type: none"> 1. Authentication and Authorization Responses can be defined within the policies for Success, Failure, and Inconclusive events. These are returned to the caller after evaluation of policies. 2. HTTP_HEADER and Cookie based variables can be set. 3. Redirect URLs can be set for Success and Failure events of authentication and authorization policy evaluations. 4. Response values can contain literal strings and list of user attribute values.
Cookies	See Also: Table 21-6 and Single Sign-On Cookies During User Login	See Also: Table 21-6 and Single Sign-On Cookies During User Login
Query String-based HTTP Resource Definitions	Supported within Access Policies: See Table 25-1 .	This Policy Model supports query string-based HTTP resource definitions within Access Policies. At run time, the OAM Proxy passes the Query String to the policy layer after URL encoding, just like for base resource URL. Only Query String that are part of HTTP GET requests are passed. Query String pattern does not apply to HTTP POST data.

Table 30-3 (Cont.) Comparing Access Manager 11g Policy Model versus 10g

Policy Elements	11g Policy Model	10g Policy Model
Rule	<p>Available for only Authorization and Token Issuance Policies.</p> <p>Each Authorization policy includes a rule that defines whether the policy allows or denies access to resources protected by the policy.</p> <p>The rule references Authorization conditions, described next.</p> <p>See Also: Introduction to Authorization Policy Rules and Conditions.</p>	<p>A policy is defined using authorization rules (among other policy elements).</p> <p>Authorization rules:</p> <ul style="list-style-type: none"> • Are defined outside of policies (but scoped within a policy domain) and are referenced in policies. • Appear in two places: 1) as part of default rules for the domain and 2) in policy definitions. <p>Each rule specifies who (which users, groups or IP4 addresses) is allowed or denied access and the time period in which this rule applies.</p> <p>There is also a provision to specify whether Allow takes precedence over Deny.</p>
Condition	<p>Available for only Authorization and Token Issuance Policies.</p> <p>Each Authorization policy rule references conditions that define to whom the rule applies, if there is a time Condition, and how evaluation outcomes are to be applied.</p> <p>Conditions are declared outside of rules and are referenced within a rule.</p> <p>See Also: Introduction to Authorization Policy Rules and Conditions.</p>	N/A

30.4 Configuring Centralized Logout for IAMSuiteAgent

The IAMSuiteAgent is pre-configured with the logout parameters needed to perform central logout against the OAM Server.

While similar to a 10g WebGate, the IAMSuiteAgent does not have a local logout.html page to be configured. Instead, the IAMSuiteAgent is delivered with a pre-deployed application (oamsso_logout), that is used by the agent to perform the logout.

The logout functionality for the IAMSuiteAgent requires that the oamsso_logout application is deployed in the Server where the IAMSuiteAgent is used. The initial installation adds this application to AdminServer and to OAM Servers. However, you must update this application's Target servers to include all those that are using the IAMSuiteAgent.

To configure logout for the IAMSuiteAgent:

1. Log in to the WebLogic Server Administration Console.
2. Navigate to Domain, Deployments, oamsso_logout, Targets.
3. Select all the Servers where the IAMSuiteAgent is enabled and where logout is performed.

For example, oim_server, oaam_admin, oaam_server, and so on.

4. Click **Save**.

5. Proceed to:
 - [Validating Authentication and Authorization in an Application Domain](#)
 - [Introduction to the Access Tester for Access Manager 11g](#)

30.5 Registering a 10g WebGate with Access Manager 11g Remotely

Whether you have a legacy 10g WebGate installed, or you are installing a fresh 10g WebGate instance to use with Access Manager 11g, you must register WebGate to use Access Manager 11g authentication and authorization services. You can use either the Oracle Access Management Console or the remote registration tool to perform this task. The remote registration tool enables you to specify all WebGate parameters before registration using a template.

The following procedure walks through provisioning using the remote registration tool, in-band mode. In this example, OAMRequest_short.xml is used as a template to create an agent named *my-10g-agent1*, protecting */**, and declaring a public resource, */public/index.html*. Your values will be different. You can use a full registration template to specify public, private, and excluded resources.

See [Performing Remote Registration for OAM Agents](#).

To use remote registration with a 10g WebGate for Access Manager 11g:

1. Acquire the remote registration tool and set up the script for your environment. For example:
 - a. Locate RREG.tar.gz file in the following path:

```
$ORACLE_HOME/oam/server/rreg/client/RREG.tar.gz
```
 - b. Untar RREG.tar.gz file to any suitable location. For example: `rreg/bin/oamreg`.
 - c. In the oamreg script (`oamreg.bat` or `oamreg.sh`), set the following environment variables based on your situation (client side or server side) and information.

See [Table 15-5](#).

```
OAM_REG_HOME = exploded_dir_for_RREG.tar/rreg
JAVA_HOME = Java_location_on_the_computer
```

2. Create the registration request:
 - a. Locate OAMRequest_short.xml and copy it to a new file. For example:

```
$OAM_REG_HOME/input/OAMRequest_short.xml
```

Copy: OAMRequest_short.xml
To: *my-10g-agent1.xml*
 - b. Edit *my-10g-agent1.xml* to include details for your environment. For example:

```
<OAMRegRequest>
  <serverAddress>http://ruby.uk.example.com:7001</serverAddress>
  <hostIdentifier>my-10g</hostIdentifier>
  <agentName>my-10g-agent1</agentName>
    <protectedResourcesList>
      <resource>/myapp/</
resource>      <resource>/myapp/.../*</resource>
    </protectedResourcesList>
</OAMRegRequest>
```

```

protectedResourcesList>                <publicResourcesList>
<resource>/public/index.html</resource>    </
publicResourcesList>                    <excludedResourcesList>
<resource>/excluded/index.html</resource>    </
excludedResourcesList>
  <autoCreatePolicy>true</autoCreatePolicy>
  <primaryCookieDomain>.uk.example.com</primaryCookieDomain>
  <logoutUrls>
    <url>/oamssso/logout.html</url>
  </logoutUrls>
</OAMRegRequest>

```

See [Creating Your Remote Registration Request](#)

3. Register the agent.

For example:

- a.** Locate the remote registration script.

Linux: rreg/bin/oamreg.sh

Windows: rreg\bin\oamreg.bat

- b.** From the directory containing the script, execute the script using inband mode.

For example:

```
$ ./bin/oamreg.sh inband input/my-10g-agent1.xml
```

```
Welcome to OAM Remote Registration Tool!
Parameters passed to the registration tool are:
Mode: inband
Filename: ...
```

- c.** When prompted, enter the following information using values for your environment:

```
Enter your agent username: username
Username: username
Enter agent password: *****
Do you want to enter a WebGate password?(y/n)
n
iv. Do you want to import an URIs file?(y/n)
n
```

- d.** Review the final message to confirm that this was a successful registration:

```
Inband registration process completed successfully! Output artifacts are
created in the output folder"
```

4. Ignore the ObAccessClient.xml file created during registration for now.

5. Log in to the Oracle Access Management Console and add resources for the new registration to the Application Domain.

See [Table 25-1](#).

- a.** Under Application Security, click the following links to reveal Search controls:

Access Manager
Application Domains

- b. Use the Search controls to locate the Application Domain in which your WebGate registration page is created, then click the name in the Results table to display the page.
 - c. Click the Resources tab and then Create.
 - d. **OAM Proxy Port**—Under Configurations, double click Server Instances and search for the server to get the OAM Proxy port details.
See [Table 6-3](#).
6. Proceed as needed for your environment:
- **Existing WebGate:** [Configuring Centralized Logout for 10g WebGate with 11g OAM Servers](#)
 - **Uninstalled WebGate:** [Locating and Installing the Latest 10g WebGate for Access Manager 11g](#)
 - **Optional:** [Managing 10g OAM Agents Remotely](#)

30.6 Managing 10g OAM Agents Remotely

You can update, validate, and delete OAM 10g Agents using remote registration templates and modes.

For more information, see [Remote Agent Update Modes and Templates](#).

To remotely update OAM 10g Agent registration:

1. Set up the registration tool.
See [Acquiring and Setting Up the Remote Registration Tool](#).
2. Update Agent:
 - a. Create your update request using the `OAMUpdateAgentRequest.xml` template.
 - b. On the computer hosting the Agent, run the following command with `agentUpdate` mode specify your own `*Request*.xml` as the input file. For example:

```
./bin/oamreg.sh agentUpdate input/*OAMUpdateAgentRequest.xml
```
 - c. Provide the registration Administrator user name and password when asked.
 - d. Confirm success with on-screen messages.
 - e. Relocate to the agent host `ObAccessClient.xml`:
From the AdminServer (Console) host: `/rreg/output/Agent_Name/`
To the Agent host: `$10gWG_install_dir/oblix/lib`.
 - f. Restart the server that is hosting this agent.
3. Validating Agent:
 - a. On the Agent host, run the following command in `agentValidate` mode.
For example:

```
./bin/oamreg.sh agentValidate agentname
```

- b. Provide the registration Administrator user name and password when asked.
 - c. Confirm success with on-screen messages.
4. Deleting an Agent:

- a. On the computer hosting the Agent, run the following `agentDelete` command. For example:

```
./bin/oamreg.sh agentDelete agentname
```

- b. Provide the registration Administrator user name and password when asked.
 - c. Confirm success with on-screen messages.

Success: On-screen message confirms

```
AgentDelete process completed successfully!
```

30.7 Locating and Installing the Latest 10g WebGate for Access Manager 11g

Use the procedures to install a fresh 10g WebGate for use with Access Manager 11g. Otherwise, skip this section and proceed as follows:

See [Configuring Centralized Logout for 10g WebGate with 11g OAM Servers](#).

Task overview - Installing the WebGate includes:

1. [Preparing for a Fresh 10g WebGate Installation with Access Manager 11g](#)
2. [Locating and Downloading 10g WebGates for Use with Access Manager 11g](#)
3. [Starting WebGate 10g Installation](#)
4. [Specifying a Transport Security Mode](#)
5. [Specifying WebGate Configuration Details](#)
6. [Requesting or Installing Certificates for Secure Communications](#)
7. [Updating the WebGate Web Server Configuration](#)
8. [Finishing WebGate Installation](#)
9. [Installing Artifacts and Certificates](#)
10. [Confirming WebGate Installation](#)

30.7.1 Preparing for a Fresh 10g WebGate Installation with Access Manager 11g

Before you start off with 10g WebGate installation with Access Manager 11g, ensure that the requirements such as installation location, user accounts, and transfer security mode are met.

[Table 30-4](#) outlines the installation requirements.

Table 30-4 Preparing for 10g WebGate Installation with Access Manager 11g

About the ...	Description
Latest Supported WebGates	Always use the latest supported 10g (10.1.4.3) WebGates with Access Manager 11g. However, if the desired 10g (10.1.4.3) WebGate is not provided, use the next latest WebGate (10g (10.1.4.2.0)). See Also: Locating and Downloading 10g WebGates for Use with Access Manager 11g .
Location for installation	Consider: <ul style="list-style-type: none"> • WebGate in front of the application server. • Applications using WebLogic Server container-managed security: In front of the WebLogic Application Server in which your application is deployed
User Accounts	The account that is used to install the WebGate is not the account that runs the WebGate: <ul style="list-style-type: none"> • The 10g WebGate should be installed using the same user and group as the Web server. • Unix: You can be logged in as root to install the WebGate. The WebGate can be installed using a non-root user if the Web server process runs as a non-root user
Root Level versus Site Level	<ul style="list-style-type: none"> • The WebGate can be installed at the root level or the site level. • Installing WebGate on multiple virtual sites amounts to only one instance of WebGate.
Transport Security Mode	Ensure that at least one OAM Server is configured to use the same mode as the agent to be installed. See Also Securing Communication Between OAM Servers and WebGates .
Computer Level or Virtual Web Server Level	The WebGate can be configured to run at either the computer level or the virtual Web server level. Do not install at both the computer level and the virtual Web server levels.
Oracle HTTP Server Web Server:	The 10g WebGate for Oracle HTTP Server is based on open source Apache. WebGate package names include: <ul style="list-style-type: none"> • OHS (based on Apache v1.3) • OHS2 (based on Apache v2) • OHS11g (based on Apache v2.2 and is not the subject of this chapter)
Apache Web Servers	Access Manager 11g provides a single package for components that support Apache with or without SSL enabled: <ul style="list-style-type: none"> • The APACHE2_WebGate supports v2 with or without SSL (and with or without reverse proxy enabled on Solaris and Linux). • See About Access Manager with Apache and IHS v2 Webgates. • The APACHE22_WebGate supports v2.2 with or without SSL (and with or without reverse proxy enabled on Solaris and Linux). <p>See also About Access Manager with Apache and IHS v2 Webgates.</p> <p>Note: For SSL-enabled communication, Access Manager supports Apache with mod_ssl only, not Apache-SSL. mod_ssl is a derivative of, and alternative to, Apache-SSL.</p>
IBM HTTP Server (IHS) v2 Web Servers:	IHS2_WebGate is powered by Apache v2 on IBM-AIX. Access Manager supports IHS v2 and IHS v2 Reverse Proxy servers with or without SSL enabled. See About Access Manager with Apache and IHS v2 Webgates .
Domino Web Servers:	Before you install the 10g WebGate with a Domino Web server, you must have properly installed and set up the Domino Enterprise Server R5. See Also: Prerequisites for Configuring Lotus Domino Web Servers for 10g WebGates

Table 30-4 (Cont.) Preparing for 10g WebGate Installation with Access Manager 11g

About the ...	Description
IIS Web Servers	<p>Before installing WebGate, ensure that your IIS Web server is <i>not</i> in lock down mode. Otherwise things will appear to be working until the server is rebooted and the metabase re-initialized, at which time IIS will disregard activity that occurred after the lock down.</p> <p>If you are using client certificate authentication, before enabling client certificates for the WebGate you must enable SSL on the IIS Web server hosting the WebGate.</p> <p>Setting various permissions for the /access directory is required for IIS WebGates only when you are installing on a file system that supports NTFS. For example, suppose you install the ISAPI WebGate in Simple or Cert mode on a Windows 2000 computer running the FAT32 file system. The last installation panel provides instructions for manually setting various permissions that cannot be set on the FAT32 fleshiest. In this case, these instructions may be ignored.</p> <p>Each IIS Virtual Web server can have it's own WebGate.dll file installed at the virtual level, or can have one WebGate affecting all sites installed at the site level. Either install the Webgate.dll at the site level to control all virtual hosts or install the Webgate.dll for one or all virtual hosts. You may also need to install the postgate.dll file at the computer level. The postgate.dll is located in the <code>\WebGate_install_dir</code>.</p> <p>See Installing the Postgate ISAPI Filter.</p> <p>If you perform multiple installations, multiple versions of this file may be created which may cause unusual Access Manager behavior. In this case, you should verify that only one webgate.dll and one postgate.dll exist.</p> <p>See Prerequisites for Configuring the IIS Web Server for 10g WebGates</p> <p>Removal: To fully remove a WebGate and related filters from IIS, you must do more than simply remove the filters from the list in IIS. IIS retains all of its settings in a metabase file. On Windows 2000 and later, this is an XML file that can be modified by hand. There is also a tool available, MetaEdit, to edit the metabase. MetaEdit looks like Regedit and has a consistency checker and a browser/editor. To fully remove a WebGate from IIS, use MetaEdit to edit the metabase.</p>
ISA Proxy Servers	<p>On the ISA proxy server, all ISAPI filters must be installed within the ISA installation directory. They can be anywhere within the ISA installation directory structure:</p> <ol style="list-style-type: none"> Before installing the WebGate on the ISA proxy server: <ul style="list-style-type: none"> Check for general ISAPI filter with ISA instructions on: <pre data-bbox="415 1352 1240 1409">http://msdn.microsoft.com/library/default.asp?url=/library/en-us/isa/isaisapi_5cq8.asp</pre> Ensure that the internal and external communication layers are configured and working properly. During installation you will asked if this is an ISA installation; be sure to: <ul style="list-style-type: none"> Indicate that this is an ISA proxy server installation, when asked. Specify the ISA installation directory path as the WebGate installation path. Use the automatic Web server update feature to update the ISA proxy server during WebGate installation. After WebGate installation, locate the file <code>configureISA4webgate.bat</code>, which calls a number of scripts and the process to configure the ISA server filters that must be added programmatically. <p>See Prerequisites for Configuring the ISA Server for 10g WebGates</p>

30.7.2 Locating and Downloading 10g WebGates for Use with Access Manager 11g

Obtain an 10g WebGate, if needed and ensure that you choose the appropriate installation package for your Web server.

To locate and download 10g WebGates for use with Access Manager 11g:

1. Review the latest Oracle Access Manager 10g certification information on the Oracle Technology Network at:

<http://www.oracle.com/technetwork/middleware/id-mgmt/fusion-certification-100350.html>

2. Go to Oracle Fusion Middleware 11gR1 Software Downloads at:

http://www.oracle.com/technology/software/products/middleware/htdocs/fmw_11_download.html

3. Click **Accept License Agreement**, at the top of the page.
4. From the **Access Manager WebGates (10.1.4.3.0)** row, click the download link for the desired platform and follow on-screen instructions.
5. Store the WebGate installer in the same directory with any 10g Access System Language Packs you want to install.
6. Proceed to [Starting WebGate 10g Installation](#).

30.7.3 Starting WebGate 10g Installation

Regardless of Web server type, the procedure is the same to start WebGate 10g installation. Installation options are identified and can be skipped if they do not apply to your environment.

During WebGate installation, information is saved at specific points. You can cancel WebGate installation processing if needed. However, if you cancel WebGate installation after being informed that the WebGate is being installed, you must uninstall the component.

Note:

On HP-UX and AIX systems, you can direct an installation to a directory with sufficient space using the `-is:tempdir` path parameter. The path must be an absolute path to a file system with sufficient space.

To start WebGate 10g installation:

1. On the computer to host WebGate 10g, log in as a user with Web server Administrator privileges.
2. Stop the Web server instance.
3. Launch the WebGate installer for your preferred platform, installation mode, and Web server. For example:

GUI Method:

Windows- Oracle_Access_Manager10_1_4_3_0_Win32_API_Webgate.exe

Console Method:

```
Solaris-./ Oracle_Access_Manager10_1_4_3_0_sparc-s2_API_Webgate
Linux-./ Oracle_Access_Manager10_1_4_3_0_linux_API_Webgate
```

where API refers to the API used by your Web server (for example, ISAPI for IIS Web servers).

- Dismiss the Welcome screen; follow on-screen instructions with Administrator privileges.
- Specify the installation directory for the WebGate.
- Linux or Solaris:** Specify the location of the GCC runtime libraries on this computer.
- Language Pack**—Choose a Default Locale and any other Locales to install, then click Next.
- Record the installation directory name in the preparation worksheet if you haven't already, then click Next to continue.

The WebGate installation begins, which may take a few seconds. On Windows systems, a screen informs you that the Microsoft Managed Interfaces are being configured.

The installation process is not yet complete. You are asked to specify a transport security mode. At this point, you cannot go back to restate information.

- Specify the location where you unzipped the previously downloaded GCC libraries, if needed.

30.7.4 Specifying a Transport Security Mode

Transport security between at least one OAM Server must match.

See [Securing Communication Between OAM Servers and WebGates](#).

To specify a transport security mode:

- Choose Open, Simple, or Cert for the WebGate.
- Proceed according to your specified transport security mode:
 - Simple or Certificate Mode**—Go to the following topic:
[Requesting or Installing Certificates for Secure Communications](#).
 - Open Mode**—Skip to the following topic:
See [Updating the WebGate Web Server Configuration](#).

30.7.5 Requesting or Installing Certificates for Secure Communications

You can request or install certificates for WebGate 10g. Requested certificates must be copied to the `\WebGate_install_dir\access\oblix\config` directory and then the WebGate Web server should be restarted.

If your Access Manager 11g environment uses Open mode transport security, you can skip to the following topic:

See [Updating the WebGate Web Server Configuration](#).

WebGate Certificate Request: Generates the request file (aaa_req.pem), which you must send to a root CA that is trusted by the OAM Server. The root CA returns signed certificates, which can then be installed for WebGate.

See [Securing Communication Between OAM Servers and WebGates](#).

To request or install certificates for WebGate 10g:

1. Indicate whether you are requesting or installing a certificate, then click Next and continue. For example:
 - Requesting a certificate, proceed with step 2.
 - Installing a certificate, skip to step 3.
2. Request a Certificate:
 - Enter the requested information, then click Next and issue your request for a certificate to your CA.
 - Record certificate file locations, if these are displayed.
 - Click Yes if your certificates are available and continue with step 3. Otherwise, skip to the following topic:
See [Updating the WebGate Web Server Configuration](#).
3. Install a Certificate During Installation: Specify the full paths to the following files, then click **Next**:

WebGate_install_dir\access\oblix\config

- cacert.pem the certificate request, signed by the Oracle-provided openSSL Certificate Authority
- password.xml contains the random global passphrase that was designated during installation, in obfuscated format. This is used to prevent other customers from using the same CA. Access Manager performs an additional password check during the initial handshake between the OAM Agent and OAM Server.
- aaa_key.pem contains your private key (generated by openSSL).
- aaa_cert.pem contains signed certificates in PEM format.
- Proceed to the following topic:
See [Updating the WebGate Web Server Configuration](#).

30.7.6 Specifying WebGate Configuration Details

You perform the following task using information provided during WebGate provisioning and registration with Access Manager 11g.

To provide WebGate configuration details:

1. Provide the information requested for the WebGate as specified in the Access System Console.
 - **WebGate ID**—Enter the agent name that you supplied during registration.

- **WebGate password**—Enter the password supplied during registration, if any. If no password was entered, leave the field blank.
- **Access Server ID**—Enter the name of the OAM Server with which this WebGate is registered, if desired, or use any name you choose.
- **Access Server Host Name**—Enter the DNS host name for the OAM Server with which this WebGate is registered
- **Port number**—Enter the port on which the OAM Proxy is running. If a port was not entered during provisioning, the default port is 3004.

2. Click **Next** to continue.

30.7.7 Updating the WebGate Web Server Configuration

Your Web server must be configured to operate with the WebGate. Oracle recommends automatically updating your Web server configuration during installation. However, procedures for both automatic and manual updates are included.

Note:

To manually update the Web server configuration:

1. Click **No** when asked if you want to proceed with the automatic update, then click **Next**.
2. Review the screen that appears to assist you in manually setting up your WebGate Web server.

See [Manually Configuring Your Web Server](#).

3. Return to the WebGate installation screen, click **Next**, and proceed to the following topic:

See [Registering a 10g WebGate with Access Manager 11g Remotely](#).

To automatically update your Web server configuration:

1. Click **Yes** to automatically update your Web server then click **Next** (or click **No** and view the following topic:

See [Manually Configuring Your Web Server](#).

- **Most Web servers**—Specify the absolute path of the directory containing the Web server configuration file.
- **IIS Web Servers**—The process begins immediately and may take more than a minute.

See [About WebGate Guidelines for IIS Web Servers](#).

You might receive special instructions to perform before you continue. Setting various permissions for the /access directory is required for IIS WebGates only when you are installing on a file system that supports NTFS. The last installation panel provides instructions for manually setting various permissions that cannot be set on the FAT32 file system. In this case, these instructions may be ignored.

- **Sun Web Servers**—Be sure to apply the changes in the Web server Administration console before you continue.

A screen announces that the Web server configuration has been updated.

2. Click Next and continue as follows:

See [Finishing WebGate Installation](#).

30.7.7.1 Manually Configuring Your Web Server

If, during WebGate installation, you declined automatic Web server updates, you must perform the task manually.

Note:

If the manual configuration process was launched during WebGate installation, you can skip Step 1 in the following procedure.

To manually configure your Web server for the WebGate:

1. Launch your Web browser, and open the following file, if needed. For example:

`\WebGate_install_dir\access\oblix\lang\langTag\docs\config.htm`

where `\WebGate_install_dir` is the directory where you installed the WebGate.

Note:

If you choose manual IIS configuration during 64-bit WebGate installation, you can access details in the following path

`WebGate_install_dir\access\oblix\lang\en-us\docs\dotnet_isapi.htm`

2. Select from the supported Web servers and follow all instructions, which are specific to each Web server type, as you:

- Make a back up copy of any file that you are required to modify during WebGate set up, so it is available if you need to start over.
- Ensure that you return to and complete all original setup instructions to enable your Web server to recognize the appropriate Access Manager files.

Note:

If you accidentally closed the window, return to step 1 and click the appropriate link again. Some setups start a new browser window or require you to open a Command window.

3. Continue as follows:

See [Finishing WebGate Installation](#).

30.7.8 Finishing WebGate Installation

The ReadMe information provides details about documentation and Oracle.

Note:

You may need to install a 64-bit IIS WebGate.

See [Finishing 64-bit Webgate Installation](#).

To finish the WebGate installation:

1. Review the ReadMe information, then click Next to dismiss it.
2. Click Finish to conclude the installation.
3. Restart your Web server to enable configuration updates to take affect.
 - **IIS Web Servers**—Consider using `net stop iisadmin` and `net start w3svc` after installing the WebGate to help ensure that the Metabase does not become corrupted.
 - **Security-Enhanced Linux:** Run the `chcon` commands for the WebGate you just installed on this platform.
4. Proceed with following topics before installing artifacts and certificates:
 - **Native POSIX Thread Library:** When installing Access Manager WebGate for use with NPTL, there is no need to set the environment variable `LD_ASSUME_KERNEL` to 2.4.19.
 - **Apache2, OHS2, IHS2 Web Servers:**
See [About Access Manager with Apache and IHS v2 Webgates](#).
 - **IIS Web Servers:** Consider using `net stop iisadmin` and `net start w3svc` after installing the WebGate to help ensure that the Metabase does not become corrupted.
See also [About WebGate Guidelines for IIS Web Servers](#).
 - **ISA Web Servers:**
See [About Access Manager and the ISA Server](#) .
 - **Lotus Domino Web Servers:**
See [Prerequisites for Configuring Lotus Domino Web Servers for 10g WebGates](#).
5. Proceed to the following topic:
See [Installing Artifacts and Certificates](#) .

30.7.9 Installing Artifacts and Certificates

The `ObAccessClient.xml` file is one result of product of provisioning. After WebGate installation, you must copy the file to the WebGate installation directory path.

If you received signed WebGate 10g certificates after installing WebGate, you can use the following procedure to install these as well.

Prerequisites:

Configure your Web server.

To install artifacts (and certificates) for WebGate 10g:

1. Copy `ObAccessClient.xml`

- **From:** `$WLS_DOMAIN_HOME/output/AGENT_NAME`
- **To:** `$WebGate_install_dir/oblix/lib`

Copy `password.xml`

- **From:** `$WLS_DOMAIN_HOME/output/AGENT_NAME`
- **To:** `$WebGate_install_dir/oblix/config`

2. Copy `aaa_key.pem` and `aaa_cert.pem`:

- **From:** `$IDM_DOMAIN_HOME/output/AGENT_NAME`
- **To:** `$WebGate_install_dir/oblix/config/simple`

The `simple` directory must be created before copying the artifacts.

3. Restart the WebGate Web server.

30.7.10 Confirming WebGate Installation

After WebGate installation and Web server updates, you can enable WebGate diagnostics to confirm that your WebGate is running properly.

To review WebGate diagnostics:

1. Confirm Access Manager 11g components are running.
2. Specify the following URL for WebGate diagnostics. For example:

Most Web Servers—`http(s)://hostname:port/access/oblix/apps/webgate/bin/webgate.cgi?progid=1`

IIS Web Servers—`http(s)://hostname:port/access/oblix/apps/webgate/bin/webgate.dll?progid=1`

where *hostname* refers to the name of the computer hosting the WebGate; *port* refers to the Web server instance port number.

3. The WebGate diagnostic page should appear.

- **Successful:** If the WebGate diagnostic page appears, the WebGate is functioning properly and you can dismiss the page.
See [Configuring Centralized Logout for 10g WebGate with 11g OAM Servers](#).

- **Unsuccessful:** WebGate should be uninstalled and reinstalled.
See [Removing a 10g WebGate from the Access Manager 11g Deployment](#).

30.8 Configuring Centralized Logout for 10g WebGate with 11g OAM Servers

You need to perform the following tasks to configure centralized logout for 10g WebGate with 11g OAM servers:

- [About Centralized Logout with 10g OAM Agents and 11g OAM Servers](#)
- [Centralized Logout Script for 10g WebGates with 11g OAM Servers](#)
- [Configuring Centralized Logout for 10g WebGates with Access Manager](#)

30.8.1 About Centralized Logout Processing for 10g WebGate with 11g OAM Server

The Access Manager centralized logout process occurs when the application is deployed on the Web server for which the protecting 10g WebGate is configured.

Logout is initiated when an application causes the invocation of the `logout.html` file configured for the OAM agent (in this case, a 10g WebGate).

30.8.1.1 Process Overview: Centralized Logout for 10g WebGate with 11g OAM Server

Here is an overview of the process followed for centralized logout for 10g WebGate with 11g OAM Server.

1. The application causes invocation of the `logout.html` file configured for the 10g WebGate.

The application then passes `end_url` as a query string to `logout.html`. The `end_url` parameter could either be a URI or a URL.

For example:

```
/oamssso/logout.html?end_url=/welcome.html  
or  
/oamssso/logout.html?end_url=http://my.site.com/welcome.html
```

2. WebGate clears the `ObSSOCookie` for its domain and loads the `logout.html` script.
3. If the `end_url` parameter does not include *host:port*, the `logout.html` script gets the *host:port* of the local server and constructs the `end_url` parameter as a URL. For example:

```
http://serverhost:port/oam/server/logout?end_url=http://my.site.com/  
welcome.html
```

4. Logic in `logout.html` redirect to the OAM Server. For example:

```
http://myoamserverhost:port/oam/server/logout?end_url=http://my.site.com/  
welcome.html
```

5. The OAM Server executes logout as follows:
 - a. Cleans up the session information associated with the user at the server side.
 - b. Validates the `end_url` and sends a page with callback URLs to the user's browser.

Note:

The Logout Callback URL is specified in the expanded OAM Agent registration page.

See [Creating OAM WebGate Page and Parameters](#).

You can locate the remote registration template as follows:

See [Table 15-3](#).

- c. From the callback page, a new request is initiated to a specific URI on each WebGate. When this request reaches the specific WebGate in the specific domain, the ObsSOCookie for that domain is cleared.
- d. The user is redirected to the `end_url` in the logout script. However, if the `end_url` parameter is not present, an appropriate message is sent by the OAM Server.

See [Centralized Logout Script for 10g WebGates with 11g OAM Servers](#).

30.8.2 Centralized Logout Script for 10g WebGates with 11g OAM Servers

With an 10g WebGate, the `logout.html` script is required for both single- and multiple DNS-domain centralized logout processing. The `logout.html` activates JavaScripts that perform the actual logout.

Note:

11g WebGates do not use the `logout.html` script and instead require additional details in their Agent registration configuration.

See [Configuring Centralized Logout for 10g WebGate with 11g OAM Servers](#).

The following example shows the `logout.html` script that you can use as a template by editing certain lines for your own environment, which are described at the top of the script. For instance, `SERVER_LOGOUTURL` must be changed. Additional information is provided after the following example:

logout.html Script

```
<html>
<head>
<script language="javascript" type="text/javascript">
////////////////////////////////////
//Before using, you need to change the values of:
//a. "oamserverhost" to point to the host where the OAM Server is running.
//b. "port" to point to the port where the OAM Server is running.
////////////////////////////////////
var SERVER_LOGOUTURL = "http://oamserverhost:port/oam/server/logout";
////////////////////////////////////

function handleLogout() {

    //get protocol used at the server (http/https)
    var webServerProtocol = window.location.protocol;
    //get server host:port
    var webServerHostPort = window.location.host;
    //get query string present in this URL
    var origQueryString = window.location.search.substring(1);
    var newQueryString = "";

    //vars to parse the querystring
    var params = new Array();
    var par = new Array();
    var val;

    if (origQueryString != null && origQueryString != "") {
        params = origQueryString.split("&");
        for (var i=0; i<params.length; i++) {
```

```

        if (i == 0)
            newQueryString = "?";

        if (i > 0)
            newQueryString = newQueryString + "&";

        par = params[i].split("=");

        //prepare a new query string, if the end_url value needs to be changed
        newQueryString = newQueryString + (par[0]);
        newQueryString = newQueryString + "=";
        val = par[1];

        if ("end_url" == par[0]) {
            //check if val (value of end_url) begins with "/" or "%2F" (is it an URI?)
            if (val.substring(0,1) == "/" || val.substring(0,1) == "%") {
                //modify the query string now
                val = webServerProtocol + "/" + webServerHostPort + val;
            }
        }
        newQueryString = newQueryString + val;
    }
}
//redirect the user to this URL
window.location.href = SERVER_LOGOUTURL + newQueryString;
}
</script>
</head>

<body onLoad="handleLogout();">

</body>
</html>

```

30.8.2.1 Process Overview: Logic in logout.html

Here is an overview of the process that is followed in the logout.html script.

Following is the process flow:

1. Gets the host and port from the incoming request.
2. Gets the end_url parameter from the query string.
If the end_url parameter is not a URL, then the logout.html script constructs a URL using the host and port from task 1.
See "[Guidelines for the end_url parameter in logout.html](#)".
3. Redirects to the OAM Server logout URL (SERVER_LOGOUTURL). For example: `http://myoamserver/host:port/oam/server/logout`.
 - Use the end_url constructed in process 2 as the query string.
 - Preserve all other query string parameters in the query string.

30.8.2.2 Guidelines for the end_url parameter in logout.html

The end_url parameter can be either a URI or an URL.

- If the `end_url` query string is a URI, without host and port, then the `logout.html` must construct the URL by determining the host and port of the Web Server where `logout.html` is hosted. For example:

```
http://myoamserverhost:port/oam/server/logout?end_url=http://my
.site.com/welcome.html
```

- If the `end_url` parameter is a URL with the host and port, the `logout.html` script simply passes that on without reconstructing it.

Note:

An ADF application must pass the `end_url` parameter indicating where to redirect the user after logout.

See [Configuring Centralized Logout for Oracle ADF-Coded Applications](#).

```
</app context root>/adfAuthentication?logout=true&end_url=<any uri>
```

[Table 30-5](#) illustrates how a logout link in the `logout.html` file might be specified:

Table 30-5 Sample end_url Parameter Specifications

As a ...	Sample end_url Value
URI	<code>/oamssso/logout.html?end_url=<someUri></code> For example: <code>/oamssso/logout.html?end_url=/welcome.html</code>
URL	<code>/oamssso/logout.html?end_url=<someUrl></code> For example: <code>/oamssso/logout.html?end_url=http://my.site.com/welcome.html</code>

30.8.3 Configuring Centralized Logout for 10g WebGates with Access Manager

You can configure centralized logout for 10g WebGates with Access Manager.

Note:

Optional tasks or those required for only multiple DNS domain logout are identified and can be skipped unless needed.

Securing Applications with Oracle Platform Security Services includes a sample procedure that includes steps for deploying an application in a WebLogic Server domain.

Task overview - Configuring centralized logout for 10g WebGates:

1. Create a default logout page (`logout.html`) and make it available on the WebGate installation directory:

- a. Create and edit `logout.html` for the WebGate based on the `logout.html` script provided in [Centralized Logout Script for 10g WebGates with 11g OAM Servers](#).

- b. Store your `logout.html` script in the following directory path:

```
WebGate_install_dir/oamssso/logout.html
```

Note:

If the `logout.html` file is located elsewhere, ensure that the logout link is correctly specified in the agent registration to point to the correct location of the `logout.html` file.

- c. Proceed with following steps, as needed.
2. Ensure that the `logout.html` (from Step 1) redirects the user to this central logout URI, `"/oam/server/logout"` on the 11g OAM Server.
3. **Optional:** Allow the application to pass the `end_url` parameter indicating where to redirect the user after logout.

See [Guidelines for the `end_url` parameter in `logout.html`](#).

4. Check the Web server file for which the 10g WebGate is configured and perform the appropriate step:

- OHS Web server, `httpd.conf` file: If the following lines exist, delete them:

```
<LocationMatch "/oamssso/*">  
Satisfy any  
</LocationMatch>
```

- Other Web servers, configuration file: Add the following line:

```
Alias /oamssso "WebGateInstallationDirectory/oamssso"
```

30.9 Removing a 10g WebGate from the Access Manager 11g Deployment

You can remove the 10g WebGate from the Access Manager 11g deployment, if needed.

Note:

Deleting an agent registration does not remove the associated host identifier, Application Domain, resources, or the agent instance.

Considerations

Web Server Configuration Changes: Web server configuration changes must be manually reverted after uninstalling the WebGate. For more information about what is added, see the appropriate chapter for your Web server.

WebGate IIS Filters: To fully remove a WebGate and related filters from IIS, you must do more than simply remove the filters from the list in IIS. IIS retains all of its settings in a metabase file. On Windows 2000 and later, this is an XML file that can be modified by hand.

Prerequisites

Evaluate the Application Domain, resources, and policies associated with this agent and ensure that these are configured to use another agent or that they can be removed.

To uninstall the 10g WebGate:

1. Turn off the Web server for the WebGate you will remove.

Note:

If you don't turn off the Web server, uninstall might fail and the backup folder will not be removed. If this happens, you need to manually remove the backup folder.

2. On the WebGate registration page in the Oracle Access Management Console, click the Disable box beside the State option to disable the WebGate.

3. Language Packs: Remove installed Language Packs (except the one selected as the default Administrator language (locale)) as follows:

- Locate the appropriate Language Pack file in the component's uninstall directory. For example:

```
WebGate_install_dir\uninstIdentityLP_fr-fr
\uninstaller.exe
```

- Run the Language Pack Uninstaller program to remove the files.
 - Repeat this process to remove the same Language Pack from associated components.
 - Stop and restart WebGate Web server to re-initialize proper language support.
 - Repeat this process to remove each Language Pack (except the one selected as the default Administrator language (locale)).
4. Perform the following steps to remove 10g WebGate configuration data:
 - If you have only one instance of an Access Manager component, complete step 4 to remove it.
 - If you have multiple instances of a component, see also step 5.

5. Locate and run the Uninstaller program for the specific component to remove Access Manager files. For example:

```
WebGate_install_dir\access\_uninstWebGate\uninstaller.exe
```

Note:

On UNIX systems, use `uninstaller.bin`

6. Multiple Instances: If you have multiple WebGate instances and want to remove one or all of them, you must use a specific method for your platform:

- **Windows:** The last component can be uninstalled from Add/Remove programs. Others can be uninstalled by running the uninstall program from the \access \uninstComponent directory.
 - **UNIX:** You must always run uninstaller.bin.
7. Remove Access Manager-related updates to your Web server configuration.
See [About Oracle HTTP Server and Access Manager](#).
See [About Access Manager and the ISA Server](#) .
See [About WebGate Guidelines for IIS Web Servers](#).
See [Installing the Domino Web Server](#).
 8. Restart the Web server.
 9. Remove the *WebGate_install_dir* directory if it remains, especially if you plan to reinstall it.

Configuring Apache, OHS, IHS for 10g WebGates

Oracle provides WebGates for Web servers powered by Apache v2. This includes Apache, Oracle HTTP Server, and IBM HTTP Server (IHS).

The following topics describe how to configure the following Web server types:

- [About Oracle HTTP Server and Access Manager](#)
- [About Access Manager with Apache and IHS v2 Webgates](#)
- [About Apache v2 Architecture and Access Manager](#)
- [Requirements for Oracle HTTP Server, IHS, Apache v2 Web Servers](#)
- [Preparing Your Web Server](#)
- [Activating Reverse Proxy for Apache v2 and IHS v2](#)
- [Verifying httpd.conf Updates for Webgates](#)
- [Tuning Oracle HTTP Server Webgates for Access Manager](#)
- [Tuning OHS / Apache Prefork and Worker MPM Modules for OAM](#)
- [Starting and Stopping Oracle HTTP Server Web Servers](#)
- [Tuning Apache/IHS v2 Webgates for Access Manager](#)
- [Removing Web Server Configuration Changes After Uninstall](#)
- [Helpful Information about Building an Apache Release and Source Code](#)

31.1 Prerequisites for Configuring Apache, OHS, IHS for 10g WebGates

Ensure that your Oracle Access Management Console is running.

Also, you need to be familiar with:

- ["Introduction to Policy Enforcement Agents"](#)
- ["About Installing Fresh 10g WebGates to Use With Access Manager 11.1.2"](#)

31.2 About Oracle HTTP Server and Access Manager

Access Manager Web component package names for Oracle HTTP Server are designated with OHS.

- Oracle HTTP Server 11g is based on Apache v2.2; package names include OHS11g. For example:

Oracle_Access_Manager10_1_4_3_0_platform_OHS11g_Webgate

- Oracle HTTP Server 10g R2 (10.1.2) and 10g (10.1.3.1.0) provide packages based on Apache v1.3 and Apache v2.0:

Apache v2.0-based packages include OHS2. For example:

Oracle_Access_Manager10_1_4_3_0_platform_OHS2_Webgate

Apache v1.3-based packages include OHS. For example:

Oracle_Access_Manager10_1_4_3_0_platform_OHS_Webgate

The following Oracle HTTP Server releases operate with Access Manager:

Oracle HTTP Server 11g: Access Manager Webgates Oracle HTTP Server 11g can be used like Webgates for any other Web server. In addition, this Webgate for Oracle HTTP Server 11g is a key component when configuring enterprise-level single sign-on for Oracle Fusion Middleware 11g. For details, see the *Oracle HTTP Server Administration Guide 11g Release 1 (11.1.1)*.

Oracle HTTP Server 10g (10.1.3.1.0): Provides two packages (one based on Apache v1.3 and another based on Apache v2.0). Webgates can be installed on a standalone Oracle HTTP Server. OHS2 Webgate must be installed on the Oracle Application Server to enable integration with Oracle single sign-on. During installation, the Webgate is installed as a module on OHS2.

Be sure to familiarize yourself with Oracle HTTP Server Web component requirements.

See [Preparing Your Web Server](#).

31.3 About Access Manager with Apache and IHS v2 Webgates

Access Manager provides components for Apache v2 Web servers and the IBM HTTP Server in addition to the Oracle HTTP Server. The IBM HTTP Server (IHS2) is a variation of Apache v2.

Unless otherwise stated, the following information applies to the following components:

- Apache v2.0.5.2 Webgate
- Apache v2.0.48 Webgate, including reverse proxy if you choose to activate this capability.
- Apache v2.0.47 Webgate for the IBM HTTP Server (IHS2) powered by Apache, including reverse proxy if you choose to activate this capability.

Note:

For the latest Access Manager certification information, see:

<http://www.oracle.com/technetwork/middleware/ias/downloads/fusion-certification-100350.html>

Each platform-specific installation package supports both plain and SSL-capable Apache modes. The number 2 in a file name indicates that this component is based on Apache v2. For example:

AIX: Oracle_Access_Manager10_1_4_3_0_power-aix_IHS2_Webgate

Linux: Oracle_Access_Manager10_1_4_3_0_linux_Apache2_Webgate

Solaris: Oracle_Access_Manager10_1_4_3_0_sparc-s2_Apache2_Webgate

Windows: Oracle_Access_Manager10_1_4_3_0_Win32_APACHE2_Webgate

Earlier Access Manager releases included separate platform-specific installation packages for plain versus SSL-capable modes. For example, two Webgate files were provided for each platform: the APACHE_Webgate, and the APACHESSL_Webgate.

There have been no functional changes to Access Manager components to support these Web servers. Access Manager authentication occurs through the Webgate using HTTP basic, form, or SSL client certificates. Authorization for Web resources by authenticated users, as well as simple and multi-domain SSO with other Web servers or applications, also occurs through the Webgate.

31.3.1 About the Apache HTTP Server

The Apache HTTP Server is an open-source HTTP Web server project of the Apache Software Foundation. The project goal is to provide a secure, efficient and extensible server and HTTP services that meet current HTTP standards.

For more information, see "[About Apache v2 Architecture and Access Manager](#)".

31.3.2 About the IBM HTTP Server

The IBM HTTP Server (IHS) is a variation of Apache v2. Portions of the IBM HTTP Server are based on software developed by The Apache Group. The IBM HTTP Server component also includes software developed by the OpenSSL Project and software developed by Eric Young.

Details about the Apache architecture and Access Manager, discussed in "[About Apache v2 Architecture and Access Manager](#)", apply to IHS with the following exceptions:

- Previous versions of IHS required a separate IDS Client to use the mod_ibm_ldap module. With IHS powered by Apache v2.0.47, this is not a requirement.
- IHS v2.0.47 supports FIPS 140-2. FIPS support is disabled by default. To enable FIPS support, just add the SSLFIPSEnable directive to the httpd.conf file. Similarly, use SSLFIPSDisable directive to disable FIPS support.
- On AIX, ensure that the appropriate runtime library is installed before you install IHS v2.0.47.

For example, on AIX 5.1, the x1C.rte 6.0 runtime library (for example, x1C.rte.6.0.0.0) must be installed before you install IHS v2.0.47. This library is required on AIX to install and use SSL with IHS v2. You can download this library from the following Web site:

<http://www-912.ibm.com/eserver/support/fixes/fcgui.jsp>

31.3.3 About the Apache and IBM HTTP Reverse Proxy Server

A reverse proxy appears like an ordinary Web server.

Typically, a reverse proxy is used in the following situations:

- To provide Internet users with access to a server behind a firewall

- To balance the load among several back-end servers, or to provide caching for a slower back-end server
- To bring several servers into the same URL space

The proxy_module implements a proxy/gateway for Apache and IHS powered by Apache. Appearing like an ordinary Web server, a reverse proxy does not require the client have any special configuration. The client makes requests as usual for content in the name-space of the reverse proxy. It is the reverse proxy that decides where those requests are sent. Content is returned as if the reverse proxy was the origin.

Note:

The proxy_module can be used to implement a proxy capability for FTP, CONNECT (for SSL), HTTP/0.9, HTTP/1.0, and HTTP/1.1. However, only the reverse proxy capability is supported with the Webgate.

See "[Requirements for Apache v2 Web Servers](#)".

31.4 About Apache v2 Architecture and Access Manager

The Apache v2 Web server provides a hybrid multi-threaded, multi-process architecture that is compatible with the thread-safe Access Manager libraries.

Note:

Unless explicitly stated otherwise, all details in this discussion apply equally to Apache v2 and IHS v2 Web Servers for 10g Webgates.

In addition to the standard set of modules, the Apache v2 Web server includes Multi-Process Modules (MPMs) to bind network ports on the computer and to accept and process requests. The appropriate MPM must be compiled into the server and activated before you install an Apache or IHS v2 Webgate:

- **On Windows:** mpm_winnt is the default MPM on Windows platforms. mpm_winnt can use native networking features rather than the POSIX layer used in Apache 1.3.
- **On UNIX:** The prefork MPM is the default MPM for Apache v2 Web servers on UNIX platforms. The prefork MPM implements a non-threaded, pre-forking Web server that handles requests in a manner similar to Apache v1.3.

Note:

If you compile Apache on UNIX with the mpm_worker_module for Webgate, you need to optimize the default pthread stacksize for Webgate to ensure optimal performance during multithreaded server implementation, as described in "[Apache v2 on UNIX with the mpm_worker_module for Webgate](#)".

- **On AIX:** The worker MPM is the default MPM for IHS v2 on the AIX platform. The worker MPM implements a hybrid multi-process, multi-threaded server. The

most important directives used to control this MPM are `ThreadsPerChild` and `MaxClients`.

See "[Tuning Apache/IHS v2 Webgates for Access Manager](#)".

The Apache v2 Web server includes an `lonhjApache Portable Runtime (APR)` library that provides an interface to platform-specific implementations, assures API developers predictable if not identical behavior regardless of platform, and eliminates the need for conditional compilation `#ifdefs`. Although backward compatibility is supported with the `include/apu_compat.h` file, using the Apache v2 APR is recommended.

See your Apache v2 documentation.

See "[Tuning Apache/IHS v2 Webgates for Access Manager](#)".

The Apache architecture affects Access Manager components in different ways, as discussed in the following topics.

31.4.1 Requirements or Webgates Installed with IHS and Apache v2

The following requirements are applicable when Webgates are installed with IHS and Apache v

- There is no shared cache between processes.
- Each process maintains its own connections to the Access Server. Therefore, you should limit the number of Webgate connections. This issue is partially affected by the performance of the systems running the Web servers and Access Servers.

Note:

Webgates for Apache v2 (and derivatives) can be used in installations that contain Webgates for other Web servers.

If you compile Apache on UNIX with the `mpm_worker_module` for Webgate, you need to optimize the default `pthread stacksize` for Webgate to ensure optimal performance during multithreaded server implementation as described in "[Apache v2 on UNIX with the mpm_worker_module for Webgate](#)".

31.4.2 Limitations of Apache and IHS v2 Web Servers

Limitations of the Apache v2 Web server do not allow the form-based authentication scheme plug-ins to pass variables.

Plug-ins that are configured for the Access Manager form-based authentication scheme do not pass variables when:

- the optional challenge parameter, `passthrough:Yes`, is included in the authentication scheme to pass login credentials through to a post-processing program.
- the form action is a CGI script that dumps all headers and variables passed to it and the method is called using the HTTP POST method.

For example:

```
<html>
<form name="myloginform" action="/access/...cgi" method="post">
```

31.5 Requirements for Oracle HTTP Server, IHS, Apache v2 Web Servers

Access Manager HTML pages use UTF-8 encoding. If the `AddDefaultCharset` directive enables a character set other than UTF-8, Access Manager HTML pages are garbled.

Apache-based Web servers, including Apache, Oracle HTTP Server, and IBM HTTP Server (IHS) allow Administrators to specify a default character set for all HTML pages sent out using the `AddDefaultCharset` directive. This directive overrides any character specified by the application generating the HTML pages.

Oracle recommends that you specify the `AddDefaultCharset` directive in the Web server configuration file (`httpd.conf`) as follows to ensure the correct display of Access Manager HTML pages:

```
AddDefaultCharset Off
```

See your Web server documentation for more information about this directive.

The following topics provide additional details you should be aware of:

- [Requirements for IHS2 Web Servers](#)
- [Requirements for Apache and IHS v2 Reverse Proxy Servers](#)
- [Requirements for Apache v2 Web Servers](#)

31.5.1 Requirements for IHS2 Web Servers

This discussion identifies specific requirements for IHS v2 with Access Manager. With IHS v2, you do not compile any source code to get the binaries.

The following requirements apply to IHS v2 Web servers:

- For an SSL capable configuration on AIX, the `xLC.rte.6.0` runtime library is required.
- For an SSL capable configuration, the `GSKit7` is required and can be downloaded from <https://techsupport.services.ibm.com/server/aix.fdc>.

31.5.2 Requirements for Apache and IHS v2 Reverse Proxy Servers

The `proxy_module` implements a proxy/gateway. The client requires no special configuration. Although the `proxy_module` can be used to implement a proxy capability for FTP, CONNECT (for SSL), HTTP/0.9, HTTP/1.0, and HTTP/1.1, only the reverse proxy capability is supported with certain Access Manager Apache and IHS v2 Webgates.

For Apache Web Servers: To use reverse proxy functions with Access Manager, you need to include the proxy module in the configure command. For example:

```
--enable-proxy: Apache proxy module --enable-proxy-connect: Apache proxy  
CONNECT module
```

```
--enable-proxy-ftp: Apache proxy FTP module
```

```
--enable-proxy-http: Apache proxy HTTP module
```

You also need to load `mod_proxy` and the `mod_proxy_http` module into the server dynamically. A reverse proxy is activated using the `ProxyPass` directive or the `[P]` flag to the `RewriteRule` directive.

For IHS Web Servers: After installing the IHS Web server, reverse proxy configurations must be completed in the httpd.conf file in the following directory:

IHS_install_dir/conf directory

For more information, see "[Activating Reverse Proxy for Apache v2 and IHS v2](#)".

31.5.3 Requirements for Apache v2 Web Servers

This discussion identifies specific requirements for Apache v2 with Access Manager.

Additional information can be found in your Apache documentation:

PATH Variable: On UNIX systems, your PATH variable must contain the gcc location before you compile Apache v2. However, the Sun C compiler location must not be in your PATH variable. On Windows systems, Apache can be built using either command-line tools or the Visual Studio IDE Workbench. The command-line build requires that the environment reflect the PATH, INCLUDE, LIB and other variables that can be configured with the vcvars32 batch file.

Multi-Process Module (MPM): With Apache v2, a default MPM is provided for each platform to bind network ports on the computer and to accept and process requests. Apache must have one, and only one, MPM in use at any time. If no MPM is selected during compilation, the default will be loaded into the Web server. You may activate the MPM during compilation.

mod_ssl: Access Manager supports Apache with or without SSL-capable communication. The base Apache Web server does not use SSL for browser connections and will not respond to HTTPS requests. For SSL-capable communication, Access Manager supports Apache with mod_ssl only. No SSL-specific Access Manager features operate with Apache-SSL.

mod_ssl relies on OpenSSL to provide the cryptography engine; mod_ssl provides an interface to the OpenSSL library. The OpenSSL library provides Strong Encryption using the Secure Sockets Layer and Transport Layer Security protocols.

With previous versions of Apache, the mod_ssl module had to be downloaded separately and compiled into the server. With Apache HTTP Server v2 module, mod_ssl comes as a loadable module that you can enable during configuration.

Multi-threading: Multi-threading is required for installations with Apache v1.3.27 or later.

Dynamic Shared Object (DSO): DSO support is required for Webgate. Apache modules that extend basic core server functionality may be either statically compiled for permanent inclusion in the Apache binary, or dynamically compiled and stored separately to load at runtime without recompiling. With Apache v1.3, mod_so had to be compiled. With Apache v2 on Windows systems, mod_so is a Base module and always included. With Apache v2 on UNIX, the loaded code typically comes from shared object files.

Note:

Dynamically loaded Apache 1.3 modules cannot be used directly with Apache v2. Apache v1.3 modules must be modified to load dynamically or compile into Apache v2.

mod_perl: mod_perl embeds the Perl programming language in the Apache Web server. Without Perl, Apache v2 can still be built and installed; however, some support scripts written in Perl cannot be used.

Note:

With Apache v.1.3.2x, some operating systems required additional options during configuration. However, to build Apache v2, there is no need to set any additional variables.

31.6 Preparing Your Web Server

The methods and steps to prepare your host computer for the Access Manager Web component installation depends on the specific Web server and platform.

To use reverse proxy functions with Access Manager, you need to include the proxy module in the configure command.

See "[About the Apache and IBM HTTP Reverse Proxy Server](#)".

See "[Activating Reverse Proxy for Apache v2 and IHS v2](#)".

Task Overview: Preparing your Web server and installing Access Manager

1. Install the IHS v2 Web server or compile and install the Apache v2 Web server as discussed in:
 - [Preparing the IHS v2 Web Server](#)
 - [Preparing Apache and Oracle HTTP Server Web Servers on Linux](#)
 - [Preparing Oracle HTTP Server Web Servers on Linux and Windows Platforms](#)
 - [Setting Oracle HTTP Server Client Certificates](#)
 - [Preparing the Apache v2 Web Server on UNIX](#)
 - [Preparing the Apache v2 SSL Web Server on AIX](#)
 - [Apache v2 Installation on Windows versus Installation on UNIX](#)
2. Activate reverse proxy capability if desired, as described in "[Activating Reverse Proxy for Apache v2 and IHS v2](#)".
3. Install Oracle Access Management, as described in *Oracle Fusion Middleware Installation Guide for Oracle Identity and Access Management*.
4. Finish Web server configuration, as described in "[Verifying httpd.conf Updates for Webgates](#)".
5. Refer to the following topics as needed:
 - "[Tuning Oracle HTTP Server Webgates for Access Manager](#)"
 - "[Tuning OHS / Apache Prefork and Worker MPM Modules for OAM](#)"
 - "[Tuning Apache/IHS v2 Webgates for Access Manager](#)"

Note:

In all the procedures that follow, path name variables, modules, and options are examples provided only to illustrate the steps. Your environment will vary. Refer to your Web server documentation for additional details.

31.6.1 Preparing the IHS v2 Web Server

To prepare your IHS v2 Web server to accept and use the Webgate for IHS v2, you need to complete one or more of the following procedures, depending on your environment and requirements:

- [Preparing the Host for IHS v2 Installation](#)
- [Installing the IBM HTTP Server v2](#)
- [Setting Up SSL-Capability](#)
- [Starting an IHS v2 Secure Virtual Host](#)
- [Activating Reverse Proxy for Apache v2 and IHS v2](#)

When you have completed the appropriate procedures, you are ready to install the Webgate for IHS v2.

31.6.1.1 Preparing the Host for IHS v2 Installation

You need to complete this procedure to set up the host computer before you can install the IHS Web server.

See [Requirements for IHS2 Web Servers](#).

See [Requirements for Apache v2 Web Servers](#).

This example illustrates installation on AIX 5.1. Your environment may vary.

To prepare for IHS v2 installation

1. On the host computer, download and install the IBM Developer Kit, Java Technology Edition version 1.4 from the following site:

<http://www.ibm.com/java/jdk>

The IBM Developer Kit ships with the WebSphere Application Server or can be downloaded from this site.

2. On the host computer, download and install the xlC.rte 6.0 runtime for AIX 5.1, which is required by the GSKit7 runtime executable from the following site:

<https://techsupport.services.ibm.com/server/aix.fdc>

3. On the host computer, create a new directory in which you will uncompress the IBM HTTP Server install image.

4. On the host computer, download the IBM HTTP Server install image from the following Web site:

<http://www-306.ibm.com/software/webservers/httpservers/>

5. On the host computer, uncompress the install image in your new directory.

For example:

```
tar -xf IHS.tar
```

A listing of the following files appears, based on your operating system:

```
gskit.sh
setup.jar
gskta.rte (a GSKit runtime executable for AIX)
```

You are ready to begin the installation, as described next.

6. Proceed to "[Installing the IBM HTTP Server v2](#)".

31.6.1.2 Installing the IBM HTTP Server v2

The procedure that follows walks you through a typical IBM HTTP Web server installation. Alternatively, you may choose to perform a silent installation.

In this case, you use silent.res file with the `java -jar setup.jar -silent -options silent.res` command. You can customize silent install options by editing the silent.res text file. All options are set to true by default. To disable an option, set its value to false.

To install the IBM HTTP Web server powered by Apache v2

1. Set your path to point to the Java Technology Edition version 1.4 installed on your computer in the previous example. For example:

```
export PATH=$PATH:/usr/java14/java/bin
```

2. From to the directory where you uncompress the install image, type the following command:

```
java -jar setup.jar
```

3. Choose the language in which to run the installation.

The Welcome to the InstallShield Wizard for the IBM HTTP Server appears.

4. Click Next to dismiss the Welcome screen.
5. Specify the directory name. For example:

```
AIX: /usr/IBMIHS/
```

6. Click Next to continue.

Options appear for a typical, custom, or developer installation. When you choose a typical installation, a list will appear with everything included and the size of the image. If you choose a custom installation, a list of components appears and you can clear the box next to the any components you do not want to install.

7. Select the type of installation you would like to perform, then click Next. For example:

```
Typical
```

The following message appears. You can click Cancel to stop the installation.

```
Installing IBM HTTP Server. Please wait.
```

The next message also appears. You can click Cancel to stop the inventory update.

Updating the inventory.

8. Click Finish to complete your installation.
9. Stop then start the IHS server using the apachectl commands, as follows:

For example:

```
IHS2_install_dir/bin
./apachectl stop
./apachectl start
```

where *IHS2_install_dir* is the directory where you installed the IHS v2 Web server.

You may configure the IHS v2 Web server in several modes either before or after installing the Webgate for IHS v2:

- [Setting Up SSL-Capability](#)
- [Starting an IHS v2 Secure Virtual Host](#)
- [Activating Reverse Proxy for Apache v2 and IHS v2](#)

31.6.1.3 Setting Up SSL-Capability

If you need to setup SSL-capability, use the following procedure either before or after installing the Webgate for IHS v2.

To set up SSL for IHS v2 using the default configuration file

1. Locate and open the following file:

```
IHS2_install_dir/conf/httpd.conf
```

2. Specify the SSLEnable directive to enable SSL.
3. Specify a Keyfile directive and any SSL directives you want to enable.
4. Stop then start the IHS server, as follows. For example:

```
IHS2_install_dir/bin
./apachectl stop
./apachectl start
```

where *IHS2_install_dir* is the directory where you installed the IHS v2 Web server.

5. Continue with the following procedures:
 - [Starting an IHS v2 Secure Virtual Host](#)
 - [Activating Reverse Proxy for Apache v2 and IHS v2](#)

31.6.1.4 Starting an IHS v2 Secure Virtual Host

If you need to start a secure virtual host, use the following procedure either before or after installing the Webgate for IHS v2.

To start an IHS v2 secure virtual host

1. Locate and open the following file:

```
IHS2_install_dir/conf/httpd.conf
```

where *IHS2_install_dir* is the directory where you installed the IHS v2 Web server.

2. Specify the `SSLEnable` directive in the virtual host stanza of the configuration file, to enable SSL for a virtual host.

You can specify any directive, with the exception of the cache directives, inside a virtual host.

3. Specify a `Keyfile` directive and any SSL directives you want to enable for that particular virtual host.
4. Load the `mod_ibm_ssl.so` using the `LoadModule` directive in the conf file.
5. Stop then start the IHS virtual host, as follows. For example:

```
IHS2_install_dir/bin
./apachectl stop
./apachectl start
```

Note:

The start and stop instructions for an SSL implementation are the same as non-SSL-capable implementations.

6. Continue with [Activating Reverse Proxy for Apache v2 and IHS v2](#).

31.6.2 Preparing Apache and Oracle HTTP Server Web Servers on Linux

When installing Webgates for Apache or Oracle HTTP Server on Linux, you are prompted to install as the same user under which the Web server is running.

See the User and Group directive entries in the `httpd.conf` file.

When installing Access Manager Webgates for vendor-bundled Apache v2 on Red Hat Enterprise Linux 4, ensure that all Webgates are installed for Web server user & group (default: `apache`).

See "[Tuning Apache/IHS v2 Webgates for Access Manager](#)".

Note:

On Linux, Webgates for Oracle HTTP Server 11g use only NPTL; you cannot use the `LinuxThreads` library. In this case, do not set the environment variable `LD_ASSUME_KERNEL` to 2.4.19.

31.6.3 Preparing Oracle HTTP Server Web Servers on Linux and Windows Platforms

When using Webgates for Oracle HTTP Server v2 on Windows and Linux platforms, both the Perl module and the PHP module must be commented out in the `httpd.conf`.

Note:

With Oracle HTTP Server 11g, there is no need to comment out any module for Webgates on any platform.

31.6.4 Setting Oracle HTTP Server Client Certificates

When using `cert_decode` and `credential_mapping` authentication modules, you must ensure that the Client Certificate authentication scheme works properly with SSL-enabled Oracle HTTP Server by adding `+EarlierEnvVars` and `+ExportCertData` to the existing SSL options in the Oracle HTTP Server Web server configuration file.

For example:

credential_mapping:

```
obMappingBase="o=company,c=us",obMappingFilter=
"(&(objectclass=InetOrgPerson)(mail=%certSubject.E%))"
```

ssl.conf must include:

```
SSLOptions +StdEnvVars +ExportCertData +EarlierEnvVars
```

To add ssl options to Oracle HTTP Server

1. Locate and open the Oracle HTTP Server Web server configuration file with a text editor. For example:

```
$ORACLE_INSTANCE/ohs/conf/ssl.conf
```

2. In the `ssl.conf` file, add the following information to existing SSL options. For example:

```
SSLOptions +StdEnvVars +ExportCertData +EarlierEnvVars
```

3. Save the file and restart the Web server.

31.6.5 Preparing the Apache v2 Web Server on UNIX

This discussion provides an overview and steps to prepare the Apache v2 HTTP Web server for Access Manager on UNIX platforms, including Solaris, UNIX, Linux, and AIX.

See also "[Preparing the Apache v2 SSL Web Server on AIX](#)"

Apache v2 can be configured, built, and installed plain or as SSL-capable. After downloading and extracting Apache source files, you use a script (configure script on UNIX and the `makefile.win` make script for Windows) to compile the source tree for your environment.

Note:

Basic requirements are the same regardless of your platform. However, the remainder of this discussion and the procedures that follow focus on UNIX platforms. For more information, see also "[Preparing the Apache v2 SSL Web Server on AIX](#)".

When you configure Apache v2 on UNIX platforms, you specify the installation directory path name using the `-prefix=` option with the `./configure` command. During configuration you enable the modules that are appropriate for your environment. For example, `mod_so` is included in the server automatically when dynamic modules are included in the compilation. However, you can ensure the server is capable of loading DSOs by including the `-enable-so` option with the

configure command. If you have multiple Perl interpreters installed, you can include the `-with-perl` option to ensure the correct interpreter is selected during configuration.

In the configure command, you can also include the options to enable `mod_ssl`, and to activate an MPM. After configuration, you can verify which MPM was chosen using `./httpd -l` to list every module that is compiled into the server.

When you finish configuring Apache, you build the various parts that form the Apache package using the make command then install the package under the installation directory you specified with the `-prefix=` option during configuration.

For steps and examples, see the following procedures and your Apache documentation:

- [Preparing plain Apache v2 for UNIX](#)
- [Preparing SSL-capable Apache v2 on UNIX](#)
- [Preparing Apache v2 for Windows](#)
- [Activating Reverse Proxy for Apache v2 and IHS v2](#)

In the procedures that follow, path name variables, modules, and options are examples provided only to illustrate the steps. Your environment will vary. Refer to your Web server documentation for additional details. There is no difference in the build procedure between Apache v2.0.48 and v2.0.52.

31.6.5.1 Preparing plain Apache v2 for UNIX

You can prepare the plain Apache v2 Web Server for Unix.

1. Confirm that your environment meets Apache requirements for the appropriate compiler and build tools, as described in Apache documentation located at:

<http://httpd.apache.org/docs-2.0/install.html#requirements>

Note:

There are no known restrictions with regard to supported compiler versions for Apache v2 and Access Manager plug-ins. See the Apache documentation.

2. Download a complete, unmodified version of the Apache HTTP Server v2, as described in the Apache documentation. For example:

<http://httpd.apache.org/download.cgi>

Note:

Be sure to download Perl, if needed.

3. Extract (uncompress, then untar) source files from the tarball, as described in the Apache documentation. For example:

```
gzip -d httpd-2_0_48.tar.gz
tar -xvf httpd-2_0_48.tar
```

You can use the following step as an example of configuring the Apache source tree. If you compile Apache on UNIX with the `mpm_worker_module` for Webgate, see "[Apache v2 on UNIX with the mpm_worker_module for Webgate](#)".

Note:

To use reverse proxy functions with Access Manager, you need to include the proxy module in the configure command, as discussed in "[About the Apache and IBM HTTP Reverse Proxy Server](#)".

4. Ensure that you have the correct version of GNU gcc libraries in the proper path to build the Apache source; gcc libraries should be in the PATH:

```
export PATH=/usr/local/packages/gcc-3.4.6/bin:$PATH
```

5. Configure the Apache source tree and enable or activate the desired modules using details in the Apache documentation. For example:

```
cd apache_source_dir
./configure --with-mpm=prefork --prefix=apache_install_dir --with-included-apr
./configure --with-mpm=worker --prefix=apache_install_dir --with-included-apr
```

where *apache_source_dir* refers to the directory where you extracted Apache and *apache_install_dir* refers to the directory where you want to install Apache.

6. Compile the Apache package you configured using the make command. For example:

```
make
```

7. Install the Apache package in the configured directory path that you specified earlier using the `--prefix=` option. For example:

```
make install
```

8. Customize the installation using instructions in the Apache documentation.

For example, you may need to tune the `httpd.conf` to set basic values for:

```
ServerName
User/owner of the WebServer
Group
```

Note:

To view the complete list of values, use the command: `./configure --help`.

9. Stop then restart the Apache Web server to test the installation using commands in the *apache_install_dir/bin* directory. For example:

```
./apachectl stop
./apachectl start
```

10. Continue with appropriate tasks for your environment, as follows:

- [Preparing SSL-capable Apache v2 on UNIX](#)
- [Preparing the Apache v2 Web Server on UNIX](#)

- [Activating Reverse Proxy for Apache v2 and IHS v2](#)

The following procedure outlines how to prepare an SSL-capable Apache v2 Web server on UNIX. The Apache `mod_ssl` is loadable; however, this installation requires the Open Source toolkit for SSL/TLS. Again, be sure to download Perl, if needed. If AIX is the platform you are using, be sure to see "[Preparing the Apache v2 SSL Web Server on AIX](#)" for additional information.

31.6.5.2 Preparing SSL-capable Apache v2 on UNIX

The following steps provides instructions on how to prepare the SSL-capable Apache v2 Web Server for Unix

1. Confirm that your environment meets Apache requirements for the appropriate compiler and build tools, as described in Apache documentation located at:

<http://httpd.apache.org/docs-2.0/install.html>

2. Download a complete, unmodified version of the Apache HTTP Server v2 and Open Source, as described in the Apache documentation.

<http://httpd.apache.org/download.cgi>

<http://www.openssl.org/>

3. Extract (uncompress, then untar) source files from the tarballs, as described in the Apache documentation. For example:

```
gzip -d httpd-2_0_48.tar.gz
tar -xvf httpd-2_0_48.tar
gzip -d openssl-0_9_6f.tar.gz
tar -xvf openssl-0_9_6f.tar
```

4. Configure the OpenSSL source tree, as described in Apache documentation. For example:

```
cd openssl_source_dir
./config -fPIC --prefix=openssl_install_dir
```

where *openssl_source_dir* refers to the directory where you extracted OpenSSL and *openssl_install_dir* refers to the directory where you want to install the configured OpenSSL package.

5. Compile the OpenSSL package in the installation directory you configured using the `make` command with the `--prefix=` option. For example:

```
make
```

6. Issue the `make test` command to complete any sanity testing of OpenSSL and check the correct version of the tools required. For example:

```
make test
```

7. Install the OpenSSL package in the configured directory path that you specified earlier using the `--prefix=` option. For example:

```
make install
```

8. Configure the Apache source tree and enable or activate desired modules, as described in your Apache documentation. For example:

```
cd apache_source_dir ./configure --prefix=apache_install_dir
--enable-so \ --with-mpm='prefork' --with-perl=perl_interpreter_path \
--with-port=non_ssl_port --enable-ssl \ --with-ssl=openssl_install_dir
```

where *apache_source_dir* refers to the directory where you extracted Apache; *apache_install_dir* refers to the directory where you want to install Apache; and *openssl_install_dir* refers to the directory where you installed the configured OpenSSL package.

9. Compile using the make command to build the Apache SSL-capable package in the installation directory you configured using the `--prefix=` option. For example:

```
make install
```

10. Install the Apache SSL-capable package in the configured directory path that you specified earlier using the `--prefix=` option. For example:

```
make install
```

You must explicitly make certificates for the Apache v2 server to enable SSL using the openssl tool located at *openssl_install_dir/bin/*. The make certificate command does not work with Apache v2.

11. Make certificates using the OpenSSL tool in the *openssl_install_dir/bin* directory, as described in your OpenSSL documentation and remember that "Common Name" is the fully qualified host name.

12. Customize the installation using instructions in the Apache documentation:

- Tune the `httpd.conf` to set basic values for:

```
ServerName
User/owner of the WebServer
`Group
```

- Tune the `ssl.conf` to set basic values for:

```
Listen 7000
<VirtualHost _default_:7000>
ServerName ps0733.persistent.co.in:7000
SSLCertificateFile /home/qa/software/ws/apache/
apache-2.0.48_ssl_7000/conf/ssl.crt/server.crt
SSLCertificateKeyFile /home/qa/software/ws/apache/
apache-2.0.48_ssl_7000/conf/ssl.key/server.key
```

13. Stop then restart the Apache Web server to test the installation using commands in the *apache_install_dir/bin* directory. For example:

```
./apachectl stop
./apachectl startssl
```

14. Continue with [Activating Reverse Proxy for Apache v2 and IHS v2](#), if needed.

31.6.6 Preparing the Apache v2 SSL Web Server on AIX

While building the Apache v2 SSL Web server, the symbols from the OpenSSL Library `libssl.a` are exported into the `httpd` executable in Apache.

The symbols needed by Access Manager from the OpenSSL library are:

- `SSL_get_peer_certificate()`

- `i2d_X509()`

During linking and binding on the AIX platform, any unused or unreferenced symbols are deleted. Therefore, the two symbols required by Access Manager are missing from the `httpd` executable.

You need to use `openssl-0.9.7d` to compile on AIX (`openssl-0.9.7e` does not compile on AIX). The rest of the steps are the same as on UNIX `openssl-0.9.7d`.

Client Cert Authentication: If you are using Client Cert Authentication on the AIX platform, be sure to use AIX 5.2 Maintenance Level 4 with the following hot fix applied for `dlsym` problem on AIX:

<http://www-1.ibm.com/support/docview.wss?uid=isg1IY63366>

To prepare the AIX platform for Apache v2

1. Ensure that your AIX platform meets the system requirements for Access Manager.
2. See details in "[Preparing the Apache v2 Web Server on UNIX](#)" and when building the Apache v2 Web server:
 - Use `openssl-0.9.7d` to compile the Web server for AIX.
 - Use the `make` command in the following manner:

```
make MFLAGS=EXTRA_LDFLAGS=' -Wl, -bE:OpenSSL_Symbols.exp'
```

where `OpenSSL_Symbols.exp` is the file containing the two required symbols. The symbol must be exported using the export file only, as shown.

Note:

Do not export the symbol on AIX with the following methods: `-bnog`: To suppress garbage collection of symbols `-bexpal`: To export all symbols `-uSymbolName`: To export a particular symbol.

31.6.7 Apache v2 Installation on Windows versus Installation on UNIX

Following are some details about how installing and configuring Apache v2 on Windows differs from Apache v2 on UNIX.

For more information, see your Apache documentation.

During Installation: Apache configures files in the `\conf` subdirectory to reflect the chosen installation directory. If any configuration files in this directory already exist, a new copy of the corresponding file is then written with the extension `.ORIG`. For example, `\conf\httpd.conf.ORIG`.

After Installation: Apache is configured using the files in the `\conf` subdirectory. These are the same files used to configure the UNIX version. However, there are a few differences.

You must edit the configuration files in the `\conf` subdirectory to customize Apache for your environment. These files will be configured during the installation; Apache is ready to run from the installation directory, with the documents server from the subdirectory `htdocs`. There are many options you should set before starting to use Apache. For example, Apache listens on port 80 unless you change the `Listen` directive in the configuration files or install Apache only for the current user.

Multi-Threading: Apache for Windows is multi-threaded, which means that it does not use a separate process for each request as Apache does on UNIX. Instead there are usually only two Apache processes running: a parent process, and a child which handles the requests. Within the child process each request is handled by a separate thread.

UNIX-Style Names: Apache uses UNIX-style names internally. The directives that accept filenames as arguments must use Windows filenames instead of UNIX filenames. However, you must use forward slashes, not back slashes. Drive letters may be used. However, if a drive letter is omitted, the drive with the Apache executable is assumed.

LoadModule Directive: Apache for Windows includes the ability to load modules at runtime without recompiling the server. If Apache is compiled normally, it will install a number of optional modules in the \Apache2\modules directory. To activate these or other modules, you must use the LoadModule directive. For example, to activate the status module, use the following (in addition to the status-activating directives in access.conf):

```
LoadModule status_module modules/mod_status.so
```

On UNIX, the loaded code typically comes from shared object files (.so extension), on Windows this may be either the .so or .dll extension.

Process Management Directives: These directives are also different for Apache on Windows.

Error Logging: During Apache startup, any errors are logged into the Windows event log, which provides a backup to the error.log file. For more information, see your Apache documentation.

Apache Service Monitor: Apache comes with an Apache Service Monitor utility. With it you can see and manage the state of all installed Apache services on any computer on your network. To manage an Apache service with the monitor, you must first install the service. Apache may be run as a service on Windows. For details, see your Apache documentation.

Starting, Restarting, Shutting Down: Running Apache as a service is the recommended method. An Apache service is typically started, restarted, and shut down using the Apache Service Monitor and commands like NET START Apache2 and NET STOP Apache2. You may also use standard Windows service management.

You may work with Apache from the command line using the apache command. Apache will execute and remain running until it is stopped by pressing Control-C. You may also run Apache from the Start Menu during installation.

Note:

Pressing Control-C may not allow Apache to end any current operations and clean up gracefully.

Apache Services Accounts: By default, all Apache services are registered to run as the system user (the LocalSystem account). The LocalSystem account has no network privileges through any Windows-secured mechanism. However, the LocalSystem account has wide privileges locally. For details about creating a separate account to run one or more Apache services, see your Apache documentation.

31.6.8 Preparing Apache v2 for Windows

The following section provides instructions on preparing Apache v2 Web Server for Windows.

1. Confirm that your environment meets Apache requirements, as described in Apache documentation located at:

<http://httpd.apache.org/docs-2.0/install.html>

For Windows installations a list of HTTP and FTP mirrors from which you can download Apache v2 is provided online.

When you complete the next step, be sure to download the version of Apache for Windows with the .msi extension.

2. Download a complete, unmodified version of the Apache HTTP Server v2 (and OpenSSL), as described in the Apache documentation. For example:

<http://httpd.apache.org/download.cgi>

<http://www.openssl.org/>

3. Install Apache v2 (run the .msi file you downloaded and supply requested information), using your Apache documentation as a guide.
4. Locate the .default.conf file, verify new settings, then update your existing configuration file if needed.
5. Start Apache, either in a console window or as a service.
6. Launch a browser and enter the following URL to connect to the server and access the default page.

For example:

`http://localhost/`

A welcome page and a link to the Apache manual should appear. If not, look in the error.log file in the logs subdirectory.

Once your basic installation is working, you need to configure it properly by editing the files in the \conf subdirectory.

7. Configure the Apache installation for your environment, using the Apache documentation as a guide.
8. Test your customized environment.
9. Continue with [Activating Reverse Proxy for Apache v2 and IHS v2](#), if needed.

31.7 Activating Reverse Proxy for Apache v2 and IHS v2

The Webgates for Apache v2 and IHS v2 powered by Apache support reverse proxy capability, if you choose to activate this capability.

The procedures to implement reverse proxy capability differ, depending on your environment:

- [Activating Reverse Proxy For Apache v2 Web Servers](#)

- [Activating Reverse Proxy For IHS v2 Web Servers](#)

31.7.1 Activating Reverse Proxy For Apache v2 Web Servers

For reverse proxy functions with Access Manager, you need to include the Apache proxy module in the configure command for the Web server. You also need to load mod_proxy and the mod_proxy_http module into the server dynamically. A reverse proxy is activated using the ProxyPass directive or the [P] flag to the RewriteRule directive.

Reverse proxy capability is activated using the ProxyPass directive or the [P] flag to the RewriteRule directive. It is not necessary to turn ProxyRequests on to configure a reverse proxy. Access control is less critical when using a reverse proxy (ProxyPass directive with ProxyRequests Off), because clients can contact only the hosts that you have specifically configured. You can control access to your proxy using the <Proxy> control block.

To activate reverse proxy capability for Apache v2 Web servers

1. Review the following topics:

See "[About the Apache and IBM HTTP Reverse Proxy Server](#)".

2. Include the Apache proxy module in the configure command for the Web server, if needed.

For example:

```
--enable-proxy
--enable-proxy-connect
--enable-proxy-ftp
--enable-proxy-http
```

See the Apache documentation for more information.

3. Use the ProxyPass directive or the [P] flag to the RewriteRule directive to activate a reverse proxy, as follows:

```
Reverse Proxy
ProxyRequests Off
<Proxy *>
  Order deny,allow
  Allow from all
</Proxy>
ProxyPass /foo http://foo.example.com/bar
ProxyPassReverse /foo http://foo.example.com/bar
```

4. Control access to your proxy using the <Proxy> control block as follows:

```
<Proxy *>
  Order Deny,Allow
  Deny from all
  Allow from 192.168.0
</Proxy>
```

5. Perform steps in [Registering and Managing 10g WebGates with Access Manager 11g](#), if you haven't yet done so.

31.7.2 Activating Reverse Proxy For IHS v2 Web Servers

Use the following procedure after installing the Web server.

To activate reverse proxy capability for IHS v2 Web servers

1. Review "[About the Apache and IBM HTTP Reverse Proxy Server](#)"
2. Install the IHS v2 Web server, as described in "[Preparing the IHS v2 Web Server](#)".
3. Load the modules by including these lines (uncommented) in the Dynamic Shared Object section of the httpd.conf file in:

IHS_install_dir/conf/httpd.conf

```
LoadModule access_module modules/mod_access.so
LoadModule auth_module modules/mod_auth.so
LoadModule auth_dbm_module modules/mod_auth_dbm.so
LoadModule include_module modules/mod_include.so
LoadModule log_config_module modules/mod_log_config.so
LoadModule env_module modules/mod_env.so
LoadModule unique_id_module modules/mod_unique_id.so
LoadModule setenvif_module modules/mod_setenvif.so
LoadModule proxy_module modules/mod_proxy.so
LoadModule proxy_connect_module modules/mod_proxy_connect.so
LoadModule proxy_ftp_module modules/mod_proxy_ftp.so
LoadModule proxy_http_module modules/mod_proxy_http.so
LoadModule mime_module modules/mod_mime.so
LoadModule dav_module modules/mod_dav.so
LoadModule autoindex_module modules/mod_autoindex.so
LoadModule asis_module modules/mod_asis.so
LoadModule info_module modules/mod_info.so
LoadModule cgid_module modules/mod_cgid.so
LoadModule dav_fs_module modules/mod_dav_fs.so
LoadModule vhost_alias_module modules/mod_vhost_alias.so
LoadModule dir_module modules/mod_dir.so
LoadModule imap_module modules/mod_imap.so
LoadModule actions_module modules/mod_actions.so
LoadModule userdir_module modules/mod_userdir.so
LoadModule alias_module modules/mod_alias.so
LoadModule rewrite_module modules/mod_rewrite.so
```

4. Directives Under the IfModule mod_proxy.c Tag--Use the information and the following examples to ensure that:

- Allow or Deny conditions are appropriately commented.

For example:

```
<Proxy *>
    Order deny, allow
#   Deny from all
    Allow from all
#   Allow from .domain.com
</Proxy>
```

- URLs to be protected are mentioned in both the ProxyPass and the ProxyPassReverse directives.

For example:

```
<IfModule mod_proxy.c>
ProxyRequests Off
ProxyPass /testproxy http://bedford: 8809/testrev/
ProxyPassReverse /testproxy http://bedford: 8809/testrev/
ProxyPass /test2 http://bedford: 8809/testrev/
ProxyPassReverse /test2 http://bedford: 8809/testrev/
```

- Restart the Web server after any modifications to the httpd.conf file.
- Testing:** To access the proxy URL, access `http://<proxy_host>:80/testproxy/`

Note:

While testing, make sure the URLs have a trailing forward slash. Sometimes resources cannot be accessed without the forward slash at the end.

- Enabling SSL on Reverse Proxy Server: Use the documentation on the IHS default page.

For example, sample SSL settings in the DSO section of the httpd.conf file load the `ibm_ssl_module` as:

```
LoadModule ibm_ssl_module modules/mod_ibm_ssl.so
```

- Include the following directives in your httpd.conf file:

```
SSLEnable
Keyfile /opt/IBMIHS/bin/key.kdb
SSLClientAuth none
SSLProxyEngine on
```

- Restart server.
- Access the Web server URL and confirm that the browser is presented with a certificate.

Note:

You can switch back to open mode for the Web server simply by commenting out the preceding directives and restarting the server.

- key.kdb:** To generate the `key.kdb`, use the `keyman` utility (preferably in GUI mode) provided in the `IHS_install_dir/bin` directory.

Note:

The `keyman` utility uses the `gsk7bas` utility. However, you need to apply fix pack PQ83048 on `gsk7bas`.

- Perform the following steps:
 - Complete 10g Webgate installation with Access Manager 11g as described in [Registering and Managing 10g WebGates with Access Manager 11g](#), if you haven't yet done so
 - Return to this chapter to perform remaining tasks in this chapter as needed.

31.8 Verifying httpd.conf Updates for Webgates

It is a good idea to complete the following procedures to ensure that the Apache or IHS v2 httpd.conf file includes Web server configuration updates for Access Manager.

For details, see:

- [Verifying Webgate Details](#)
- [Verifying Language Encoding](#)

To update httpd.conf for reverse proxy on IHS Web servers, see "[Activating Reverse Proxy For IHS v2 Web Servers](#)". To customize httpd.conf for your Web server, see your Web server documentation.

31.8.1 Verifying Webgate Details

The example that follows shows the Webgate section in the httpd.conf file. The details will vary, depending on your environment.

This example is provided only to illustrate the type of changes you will see in httpd.conf.

To verify the Webgate section in httpd.conf

1. Locate the updated httpd.conf file on the computer hosting the Webgate.
2. Open the httpd.conf file and ensure that the section that loads the Webgate in your platform is present.

For example:

On Windows

```
**** BEGIN Oblix NetPoint Webgate Specific ****
<IfModule mod_ssl.c>
LoadModule obWebgateModule "WebGate_install_dir\access\oblix\apps\webgate\bin
\webgatessl.dll"
    WebGateInstallDir "WebGate_install_dir"
    WebGateMode PEER
</IfModule>
<IfModule !mod_ssl.c>
LoadModule obWebgateModule "WebGate_install_dir\access\oblix\apps\webgate\bin
\webgate.dll"
    WebGateInstallDir "WebGate_install_dir"
    WebGateMode PEER
</IfModule>
<Location "\oberr.cgi">
SetHandler obwebgateerr
</Location>
<LocationMatch "/*">
AuthType Oblix
require valid-user
</LocationMatch>
**** END Oblix NetPoint Webgate Specific ****
```

On UNIX

```
**** BEGIN Oblix NetPoint Webgate Specific ****
LoadFile "/home/qa/netpoint/703/cl-copy/wg/access/oblix/lib/libgcc_s.so.1"
LoadFile "/home/qa/netpoint/703/cl-copy/wg/access/oblix/lib/libstdc++.so.5"
<IfModule mod_ssl.c>
    LoadModule obWebgateModule "/home/qa/netpoint/703/cl-copy/wg/access/oblix/
apps/webgate/bin/webgatessl.so"
</IfModule>
<IfModule !mod_ssl.c>
    LoadModule obWebgateModule "/home/qa/netpoint/703/cl-copy/wg/access/oblix/
apps/webgate/bin/webgate.so"
```



```

</IfModule>
WebGateInstallDir "/home/qa/netpoint/703/cl-copy/wg/access"
WebGateMode PEER
<Location /access/oblix/apps/webgate/bin/webgate.cgi>
SetHandler obwebgateerr
</Location>
<Location "/oberr.cgi">
SetHandler obwebgateerr
</Location>
<LocationMatch "/*">
AuthType Oblix
require valid-user
</LocationMatch>
**** END Oblix NetPoint Webgate Specific ****

```

Notes for UNIX

When running Apache v2 on HP-UX, do not use nobody for User or Group, because shared memory may not work. Instead, use your login name as User Name with a group Group as "Oblix" (or "www" as User Name and "others" as Group Name). On HP-UX, "www" is equivalent to "nobody" on Solaris.

When running Apache v2 on HPUX 11.11, ensure that the AcceptMutex directive in the Apache httpd.conf file is set to "fcntl". If the directive is not present, add it to the httpd.conf file (AcceptMutex fcntl). For more information, see http://issues.apache.org/bugzilla/show_bug.cgi?id=22484).

Notes for IHS on AIX

```

**** BEGIN Oblix NetPoint Webgate Specific ****
LoadModule obWebgateModule DR/oblix/apps/webgate/bin/webgate.so
WebGateInstallDir DR
WebGateMode PEER
<Location "/oberr.cgi">
    SetHandler obwebgateerr
</Location>
<LocationMatch "/*">
    AuthType Oblix
    require valid-user
</LocationMatch>
**** END Oblix NetPoint Webgate Specific ****

```

1. Use the `chmod -r username:groupname directory/file` to change the User Name and Group Name of a directory or a file.

When you do this, you need to change the User and Group parameters in the httpd.conf file accordingly.

2. Complete any additional steps needed to finish the Access Manager implementation for Apache v2.

See [Tuning Apache/IHS v2 Webgates for Access Manager](#).

Note:

YYou use the following procedure only if you need to clear the httpd.conf file of Webgate-related changes, then complete the Apache v2 Web server configuration for the Webgate anew.

31.8.1.1 Starting httpd.conf updates anew

To start the httpd.conf updates newly, you can restore or update the file.

1. Restore the original httpd.conf file to remove any Access Manager entries that are present.
2. Update the httpd.conf file for Access Manager using one of the following methods:
 - **Either** open the file *component_install_dir/access/oblix/lang/LangTag/docs/config.htm* and perform a manual configuration.
See [Registering and Managing 10g WebGates with Access Manager 11g](#).
 - **Or** launch the ManageHttpConf program in *component_install_dir/access/oblix/tools/setup/InstallTools/ManageHttpConf* without any options to print instructions on its use.

Note:

If the ManageHttpConf program is run with Webgate entries already present in the httpd.conf file, an error message will be printed and the httpd.conf file will not be updated.

3. Complete activities in "[Tuning Apache/IHS v2 Webgates for Access Manager](#)".

31.8.2 Verifying Language Encoding

You can ensure proper language encoding by setting the directives in the httpd.conf file.

The Access Manager HTML pages use UTF-8 encoding. Apache-based Web servers allow Administrators to specify a default character set for all HTML pages sent out using the `AddDefaultCharset` directive, which overrides any character specified by the application generating the HTML pages. If the `AddDefaultCharset` directive enables a character set other than UTF-8, Access Manager HTML pages are garbled.

To ensure proper language encoding

1. Open the httpd.conf file.
2. Locate the `AddDefaultCharset` directive.
3. Complete one of the following activities to ensure that proper encoding of Access Manager HTML pages:
 - Either set the `AddDefaultCharset` directive to `Off`.
 - Or Comment out the `AddDefaultCharset` directive.
4. Save the httpd.conf file and restart the Web server.

31.9 Tuning Oracle HTTP Server Webgates for Access Manager

After installing the Access Manager Web component for Oracle HTTP Server, you need to complete the steps that follow.

As mentioned earlier, before installing Webgates for Oracle HTTP Server, in the `httpd.conf` file you must change the user and group to match the user that is installing the component.

Note:

On Linux, Webgates for Oracle HTTP Server 11g use only NPTL; you cannot use the LinuxThreads library. In this case, do not set the environment variable `LD_ASSUME_KERNEL` to 2.4.19.

To tune Oracle HTTP Server for Webgates

1. Shut down `opmn`, as you usually do.
2. Locate and open the `opmn.xml` file for editing. For example:

```
$ORACLE_HOME/opmn/bin/opmn.xml
```

3. In the `opmn.xml` file, adjust items as follows:

```
<ias-component id="HTTP_Server">
<process-type id="HTTP_Server" module-id="OHS2">
  <environment>
    <variable id="TMP" value="/tmp"/>
    <variable id="LD_ASSUME_KERNEL" value="2.4.19"/>
  </environment>
  <module-data>
    <category id="start-parameters">
      <data id="start-mode" value="ssl-disabled"/>
    </category>
  </module-data>
  <process-set id="HTTP_Server" numprocs="1"/>
</process-type>
</ias-component>
```

4. Refresh the OPMN configuration by executing the following script:

```
#ORACLE_HOME/opmn/bin/opmnctl reload
```

5. Start the Oracle HTTP Server Web server, as described in "[Starting and Stopping Oracle HTTP Server Web Servers](#)"

31.10 Tuning OHS /Apache Prefork and Worker MPM Modules for OAM

Oracle recommends specific tuning parameters with Webgates for these Web servers.

The tuning parameters described in this section are configured in the `httpd.conf` file with Apache v2.0 and OHS11g. For Apache v2.2, however, tuning is configured in the following files:

- `apache_install_dir/conf/extra/httpd-mpm.conf`
- `apache_install_dir/conf/extra/httpd-default.conf`

Also for Apache v2.2, the entries for `httpd-mpm.conf` and `httpd-default.conf` should be uncommented, as follows:

From:

```
#Include conf/extra/httpd-mpm.conf
#Include conf/extra/httpd-default.conf
```

To:

```
Include conf/extra/httpd-mpm.conf
Include conf/extra/httpd-default.conf
```

Use the following topics as needed for your environment:

- [Oracle HTTP Server / Apache Prefork MPM Module Parameters](#)
- [Oracle HTTP Server / Apache Worker MPM Module Parameters](#)
- [Kernel Parameters](#)

31.10.1 Oracle HTTP Server /Apache Prefork MPM Module Parameters

When using Access Manager with either the Oracle HTTP Server or Apache Prefork MPM module, Oracle recommends the following as broad guidelines.

- Timeout 300
- KeepAlive On
- MaxKeepAliveRequests 500
- KeepAliveTimeout 10
- StartServers: 5 (Initial number of processes to start; used only on startup.)
- MaxClients: 500 (Total number of processes to handle load at peak time. Determines how many child processes will be created to handle requests at peak period.)
- ServerLimit: 500 (The maximum configured value for MaxClients for the lifetime of the process. If MaxClients is set to a value higher than the default, ServerLimit value should be specified above the rest of the parameters.)
- MinSpareServers, MaxSpareServers: Default values should suffice requirements to handle a heavy load. During operation, these values regulate how the parent process creates children to serve requests.
- MaxRequestsPerChild: 0 - Number of requests sent to each child process. 0 indicates the process never expires/dies

31.10.2 Oracle HTTP Server /Apache Worker MPM Module Parameters

When using Access Manager with either the Oracle HTTP Server or the Apache Worker MPM module, Oracle recommends the following as broad guidelines.

- Timeout 300
- KeepAlive On
- MaxKeepAliveRequests 500
- KeepAliveTimeout 10
- StartServers: 2 (Initial number of processes to start; used only on startup.)

- **MaxClients:** 500 (Total number of processes to handle load at peak time. Determines how many child processes will be created to handle requests at peak period.)
- **ServerLimit:** 25 (The maximum configured value for MaxClients for the lifetime of the process. If MaxClients is set to a value higher than the default, ServerLimit value should be specified above the rest of the parameters.)
- **MinSpareServers, MaxSpareServers:** 25, 75. During operation, these values regulate how the parent process creates children to serve requests.
- **ThreadsPerChild:** 25 (The number of worker threads in single httpd process.)
- **MaxRequestsPerChild:** 0 (This directive sets the limit on the number of requests that an individual child server process will handle. The value 0 will ensure that the process never expires.)

31.10.3 Kernel Parameters

Oracle recommends that you ensure the kernel parameters for the soft and hard limit on the file descriptors are set to a high value.

For example:

Hard limit (rlim_fd_max): 65535

Soft limit (rlim_fd_cur): 65535

The high value of the file descriptor is a strong recommendation for the Apache server that will open and close sockets for requests.

31.11 Starting and Stopping Oracle HTTP Server Web Servers

Starting and stopping an Oracle HTTP Server Web server is the same procedure for both v1.3 and v2, on all platforms.

To start the Oracle HTTP Server Web server

1. Locate and change to the following directory:
`$ORACLE_HOME\opmn\bin\`
2. From the command line, enter the following command:

```
opmnctl/startproc process-type=HTTP_Server
```

To stop the Oracle HTTP Server Web server

1. Locate and change to the following directory:
`$ORACLE_HOME\opmn\bin\`
2. From the command line, enter the following command:

```
opmnctl/stopproc process-type=HTTP_Server
```

31.12 Tuning Apache/IHS v2 Webgates for Access Manager

Unless explicitly stated, information here applies to both Apache and IHS v2 Webgate (also known as plug-ins).

For details about Oracle HTTP Server, see the *Oracle HTTP Server Administrator's Guide 10g R2 (10.1.2)*.

- [About Apache v2 bundled with Security-Enhanced Linux](#)
- [About Apache v2 bundled SELinux-enabled Linux Distribution](#)
- [Apache v2 Directives](#)

31.12.1 About Apache v2 bundled with Security-Enhanced Linux

With SELinux, errors could be reported in WebServer logs/console when starting a Web server on Linux distributions that have more strict SELinux policies in place after installing an Access Manager Webgate.

You can avoid these errors by running appropriate `chcon` commands for the installed Web component before restarting the Web server.

See Also:

["SELinux Issues"](#)

31.12.2 About Apache v2 bundled SELinux-enabled Linux Distribution

Security-enhanced Linux (SELinux) is an automatically enabled implementation of a mandatory access-control mechanism.

As described in your Linux documentation, SELinux policies provide access to certain pre-defined system directories such as `/etc/httpd/conf`, `/usr/sbin/apachectl`, and `/var/log/` (to name a few) for system daemons.

When Webgates are installed with the bundled Apache Web server, certain policies must be added to allow Apache processes to access installation files.

The bundled Apache Web server runs as user "apache" with a security context defined as `context=user_u:system_r:unconfined_t`. As a result, when Webgates are installed in any of the user folders, the Apache Web server will not start.

The `$SELINUX_SRC` variable represents the SELinux policy source directory. The default value is `/etc/selinux/targeted/src/policy`. However, your environment may vary. Be sure to consult your system Administrator for the actual value for your system.

31.12.2.1 Adding Access Manager Policies to Apache bundled with Red Hat Enterprise Linux 4

You can add Access Manager policies to Apache bundles with Red Hat Enterprise Linux 4.

1. After installing each Access Manager Webgate, log in as the 'root' user.
2. Ensure that all Webgates are installed for Web server user & group (default: apache).
3. Create an `oracle_access_manager.te` policy file in the `$SELINUX_SRC/domains/programs/directory` and add the following rules:

```
type oracle_access_manager_t, file_type, sysadmfile;
allow httpd_t oracle_access_manager_t:file { rw_file_perms create rename
link unlink setattr execute };
allow httpd_t oracle_access_manager_t:dir { rw_dir_perms create append
rename link unlink setattr };
```

4. Create an `oracle_access_manager.fc` file context in the directory `$SELINUX_SRC/file_contexts/program`, then register the Webgate installation directory (without identity or access suffix). For example:

```
Oracle_Access_Manager_install_dir(/.*)? system_u:object_r:oracle_access_
manager_t
```

Note:

When the Webgate is installed in a separate directory from the Access Manager, be sure to register the Webgate installation directory separately.

5. Compile and deploy the policy files as follows:

```
cd $SELINUX_SRC
make load
Label Oracle Access Manager files
run restorecon -R Oracle_Access_Manager_install_dir (without the identity or
access suffix)
```

31.12.3 Apache v2 Directives

Apache 1.3 uses a process model for serving multiple HTTP requests at once. This differs from the single process (thread) model employed by other Web servers, which manage several requests simultaneously in one process.

Note:

Only the prefork MPM in Apache v2 uses the same process model for serving HTTP requests as Apache v1.3. For all other MPMs, Apache v2 uses a hybrid process-thread model.

Several directives in the Apache v2 Web server configuration file (`httpd.conf`) affect how the Apache Web server decides to create or destroy worker processes. The following parameters affect the performance of the Apache v2 Web server:

- **ThreadsPerChild:** This directive sets the number of threads created by each child process. The child creates these threads at startup and never creates more.
 - If you are using an MPM like `mpm_winnt`, where there is only one child process, this number should be high enough to handle the entire load of the server.
 - If you are using an MPM like `mpm_worker`, where there are multiple child processes, the total number of threads should be high enough to handle the common load on the server.
- **MinSpareThreads:** This value is only used with `mpm_worker`. Since Access Manager plug-in initialization is deferred until the first request, there is minimal advantage of keeping high value for this directive. However, it is useful to keep this parameter as high as possible.
- **MaxSpareThreads:** This value is only used with `mpm_worker`. The value for `MaxSpareThreads` must be greater than or equal to the sum of `MinSpareThreads` and `ThreadsPerChild` or the Apache HTTP Server automatically corrects it.

Recommendation: Keep the value high. For a dedicated server this will not be a problem.

- **MaxSpareServers:** With Apache v2, this is used only with the prefork MPM model. To preserve as much state as possible in the server, set the MaxSpareServers to a high value. Setting this value to the maximum of 255 keeps all Apache worker-processes available indefinitely, but it does not provide an opportunity for worker-process recycling during low-load periods.
- **MinSpareServers:** With Apache v2, this is used only with the prefork MPM model. Since Access Manager plug-in initialization is deferred until the first request, using a high value for the MinSpareServers parameter provides minimal advantage. However, it is useful to keep this parameter as high as possible. For dedicated Web server systems, this should pose no great burden.
- **MaxClients:** With IHS v2 and the worker MPM, MaxClients restricts the total number of threads that will be available to serve clients. For hybrid MPMs, the default value is 16 (ServerLimit) multiplied by a value of 25 (ThreadsPerChild). To increase MaxClients to a value that requires more than 16 processes, you must also raise ServerLimit.

Appropriate values for the preceding parameters depend on the expected load and the performance class of the systems involved, including the Access Server and LDAP server.

Apache servers on very high performance systems with high expected loads may be recompiled with a larger limit on the number of worker processes. These systems may see a greater performance impact on the StartServers and MinSpareServers parameters for dealing with sudden load spikes.

You may need to adjust operating system limits for the Access Server for proper operation. In particular, the maximum number of file descriptors available for any one Access Server may need to be increased beyond the default value. Configuring more than one connection between each Apache-based Webgate and an Access Server may quickly exceed this limit.

For additional information, see your Apache documentation.

31.13 Removing Web Server Configuration Changes After Uninstall

Web server configuration changes that occur during installation must be manually removed after uninstalling the Webgate). This type of information must be removed manually.

Further, you must remove any changes that you manually made to your Web server configuration file for the Webgate) should be removed. For more information about what is added for each component, look elsewhere in this chapter.

31.14 Helpful Information about Building an Apache Release and Source Code

Consult the following manual for more information about the Oracle HTTP Server:

Oracle HTTP Server Administrator's Guide 10 g R2 (10.1.2)

The following URLs provide information about building an Apache release and source code:

Apache v2 documentation:

<http://httpd.apache.org/docs-2.0/>

Apache v2 source code:

<http://httpd.apache.org/download.cgi>

Mod-SSL documentation:

http://httpd.apache.org/docs-2.0/mod/mod_ssl.html

OpenSSL documentation:

<http://www.openssl.org/docs/>

OpenSSL source code:

<http://www.openssl.org/source/>

Compiling and Installing Apache v2:

<http://httpd.apache.org/docs-2.0/install.html#test>

IHS:

<http://www-306.ibm.com/software/webservers/httpservers/doc/v2047/manual/readme.html>

Configuring the ISA Server for 10g WebGates

The following topics describe how to configure the Access Manager ISAPI Webgate and Microsoft Internet Security and Acceleration Server (ISA Server) to operate together:

- [Prerequisites for Configuring the ISA Server for 10g WebGates](#)
- [About Access Manager and the ISA Server](#)
- [Compatibility and Platform Support](#)
- [Installing and Configuring Webgate for the ISA Server](#)
- [Configuring the ISA Server for the ISAPI Webgate](#)
- [Starting, Stopping, and Restarting the ISA Server](#)
- [Removing Access Manager Filters Before Webgate Uninstall on ISA Server](#)

32.1 Prerequisites for Configuring the ISA Server for 10g WebGates

Ensure that your Oracle Access Management Console is running and get familiar with:

- [Introduction to Policy Enforcement Agents](#)
- [About Access Manager and the ISA Server](#)

32.2 About Access Manager and the ISA Server

The ISA Server is Microsoft's "integrated edge security gateway". It is designed to protect IT environments from Internet-based threats and to give users secure remote access to applications and data.

Webgate is the Access Manager Web server plug-in access client that intercepts HTTP requests for Web resources and forwards them to the Access Server for authentication and authorization. ISAPI is the Internet Web server extension that Access Manager uses to identify Webgates that communicate with the ISA Server (and the IIS Web Server).

This Webgate has been tested to operate with the ISA Server in scenarios that use both Access Manager Basic and Form (form-based) authentication schemes. You develop Basic and Form authentication schemes and policy domains using Access Manager as usual.

Note:

Access Manager Client Certificate authentication is not supported for the ISA Server.

See Also:

Administrator's Guide for Oracle Access Management for more information about authentication management and policy domains.

Using ISA Server with Access Manager is similar to using the IIS Web server. However, the ISA Server provides firewall and Virtual Private Network (VPN) functions.

ISA Server can be configured for third-party security filters. To enforce Access Manager security during authentication and authorization when you use ISA Server, both `webgate.dll` and `postgate.dll` must be registered as ISA Server Web filters. Every request to the Access Server that passes through ISA Server requires `webgate.dll` and `postgate.dll`.

The following overview outlines the tasks that you must perform and the topics where you can find the steps to set up the ISAPI Webgate with the ISA Server.

Task overview: Installing and configuring the ISAPI Webgate on Server

1. Confirming "[Compatibility and Platform Support](#)"
2. "[Installing and Configuring Webgate for the ISA Server](#)".
3. "[Configuring the ISA Server for the ISAPI Webgate](#)".
4. Perform the following tasks:
 - a. "[Ordering the ISAPI Filters](#)"
 - b. "[Removing Access Manager Filters Before Webgate Uninstall on ISA Server](#)"

32.3 Compatibility and Platform Support

Get the latest certification matrix from Oracle Technology Network at the following URL:

<http://www.oracle.com/technetwork/middleware/ias/downloads/fusion-certification-100350.html>

32.4 Installing and Configuring Webgate for the ISA Server

After ISA Server installation, you perform the following tasks to install Webgate for use with ISA Server.

See [Compatibility and Platform Support](#).

Task overview: Performing Webgate configuration for ISA Server includes the following topics:

1. [Installing Webgate with ISA Server](#)
2. [Changing /access Directory Permissions](#)

3. [Registering Access Manager Plug-ins as ISA Server Web Filters](#)

32.4.1 Installing Webgate with ISA Server

When you install Webgate with the ISA Server, the destination for the ISAPI Webgate installation (also known as the *Webgate_install_dir*) should be same as that of the Microsoft ISA Server.

For example, if ISA Server is installed on C:\Program Files\Microsoft ISA Server, the ISAPI Webgate should also be installed there.

Note:

During Webgate installation, do not automatically update the ISA Server configuration. Instead, choose "No" when asked about automatic updates to the ISA Server configuration.

Task overview: Installing the ISAPI Webgate for the ISA Server:

1. See [Registering and Managing 10g WebGates with Access Manager 11g](#) for details on the following topic, as these apply to your environment:
 - [Registering a 10g WebGate with Access Manager 11g Remotely](#)
 - [Locating and Installing the Latest 10g WebGate for Access Manager 11g](#)
 - [Configuring Centralized Logout for 10g WebGate with 11g OAM Servers](#)
2. [Changing /access Directory Permissions](#)

32.4.2 Changing /access Directory Permissions

After finishing ISAPI Webgate installation and configuration for the ISA Server, you need to change permissions to the \access subdirectory. This subdirectory was created in the ISA Server (also Webgate) installation directory. You need to add the user NETWORK SERVICE and grant full control to NETWORK ADMINISTRATOR.

This enables the ISA Server to establish a connection between the Webgate and Access Server. Certain configuration files should be readable by network Administrators, which is why you grant NETWORK ADMINISTRATOR full control.

To change permissions for the \access:

1. In the file system, right-click *Webgate_install_dir*\access, and select **Properties**.
2. In the Properties window, click the **Security** tab.
3. Add user "NETWORK SERVICE" and then select "Allow" to give "**Full Control**".
4. For the "NETWORK ADMINISTRATOR", select "**Full Control**".

32.5 Configuring the ISA Server for the ISAPI Webgate

The following topics describe how to configure the ISA Server to operate with the Access Manager ISAPI Webgate.

Task overview: Performing Webgate configuration for ISA Server includes:

1. ["Registering Access Manager Plug-ins as ISA Server Web Filters"](#)
2. ["Configuring ISA Firewall Policies for ISA Web Filters"](#)

32.5.1 Registering Access Manager Plug-ins as ISA Server Web Filters

After resetting ISAPI Webgate permissions, you need to register Access Manager `webgate.dll` and `postgate.dll` plug-ins as Web Filters within ISA Server. Web filters screen all HTTP traffic that passes through the ISA Server host. Only compliant requests are allowed to pass through.

Access Manager authentication schemes define how the user is challenged for credentials, maps user-supplied information, verifies it, and so forth. With the ISA Server, you must choose either Form or Basic authentication as the challenge method. You must also specify a Challenge Parameter to map the credentials provided by the user to the corresponding user profile stored in the directory server.

Note:

If Access Manager libraries are not registered as ISA Web filters, Access Manager authentication could fail. Do not point to `webgate.dll` in the action path for form-based login in the authentication scheme. Instead, specify the path to a dummy file in the `/access` directory as shown here:

```
action= "/access/dummy"
```

For form based authentication, `postgate.dll` must be installed and should be at a higher level than `webgate.dll`.

The following procedure describes how to register Access Manager plug-ins in the ISA Server.

Note:

If you need to undo the filter registration, you can use the following procedure with the `/u` option in the `regsvr32` command. For example: `regsvr32 /u ISA_install_dir\access\oblix\apps\webgate\bin\webgate.dll`

To register Access Manager plug-ins as ISA Server Web filters:

1. Locate the ISA Server installation directory, from which you will perform the following tasks.
2. Run `net stop fwsrv` to stop the ISA Server.
3. Register the `webgate.dll` as an ISAPI Web filter by running `regsvr32 ISA_install_dir\access\oblix\apps\webgate\bin\webgate.dll`.
4. Register the `postgate.dll` as an ISAPI Web filter by running `regsvr32 ISA_install_dir\access\oblix\apps\webgate\bin\postgate.dll`.
5. Restart the ISA Server by running `net start fwsrv` to restart the ISA Server.
6. Proceed to ["Configuring ISA Firewall Policies for ISA Web Filters"](#).

32.5.2 Configuring ISA Firewall Policies for ISA Web Filters

To authenticate users, ISA Server must be able to communicate with the authentication servers. After registering Access Manager `webgate.dll` and `postgate.dll` as ISA Web filters, you must configure the ISA Firewall Policy rule to protect resources that use these Web filters.

Web publishing rules essentially map incoming requests to the appropriate Web servers. Access rules determine how clients on a source network access resources on a destination network. ISA Firewall Policy rules require client membership in a user set: either Firewall clients, authenticated Web clients, or virtual private network (VPN) clients. The ISA Server attempts to match authenticated users based upon ISA Firewall Policy rules.

See Also:

Your ISA Server documentation for details about ISA Firewall Policies and rules

The following procedure describes how to configure an ISA Firewall Policy rule to use with ISA Web filters for Access Manager `webgate.dll` and `postgate.dll`.

Note:

After you perform the following procedure, when you create a listener in the authentication click Allow client authentication over HTTP in Advanced Properties.

To configure ISA policies to enable Access Manager authentication and authorization:

1. From the Start menu, click **All Programs**, click **Microsoft ISA Server**, and then click **ISA Server Management**.
2. From the tree of the ISA Server Management console, locate the name of this server, and then click **Firewall Policy**.
3. From the Tasks tab, click **Publish Web Sites**.
4. In the **Web publishing rule** name field, type a descriptive name for the rule, and then click **Next**.
5. On the Select Rule Action page, confirm that the Allow option is selected, and then click **Next**.
6. In the **Publishing type**, confirm that the **Publish a single Web site or load balancer** option is selected, and then click **Next**.
7. On the Server Connection Security page, click **Use non-secured connections to connect the published Web server or server farm**, and then click **Next**.

Note:

If you are using secured connections, see the server connection security settings provided by ISA Server.

8. Perform the following steps to set internal publishing details:
 - a. In the **Internal site name** box, type the internally-accessible name of the Web server.
 - b. Check the **Use a computer name or IP address to connect to the published server** check box.
 - c. Type the internally-accessible and fully qualified domain name, or type the IP address of the Web server computer, in the **Computer name or IP address** box
 - d. Click **Next**.
9. In the **Public name** box, type the publicly-accessible domain name of the Web server computer, and then click **Next**.
10. To publish a particular folder in the Web site:
 - a. Type the folder name in the **Path (optional)** box to display the full path of the published Web site in the Web site box.
 - b. Click **Next**.
11. In the **Accept requests for** list:
 - a. Click **This domain name (type below)**.
 - b. In the Public name box, type the publicly-accessible fully qualified domain name of the Web site.
 - c. Click **Next**.
12. In the **Web listener** list, either click the **Web listener** to use for this Web publishing rule; otherwise or create a new Web listener, as follows:
 - a. Click **New**, type a descriptive name for the new Web listener, and then click **Next**.
 - b. Click **Do not require SSL secured connections with clients**, and then click **Next**.
 - c. In the **Listen for requests from these networks** list, click the required networks and click to check the **External** box, then click **Next**.
 - d. In the **Select how clients will provide credentials to ISA Server** list, click **No Authentication**, and then click **Next**.
 - e. On the Single Sign On Settings page, click **Next**, and then click **Finish**.
13. **Authentication Delegation:** Perform the following steps in the **Select the method used by ISA Server to authenticate to the published Web server** list:
 - a. Click **No Delegation**.

- b. Click **Client Cannot Authenticate Directly**.
 - c. Click **Next**.
 - This is used by ISA Server to authenticate to the published Web server.
- 14. On the User Sets page:
 - a. Choose **All** (the default user setting) to set the rule that applies to requests from the user sets box.
 - b. Click **Next** and then click **Finish**.
- 15. Click **Apply** to update the firewall policy, and then click **OK**.
- 16. Validate that only applicable ports are open and that the traffic that you would like to pass through is allowed.

32.5.3 Ordering the ISAPI Filters

It is important to ensure that the Webgate ISAPI filters are included in the right order. `postgate.dll` should be loaded before `webgate.dll`.

To order the Webgate ISAPI filters for ISA Server:

- 1. From the Start menu, click All Programs, click Microsoft ISA Server, and then click ISA Server Management.
- 2. Expand Configuration, then check Add-ins to display your Web-filters.
- 3. Right-click the Web-filters and select Properties.
- 4. Confirm the following .dll files appear.

For example:

```
postgate.dll
webgate.dll
```

- 5. Add any missing filters, if needed, then select a filter name and use the up and down arrows to arrange the filter order as shown in step 5.

WARNING:

Confirm that there is only one `webgate.dll` and one `postgate.dll` filter and ensure that these are in an enabled state. Also, ensure that `postgate.dll` is installed at higher priority level than `webgate.dll`.

32.6 Starting, Stopping, and Restarting the ISA Server

When you are instructed to restart the ISA Server during Access Manager Web component installation or setup, make sure that you follow any instructions that appear on the screen.

Also, consider using `net stop fwsrv` and `net start fwsrv` are good ways to stop and start the ISA Server. The `net` commands help to ensure that the Metabase does not become corrupted following an installation.

See the ISA Server documentation.

32.7 Removing Access Manager Filters Before Webgate Uninstall on ISA Server

If you plan to uninstall the Webgate that is configured to operate with the ISA Server, you must first unregister the Access Manager filters manually before you uninstall Webgate.

See Also:

[Registering and Managing 10g WebGates with Access Manager 11g](#) for details about uninstalling 10g Webgates

To unregister filters before Webgate:

1. Stop the ISA Server.
2. Run the following command to unregister webgate.dll.

For example:

```
regsvr32 /u ISA_install_dir\access\oblix\apps\webgate\bin\webgate.dll
```

3. Run the following command to unregister postgate.dll. For example:

```
regsvr32 /u ISA_install_dir\access\oblix\apps\webgate\bin\postgate.dll
```

Configuring the IIS Web Server for 10g WebGates

The following topics summarize activities that you need to perform to configure 10.1.4 WebGate with a Microsoft Internet Information Server (IIS Web server for Windows environments). Unless explicitly stated, the information and steps in the following topics apply equally to 32-bit and 64-bit WebGate installations. Topics include:

- [Prerequisites for Configuring the IIS Web Server for 10g WebGates](#)
- [About WebGate Guidelines for IIS Web Servers](#)
- [Prerequisites for Installing Webgate for IIS 7](#)
- [Updating IIS 7 Web Server Configuration on Windows 2008](#)
- [Completing Webgate Installation with IIS](#)
- [Installing and Configuring Multiple 10g WebGates for a Single IIS 7 Instance](#)
- [Installing and Configuring Multiple Webgates for a Single IIS 6 Instance](#)
- [Finishing 64-bit Webgate Installation](#)
- [Confirming Webgate Installation on IIS](#)
- [About Starting, Stopping, and Restarting the IIS Web Server](#)
- [Removing Web Server Configuration Changes Before Uninstall](#)

33.1 Prerequisites for Configuring the IIS Web Server for 10g WebGates

You need to make sure that your Oracle Access Management Console runs and familiarize yourself with:

- [Introduction to Policy Enforcement Agents](#)
- [About Installing Fresh 10g WebGates to Use With Access Manager 11.1.2](#)

33.2 About WebGate Guidelines for IIS Web Servers

ISAPI is an Internet Web server extension that the WebGate that communicates with the IIS Web server.

For example, you will need the following package to install the WebGates for IIS:

Oracle_Access_Manager10_1_4_3_0_Win32_ISAPI_Webgate

64-bit Webgate: Oracle_Access_Manager10_1_4_3_0_Win64_ISAPI_Webgate.exe

Updating the IIS Web server configuration file is required when installing Webgates. With IIS Web servers, a configuration update involves updating the Web server directly by adding the ISAPI filter and creating extensions required by Access Manager. A filter listens to all requests to the site on which it is installed. Filters can examine and modify both incoming and outgoing streams of data to enhance IIS functionality. ISAPI extensions are implemented as DLLs that are loaded into a process that is controlled by IIS. Like ASP and HTML pages, IIS uses the virtual location of the DLL file in the file system to map the ISAPI extension into the URL namespace that is served by IIS.

Oracle recommends that you update the IIS Web server configuration file automatically during Webgate installation. Automatic updates may take more than a minute. However, updating the IIS Web server configuration file manually takes longer and could introduce unintended errors.

For more specific guidelines, see:

- [About Guidelines for ISAPI WebGates](#)
- [Prerequisites for Installing Any 10g Webgate for IIS 7](#)
- [Prerequisite for Installing a 32-bit Webgate for IIS 7](#)

33.2.1 About Guidelines for ISAPI WebGates

General WebGate preparation and installation details apply to ISAPI WebGates. Additionally, this topic provides specific guidelines for ISAPI WebGates installed with an IIS Web server.

You can install multiple WebGates with a single IIS Web server instance or you might have a 64-bit WebGate.

Note:

Unless explicitly stated, details apply equally to 32-bit and 64-bit Webgates.

lockdown Mode: Before installing the WebGate, ensure that your IIS Web server is *not* in lockdown mode. Otherwise things will appear to be working until the server is rebooted and the metabase re-initialized, at which time IIS will disregard activity that occurred after the lockdown.

Permissions: Setting various permissions for the /access directory is required for IIS Webgates only when you are installing on a file system that supports NTFS. For example, suppose you install the ISAPI Webgate in Simple or Cert mode on a Windows 2000 computer running the FAT32 file system. The last installation panel provides instructions for manually setting various permissions that cannot be set on the FAT32 file system. In this case, these instructions may be ignored.

Virtual Hosts: Each IIS Virtual Web server can have its own Webgate.dll file installed at the virtual level, or can have one Webgate affecting all sites installed at the site level. Either install the Webgate.dll at the site level to control all virtual hosts or install the Webgate.dll for one or all virtual hosts.

postgate.dll: You may also need to install the postgate.dll file at the computer level. The postgate.dll is located in the `\Webgate_install_dir`, as described in "[Installing the Postgate ISAPI Filter](#)". If you perform multiple installations, multiple versions of this file may be created which may cause unusual Access Manager behavior. In this case, you should verify that only one webgate.dll and one postgate.dll exist.

Note:

The postgate.dll is always installed at the site level. If for some reason the Webgate is reinstalled, the postgate.dll is also reinstalled. In this case, ensure that only one copy of the postgate.dll exists at the site level.

Updating Web Server Configuration for Webgate: As with other Webgates, your Web server must be configured to operate with the Webgate. Oracle recommends automatically updating your Web server configuration during installation. However, you can decline the automatic update and instead manually configure your Web server.

See "[Registering a 10g WebGate with Access Manager 11g Remotely](#)".

FAT32 file system: You may receive special instructions to perform during Webgate installation. For example: Setting various permissions for the /access directory is required for IIS Webgates only when you are installing on a file system that supports NTFS. The last installation panel provides instructions for manually setting various permissions that cannot be set on the FAT32 file system. In this case, these instructions can be ignored.

SSL and Client Certificate Authentication: On IIS, if you are using client certificate authentication you must enable SSL on the IIS Web server hosting the Webgate before enabling client certificates for Webgate. You must also ensure that various filters are installed in a particular order. In addition, you may need to install the postgate.dll as an ISAPI filter.

Web Server Releases: Web server details in this chapter apply to the stated release. If the release is not stated, you can presume it is IIS v5. Details specific to IIS v6 or IIS v7 are identified.

See Also:

- [Webgates for IIS v7](#)
 - [Webgates for IIS v6](#)
-

32-bit versus 64-bit Webgates: Unless explicitly stated, all information applies equally to both 32-bit and 64-bit Webgates.

See Also:

- [Webgates for IIS v6](#)
 - [Finishing 64-bit Webgate Installation](#)
-

General Webgate Preparation and Installation Details: Refer to this chapter for IIS-specific guidelines. Refer to [Registering and Managing 10g WebGates with Access Manager 11g](#) for general preparation and installation details.

Completing and Confirming Webgate Installation: Perform tasks relevant to your ISAPI Webgate and IIS version:

See Also:

- [Completing Webgate Installation with IIS](#)
 - [Finishing 64-bit Webgate Installation](#)
 - [Confirming Webgate Installation on IIS](#)
-
-

33.2.1.1 Webgates for IIS v7

General guidelines and Webgate installation are usually the same regardless of the IIS release for which you plan to install a Webgate.

However, there are several topics that you need to review before you install one or more Webgates for IIS v7:

- [Prerequisites for Installing Webgate for IIS 7](#)
- [Updating IIS 7 Web Server Configuration on Windows 2008](#)
- [Installing and Configuring Multiple 10g WebGates for a Single IIS 7 Instance](#)

33.2.1.2 Webgates for IIS v6

General guidelines and Webgate installation are usually the same regardless of the IIS release for which you plan to install a Webgate.

However, there are several topics of interest.

Multiple Webgates with a Single IIS 6 Instance: IIS v6.0 supports hosting multiple Web sites on a single Web server instance and ISAPI Webgate allows you to protect each Web site with a different Webgate.

See Also:

[Multiple Webgates with a Single IIS 6 Instance](#)

64-bit IIS v6 Webgate: Perform installation as you do for all others, using instructions available in [Registering and Managing 10g WebGates with Access Manager 11g](#). If you choose manual Web server configuration during Webgate installation, you can access details in the following path:

Webgate_install_dir\access\oblix\lang\en-us\docs\dotnet_isapi.htm

Following Webgate installation and IIS configuration, perform tasks in "[Finishing 64-bit Webgate Installation](#)".

Earlier Release Webgate Installations: Previously Oracle recommended that you install Webgate in the same physical directory location as Policy Manager. This required a virtual directory named "access" for both Policy Manager and Webgate, which is mapped to the physical location of both Policy Manager and Webgate.

Note:

You can install Webgate 10g (10.1.4.3) for IIS in any location, separate from that of Policy Manager.

33.2.1.3 De-coupling an Earlier Webgate/Policy Manager

If you have an earlier, combined Webgate and Policy Manager installation, you can de-couple the components.

To de-couple an earlier Webgate/Policy Manager:

1. Uninstall any patches applied to the earlier Webgate and Policy Manager, if any.
2. Uninstall the earlier Policy Manager and Webgate combination.
3. Install Policy Manager 10g (10.1.4.3).
4. In a separate directory location, install Webgate 10g (10.1.4.3)

33.2.1.4 Multiple Webgates with a Single IIS 6 Instance

Unless explicitly stated, details in this topic apply equally to 32-bit and 64-bit Webgates.

IIS v6.0 supports hosting multiple Web sites on a single Web server and ISAPI Webgate allows you to protect each Web site with a different Webgate.

Note:

Previous ISAPI Webgate releases did not support multiple Webgates with a single IIS Web server instance. You either had to install one Webgate for all Web sites at the top level, or protect a single Web site by configuring Webgate at the Web site level.

IIS 6 provides application pools that are used to run virtual servers. You can think of an application pool as a group of one or more URLs that are served by a worker process or a set of worker processes. An application pool is a configuration that links one or more applications to a set of one or more worker processes. Because applications in this pool are separated from other applications by worker process boundaries, an application in one application pool is not affected by problems caused by applications in other application pools. Today, Webgate instances can run in different process spaces.

When you have multiple Web sites on a single IIS v6.0 Web server instance, you need to ensure that user requests reach the correct Web site. To do this, you need to configure a unique identity for each site on the server using at least one of the following unique identifiers:

- Host header name
- IP address
- TCP port number

Note:

If you have multiple Web sites on a single server and these are distinguished by IP address and port, multiple Webgates are not required. Starting with release 10.1.4.2.0 virtual hosts on Apache and IIS 6.0 are supported. As a result, a single Webgate on the top level can protect all the Web sites even if the IP addresses are different. This is handled by using different Host Identifiers for each Web site.

You can install multiple Webgates on different Web sites of the same IIS Web server instance. However, several manual steps are required.

See Also:

["Installing and Configuring Multiple Webgates for a Single IIS 6 Instance"](#)

33.3 Prerequisites for Installing Webgate for IIS 7

The following topics provide prerequisites for installing Webgates with IIS v7 Web servers:

- [Prerequisites for Installing Any 10g Webgate for IIS 7](#)
- [Prerequisite for Installing a 32-bit Webgate for IIS 7](#)

33.3.1 Prerequisites for Installing Any 10g Webgate for IIS 7

The following procedure applies to 32-bit and 64-bit Webgates equally.

With Webgate for IIS v7 Web Server, you can use Form-based authentication without enabling pass through functionality only when the `<add segment="bin"/>` entry is not present in the applicationHost.config file.

For example, if you have access/oblix/apps/webgate/bin/webgate.dll as an action in the Form-based authentication scheme, ensure that the `<add segment="bin"/>` entry is not present in the applicationHost.config file. If the entry is present, you must remove it, as described next

33.3.1.1 Locating and Removing the `<add segment="bin"/>` Entry

You can locate and the `<add segment="bin"/>` entry.

To remove:

1. Go to Windows\System32\inetsrv\config and open the applicationHost.config file.
2. Search for the `<hiddenSegments>` module.
3. Remove the entry `<add segment="bin"/>` if it is present.
4. Save the file.

33.3.2 Prerequisite for Installing a 32-bit Webgate for IIS 7

The following procedure applies to 32-bit Webgates only.

The following procedure provides steps to configure a 32-bit Webgate for IIS 7 Web Server to use either Simple or Cert transport security mode. This configuration requires that the IIS 6 Management Compatibility module be installed.

33.3.3 Adding the IIS 6 Management Compatibility Module for a 32-bit Webgate for IIS and Simple or Cert Security

You can add the IIS 6 Management Compatibility module for a 32-bit Webgate for IIS 7 and Simple or Cert Security.

1. From the State menu, click Administrative Tools, and then click Server Manager.
2. In the Server Manager tree, expand Roles, and then click Web Server (IIS).
3. In the Web Server (IIS) pane, Role Services section, click Add Role Services.
4. On the Select Role Services page of the Add Role Services Wizard, click IIS6 Management Compatibility under Management Tools.
5. On the Confirm Installation Selections page, click Install.
6. On the Results page, click Close.

33.4 Updating IIS 7 Web Server Configuration on Windows 2008

You can manually set up Web server for the Webgate and decline automatic Web server updates during Webgate installation.

To display steps to configure IIS Web server on Windows 2008 for ISAPI Webgates:

1. When installing Webgate, click No when asked if you want the automatic Web server update and:
 - a. Read information on a new screen to assist in manually setting up your Web server for the Webgate.
 - b. Click the following item in the table that appears perform the steps that are displayed.

Table 33-1 IIS 7 Webgate Windows Server 2008

Supported Server OS	Microsoft IIS
Windows Server 2008	ISAPI
...	...

2. After performing steps to update the IIS 7 Web server on Windows 2008, return to the Webgate installation screen and click Next, as described in the chapter on Webgate installation.
3. Proceed with "[Completing Webgate Installation with IIS](#)".

33.5 Completing Webgate Installation with IIS

Unless explicitly stated, details in this topic apply equally to 32-bit and 64-bit Webgates.

See Also:

As needed, see:

- [Finishing 64-bit Webgate Installation](#)
- [Installing and Configuring Multiple Webgates for a Single IIS 6 Instance](#)

If you have IIS v7, Oracle recommends the following topics:

- [Updating IIS 7 Web Server Configuration on Windows 2008](#)
 - [Installing and Configuring Multiple 10g WebGates for a Single IIS 7 Instance](#)
-
-

Completing Webgate installation with an IIS Web server, includes the following activities after the installation has been completed.

Task overview: Completing IIS Webgate:

1. [Enabling Client Certificate Authentication on the IIS Web Server](#)
2. [Ordering the ISAPI Filters](#)
3. [Enabling Pass-Through Functionality for POST Data](#)
4. [Protecting a Web Site When the Default Site is Not Setup](#)

33.5.1 Enabling Client Certificate Authentication on the IIS Web Server

Unless explicitly stated, details in this topic apply equally to 32-bit and 64-bit Webgates. If you are using client certificate authentication, you must enable SSL on the IIS Web server. If you select client certificate authentication during setup, you must also add the cert_authn.dll as one of the ISAPI filters.

Note:

The procedures here reflect the sequence for IIS v5. Your environment might be different.

To enable SSL on the IIS Web server:

1. Start the Internet Information Services console, if needed: Click Start, Programs, Administrative Tools, Internet Information Services.
2. Expand the local computer to display your Web Sites.
3. Expand the Default Web Site (or the appropriate Web site), then expand \access\oblix\apps\webgate\bin.
4. Right click cert_authn.dll and select Properties.
5. In the Properties panel, select the File Security tab.
6. In the Secure Communications sub-panel, click Edit.

7. In the Client Certificate Authentication sub-panel, click Accept Certificates and click OK.
8. Click OK in the cert_authn.dll Properties panel.
9. Proceed to the next procedure: "To add cert_authn.dll as an ISAPI filter".

To add cert_authn.dll as an ISAPI:

1. Start the Internet Information Services console, if needed: Click Start, Programs, Administrative Tools, Internet Information Services.
2. Expand the local computer to display your Web Sites.
3. Right click the appropriate Web Site to display the Properties panel.
4. Click the ISAPI Filters tab, then click the Add button to display the Filter Properties panel.
5. Enter filter name "cert_authn".
6. Click the Browse button and navigate to the following directory:
`\Webgate_install_dir\access\oblix\apps\webgate\bin`
7. Select cert_authn.dll as the executable.
8. Click OK on the Filter Properties panel.
9. Click Apply on the ISAPI Filters panel.
10. Click OK.
11. Ensure the filters are listed in the correct order.

33.5.2 Ordering the ISAPI Filters

Unless explicitly stated, details in this topic apply equally to 32-bit and 64-bit Webgates. It is important to ensure that the Webgate ISAPI filters are included in the right order.

Note:

This task is the same whether you are installing one or more Webgates per IIS Web server instance.

To order the Webgate ISAPI filters:

1. Start the Internet Information Services console, if needed: Click Start, Programs, Administrative Tools, Internet Information Services.
2. Expand the local computer to display your Web Sites.
3. Right-click the Web Site and select Properties.
4. Click Properties, select ISAPI filters.
5. Confirm the following .dll files appear.

For example:

cert_authn.dll webgate.dll

6. Add any missing filters, if needed, and then select a filter name and use the up and down arrows to arrange the filter order as shown in step 5.

WARNING:

Confirm that there is only one webgate.dll and one postgate.dll filter. If you perform multiple Webgate installations on one computer, multiple versions of the postgate.dll file might be created and cause unusual Access Manager behavior.

33.5.3 Enabling Pass-Through Functionality for POST Data

You can set up the Webgate in conjunction with IIS 6.0 Worker Process Isolation Mode. They also cover configuration steps required for IIS 6.0 running in IIS 5.0 Isolation Mode.

Note:

This section supersedes information in "Installing Postgate.dll on IIS Web Servers" in the 10g . For the IIS 5.0 Web server, the existing functionality using postgate.dll continues to be supported.

Follow these tasks to enable pass-through functionality for POST Data:

- [About ISAPI Webgate 10.1.4.2.3](#)
- [About Pass-Through Functionality for POST Data](#)
- [Implementing Pass-Through: IIS 6.0 in Worker Process Isolation Mode](#)
- [Implementing Pass-Through with IIS 6.0 Web Server in IIS 5.0 Isolation Mode](#)

33.5.3.1 About ISAPI Webgate 10.1.4.2.3

Starting with ISAPI Webgate release 10.1.4.2.3, Access Manager pass-through functionality is supported with IIS 6.0 running in a Worker Process Isolation Mode. ISAPI Webgate 10.1.4.2.3 also operates with IIS 6.0 running in IIS 5.0 Isolation Mode using postgate.dll.

Note:

Oracle recommends using Worker Process Isolation Mode for new or existing implementations. Worker Process Isolation Mode is a default setting for the IIS 6.0 Web server. For the IIS 5.0 Web server, the existing functionality (using postgate.dll) continues to be supported.

This section describes how to set up ISAPI Webgate release 10.1.4.2.3 in conjunction with IIS 6.0 Worker Process Isolation Mode. It also provides configuration steps required for IIS 6.0 running in IIS 5.0 Isolation Mode. This section supersedes information in Section 19-6 (Installing Postgate.dll on IIS Web Servers) of the .

33.5.3.2 About Pass-Through Functionality for POST Data

POST data is required for pass through during a form login on the IIS Web server when using the Webgate extension method (where the Webgate is the action of the form).

In other words, if a form authentication scheme on the IIS Web server is configured with the pass-through option, and the target of the login form requires the data posted by the form, the Webgate extension method (where the Webgate DLL is the action of the form) cannot be used. The Webgate filter method (where the action of the form is a protected URL that is not the Webgate DLL) must be used instead, and based on IIS version, the `postgate.dll` must be installed or configure `webgate.dll` as ISAPI extension.

IIS 6.0 in Worker Process Isolation Mode: `webgate.dll` must be configured as an ISAPI filter and also as an ISAPI extension to achieve pass-through functionality. (This does not apply to ISA server integration.) Pass-through functionality is supported with 10.1.4.2.3 and higher ISAPI Webgates. However, you must also set a new user-defined parameter "`UseWebGateExtForPassthrough`" to `true` in the Webgate configuration profile in the Access System Console.

IIS 5.0 or IIS6.0 running in IIS 5.0 Isolation Mode: `postgate.dll` must be configured as an ISAPI filter to achieve the pass-through functionality.

33.5.3.3 Implementing Pass-Through: IIS 6.0 in Worker Process Isolation Mode

You can implement Pass-Through Functionality with IIS 6.0 Web Server in Worker Process Isolation Mode.

Task overview:

1. Install Webgate as described in "[Locating and Installing the Latest 10g WebGate for Access Manager 11g](#)".
2. Set the pass-through parameter as described in "[Setting the UseWebGateExtForPassthrough Parameter in the Webgate Profile](#)".
3. Configure `webgate.dll` as described in "[Configuring webgate.dll as an ISAPI Extension](#)".

33.5.3.3.1 Setting the UseWebGateExtForPassthrough Parameter in the Webgate Profile

You must set the new user-defined parameter, `UseWebGateExtForPassthrough`, in the Webgate profile to implement pass-through functionality with the IIS 6.0 Web server in Worker Process Isolation Mode.

You must set: `UseWebGateExtForPassthrough` to `true`. If this parameter is set to `false`, pass-through functionality does not work.

See Also:

["IIS Web Server Issues"](#)

To set the `UseWebGateExtForPassthrough` Parameter in the WebGate Profile:

1. Launch the Access System Console and click Application Security.
2. Click Agents.

3. Enter your search criteria for the WebGate, and then click Search.
4. In the Search Results table, click a WebGate name.
5. Locate the User Defined Parameters section of the Access/WebGate Gate page, enter the following parameter, and click Apply.

Parameter: UseWebGateExtForPassthrough

Value: true

6. Click Apply if you want to add more user-defined parameters.
7. Repeat for each WebGate in your deployment.
8. Proceed to "[Configuring webgate.dll as an ISAPI Extension](#)".

33.5.3.3.2 Configuring webgate.dll as an ISAPI Extension

The webgate.dll is part of the Webgate installation. You can configure webgate.dll as an ISAPI extension.

This task must also be performed to implement pass-through functionality with IIS 6.0 Web Server in Worker Process Isolation Mode.

Note:

You can have multiple webgate.dlls configured at different website levels from the top level Web Sites. In this case, you also need to configure webgate.dll as an ISAPI extension for each website protected by Webgate.

To configure webgate.dll as an ISAPI extension:

1. Go to websites, right click, and select Properties.
2. In the Properties dialog box, select the Home Directory tab.
3. Click the Configurations button to open the Application Configurations dialog box.
4. In Wild Card Application Maps, click the Inset button.
5. Provide the path to webgate.dll. For example:

Webgate_install_dir/access/oblix/apps/webgate/bin/webgate.dll

6. Uncheck the "verify that file exists" box.
7. Confirm and finalize the changes: click OK, then click OK again; click Apply, and then click OK.
8. Stop the IIS Administration Server from Services and restart the IIS Web server.

33.5.3.4 Implementing Pass-Through with IIS 6.0 Web Server in IIS 5.0 Isolation Mode

You can implement Pass-Through Functionality with IIS 6.0 Web Server in IIS 5.0 Isolation Mode.

The following steps outline this task.

Note:

Skip this task if you are using IIS 6.0 Web server in Worker Process Isolation Mode.

Task overview:

1. Install Webgate.
See [Registering and Managing 10g WebGates with Access Manager 11g](#).
2. Set up IIS 6.0.
See "[Setting Up IIS 6.0 Web Server in IIS 5.0 Isolation Mode](#)".
3. Install postgate.dll.
See "[Installing the Postgate ISAPI Filter](#)".

33.5.3.4.1 Setting Up IIS 6.0 Web Server in IIS 5.0 Isolation Mode

When IIS 6.0 Web server is used, you can set up the WWW Service to run in IIS 5.0 Isolation Mode. This is required by the ISAPI postgate filter.

The following information is updated for the 10.1.4.2.3 Webgate.

To set IIS 5.0 isolation on IIS 6 Web servers

1. Start the Internet Information Services console, if needed: Click Start, Programs, Administrative Tools, Internet Information Services.
2. Expand the local computer to display your Web Sites.
3. Right-click the Web Site and select Properties.
4. Select the Service tab in the Web Site Properties window.
5. Check the box beside Run WWW service in IIS 5.0 Isolation Mode.
6. Click OK.
7. Proceed with "[Installing the Postgate ISAPI Filter](#)".

33.5.3.4.2 Installing the Postgate ISAPI Filter

For single Webgate installations, you need to install the filters in the following order.

The following information is updated for the 10.1.4.2.3 Webgate.

- The ISAPI Webgate filter needs to be installed after the sspifilt filter and before any others.
- The postgate filter needs to be installed before the Webgate filter, only if needed.
- All other Access Manager filters can be installed at the end.

Note:

Before installation (or after uninstallation) the filters must be removed manually. If multiple copies of a filter are installed, this means that they were not manually removed before installing the new filters.

You can have multiple webgate.dlls configured at different levels from the top level Web Sites. However, they share the same postgate.dll. If you perform multiple Webgate installations on one computer, multiple versions of the postgate.dll file can be created which might cause unusual Access Manager behavior. There can only be one postgate.dll configured at the (top) Web Sites level of a computer

Note:

postgate.dll is not supported when you have more than one Webgate installed and configured for a single IIS Web server instance.

The following procedures serve as a guide when you install and position the postgate ISAPI filter with a single Webgate installed and a single IIS Web server instance.

To install all the postgate ISAPI:

1. Start the Internet Information Services console, if needed: Click Start, Programs, Administrative Tools, Internet Information Services.
 2. Expand the local computer to display your Web Sites.
 3. Right-click the Web Site and select Properties.
 4. Select the ISAPI Filters tab in the Web Site Properties window.
 5. Click the Add button to display the Filter Properties panel.
 6. Enter the filter name "postgate".
 7. Click the Browse button and navigate to the following directory:
 \Webgate_install_dir\access\oblix\apps\webgate\bin
 8. Select postgate.dll as the executable.
 9. Click OK on the Filter Properties panel.
 10. Click Apply on the ISAPI Filters panel.
 11. Reposition the postgate ISAPI filter, as follows:
 - a. Start the Internet Information Services console, if needed.
 - b. Right-click your local computer, then select All Tasks, select Restart IIS.
 - c. Select the ISAPI Filters tab on the Properties panel.
 - d. Select the postgate filter and move it before Webgate, using the up arrow.
- For example:
- ```
postgate.dll webgate.dll
```



- e. Restart IIS.

---

**Note:**

Consider using `net stop iisadmin` and `net start w3svc` to help ensure that the Metabase does not become corrupted.

---

### 33.5.4 Protecting a Web Site When the Default Site is Not Setup

Unless explicitly stated, this topic applies equally to 32-bit and 64-bit Webgates. When you install a Webgate on an IIS Web server that does not have the "Default Web Site" configured, the installer does not create "Virtual Directory access", which must be done manually.

---

**See Also:**

["Setting Access Permissions, ISAPI filters, and Directory Security Authentication"](#)

---

To protect a Web Site (not the default site):

1. Start the Internet Information Services console, if needed
2. Select the name of the Web site to protect.
3. Right-click the name of the Web site to protect and select New, and then select Virtual Directory in the menu.
4. Click Next.
5. Select Alias: access, then click Next.
6. Directory: Enter the full path to the /access directory, then click Next.  
*Webgate\_install\_dir\access*
7. Select Read, Run Scripts, and Execute, then click Next.
8. Click Finish.
9. Restart IIS.

For example:

Select Start, then Run.  
Type `net start w3svc`.  
Click OK.

## 33.6 Installing and Configuring Multiple 10g WebGates for a Single IIS 7 Instance

You can install and configure multiple Webgates for different Web sites on the same IIS 7 Web server instance. Several steps are manual and will differ from those that are performed when you install a single Webgate with a single IIS instance.

When installing multiple Webgates for a single IIS instance:

- The `webgate.dll` must be configured as an ISAPI filter at the individual Web site level, not the default (top) Web server level
- The `/access` virtual directory is mapped at the Web site level to the respective `/access` directory in the Webgate installation.

When configuring the impersonation DLL for multiple Webgates, you need to configure a user to act as the operating system.

Task overview: Installing and configuring multiple Webgates for a single IIS 7 instance:

1. [Installing Each IIS 7 Webgate in a Multiple Webgate Scenario](#)
2. [Setting the Impersonation DLL for Multiple IIS 7 Webgates](#)
3. [Enabling Client Certification for Multiple IIS 7 Webgates](#)
4. [Configuring IIS 7 Webgates for Pass Through Functionality](#)
5. [Confirming IIS 7 Webgate Installation](#)
6. Perform the following tasks, which are the same whether you install one or more Webgates per IIS Web server instance:
  - ["Ordering the ISAPI Filters"](#)
  - ["Confirming Webgate Installation on IIS"](#)

---

---

**See Also:**

["Confirming Multiple Webgate Installation"](#)

---

---

### 33.6.1 Installing Each IIS 7 Webgate in a Multiple Webgate Scenario

After installing the ISAPI Webgate, there are several manual steps to perform as described here. By default, `webgate.dll` is configured as an ISAPI filter at the host name (top) level. When installing multiple Webgates with a single IIS 7 instance, you need to remove the respective `webgate.dll` from the top level and configure it for the appropriate individual Web site after each Webgate installation.

To install each Webgate when you have several with one IIS 7 instance:

1. Install the ISAPI 7 Webgate.  
See [Registering and Managing 10g WebGates with Access Manager 11g](#).
2. Go to the Web site to protect, and configure `webgate.dll` as the ISAPI filter using these steps:
  - a. Start the Internet Information Services (IIS) Manager: Click Start, Programs, Administrative Tools, Internet Information Services (IIS) Manager.
  - b. Select the *hostname* from the Connections pane.
  - c. From the hostname Home pane, double-click ISAPI Filters, look for any `Webgate.dll`; if it is present, select it and click **Remove** from the Action pane.
  - d. In the Connection pane, under Sites, click the name of the Web Site for which you want to configure a Webgate filter.

- e. In the Home pane, double-click ISAPI Filters.
  - f. In the Actions pane, click Add...
  - g. In the Filter name text box of the Add ISAPI Filter dialog box, type "Webgate" as name for the ISAPI filter.
  - h. In the Executable box, type the file system path of the Webgate ISAPI filter file or click the ellipsis button (...) to go to the folder that contains the Webgate.dll ISAPI filter file, and then click OK.  

```
Webgate_install_dir\access\oblix\apps\webgate\bin\webgate.dll
```
3. Creating a Virtual Directory:
- a. Expand the Sites pane and select the Web Site for which you just configured the ISAPI filter (Webgate.dll).
  - b. On the Action pane, click View Virtual Directories and then select **Add Virtual Directory**.
  - c. Specify **access** in the Alias text box and the physical path to the Webgate **access** folder of Webgate or click the ellipsis button (...) to go to the "access" folder, and then click OK.  

```
Webgate_install_dir\access\
```
  - d. Save and apply these changes.
4. Setting permissions to the Virtual Directory:
- a. Select the "access" virtual directory created in Step 3.
  - b. From the access Home pane, double click Handler Mappings; from the Action pane, select Edit Feature Permissions....
  - c. Check boxes beside Read, Script, and Execute, then click OK.
5. Setting Directory Permissions for Webgate:
- a. In Explorer, right click the Webgate installation directory 

```
Webgate_install_dir\access
```

 and select Properties.
  - b. Click the Security tab and click the Edit button.
  - c. Add user "IUSR", select "Allow" for "Modify".
  - d. Add user "IIS\_IUSRS", select "Allow" for "Modify".
  - e. Add user "NETWORK", select "Allow" for "Modify".
  - f. Add user "NETWORK SERVICE", select "Allow" for "Modify".
  - g. For group "Administrators" select "Allow" for "Modify".
6. Webgate in Simple or Cert Mode:
- a. In the file system, locate and right-click the "password.xml" file in 

```
Webgate_install_dir\access\oblix\config\password.xml
```

, and select Properties.
  - b. Click the Security tab.

- c. Give "Allow" for "Read" rights to users "IUSR", "NETWORK SERVICE", "IIS\_WPG", "IIS\_IUSRS".
7. Ensure that there is no webgate.dll in the top level (the hostname level).
8. Perform the next set of tasks using instructions in the following topics:
  - a. ["Setting the Impersonation DLL for Multiple IIS 7 Webgates"](#)
  - b. ["Enabling Client Certification for Multiple IIS 7 Webgates"](#)
9. Repeat these steps when you install the next Webgate for the IIS instance.

### 33.6.2 Setting the Impersonation DLL for Multiple IIS 7 Webgates

The client's access token is known as an impersonation token. The impersonation token identifies the client, the client's groups, and the client's privileges. The information in the token is used during access checks when the thread requests access to resources on the client's behalf.

Access Manager authenticates and authorizes the user. The Access Manager IISImpersonationExtension.dll in the wildcard extension behaves like a filter for each request to the Web server. Access Manager designates a special user that does have the right to impersonate another user by configuring it using the impersonation username/password on the AccessGate Configuration page. That designated user must have "act as operating system" rights. DLL impersonates the user authenticated and authorized by Access Manager and generates the impersonation token.

You perform the following steps to set the impersonation DLL for each Webgate that protects a Web site for a single IIS 7 Web server instance. You can do this either immediately after the installation task in the previous topic or all at one time.

---

---

**Note:**

This task must be performed for each Webgate that protects an individual Web site for a single IIS Web server instance.

---

---

To add the impersonation DLL to IIS 7 configuration for individual Web site:

1. Start the Internet Information Services (IIS) Manager, if needed: Click Start, Programs, Administrative Tools, Internet Information Services (IIS) Manager.
2. Add "IISImpersonationExtension.dll" as a Wildcard Script Map to the required Web Site:
  - a. Expand Sites in the connection pane.
  - b. Click the Web Site name to which you want to add IISImpersonationExtension.dll.
  - c. Double click Handler Mappings from the selected Web Site's "home" pane.
  - d. From the Action pane, click Add Wildcard Script Map.
  - e. In the Name text box of the Add Wildcard Script Map dialog box, type "Oracle Impersonation Plugin" as name for the dll.

- f. In the Executable box, type the file system path of the Webgate IISImpersonationExtension.dll or click the ellipsis button (...) to go to the folder that contains IISImpersonationExtension.dll, and then click OK.

```
Webgate_install_dir/access/oblix/apps/Webgate/bin/
IISImpersonationExtension.dll
```

This example shows the default path, where *Webgate\_install\_dir* is the file system directory where you have installed this particular Webgate.

3. Proceed as follows:
  - **Client Certificate Authentication:** ["Enabling Client Certification for Multiple IIS 7 Webgates"](#)
  - ["Confirming IIS 7 Webgate Installation"](#).

### 33.6.3 Enabling Client Certification for Multiple IIS 7 Webgates

You perform this task to set the enable client certification for each Webgate that protects a Web site for a single IIS 7 Web server instance.

You can do this either immediately after the adding the impersonation DLL to an individual Web site or all at one time.

---



---

**Note:**

SSL should be enabled on the Web Site before configuring the client certification for Webgate. Follow these steps after the Web Site is SSL enabled.

---



---

If you select client certificate authentication during setup, you must also enable and then add the cert\_authn.dll as one of the ISAPI filters in the respective Web site.

To enable cert\_authn.dll on the IIS 7 Web server:

1. Start the Internet Information Services (IIS) Manager, if needed: Click Start, Programs, Administrative Tools, Internet Information Services (IIS) Manager.
2. Expand Sites in the connection pane.
3. Expand the Web Site to \access\oblix\apps\webgate\bin.
4. Right click the "bin" directory and select Switch To Content View.
5. Right click the "cert\_authn.dll".and from the drop down menu, select Switch To Feature View.
6. From the cert\_authn.dll Home pane, double click SSL Settings.
7. From SSL Settings pane, select Require SSL check-box and select Accept from Client Certificates.
8. Select Apply from Action pane.
9. Repeat for each Webgate installed on this host, for which you want to enable client certification.
10. Restart the IIS 7 Web server.

11. Proceed to the next task: "To add cert\_authn.dll as an ISAPI v7 filter".

To add cert\_authn.dll as an ISAPI v7 filter:

1. Start the Internet Information Services (IIS) Manager, if needed: Click Start, Programs, Administrative Tools, Internet Information Services (IIS) Manager.
2. Expand Sites in the connection pane.
3. Click on the Web Site name for which you want to add "cert\_authn.dll".
4. In the Home pane, double-click ISAPI Filters.
5. In the Actions pane, click Add.
6. In the Filter name box of the Add ISAPI Filter dialog box, type *Oracle Certification Authentication Plugin* as name for the ISAPI filter.
7. In the Executable box, type the file system path of the Webgate cert\_authn.dll or click the ellipsis button (...) to go to the folder that contains cert\_authn.dll, and then click OK.

*Webgate\_install\_dir/access/oblix/apps/Webgate/bin/cert\_authn.dll*

This example shows the default path, where *Webgate\_install\_dir* is the file system directory where you have installed this particular Webgate.

8. Click View Ordered List from the Action pane and arrange the filters as shown here by using "Move Up" or "Move Down":  
  
cert\_authn.dll webgate.dll
9. Select Apply from Action pane.
10. Repeat for each Webgate installed on this host, for which you want to enable client certification.
11. Restart the IIS 7 Web server.
12. Proceed as needed for your deployment:
  - ["Configuring IIS 7 Webgates for Pass Through Functionality"](#)

### 33.6.4 Configuring IIS 7 Webgates for Pass Through Functionality

Here you will add Webgate.dll as a Wildcard Script Map to the required Web Site.

While configuring Webgate to work with pass through functionality, you must ensure that "Physical Path" of the Web sites on which you are installing Webgates differ. Otherwise, the changes in "Handler Mappings" are reflected in all the Web Sites sharing the same physical path.

**Note:**

"Physical Path" is the path that is provided at the time of creating the Web Site. To check this path after the creation of the Web Site, , In Action pane click on Basic Settings..., you will be presented with a window showing the physical path of the Web Site.

- Click the Web Site name.
- In the Action pane, click Basic Settings.

To configure for pass through functionality:

1. Start the Internet Information Services (IIS) Manager, if needed: Click Start, Programs, Administrative Tools, Internet Information Services (IIS) Manager.
2. Expand Sites in the connection pane.
3. Click the Web Site name for which you want to enable pass through.
4. Double click Handler Mappings from the selected Web Site's "home" pane.
5. From the Action pane, click Add Wildcard Script Map.
6. In the Name text box of the Add Wildcard Script Map dialog box, type Webgate as name for the ISAPI filter.
7. In the Executable box, type the file system path of the Webgate ISAPI filter file (Webgate.dll) or click the ellipsis button (...) to go to the folder that contains the Webgate.dll ISAPI filter file, and then click OK.  
*Webgate\_install\_dir/access/oblix/apps/Webgate/bin/Webgate.dll*
8. In the Access System Console:
  - a. Locate the Web Gate profile and click Modify.
  - b. Under User Defined Parameters, enter the following parameter and value:  
UseWebGateExtForPassthrough  
true
  - c. Save the profile.
9. Repeat for each Webgate installed on this host, for which you want to enable pass through.
10. Restart the IIS 7 Web server.
11. Proceed to the next task: "[Confirming IIS 7 Webgate Installation](#)".

### 33.6.5 Confirming IIS 7 Webgate Installation

You can confirm the IIS 7 Webgate installation.

To verify IIS 7 Webgate installation:

1. Go to the URL:

`http(s)://hostname:port/access/oblix/apps/webgate/bin/webgate.dll?progid=1`

where *hostname* refers to the name of the computer hosting the Webgate; *port* refers to the Web server instance port number.

2. The Webgate diagnostic page should appear.
  - **Successful:** If the Webgate diagnostic page appears, the Webgate is functioning properly and you can dismiss the page.
  - **Unsuccessful:** If the Webgate diagnostic page does not open, the Webgate is not functioning properly. In this case, the Webgate should be uninstalled and reinstalled. For more information about removing Access Manager see the Chapter 22, then return to the chapter on installing a Webgate.

## 33.7 Installing and Configuring Multiple Webgates for a Single IIS 6 Instance

Unless explicitly stated, this topic applies equally to 32-bit and 64-bit Webgates. You can install and configure multiple Webgates for different Web sites on same IIS Web server instance. Several steps are manual and differ from those that are performed when you install a single Webgate with a single IIS instance.

---

---

**See Also:**

["Installing and Configuring Multiple 10g WebGates for a Single IIS 7 Instance"](#)

---

---

When you install multiple Webgates for a single IIS instance:

- The `webgate.dll` must be configured as an ISAPI filter at the individual Web site level, not the default (top) Web server level
- The `/access` virtual directory is mapped at the Web site level to the respective `/access` directory in the Webgate installation.

When configuring the impersonation DLL for multiple Webgates, you need to configure a user to act as the operating system.

There can only be one `postgate.dll` configured at the (top) Web Sites level of a machine. However, you might have multiple `webgate.dlls` configured at different levels below the top level Web Sites. If you perform multiple Webgate installations on one machine, multiple versions of the `postgate.dll` file might be created that can cause unusual Access Manager behavior.

Task overview: Installing and configuring multiple Webgates for a single IIS instance:

1. [Installing Each Webgate in a Multiple Webgate Scenario](#)
2. [Setting the Impersonation DLL for Multiple Webgates](#)
3. [Enabling SSL and Client Certification for Multiple Webgates](#)
4. Perform the following tasks, which are the same whether you install one or more Webgates per IIS Web server instance:
  - ["Ordering the ISAPI Filters"](#)
  - ["Confirming Webgate Installation on IIS"](#)



---

**See Also:**

["Confirming Multiple Webgate Installation"](#)

---

### 33.7.1 Installing Each Webgate in a Multiple Webgate Scenario

Unless explicitly stated, this topic applies equally to 32-bit and 64-bit Webgates. After installing the ISAPI Webgate, there are several manual steps to perform as described here. By default, `webgate.dll` is configured as an ISAPI filter at the Web sites (top) level. When installing multiple Webgates with a single IIS instance, you need to remove the respective `webgate.dll` from the top level and configure it for the appropriate individual Web site after each Webgate installation.

---

**Note:**

If you perform multiple Webgate installations on one machine, multiple versions of the `postgate.dll` file might be created which can cause unusual Access Manager behavior. The `postgate.dll` is not supported in environments where you have multiple Webgates configured with a single IIS v6 web server instance.

---

To install each Webgate when you have several with one IIS instance:

1. Install the ISAPI Webgate as described in [Registering and Managing 10g WebGates with Access Manager 11g](#).
2. Go to the Web site to protect, and configure `webgate.dll` as the ISAPI filter using these steps:
  - a. Start the Internet Information Services (IIS) Manager: Click Start, Programs, Administrative Tools, Internet Information Services (IIS) Manager
  - b. Right click **Web Sites**, and then click the **Properties** option.
  - c. Click the ISAPI filter tab, look for the path to `webgate.dll`; if it is present in the filter, then select it and click the **Remove** button.
  - d. Under Web Sites, right-click the name of the Web site to protect, and select the **Properties** option.
  - e. Click the ISAPI filter tab to add the filter DLLs.
  - f. Add the following filter to identify the path to the `webgate.dll` file, and name it "webgate".  
`Webgate_install_dir/access/oblix/apps/webgate/bin/webgate.dll`
  - g. Save and apply these changes.
  - h. Go to the **Directory Security** tab.
  - i. Confirm that "anonymous access" and "basic authentication" are selected so that Access Manager provides authentication for this Web server.
  - j. Save and apply these changes.

3. Go to Web sites level to protect and create an /access virtual directory that points to the newly installed *Webgate\_install\_dir*:
  - a. Under **Web Sites**, right-click the name of the Web site to be protected.
  - b. Select **New** and create a new virtual directory named *access* that points to the appropriate *Webgate\_install\_dir/access*.
  - c. Under **Access Permissions**, check **Read**, **Run Scripts**, and **Execute**.
  - d. Save and apply these changes.
4. In the file system, set directory permissions for Access Manager:
  - a. In the file system, locate and right-click *Webgate\_install\_dir/access*, and the select **Properties**.
  - b. Click the **Security** tab.
  - c. Add user "IUSR\_*machine\_name*" and then select "Allow" for "Modify".  
For example, for a *machine\_name* of Oracle, select IUSR\_ORACLE.
  - d. Add user "IWAM\_*machine\_name*" and then select "Allow" for "Modify".  
For example, for a *machine\_name* Oracle, select IWAM\_ORACLE.
  - e. Add user "IIS\_WPG" and then select "Allow" for "Modify".
  - f. Add user "NETWORK SERVICE" and then select "Allow" for "Modify".
  - g. For the group "Administrators", select "Allow" for "Modify".
5. If Webgate has been set up in Simple or Cert mode, perform the follow steps:
  - a. In the file system, locate and right-click the "password.xml" file in *Webgate\_install\_dir/access/oblix/config/password.xml*.
  - b. Click the Security tab.
  - c. Give "Allow" for "Read" rights to users "IUSR\_*machine\_name*", IWAM\_*machine\_name*, "IIS\_WPG", and "NETWORK SERVICE".
6. Add a new Web service extension using the following steps:
  - a. Right click **Web Service Extensions**, and then select **Add a new Web service extension....**
  - b. Add the Extension name **Oracle Webgate**.
  - c. Click **Add** to add the path to the extension file, and then enter the path to the appropriate webgate.dll.  
*Webgate\_install\_dir/access/access/oblix/apps/webgate/bin/webgate.dll*
  - d. Click **OK** to save the changes.
  - e. Check box beside **Set extension status to allowed**.
  - f. Click **OK** to save the changes.

7. Ensure that there is no `webgate.dll` in the ISAPI filter at the top Web site level ("web sites").
8. Perform the next set of tasks using instructions in the following topics:
  - a. ["Setting the Impersonation DLL for Multiple Webgates"](#)
  - b. ["Enabling SSL and Client Certification for Multiple Webgates"](#)
9. Repeat these steps when you install the next Webgate for the IIS instance.

### 33.7.2 Setting the Impersonation DLL for Multiple Webgates

Unless explicitly stated, this topic applies equally to 32-bit and 64-bit Webgates and IIS v6. You can add the impersonation DLL to IIS configuration for individual websites.

The client's access token is known as an impersonation token. The impersonation token identifies the client, the client's groups, and the client's privileges. The information in the token is used during access checks when the thread requests access to resources on the client's behalf.

The Access System authenticates and authorizes the user.

`IISImpersonationExtension.dll` of Access Manager in the wildcard extension behaves like a filter for each request to the Web server. The Access System designates a special user that does have the right to impersonate another user by configuring it using the impersonation username/password on the AccessGate Configuration page. That designated user must have "act as operating system" rights. DLL impersonates the user authenticated and authorized by Access Manager and generates the impersonation token.

You perform the following steps to set the impersonation DLL for each Webgate that protects a Web site for a single IIS Web server instance. You can do this either immediately after the installation task in the previous topic or all at one time.

---

---

**Note:**

This task must be performed for each Webgate that protects an individual Web site for a single IIS Web server instance.

---

---

To add the impersonation DLL:

1. Start the Internet Information Services (IIS) Manager, if needed: Click Start, Programs, Administrative Tools, Internet Information Services (IIS) Manager.
2. Click the plus icon (+) beside the Local Computer icon in the left pane to display your Web Sites.
3. Click **Web Service Extensions** in the left pane.
4. Double-click **Webgate** in the right pane to open the Properties panel.
5. Click the **Required Files** tab.
6. Click **Add**.
7. In the Path to file text box, type the full path to `IISImpersonationExtension.dll`, and then click OK. For example:

```
Webgate_install_dir\access\oblix\apps\webgate\bin\IISImpersonationExtension.dll
```

This example shows the default path, where *Webgate\_install\_dir* is the file system directory where you have installed this particular Webgate.

8. Verify that the Allow button beside the Webgate icon is grayed out, which indicates that the dll is allowed to run as a Web service extension.
9. Right click the Web site name, and then click **Properties**.
10. Click the **Home Directory** tab, and then click the **Configuration** button.
11. In the list box for Wildcard application maps, click the entry for `IISImpersonationExtension.dll` to highlight it, then click **Edit**.
12. Ensure that the box is unchecked, and then click **OK**.
13. Repeat these steps for each Webgate and Web site pair for the IIS Web server instance.
14. Proceed as follows:
  - **Client Certificate Authentication:** "[Enabling SSL and Client Certification for Multiple Webgates](#)"
  - "[Confirming Multiple Webgate Installation](#)".

### 33.7.3 Enabling SSL and Client Certification for Multiple Webgates

You can enable SSL on the IIS v6 Web and add `cert_authn.dll` as an ISAPI filter.

You perform this task to set the enable client certification for each Webgate that protects a Web site for a single IIS Web server instance. You can do this either immediately after the adding the impersonation DLL to an individual Web site or all at one time.

---

---

**Note:**

Procedures in this topic apply equally to 32-bit and 64-bit Webgates, and IIS 6, unless stated otherwise.

---

---

If you select client certificate authentication during setup, you must also add the `cert_authn.dll` as one of the ISAPI filters in the respective Web site.

To enable SSL on the IIS v6 Web:

1. Start the Internet Information Services (IIS) Manager, if needed: Click Start, Programs, Administrative Tools, Internet Information Services (IIS) Manager.
2. Expand the local computer icon to display your Web Sites.
3. Expand the appropriate individual Web Site, then expand `\access\oblix\apps\webgate\bin`.
4. Right click `cert_authn.dll` and select **Properties**.
5. In the Properties panel, select the **File Security** tab.
6. In the Secure Communications sub-panel, click **Edit**.

7. In the Client Certificate Authentication sub-panel, click **Accept Certificates** and click **OK**.
8. Click **OK** in the cert\_authn.dll Properties panel.
9. Repeat for each Webgate installed on this host.
10. Proceed to the next task: "To add cert\_authn.dll as an ISAPI filter".

To add cert\_authn.dll as an ISAPI filter:

1. Start the Internet Information Services console, if needed.
2. Expand the local computer to display your Web Sites.
3. Right click the appropriate Web Site to display the Properties panel.
4. Click the **ISAPI Filters** tab, then click the **Add** button to display the Filter Properties panel.
5. Enter filter name "cert\_authn".
6. Click the **Browse** button and navigate to the following directory:  
`\Webgate_install_dir\access\oblix\apps\webgate\bin`
7. Select cert\_authn.dll as the executable.
8. Click **OK** on the **Filter Properties** panel.
9. Click **Apply** on the **ISAPI Filters** panel.
10. Click **OK**.
11. Repeat for each Webgate installed on this host.
12. Ensure the filters are listed in the correct order.
13. Proceed to "[Confirming Multiple Webgate Installation](#)".

### 33.7.4 Confirming Multiple Webgate Installation

This task applies equally to 32-bit and 64-bit Webgates, and IIS v6 Web servers. If you perform multiple Webgate installations on one machine, multiple versions of the postgate.dll file might be created which can cause unusual Access Manager behavior. the postgate.dll is not supported in environments where you have multiple Webgates configured with a single IIS v6 web server instance.

---

**See Also:**

- "[Finishing 64-bit Webgate Installation](#)"
  - "[Confirming Webgate Installation on IIS](#)"
- 

## 33.8 Finishing 64-bit Webgate Installation

You can complete installation of a 64-bit Webgate. Then confirm the installation on IIS and implement Windows impersonation.

You can skip this section if you are installing a 32-bit Webgate. In this case, see instead, "[Completing Webgate Installation with IIS](#)".

Before you start tasks here, be sure that you have completed Webgate installation according to information in [Registering and Managing 10g WebGates with Access Manager 11g](#). You must also have completed Web server configuration updates for this Webgate either automatically during Webgate installation or manually, as described in "[Webgates for IIS v6](#)".

Task overview: Finishing the installation of a 64-bit Webgate:

1. Perform steps in "[Setting Access Permissions, ISAPI filters, and Directory Security Authentication](#)".
2. Enable client certificates, if desired. See "[Setting Client Certificate Authentication](#)".
3. When finished, you can:
  - Confirm operations as described in "[Confirming Webgate Installation on IIS](#)"
  - Implement Windows Impersonation, as described in the .

### 33.8.1 Setting Access Permissions, ISAPI filters, and Directory Security Authentication

Unless explicitly stated, this topic applies equally to 32-bit and 64-bit Webgates. It describes setting access permissions for the Web site that you are using as a default.

To set or confirm access Permissions, ISAPI filters, and Directory Security Authentication:

1. Start the Internet Service Manager. For example, from the Start menu click Programs then click Administrative Tools, and click Internet Service Manager.
2. Expand the local computer by clicking +, in the left panel.
3. Click to expand the Web Sites tab.
4. Right-click Default Web Site (or the site you are using as a default), and create a virtual directory as described in "[Protecting a Web Site When the Default Site is Not Setup](#)".
5. Right-click **Web Sites** in the Internet Information Services tab, click **Properties**, and perform the following steps:
  - a. From the Internet Information Services tab, click the **Edit** button.
  - b. Locate the ISAPI filter tab to confirm (or add) the filter DLLs, as follows:

**Filter:** If you updated the IIS Web server configuration file, webgate.dll should be properly located.

**No Filter:** Add the webgate.dll filter from *Webgate\_install\_dir*\oblix\access\apps\webgate\bin\webgate.dll
  - c. Save and apply any changes.
  - d. Click the Directory Security tab and confirm that both **Anonymous Access** and **Basic Authentication** are selected.

**Selected:** Proceed to Step 6.

**Not Selected:** Select **Anonymous Access** and **Basic Authentication**, then save and apply these changes.

6. Proceed as follows:
  - ["Setting Client Certificate Authentication"](#), if desired
  - **No Client Certificate Authentication:** Restart the IIS Web server.
  - **Filter Positions:** Perform instructions in ["Ordering the ISAPI Filters"](#) to ensure that all filters have been added and are in the proper order.

### 33.8.2 Setting Client Certificate Authentication

This task is optional and should be performed only if you want to use client certificate authentication. In this case, IIS and Webgate must be SSL-enabled.

Information in this topic is a sub set of details in ["Enabling Client Certificate Authentication on the IIS Web Server"](#).

To add cert+authn.dll as an ISAPI filter:

1. Start the Internet Information Services console, if needed: Click Start, Programs, Administrative Tools, Internet Service Manager.
2. Expand the local computer to display your Web Sites.
3. Right-click the Default Web Site (or the Web site that you use as a default), then expand \access\oblix\apps\webgate\bin.
4. Right click cert\_authn.dll and select Properties, then:
  - a. In the Properties panel, select the File Security tab.
  - b. In the Secure Communications sub-panel, click Edit.
  - c. In the Client Certificate Authentication sub-panel, click Accept Certificates and click OK.
  - d. Click OK in the Secure Communications panel.
  - e. Click OK in the cert\_authn.dll Properties panel.
5. Click the **ISAPI Filters** tab, click the **Add** button to display the Filter Properties panel, and then:
6. Ensure the filters are listed in the correct order, as described in ["Ordering the ISAPI Filters"](#).
7. Proceed to ["Confirming Webgate Installation on IIS"](#).

### 33.9 Confirming Webgate Installation on IIS

After installing Webgate and updating the IIS Web server configuration file, you can use the Webgate diagnostics to verify the Webgate is properly installed.

---

---

**Note:**

This task is the same for both 32-bit and 64-bit Webgates. It is the same whether you are installing one or more Webgates per IIS Web server instance.

---

---

To verify a Webgate installation:

1. Go to the URL:

```
http(s)://hostname:port/access/oblix/apps/webgate/bin/webgate.dll?progid=1
```

where *hostname* refers to the name of the computer hosting the Webgate; *port* refers to the Web server instance port number.

2. The Webgate diagnostic page should appear.
  - **Successful:** If the Webgate diagnostic page appears, the Webgate is functioning properly and you can dismiss the page.
  - **Unsuccessful:** If the Webgate diagnostic page does not open, the Webgate is not functioning properly. In this case, the Webgate should be uninstalled and reinstalled. For more information about removing Access Manager see "[Removing a 10g WebGate from the Access Manager 11g Deployment](#)", in the chapter on installing a 10g Webgate [Registering and Managing 10g WebGates with Access Manager 11g](#).

## 33.10 About Starting, Stopping, and Restarting the IIS Web Server

When instructed to restart your IIS Web server during Webgate installation or setup, be sure to follow any instructions that appear on the screen. Consider using `net stop iisadmin` and `net start w3svc`, good ways to stop and start the Web server.

The `net` commands help to ensure that the Metabase does not become corrupted following an installation.

## 33.11 Removing Web Server Configuration Changes Before Uninstall

The information in this section applies equally to 32-bit and 64-bit Webgates. Web server configuration changes that occur during installation must be manually reverted after uninstalling the Webgate.

For example, the ISAPI transfilter will be installed for IIS Webgate. However, if you uninstall Webgate this is not removed automatically. Also, the created Web service extension and the link to the identity directory will not be removed. This type of information must be removed manually. These are examples of information to remove, not a complete list.

Further, you must remove any changes that you manually made to your Web server configuration file for the Webgate should be removed. For more information about what is added for each component, look elsewhere in this chapter.

To fully remove a Webgate and related filters from IIS, you must do more than simply remove the filters from the list in IIS. IIS retains all of its settings in a metabase file. On Windows 2000 and later, this is an XML file that can be modified by hand. There is also a tool available, MetaEdit, to edit the metabase. MetaEdit looks like Regedit and has a consistency checker and a browser/editor. To fully remove a Webgate from IIS, use MetaEdit to edit the metabase.



---

# Configuring Lotus Domino Web Servers for 10g WebGates

---

The following topics provide tips about installing and configuring Lotus Domino to operate with the 10g WebGate:

- [Prerequisites for Configuring Lotus Domino Web Servers for 10g WebGates](#)
- [Installing the Domino Web Server](#)
- [Setting Up the First Domino Web Server](#)
- [Starting the Domino Web Server](#)
- [Enabling SSL by Generating a Keyring and a Stash File](#)
- [Installing a Domino Security \(DSAPI\) Filter](#)

---

**Note:**

The information here presumes that you are familiar with your operating system commands, Lotus Notes, and the Domino Web server.

---

## 34.1 Prerequisites for Configuring Lotus Domino Web Servers for 10g WebGates

Make sure that the Oracle Access Management Console is running.

You need to be familiar with:

- [Introduction to Policy Enforcement Agents](#)
- [About Installing Fresh 10g WebGates to Use With Access Manager 11.1.2](#)

## 34.2 Installing the Domino Web Server

Before you install the WebGate with a Domino Web server, you need a properly installed and set up Domino Enterprise Server R5.

The following information focuses on Solaris. However, with some modifications, these steps can be used as a guide for other UNIX systems.

---

**Note:**

You need to register if this is the first time you download from lotus.com.

---

To download the Domino Web server on UNIX:

1. Download Lotus Domino from the following URL:

```
http://www-10.lotus.com/ldd/down.nsf
```

2. Untar the downloaded file to your staging area. For example:

```
gct@planetearth[/export/users2/gct/temp] 433 : ls C37UUNA.tar
```

```
gct@planetearth[/export/users2/gct/temp] 434 : tar xf C37UUNA.tar
```

```
gct@planetearth[/export/users2/gct/temp] 435 : ls C37UUNA.tar sol/
```

You need to install Domino as user "root". The installation script creates soft link, /opt/lotus, to link to your Lotus Domino installation directory.

To install the Domino Web server on UNIX:

1. Run the install script for the Domino Web server. For example:

```
gct@planetearth[/export/users2/gct/temp/sol] 441 : su root
Password:
root@planetearth[/export/users2/gct/temp/sol] 1 : ls
install* license.txt script.dat sets/ tools/
root@planetearth[/export/users2/gct/temp/sol] 2 :
root@planetearth[/export/users2/gct/temp/sol] 2 : ./install
=====
Domino Server Installation
=====
Welcome to the Domino Server Install Program.
Type h for help on how to use this program.
Press TAB to begin the installation.

Type h for help
Type e to exit installation
Press TAB to continue to the next screen.

```

You are asked to select the setup type.

2. Select Setup type. For example:

```
Select Setup type: [Domino Enterprise Server]
```

3. Complete the installation with the following considerations in mind.

For example:

- The default program directory is set to /opt/lotus. You may over write it to another directory. For example, /export/home/WWW/lotus.
- The default data directory is set to /local/notesdata1. You may also over write this to something else. For example, /export/home/WWW/lotus/data1.
- Overwrite Domino UNIX user to own data directory. The default user is set to notes. You may change it to a valid UNIX user. For example, gct or root.
- Overwrite "The UNIX user for this directory must be a member of this group". The default group is set to notes. You may change it to a valid UNIX group name.

For example: oblix.

---

**Note:**

Be sure to include the Domino data directory in the \$PATH before you proceed from here

---

## 34.3 Setting Up the First Domino Web Server

After successfully installing, you must set up the first Domino server.

To set up the first Domino server:

1. Run `/opt/lotus/bin/http httpsetup`.

By default, Domino uses port 8081.

2. Ensure that port 8081 is not already in use.
3. Launch a browser and enter the URL that follows.

For example:

```
http://hostname:8081
```

4. Follow instructions on the screen and keep the following in mind.
  - Check HTTP to get the Web server.
  - Ensure the designated Administrator has a first and last name.
  - Keep passwords simple, and record them in a safe location. For example, `oracleoracle`.
5. Run all commands as the UNIX user that you've configured for this Domino Web server.

---

**WARNING:**

Do not run as root.

---

## 34.4 Starting the Domino Web Server

After successfully setting up the first Domino Web server, you must start it.

To start the Domino Web server:

1. Run `/opt/lotus/bin/server`.
2. Launch your browser and enter the following URL.

For example:

```
http://hostname:80/names.nsf
```

You are prompted for the login name and password.

3. Select Server-Server.
4. Select the server that you want to start.
5. Select Edit Server.

6. Select Ports, select Internet Ports, then click Web.
7. Change the value for TCP/IP port number to your desired port number.
8. Click Save and then Close to save all your changes.
9. Restart server `/opt/lotus/bin/server`.

## 34.5 Enabling SSL by Generating a Keyring and a Stash File

This is optional. Enabling SSL is not mandatory for the WebGate. By generating a Keyring and a stash file, you can enable SSL.

If you need to generate a keyring file (.kyr) and its corresponding stash file (.sth) from the Lotus Notes client on a Windows system to the UNIX system, use the following steps.

To enable SSL by generating a Keyring and a stash file:

1. Start the Lotus Notes Client on your Windows system.  
For example:  
File, select Databases, then click Open
2. Select Server Certificate Admin.
3. Create the key ring file.
4. Create the certificate request.
5. Install the trusted root certificate into the key ring file.
6. Install the certificate into the key ring file.
7. Copy or ftp the newly created keyring file and stash file from the Windows system to your UNIX computer.
8. Store both files in your Domino data directory.

To enable SSL

1. Start a browser and enter the following URL.  
For example:  
`http://hostname:port/names.nsf`  
You will be prompted for login name and password
2. Select Server-Server.
3. Select your intended server.
4. Select Edit Server.
5. Select Ports, select Internet Ports, then click Web.
6. In the SSL Key file name field, enter the absolute path to the keyring file.
7. Change the SSL Port number value to your desired port number.
8. Enable SSL port status.

9. Select Client Certificate "Yes" for Client Certificate authentication.
10. Click Save and Close to save all your changes.
11. Restart the Web server.

For example:

```
/opt/lotus/bin/server
```

## 34.6 Installing a Domino Security (DSAPI) Filter

The Domino security API filter, DSAPI, is an authentication method that enables you to register a DLL with the Domino Web server. In this case, the Web server calls the WebGate DLL to authenticate the user when a request for authentication occurs rather than using SSL or basic authentication. Authentication within Domino is optional with the Access Manager DSAPI filter. You can implement certain aspects of authentication that the default Web server does not support.

Task overview: Completing WebGate and filter installation:

1. Before you install the WebGate on a Domino Web server, complete all the previous steps.
2. Complete the WebGate installation and Web server update.  
See [Locating and Installing the Latest 10g WebGate for Access Manager 11g](#).
3. Set `ObWebGateInstallDir=$WEBGATE_INSTALL_DIR` in your `notes.ini` file.
4. Choose one of the options as described in the following topic:  
See [Completing the WebGate Installation](#).

### 34.6.1 Completing the WebGate Installation

You must make sure that the Domino Web Server can use the WebGate DLL. You need to edit the enter the name or names of the DLL/DLLs (DSAPI libraries) to be called for authentication in the DSAPI filter file names field of the HTTP tab under the Internet Protocols tab in the Server document.

You can select one of the following filters to install the filter:

- Through a Web browser and `names.nsf` (option 1)
- Through a Lotus Notes workstation and the Address Book (option 2)

#### Option 1: To set up the DSAPI filter to access `names.nsf`:

1. Go to the `names.nsf` URL and log in. For example:

```
http://hostname:port/names.nsf
```

2. Click the Server-Servers link.  
A Java applet will be loaded.
3. Select a server from those listed.
4. Click the Edit Server link to go to Edit mode.
5. Click the Internet Protocols link.

By default, the HTTP tab is selected and information is displayed in Edit mode.

6. Look for DSAPI where it says "DSAPI filter file names:", then type in the absolute path to the libwebgate.so file.
7. Save your changes.
8. Restart the Domino http server task.

**Option 2: to access the Address Book through Lotus Notes:**

1. Open Domino Name and Address book. For example, select:  
File, Database, Open, then click Address Book
2. Switch to server view and open the server document.
3. Edit the server document.
4. Click the Internet Protocols tab.

By default, the HTTP tab is selected and information is displayed in Edit mode.

5. Look for DSAPI where it says "DSAPI filter file names:", then type in the absolute path to the libwebgate.so file.
6. Save your changes.
7. Restart the Domino http server task.

# Part VIII

---

## Managing the Adaptive Authentication Service and Oracle Mobile Authenticator

The Adaptive Authentication Service is a One Time Password Authenticator that provides *multifactor* authentication in addition to the standard user name and password type authentication.

This section contains the following chapters:

- [Introducing the Adaptive Authentication Service](#)
- [Configuring the Oracle Mobile Authenticator](#)





---

## Introducing the Adaptive Authentication Service

The Adaptive Authentication Service offers stronger *multifactor* (also referred to as second factor) authentication for sensitive applications that require additional security in addition to the standard user name and password type authentication.

Multifactor authentication involves more than one stage when verifying the identity of an entity attempting to access services from a server or on a network. For example, when multifactor authentication is enabled and configured, the traditional user name and password is the first factor. Additional security is enforced by adding a One Time Pin (OTP) step, or an Access Request (Push) Notification step as a second factor in the authentication process.

The following topics describe how the Adaptive Authentication Service and Access Manager Second Factor Authentication:

- [About Adaptive Authentication Service](#)
- [Working with the Adaptive Authentication Service](#)
- [Understanding Adaptive Authentication Service and OMA Configurations](#)
- [Configuring an Adaptive Authentication Service](#)

### 35.1 About Adaptive Authentication Service

The Adaptive Authentication Service offers the ability to add multiple steps to the authentication process.

Additional security may be enforced by adding a OTP step, or an Access Request (Push) Notification step after initial user authentication. This may or may not involve the use of the Oracle Mobile Authenticator, a mobile device app that uses Time-based One Time Password and push notifications to authenticate users within the second factor authentication scheme.

---

---

**Note:**

Installing Oracle Adaptive Access Manager is not required since the Adaptive Authentication Service uses a set of libraries that makes a OTP step feasible using the Oracle Mobile Authenticator.

---

---

The Adaptive Authentication Service has to be licensed and explicitly enabled in order to use it. Once the proper product license is procured you can enable the Adaptive Authentication Service using the Oracle Access Management Console. From the Oracle Access Management Console, the Adaptive Authentication Service can be enabled or disabled from the Available Services link on the Configuration Launch Pad.

---

**See Also:**

- [Available Services of the Common Configuration Section](#)
  - [Understanding the Oracle Access Management Console](#)
  - [Working with the Adaptive Authentication Service](#)
- 

## 35.2 Working with the Adaptive Authentication Service

The Adaptive Authentication Service offers second factor authentication. The second factor can be a One Time Pin (OTP) or an Access Request (or push) Notification. After an initial successful user/password authentication, a Second Factor Authentication page is displayed from which the user selects the preferred method of second factor authentication.

The following options are available:

- OTP from Oracle Mobile Authenticator
- OTP through SMS
- OTP through Email
- Access Request Notification from Oracle Mobile Authenticator

Figure 35-1 shows the Second Factor Authentication page in which the user has selected the OTP Through Email option.

In this case, the user receives the OTP via a configured Email address.

**Figure 35-1** Second Factor Authentication Preferred Method Page



If the selected option is either OTP From Oracle Mobile Authenticator or Access Request Notification from Oracle Mobile Authenticator, the Adaptive Authentication Service works in tandem with the Oracle Mobile Authenticator (OMA), a mobile device app that uses Time-based One Time Password and push notifications to authenticate users within the second factor authentication scheme.

In advance of using the OTP from OMA or Access Request Notification from OMA options, a user must download a supported authenticator app to a mobile device (for example, Oracle Mobile Authenticator to an Apple iPhone) and configure it by clicking a link provided by the Access Manager administrator. (The OMA app is not needed if using the OTP through Email or OTP through SMS options.)

---

**Note:**

You must configure the Oracle Mobile Authenticator mobile device app to retrieve a secret key required to generate a OTP.

See [Generating a Secret Key for the Oracle Mobile Authenticator](#) for information about the secret key.

See [Understanding Oracle Mobile Authenticator Configuration](#) for information on how to configure the OMA.

---

The following topics describe each option and how the Oracle Mobile Authenticator works:

- [Understanding the One Time Password Option](#)
- [Understanding the Access Request \(Push\) Notification Option](#)
- [Using the Oracle Mobile Authenticator with OTP And Access Request](#)

### 35.2.1 Understanding the One Time Password Option

After the successful authentication of initial credentials, the user needs to choose one of the OTP options as a second-factor authentication. Access to the protected resource is provided when the OTP received by the user is entered in the OTP login page.

Let's assume the Adaptive Authentication Service is enabled and configured for second factor authentication. When the user accesses a resource protected by Access Manager, a page is displayed that requests a user name and password. If these initial credentials are authenticated successfully, a Second Factor Authentication Preferred Method Page page is displayed and the user selects from one of the options. In this use case, the user selects one of the OTP options and receives a OTP through SMS/Email or generated and displayed by the OMA app. The user enters the OTP in the OTP login page.

[Figure 35-2](#) shows the OTP login page.

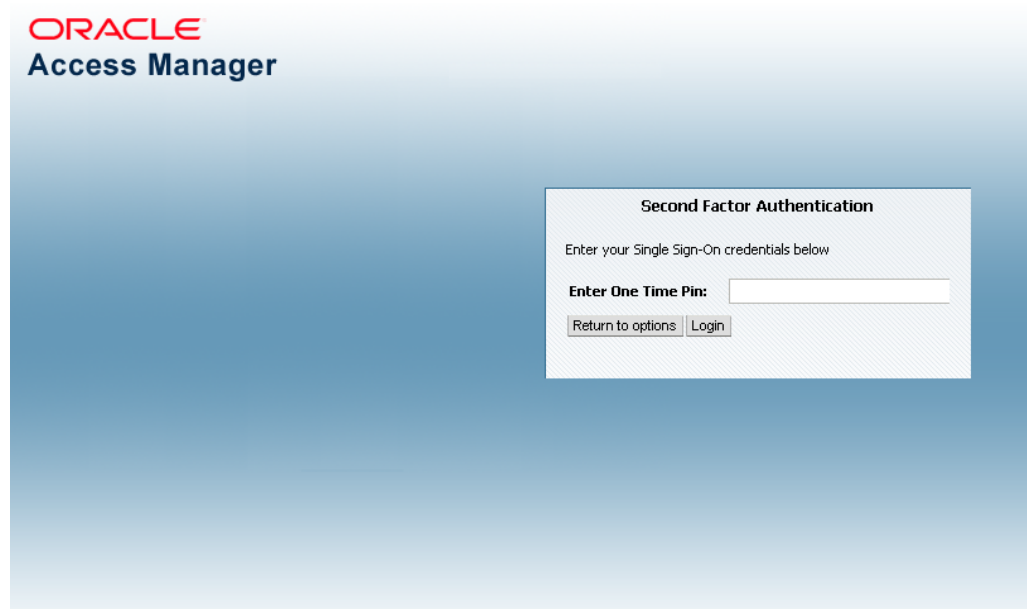
**Figure 35-2 One Time Password Login Page**

Once the OTP is successfully validated by Access Manager, the user is directed to the protected resource. On failure of any of the OTP options, an error message will be displayed, and the user will be returned to the same OTP page.

---

**Note:**

Access Manager validates the OTP using the Time-based One Time Password (TOTP) algorithm. TOTP is a two-factor authentication scheme specified by the Internet Engineering Task Force (IETF) under RFC 6238 and used by the Adaptive Authentication Service. TOTP is an extension of the HMAC-based One Time Password algorithm and supports a time-based *moving factor* (a value that must be changed each time a new password is generated).

---

The following topics describe how the user may receive the OTP:

- [About using OTP through Email or SMS](#)
- [About using OTP from Oracle Mobile Authenticator](#)

### 35.2.1.1 About using OTP through Email or SMS

The user receives the OTP through an email or SMS and enters it in the OTP login page.

In cases where OTP through email or SMS is chosen, Access Manager will send a OTP to the configured email address or phone number respectively. The user then enters the received OTP and Access Manager will validate it. On a successful validation, the user will be directed to the protected resource.

The Adaptive Authentication Service expects that the required email address or phone number is configured in the appropriate field.

See [Configuring the Adaptive Authentication Plug-in in the Oracle Access Management Console](#).

When you use the OTP with Email or SMS option, the OTP is accessible from any device on which the email address can be accessed or from the SMS app that is associated with the specified phone number, respectively.

---

---

**Note:**

The OMA mobile app is not used for the OTP through Email or OTP through SMS options.

---

---

### 35.2.1.2 About using OTP from Oracle Mobile Authenticator

In the use case where a OTP will be generated and displayed by the OMA app on a mobile device, the app must be configured with the Access Manager server details.

Following this configuration, the user authenticates with Access Manager using the proper credentials and Access Manager will return a secret key. This secret key is unique to each user and known only to Access Manager and the OMA. The secret key is used to generate the OTP.

See [Generating a Secret Key for the Oracle Mobile Authenticator](#) on how to populate the secret key with the required data.

After Access Manager generates a OTP for the user using the secret key, the OTP is pushed to the OMA. The user then enters the OTP in the One Time Pin Login Page. If the OTP generated by Access Manager matches the OTP entered by the user, access to the protected resource is allowed. If the OTP entries do not match, access is not allowed.

See [Using the Oracle Mobile Authenticator with OTP And Access Request](#).

---

---

**Note:**

The OMA refreshes the OTP every 30 seconds so the OTP entered by a user is valid only for that period of time.

---

---

## 35.2.2 Understanding the Access Request (Push) Notification Option

The Access Manager sends an Access Request Notification to the notification server which is then pushed to the user's configured device.

Let's assume the Adaptive Authentication Service is enabled and configured for second factor authentication. When the user accesses a resource protected by Access Manager, a page is displayed that requests a user name and password. If these initial credentials are authenticated successfully, a Second Factor Authentication Preferred Method page is displayed and the user selects from one of the options. In this use case, the user selects Access Request Notification from Oracle Mobile Authenticator.

---

---

**Note:**

This is a push notification option which works in tandem with the OMA.

See [Using the Oracle Mobile Authenticator with OTP And Access Request](#).

---

---

[Figure 35-3](#) shows the Second Factor Authentication Preferred Method Page with Access Request Notification that has been selected.

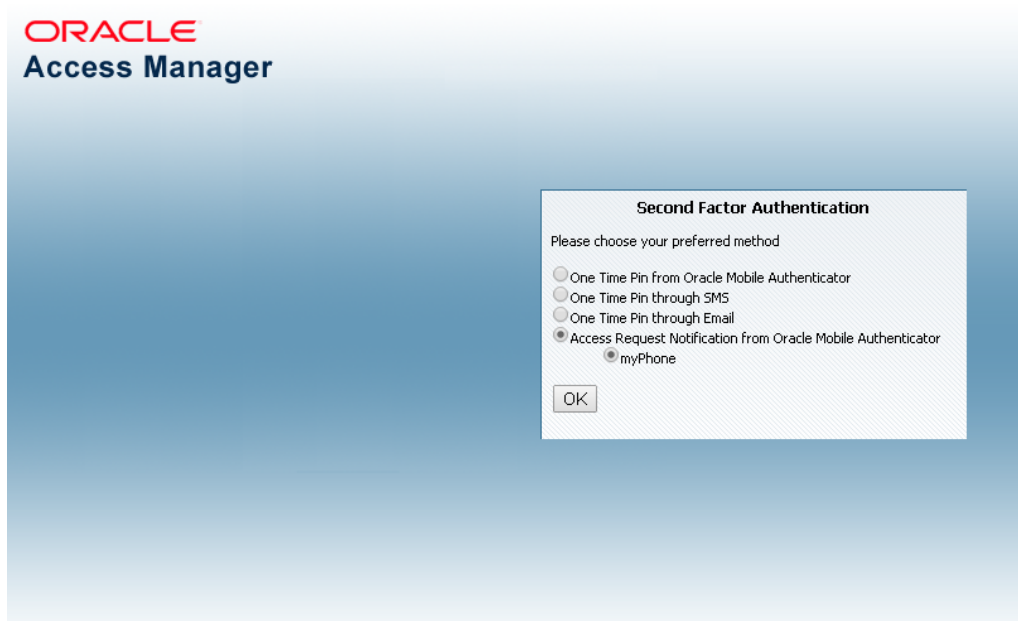
**Figure 35-3 Access Request Notification Preferred Method Page**

When the user selects Access Request Notification from the Second Factor Authentication Preferred Method Page, Access Manager sends an Access Request Notification to either the Apple Push Notification Server or the Google Notification Server depending upon the user's configured device. The notification server then pushes a notification to the mobile device and the user will approve or deny it. Based on a successful response, the user will be directed to the protected resource. On failure, an error message will be displayed and the user will be returned to the same OTP page.

[Figure 35-4](#) shows the Access Request Notification message that is displayed during this process.

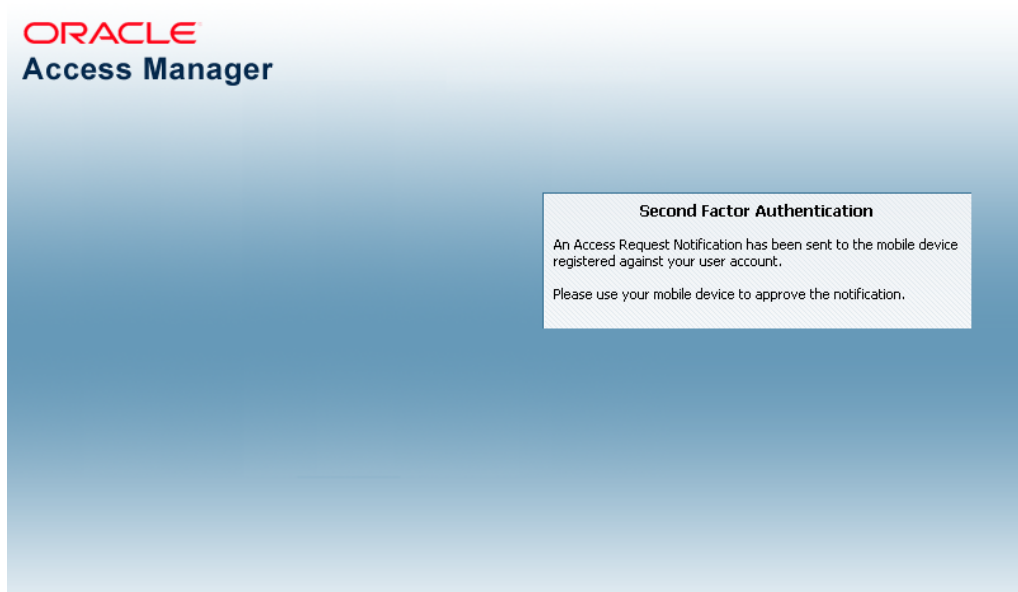
**Figure 35-4 Access Request Notification Wait Screen**

### 35.2.3 Using the Oracle Mobile Authenticator with OTP And Access Request

The user downloads the OMA app to the mobile device and configures it to receive the access request notification.

Depending on the selected option, the Adaptive Authentication Service will need to work in tandem with the Oracle Mobile Authenticator (OMA), a mobile device app that uses Time-based One Time Password and push notifications to authenticate users with the second factor authentication scheme. To receive the OTP or Access Request Notification using the OMA, a user downloads it to an Apple or Android mobile device and configures it by clicking a link provided by the Access Manager administrator. Access Manager and OMA must share a secret key.

See [Generating a Secret Key for the Oracle Mobile Authenticator](#) about the secret key.

See [Understanding Oracle Mobile Authenticator Configuration](#) on how to configure OMA.

---

---

**Note:**

The OMA app is not needed if using the OTP through Email or OTP through SMS options.

See [About using OTP through Email or SMS](#).

---

---

## 35.3 Understanding Adaptive Authentication Service and OMA Configurations

You need to configure the Adaptive Authentication Service and, depending on the option, the OMA.

To configure the Adaptive Authentication Service, perform the following procedures:

- See [Configuring an Adaptive Authentication Service](#).
- See [Understanding Oracle Mobile Authenticator Configuration](#).

## 35.4 Configuring an Adaptive Authentication Service

You can configure an Adaptive Authentication Service if you have already installed Access Manager, a WebGate, and Oracle HTTP Server (OHS).

Some of these configurations are specific to one or the other Adaptive Authentication Service options.

This section describes the following topics:

- [Generating a Secret Key for the Oracle Mobile Authenticator](#)
- [Configuring Mobile OAuth Services to Protect a Secret Key](#)
- [Configuring the Adaptive Authentication Plug-in in the Oracle Access Management Console](#)
- [Setting Credentials for UMS, iOS, and Android](#)
- [Creating a Java KeyStore for iOS Access Request \(Push\) Notifications](#)

- [Configuring Host Name Verifier for Android Access Request \(Push\) Notifications](#)
- [Configuring Access Manager for VPN in a Use Case](#)

### 35.4.1 Generating a Secret Key for the Oracle Mobile Authenticator

A secret key needs to be shared between Access Manager and the OMA app. Businesses can generate secret keys in different ways so the means in which the secret key is generated is not important.

The following RESTful endpoint is used to generate the secret key for a user in the Oracle Access Management identity store.

```
http://<HOST>:<PORT>/ms_oauth/resources/userprofile/secretkey
```

In the case of OMA online configuration (which is Oracle's recommended method of configuration), OMA uses the RESTful endpoint to store the key for a user in the identity store. In the cases of OMA manual configuration or Google Authenticator, the administrator sets up a web application which allows the user to generate a secret key also using above mentioned RESTful endpoint. The secret key is stored as a String in an LDAP attribute in the identity store and the name of this attribute must be passed to the business in the RESTful endpoint configuration before they generate the secret key.

See [Understanding Oracle Mobile Authenticator Configuration](#).

### 35.4.2 Configuring Mobile OAuth Services to Protect a Secret Key

You can enable the Mobile and Social Service and update the User Profile Service in the Oracle Access Management Console to protect the REST Secret Key endpoint by using the Basic Authentication Scheme.

To configure mobile OAuth services to protect a secret key:

1. From the Configuration Launch Pad, click Available Services.
2. Click Enable to enable Mobile and Social, if not already.
3. From the Mobile Security Launch Pad, click Mobile OAuth Services.
4. Click DefaultDomain under Mobile OAuth Identity Domains.
5. From the Resource Servers tab, click UserProfile under User Profile Services.
6. Expand the Resource URIs.
7. From the `/secretkey` tab, expand Attributes.
8. Change the value of `basicauth.allowed` to true.
9. Click Apply.

### 35.4.3 Configuring the Adaptive Authentication Plug-in in the Oracle Access Management Console

Access Manager provides the Adaptive Authentication Plug-in that you can use for two-factor authentication.

To configure the Adaptive Authentication plugin in the Oracle Access Management Console:



1. Log into the Oracle Access Management Console as System Administrator.
2. From the Application Security Launch Pad, click Authentication Plug-ins in the Plug-ins panel.
3. From the Authentication Plug-in tab, type *Adaptive* in the quick search box above the Plug-in Name column and hit Enter.

The AdaptiveAuthenticationPlugin is displayed.

4. Change the properties displayed under Plug-in Details: AdaptiveAuthenticationPlugin as applicable to your environment.

Table 35-1 describes the Adaptive Authentication Plugin properties.

**Table 35-1 Adaptive Authentication Plugin Properties**

| Property               | Description                                                                                                                                                                                                                                                                        | Default Value         | Required for Challenge Method      |
|------------------------|------------------------------------------------------------------------------------------------------------------------------------------------------------------------------------------------------------------------------------------------------------------------------------|-----------------------|------------------------------------|
| IdentityStoreRef       | Identity store name                                                                                                                                                                                                                                                                | UserIdentityStore1    | All                                |
| TotpSecretKeyAttribute | Name of the user attribute in which the secret key is stored.                                                                                                                                                                                                                      | Attribute description | OTP using OMA, Time based OTP      |
| TotpTimeWindow         | The number of OTP codes generated by the mobile device that Access Manager will accept for validation. Since the mobile device generates a new OTP every 30 seconds, if the value is 3, Access Manager will accept the current and last three OTPs generated by the mobile device. | 3                     | OTP using OMA, Time based OTP      |
| PushAPNsProdServer     | If set to true, the APNs production server will be used to send notifications.                                                                                                                                                                                                     | false                 | Access Request Notifications (iOS) |
| PushProxyHost          | Name of the proxy host if notifications are to sent to the server using a proxy.                                                                                                                                                                                                   |                       | Access Request Notifications       |
| PushProxyPort          | Proxy port if notifications are to sent to the server using a proxy.                                                                                                                                                                                                               | 80                    | Access Request Notifications       |
| PushProxyProtocol      | Proxy protocol                                                                                                                                                                                                                                                                     | https://              | Access Request Notifications       |
| UmsAvailable           | When Adaptive Authentication Service requires UMS to send Email and SMS, set to true.                                                                                                                                                                                              | false                 | SMS, Email                         |

**Table 35-1 (Cont.) Adaptive Authentication Plugin Properties**

| Property                                                     | Description                                                                                                                                                                                                                                                                                                                   | Default Value | Required for Challenge Method                                                                                            |
|--------------------------------------------------------------|-------------------------------------------------------------------------------------------------------------------------------------------------------------------------------------------------------------------------------------------------------------------------------------------------------------------------------|---------------|--------------------------------------------------------------------------------------------------------------------------|
| UmsClientUrl                                                 | URL of UMS web service                                                                                                                                                                                                                                                                                                        |               | SMS, Email                                                                                                               |
| PhoneField                                                   | Attribute in the identity store where the user phone number is stored                                                                                                                                                                                                                                                         | mobile        | SMS                                                                                                                      |
| EmailField                                                   | Attribute in the identity store where the user email address is stored                                                                                                                                                                                                                                                        | mail          | Email                                                                                                                    |
| Totp_Enabled<br>Email_Enabled<br>Sms_Enabled<br>Push_Enabled | Controls the options displayed in the UI. If enabled and user is not registered for Push, not setup for TOTP, or doesn't have email/phone populated in id store, those options won't be displayed. For example if user has not registered for TOTP and Push but has email populated then Email will be the only option shown. | true          | NOTE: Properties should be set to false only when the Administrator wants to disable a particular feature for all users. |

5. Click Save.
6. Update the same properties as applicable in the AdaptiveAuthenticationModule by clicking Authentication Modules under Plug-ins in the Access Manager Launch Pad.

From the Authentication Modules tab, search for AdaptiveAuthenticationModule.

[Table 35-1](#) does not list all available Adaptive Authentication Service properties.

#### 35.4.4 Setting Credentials for UMS, iOS, and Android

Use the WLST command line script to set the credentials for the Oracle User Messaging Service (UMS), the iOS certificate or the Android API key.

These credentials are used by the OAM Server in the process of sending SMS/Email and push notifications. [Table 35-2](#) lists information that you need to complete the procedure.

**Table 35-2 Server Side Configuration for Adaptive Authentication Service**

| Configuration                | Information                                                                                                                                                                                                                                                                                                                        | Challenge Method                                    |
|------------------------------|------------------------------------------------------------------------------------------------------------------------------------------------------------------------------------------------------------------------------------------------------------------------------------------------------------------------------------|-----------------------------------------------------|
| iOS Certificate/<br>Password | <a href="https://developer.apple.com/library/mac/documentation/NetworkingInternet/Conceptual/RemoteNotificationsPG/Chapters/ApplePushService.html">https://<br/>developer.apple.com/<br/>library/mac/documentation/<br/>NetworkingInternet/<br/>Conceptual/<br/>RemoteNotificationsPG/<br/>Chapters/<br/>ApplePushService.html</a> | Access Request (Push)<br>notification using iOS     |
| API Key                      | <a href="https://developers.google.com/web/updates/2015/03/push-notifications-on-the-open-web?hl=en">https://<br/>developers.google.com/web/<br/>updates/2015/03/push-<br/>notificatons-on-the-open-<br/>web?hl=en</a>                                                                                                             | Access Request (Push)<br>notification using Android |
| UMS Credential               | UMS credentials that OAM will use to establish the connection to UMS Web service.                                                                                                                                                                                                                                                  | Email/SMS                                           |

To set credentials for UMS, iOS, and AndroidT:

1. `cd <MW_HOME>/oracle_common/common/bin`
2. `./wlst.sh`
3. `connect()`
4. Enter the WebLogic user name and password when prompted.
5. Press Enter to accept the default URL or modify the host and port as necessary and press Enter.
6. Run one or more of the following commands to set credentials for the UMS server, iOS or Android depending on your deployment.

---



---

**Note:**

Replace <UMS SERVER USER NAME>, <UMS SERVER PASSWORD>, <CERTIFICATE STORE PASSWORD> and <API KEY VALUE> with values specific to your environment. Do not change the values for any parameters in these commands but those listed and marked as variables.

---



---

- For OTP for email/SMS only:

```
createCred(map="OAM_CONFIG", key="umsKey", user="<UMS SERVER USER NAME>",
password="<UMS SERVER PASSWORD>")
```

For example:

```
createCred(map="OAM_CONFIG", key="umsKey", user="weblogic",
password="password")
```

- For Access Request (Push) Notifications on iOS only:

```
createCred(map="OAM_CONFIG", key="pushApnsCertKey", user="apnskey",
password="<CERTIFICATE STORE PASSWORD>")
```

For example:

```
createCred(map="OAM_CONFIG", key="pushApnsCertKey", user="apnskey",
password="password")
```

See [Creating a Java KeyStore for iOS Access Request \(Push\) Notifications](#) when using iOS.

- For Access Request (Push) Notifications on Android only:

```
createCred(map="OAM_CONFIG", key="omaApiKey", user="omaApiKey",
password="<API KEY VALUE>")
```

For example:

```
createCred(map="OAM_CONFIG", key="omaApiKey", user="omaApiKey",
password="ADDFGDFGDFGRTERSDFSDFSDFTYERTERTASDASDASD")
```

7. Verify the keys by logging into Fusion Middleware Control, navigating to Domain > Security > Credentials, and checking the OAM\_CONFIG map for the keys input using the commands.

---

---

**Note:**

For information on how to update, delete or otherwise manage credentials using Fusion Middleware Control, see *Securing Applications with Oracle Platform Security Services*.

---

---

### 35.4.5 Creating a Java KeyStore for iOS Access Request (Push) Notifications

When using Access Request Notifications on iOS, create a Java KeyStore (JKS) by using the cert file and key file.

Once the JKS is created, rename it as `APNsCertificate.jks` and put it in the `<domain>/config/fmwconfig` directory of the Oracle Access Management installation. The JKS should contain the user's locally generated private key and the Apple Push Notification service (APNs) certificate downloaded from the Apple Developer Center.

The following sample commands generate and import the certificate:

```
openssl x509 -in aps_production.cer -inform DER -out aps_production.pem
-outform PEM
```

```
openssl pkcs12 -nocerts -in OMAKey.p12 -out OMAKey.pem
```

```
openssl pkcs12 -export -inkey OMAKey.pem -in aps_production.pem
-out iOS_prod.p12
```

```
keytool -import -keystore APNsCertificate.jks -file aps_production.cer
-alias PushCert
```

```
keytool -importkeystore -destkeystore APNsCertificate.jks
-deststoretype JKS -srcstoretype PKCS12 -srckeystore iOS_prod.p12
```

These commands assume:

- `aps_production.cer` to be the name of the APNs certificate downloaded from the Apple Developer Center.
- `OMAKey.p12` is the user's locally generated private key.

Also see [Setting Credentials for UMS, iOS, and Android](#).

---

---

**Note:**

The section *Maintain Your Certificates, Identifiers, and Profiles* at the following Apple URL provides relevant information about app distribution certificates and APNs. <https://developer.apple.com/library/ios/documentation/IDEs/Conceptual/AppDistributionGuide/Introduction/Introduction.html>

---

---

### 35.4.6 Configuring Host Name Verifier for Android Access Request (Push) Notifications

If you are setting up Android for Access Request notification, use the WebLogic console to update the WebLogic Managed Server for host name verification.

This step is required for Access Request notification configuration on Android only. It allows the verification of host names represented using wildcards; for example, `*.googleapis.com`.

To configure host name verifier for Android access requests (push) notifications:

1. Navigate to `base_domain -> Summary of Environment -> Summary of Servers -> oam_server1`.
2. Click the SSL tab.
3. Expand Advanced and select the Hostname verification entry to configure the Hostname Verifier.
4. Enter `weblogic.security.utils.SSLWLSWildcardHostnameVerifier` as the Custom Hostname Verifier.
5. Click Save.
6. Restart the `oam_server1`.

### 35.4.7 Configuring Access Manager for VPN in a Use Case

You can configure Access Manager when a user needs to have access to a protected resource with VPN software.

To configure Access Manager for VPN in a use case:

1. Log into the Oracle Access Management Console as System Administrator.
2. From the Application Security Launch Pad, click Application Domains in the Access Manager panel.

The Application Domain tab is displayed.

3. Click Search to display all available Application Domains.

4. Click the Application Domain name that contains the resource being protected.  
The Application Domain opens in a new tab.
5. Click Authentication Policies in the Application Domain tab.
6. Click the name of the Authentication Policy that is being used to protect the particular resource for which two factor authentication is being configured.  
The appropriate Authentication Policy opens in a new tab.
7. Click Advanced Rules in the Authentication Policy tab.
8. Add a new rule by clicking the plus sign (+) under Post Authentication.  
The Add Rule dialog is displayed.
9. Enter a Rule Name and the following jython script.  

```
location.clientIP.startswith('10.')
```

  
See [Context Data for Advanced Rules](#).
10. Select the AdaptiveAuthenticationScheme Authentication Scheme from the If Condition is True drop-down list.  
This Authentication Scheme will be used when the defined condition is true.
11. Click Add and then Apply to complete the procedure.

---

## Configuring the Oracle Mobile Authenticator

The Oracle Mobile Authenticator is a mobile device app that uses Time-based One Time Password (TOTP) and push notifications to authenticate users with a two-factor authentication scheme. The Oracle Mobile Authenticator mobile device app must be configured to retrieve the secret key required to generate a One Time Password (OTP).

The following sections contain configuration details when using the Oracle Mobile Authenticator app on an iOS or Android mobile device.

- [Understanding Oracle Mobile Authenticator Configuration](#)
- [Using the Oracle Mobile Authenticator App on iOS](#)
- [Using the Oracle Mobile Authenticator App on Android](#)
- [Configuring the Google Authenticator App](#)
- [Using a QR Code for Configuration](#)

### 36.1 Understanding Oracle Mobile Authenticator Configuration

The Oracle Mobile Authenticator (OMA) app can retrieve a secret key required to generate a OTP or register with Access Manager to receive push notifications.

Provisioning the secret key can be done online or offline however registering for push notifications can only be done while online.

---

**Note:**

For details on the secret key, see [Generating a Secret Key for the Oracle Mobile Authenticator](#).

---

- Online Configuration uses the REST web services and the Mobile OAuth Services described in [Generating a Secret Key for the Oracle Mobile Authenticator](#) and [Configuring Mobile OAuth Services to Protect a Secret Key](#). Once enabled, the OMA app can invoke this service to get a secret key or register for push notifications. To invoke the REST web services, OMA needs to know its location URL. In this case, the Oracle Access Management administrator creates a web page to configure the OMA. When the user taps on the web page's link (provided via e-mail), it launches the OMA, passes the location URL to the app and the REST web services location is configured. The format of the location URL is as follows.

```
oraclemobileauthenticator://settings?ServiceName::=<name_of_service>
&ServiceType::=SharedSecret/Notification/Both&
SharedSecretAuthServerType::=HTTPBasicAuthentication/OAuthAuthentication
&LoginURL::=http://<host>:<port>/secretKeyURL
```

```

&NotificationAuthServerType::= HTTPBasicAuthentication
&PushPreferencesEndpoint::=http://<host>:<port>/preferencesURL
&ChallengeAnswerEndpoint::=http://<host>:<port>/challengeAnswerURL
&SenderID::=<senderID>
&OAuthClientID::=<clientID>
&OAMOAuthServiceEndpoint::=http://<host>:<port>/oauthserviceURL
&OAuthScope::=<OAuthScope>

```

Table 36-1 documents definitions for the location URL parameters.

**Table 36-1 Location URL Parameter Definitions**

| Parameter                  | Definition                                                                                                                                                                                                           |
|----------------------------|----------------------------------------------------------------------------------------------------------------------------------------------------------------------------------------------------------------------|
| ServiceName                | Name of the service. This name should be unique in OMA. If another configuration with same name is sent then it will prompt the user to overwrite the previous one                                                   |
| ServiceType                | The type of service provided by this configuration i.e. one-time password, notification or a hybrid service which combines both one-time password and notification. Value can be SharedSecret, Notification or Both. |
| SharedSecretAuthServerType | The type of authentication by which shared secret provisioning REST endpoint is protected. Value can be HTTPBasicAuthentication or OAuthAuthentication.                                                              |
| LoginURL                   | The REST endpoint that provisions the shared secret for generating one-time passwords. The value specified for the LoginURL query parameter is based on the OAuth settings for Oracle Mobile Authenticator.          |
| NotificationAuthServerType | The type of authentication by which notification registration endpoint is protected. Currently only HTTP basic authentication is supported thus the value is HTTPBasicAuthentication.                                |
| PushPreferencesEndpoint    | The REST endpoint where push notification preferences should be sent.                                                                                                                                                |
| ChallengeAnswerEndpoint    | The REST endpoint where push notification responses should be sent.                                                                                                                                                  |
| SenderID                   | The Android sender ID for sending push notifications. The SenderID is only required on Android; it is not required when using iOS.                                                                                   |
| OAuthClientID              | OAuth client ID if SharedSecretAuthServerType is set for OAuth                                                                                                                                                       |
| OAMOAuthServiceEndpoint    | OAM OAuth service endpoint to get OAuth profiles available on the server.                                                                                                                                            |
| OAuthScope                 | The OAuth scope required to access the shared secret.                                                                                                                                                                |

Online configuration details are also documented in [Configuring the Oracle Mobile Authenticator for iOS](#) and [Configuring the Oracle Mobile Authenticator for Android](#). OAuth configuration details are in [Configuring OAuth Services](#).



**Note:**

Oracle recommends using online configuration.

- Offline Configuration supports use cases in which the mobile device can not connect to the REST end point or the parameters needed to generate the OTP are different than the defaults. The Access Manager administrator sets up a web application which allows the user to generate or recreate a secret key. The user logs into this web application and, after authentication, the user is allowed to view the secret key and enter it in the OMA app manually. The secret key can also be delivered via an offline configuration URL so the administrator has the option of changing the OTP generation parameters (time step, hashing algorithm and the like). The format of the offline configuration URL is:

```
oraclemobileauthenticator://settings?SharedSecretValue::=<secret_key>
&AccountName::=<username>&SharedSecretEncoding::=Base32/Base64String
&OTPAlgorithm::=TOTP
&HashingAlgorithm::=MD5/SHA-1/SHA-224/SHA-256/SHA-384/SHA-512
&OTPLength::=<lenght_of_OTP>&TimeStep::=<time_in_seconds>
```

Table 36-2 contains details regarding the parameters.

**Table 36-2 Offline Configuration URL Parameters**

| Parameter            | Description                           |
|----------------------|---------------------------------------|
| SharedSecretValue    | Mandatory value is the secret key     |
| AccountName          | Prompts the user for input if omitted |
| SharedSecretEncoding | Default is Base32                     |
| OTPAlgorithm         | Default is TOTP                       |
| Hashing Algorithm    | Default is SHA-1                      |
| OTPLength            | Default is 6                          |
| TimeStep             | Default is 30 sec                     |

Offline configuration details are also documented in [Configuring Oracle Mobile Authenticator for Offline OTP Generation on iOS](#) and [Configuring Oracle Mobile Authenticator for Offline OTP Generation on Android](#).

## 36.2 Using the Oracle Mobile Authenticator App on iOS

The following sections contain procedures for using OMA on an iOS mobile device.

- [Configuring the Oracle Mobile Authenticator for iOS](#)
- [Initializing the Oracle Mobile Authenticator on iOS](#)
- [Copying a One-Time Password from the Oracle Mobile Authenticator on iOS](#)
- [Editing an Account on the Oracle Mobile Authenticator on iOS](#)
- [Deleting an Account on the Oracle Mobile Authenticator on iOS](#)
- [Responding to Access Request \(Push\) Notifications on iOS](#)

- [Displaying Access Request \(Push\) Notifications History on iOS](#)
- [Displaying Service Account Details on iOS](#)
- [Displaying Access Manager Registered Accounts on iOS](#)
- [Displaying the OMA Version on iOS](#)

### 36.2.1 Configuring the Oracle Mobile Authenticator for iOS

You can configure the OMA on iOS to communicate with Access Manager. A configuration URL is provided by the Access Manager administrator either by e-mail or through a web page.

Details about the URL are in [Understanding Oracle Mobile Authenticator Configuration](#).

1. Tap the configuration URL provided by the Access Manager administrator.

The app will open, display a unique service name to identify this app configuration, and prompt the user to accept the new settings.

2. Tap Accept to apply the settings.

The OMA is configured to communicate with Access Manager.

### 36.2.2 Initializing the Oracle Mobile Authenticator on iOS

The OMA must authenticate and register an account with Access Manager.

Be sure to complete [Configuring the Oracle Mobile Authenticator for iOS](#) before attempting these procedures. Any of the following procedures can be used to initialize the OMA.

- [Initializing the Oracle Mobile Authenticator for OTP Generation on iOS](#)
- [Adding a OTP Generation Account Manually on iOS](#)
- [Initializing Oracle Mobile Authenticator for Access Request \(Push\) Notifications Using Apple Push Notifications](#)
- [Initializing Oracle Mobile Authenticator for Access Request \(Push\) Notifications and OTP Generation on iOS](#)
- [Configuring Oracle Mobile Authenticator for Offline OTP Generation on iOS](#)

#### 36.2.2.1 Initializing the Oracle Mobile Authenticator for OTP Generation on iOS

Once authenticated, the app receives a key from the server that will be used to generate the OTP.

1. Tap the Sign In button.

The login screen will appear.

2. Select the OTP service name for which you are configuring second factor authentication.

This is the unique service name defined in [Configuring the Oracle Mobile Authenticator for iOS](#).

3. Enter your user name and password and tap Submit.

If login is successful, you will be taken to the OTP screen for the newly added account. If login is successful but an account with the same user name for the same service already exists, you will be asked to enter a different user name. Once the user name is unique, you will be taken to the OTP screen.

### 36.2.2.2 Adding a OTP Generation Account Manually on iOS

You can manually configure a OTP account by entering a unique account name and key.

This is the same account that would be created automatically in [Initializing the Oracle Mobile Authenticator for OTP Generation on iOS](#).

1. Tap Enter Provided Key.
2. Enter a unique account name and key.

If the name and key are valid, you will be taken to OTP screen for your new account. If the name is not unique or the key is not valid, you will be prompted to enter the information again.

### 36.2.2.3 Initializing Oracle Mobile Authenticator for Access Request (Push) Notifications Using Apple Push Notifications

The OMA must have the user's consent to receive push notifications. It must also register successfully with the Apple Push Notification Servers and get a unique device token. Afterwards, the OMA can register with Access Manager to receive push notifications.

1. Tap the Sign In button.  
The login screen will appear.
2. Select the Push Notification service name for which you are configuring second factor authentication.

This is the unique service name defined in [Configuring the Oracle Mobile Authenticator for iOS](#).

3. Enter your user name and password and tap Submit.

If authentication and registration is successful, you will be taken to the Accounts page which will display all the accounts that have been configured for Push Notifications.

### 36.2.2.4 Initializing Oracle Mobile Authenticator for Access Request (Push) Notifications and OTP Generation on iOS

The OMA must have the user's consent to receive push notifications. It must also register successfully with the Apple Push Notification Servers and get a unique device token. Afterwards, the OMA can register with Access Manager to receive push notifications.

1. Tap the Sign In button.  
The login screen will appear.

2. Select the service name for which you are configuring second factor authentication.

This is the unique service name defined in [Configuring the Oracle Mobile Authenticator for iOS](#).

3. Enter your user name and password and tap Submit.

If authentication and registration is successful, you will be taken to the OTP screen for the newly added account. If login is successful but a OTP account with the same user name for the same service already exists, you will be asked to enter a different user name. Once the user name is unique you will be taken to the OTP screen. Note that the newly added account will have small globe icon on the top left corner signifying that this account is also configured for push notifications.

### 36.2.2.5 Configuring Oracle Mobile Authenticator for Offline OTP Generation on iOS

The OMA can also be configured with a URL that contains the key used for generating a OTP. This allows for OTP generation when the mobile app is offline.

This configuration URL contains the secret key so it should be delivered on a secure channel.

1. Tap on the offline configuration URL.

This will open the OMA. If there are no OTP accounts configured with the same user name defined by the URL, the account will be added and the user will be taken to the OTP screen. If there are user name conflicts, the user will be prompted to enter a new, unique user name.

2. Enter the displayed OTP in the corresponding login page to complete authentication.

### 36.2.3 Copying a One-Time Password from the Oracle Mobile Authenticator on iOS

You can copy a OTP from the OMA.

1. Tap on the account from which you want to copy the OTP.

The Edit, Copy and Delete icons are displayed.

2. Tap the Copy icon on the left to copy the one-time password to the clipboard.
3. Paste the one-time password in the corresponding login page to complete authentication.

### 36.2.4 Editing an Account on the Oracle Mobile Authenticator on iOS

You can edit an account on the OMA.

1. Tap on the account you want to edit.

The Edit, Copy and Delete icons are displayed.

2. Tap the Edit icon in the middle to edit an account.

A new screen in which you can edit the user name and secret key is displayed.

3. Edit the name and/or key.

4. Tap Update Account to complete the modification.

### 36.2.5 Deleting an Account on the Oracle Mobile Authenticator on iOS

You can delete an account on the OMA.

1. Tap on the account you want to delete.  
The Edit, Copy and Delete icons are displayed.
2. Tap the Delete icon on the right to delete an account.  
You will be prompted for confirmation.
3. Tap Delete to confirm and delete.

### 36.2.6 Responding to Access Request (Push) Notifications on iOS

The OMA can receive push notifications from Access Manager if the push notification option is selected when configuring two factor authentication.

An administrator can use this procedure to respond to the notifications received on the mobile device.

1. Tap the notification alert on the mobile device.  
The OMA app will come to the foreground and display notification details. This includes a user name, the resource being accessed, access time and IP address. A timer depicting how much time you have to respond to this notification is also displayed.
2. Tap Allow or Deny to control access to the resource.  
OMA will send the resource to Access Manager and remove the notification information screen.

### 36.2.7 Displaying Access Request (Push) Notifications History on iOS

You can see the notifications which were received by the OMA and the decision taken for that particular access request.

1. Tap on three dots icon in the top left corner.
2. Tap on Notifications button.  
All the notifications that have been received by Oracle Mobile Authenticator will be shown.
3. Tap on any of the notifications to see the details.

### 36.2.8 Displaying Service Account Details on iOS

You can display the services with which the OMA has been configured.

This corresponds to the unique service name defined in [Configuring the Oracle Mobile Authenticator for iOS](#).

1. Tap the three dots icon in the top left corner.

2. Tap the Configurations button.

All the services that have been configured using this OMA will be displayed.

3. Tap a specific configuration to display the details.

A screen will be displayed that will show all the details of the selected configuration. You can swipe from right to left to delete the configuration.

### 36.2.9 Displaying Access Manager Registered Accounts on iOS

You can see all the accounts that are added to the OMA and check the account type (OTP, notification or a combination of both).

This corresponds to accounts configured using one of the procedures in [Initializing the Oracle Mobile Authenticator on iOS](#).

1. Tap the three dots icon in the top left corner.

2. Tap the Accounts button.

All the accounts that currently exist in the OMA will be displayed. Swipe from right to left to delete any account.

### 36.2.10 Displaying the OMA Version on iOS

You can display the version number of the OMA running on your mobile device.

1. Tap the three dots icon in the top left corner.

2. Tap the About button.

An alert will display the OMA version.

## 36.3 Using the Oracle Mobile Authenticator App on Android

The following sections contain procedures for using OMA on an Android mobile device.

- [Configuring the Oracle Mobile Authenticator for Android](#)
- [Initializing the Oracle Mobile Authenticator on Android](#)
- [Copying a One-Time Password from the Oracle Mobile Authenticator on Android](#)
- [Editing an Account on the Oracle Mobile Authenticator on Android](#)
- [Deleting an Account on the Oracle Mobile Authenticator on Android](#)
- [Responding to Access Request \(Push\) Notifications on Android](#)
- [Displaying Access Request \(Push\) Notifications History on Android](#)
- [Displaying Service Account Details on Android](#)
- [Displaying Access Manager Registered Accounts on Android](#)
- [Displaying the OMA Version on Android](#)

### 36.3.1 Configuring the Oracle Mobile Authenticator for Android

This procedure configures the OMA on Android to communicate with Access Manager. A configuration URL is provided by the Access Manager administrator either by e-mail or through a web page. Details about the URL are in [Understanding Oracle Mobile Authenticator Configuration](#).

1. Tap the configuration URL provided by the Access Manager administrator.

The app will open, display a unique service name to identify this app configuration, and prompt the user to accept the new settings.

2. Tap Accept to apply the settings.

The OMA is configured to communicate with Access Manager.

### 36.3.2 Initializing the Oracle Mobile Authenticator on Android

The OMA must authenticate and register an account with Access Manager. Be sure to complete [Configuring the Oracle Mobile Authenticator for Android](#) before attempting these procedures. Any of the following procedures can be used to initialize the OMA.

- [Initializing the Oracle Mobile Authenticator for OTP Generation on Android](#)
- [Adding a OTP Generation Account Manually on Android](#)
- [Initializing Oracle Mobile Authenticator for Access Request \(Push\) Notifications Using Google Cloud Messaging](#)
- [Initializing Oracle Mobile Authenticator for Access Request \(Push\) Notifications and OTP Generation on Android](#)
- [Configuring Oracle Mobile Authenticator for Offline OTP Generation on Android](#)

#### 36.3.2.1 Initializing the Oracle Mobile Authenticator for OTP Generation on Android

Once authenticated, the app receives a key from the server that will be used to generate the OTP.

1. Tap the Sign In button.

The login screen will appear.

2. Select the service name for which you are configuring second factor authentication.

This is the unique service name defined in [Configuring the Oracle Mobile Authenticator for Android](#).

3. Enter your user name and password and tap Submit.

If login is successful, you will be taken to the OTP screen for the newly added account. If login is successful but an account with the same user name for the same service already exists, you will be asked to enter a different user name. Once the user name is unique, you will be taken to the OTP screen.

### 36.3.2.2 Adding a OTP Generation Account Manually on Android

You can manually configure a OTP account by entering a unique account name and key. This is the same account that would be created automatically in [Initializing the Oracle Mobile Authenticator for OTP Generation on Android](#).

1. Tap Enter Provided Key.
2. Enter a unique account name and key.

If the name and key are valid, you will be taken to OTP screen for your new account. If the name is not unique or the key is not valid, you will be prompted to enter the information again.

### 36.3.2.3 Initializing Oracle Mobile Authenticator for Access Request (Push) Notifications Using Google Cloud Messaging

The OMA must register successfully with the Google Cloud Messaging (Push Notification) servers and get a unique registration token. This registration token is sent to Access Manager to complete the push notification setup. Once complete, the OMA can register with Access Manager to receive push notifications.

1. Tap the Sign In button.  
The login screen will appear.
2. Select the service name for which you are configuring second factor authentication.

This is the unique service name defined in [Configuring the Oracle Mobile Authenticator for Android](#).

3. Enter your user name and password and tap Submit.

If authentication and registration is successful, you will be taken to the Accounts page which will display all the accounts that have been configured for Push Notifications.

### 36.3.2.4 Initializing Oracle Mobile Authenticator for Access Request (Push) Notifications and OTP Generation on Android

The OMA must register successfully with the Google Cloud Messaging (Push Notification) Servers and get a unique registration token. This registration token is sent to Access Manager to complete the push notification setup. Afterwards, the OMA can register with Access Manager to receive push notifications.

1. Tap the Sign In button.  
The login screen will appear.
2. Select the service name for which you are configuring second factor authentication.

This is the unique service name defined in [Configuring the Oracle Mobile Authenticator for Android](#).

3. Enter your user name and password and tap Submit.

If authentication and registration is successful, you will be taken to the OTP screen for the newly added account. If login is successful but a OTP account with the same user name for the same service already exists, you will be asked to enter a different



user name. Once the user name is unique you will be taken to the OTP screen. Note that the newly added account will have small globe icon on the top left corner signifying that this account is also configured for push notifications.

### **36.3.2.5 Configuring Oracle Mobile Authenticator for Offline OTP Generation on Android**

The OMA can also be configured with a URL that contains the key used for generating a OTP. This allows for OTP generation when the mobile app is offline. This configuration URL contains the secret key so it should be delivered on a secure channel.

1. Tap on the offline configuration URL.

This will open the OMA. If there are no OTP accounts configured with the same service name defined by the URL, the account will be added and user will be taken to the OTP screen. If there are user name conflicts, the user will be prompted to enter a new, unique service name.

2. Enter the displayed OTP in the corresponding login page to complete authentication.

### **36.3.3 Copying a One-Time Password from the Oracle Mobile Authenticator on Android**

Use this procedure to copy a OTP from the OMA.

1. Long press on the account from which you want to copy the OTP.

Three icons are displayed in the top/ action bar.

2. Tap the Copy icon on the left to copy the one-time password to the clipboard.
3. Paste the one-time password in the corresponding login page to complete authentication.

### **36.3.4 Editing an Account on the Oracle Mobile Authenticator on Android**

Use this procedure to edit an account on the OMA.

1. Long press on the account you want to edit.

Three icons are displayed in the top/ action bar.

2. Tap the Edit icon in the middle to edit an account.

A new screen in which you can edit the user name and secret key is displayed.

3. Edit the name and/or key.
4. Tap Save to complete the modification.

### **36.3.5 Deleting an Account on the Oracle Mobile Authenticator on Android**

Use this procedure to delete an account on the OMA.

1. Long press on the account you want to delete.

Three icons are displayed in the top/ action bar.

2. Tap the Delete icon on the right to delete an account.  
You will be prompted for confirmation.
3. Tap Delete to confirm and delete.

### 36.3.6 Responding to Access Request (Push) Notifications on Android

The OMA can receive push notifications from Access Manager if the push notification option is selected when configuring two factor authentication. An administrator can use this procedure to respond to the notifications received on the mobile device.

1. Tap the notification alert on the mobile device.

The OMA app will come to the foreground and display notification details. This includes a user name, the resource being accessed, access time and IP address. A timer depicting how much time you have to respond to this notification is also displayed.

2. Tap Allow or Deny to control access to the resource.

OMA will send the resource to Access Manager and remove the notification information screen.

### 36.3.7 Displaying Access Request (Push) Notifications History on Android

You can see the notifications which were received by the OMA and the decision taken for that particular access request.

1. Tap on menu in the action bar.
2. Tap on the Notifications menu item.

All the notifications that have been received by Oracle Mobile Authenticator will be shown.

3. Tap on any of the notifications to see the details.

### 36.3.8 Displaying Service Account Details on Android

You can display the services with which the OMA has been configured. This corresponds to the unique service name defined in [Configuring the Oracle Mobile Authenticator for Android](#).

1. Tap on menu in the action bar.
2. Tap the Configurations menu item.

All the services that have been configured using this OMA will be displayed.

3. Tap a specific configuration to display the details.

A screen will be displayed that will show all the details of the selected configuration. You can select each configuration to see the details. You can delete a configuration by selecting the delete item from the menu items in the action bar.

### 36.3.9 Displaying Access Manager Registered Accounts on Android

You can see all the accounts that are added to the OMA and check the account type (OTP, notification or a combination of both). This corresponds to accounts configured

using one of the procedures in [Initializing the Oracle Mobile Authenticator on Android](#).

1. Tap on the menu in the action bar.
2. Tap the Accounts menu item.

All the accounts that currently exist in the OMA will be displayed. You can long press on an account to edit or delete it.

### 36.3.10 Displaying the OMA Version on Android

You can display the version number of the OMA running on your mobile device.

1. Tap the menu in the action bar.
2. Tap the About menu item to display the OMA version.

## 36.4 Configuring the Google Authenticator App

The Google Authenticator app only supports manual configuration.

To initiate configuration in the Google Authenticator app, the user creates an account for two-factor authentication using the app. After account creation, the user manually enters the secret key received from the resource owner. (For details on the secret key, see [Generating a Secret Key for the Oracle Mobile Authenticator](#).) Additionally, ensure that TOTP is enabled at the bottom of the Google Authenticator screen. Google Authenticator generates the OTP code in an offline, disconnected mode; it does not interact with Access Manager.

## 36.5 Using a QR Code for Configuration

A Quick Response (QR) code can be used to configure the OMA. The OMA scans the QR code for either online configuration or offline configuration details.

- In the case of online configuration, it gets the URL against which the user will be authenticated and registers the OMA app for said user. After a successful authentication and registration, the OMA gets the shared secret from the OAM server to generate the TOTP.
- In the case of offline configuration, it is assumed that the customer develops a web application and a user is authenticated by said application. The OMA scans the QR code which must have the shared secret, shared secret encoding information and optionally the OTP validity duration, the hashing algorithm to be used for TOTP or the length of the OTP (5 digits/6 digits).

The QR code needs to be created from any of the following configuration URLs.

- `oraclemobileauthenticator://settings?LoginURL::=http://OAMhost:port/ms_oauth/resources/userprofile/secretkey`
- `oraclemobileauthenticator://settings?AuthServerType::=HTTPBasicAuthentication&&LoginURL::=http://OAMhost:port/ms_oauth/resources/userprofile/secretkey&&ServiceName::=MyBank`
- `oraclemobileauthenticator://settings?AuthServerType::=OAuthAuthentication&&LoginURL::=http://OAMhost:port/ms_oauth/resources/userprofile/`

```
secretkey&&ServiceName::=OAuth&&OAuthClientID::=8d91cb4821dd417286ca9
73045e9e25a&&OAMOAuthServiceEndpoint::=http://OAMhost:port/ms_oauth/
oauth2/endpoints/oauthservice
```

The mobile phone user needs to go to the "Add Account" screen and select the "Scan a barcode" option. After positioning the QR code in front of the phone's camera, the OMA app will update its configuration. See "[Understanding Oracle Mobile Authenticator Configuration](#)" for additional configuration URLs.

# Part IX

---

## Managing Oracle Access Management Identity Federation

Oracle Identity Federation enables business partners to achieve a federated environment by providing the mechanism with which companies can form a federation and securely share services and data across their respective security domains.

This section contains the following chapters:

- [Introducing Identity Federation in Oracle Access Management](#)
- [Managing Identity Federation Partners](#)
- [Managing Settings for Identity Federation](#)
- [Managing Federation Schemes and Policies](#)



---

## Introducing Identity Federation in Oracle Access Management

A *federation* is defined as "an association formed by merging several groups or parties". A federated environment (as defined in the identity management realm) is one in which organizations that provide services and identity data (business partners) have established trust in order to share access to a set of protected resources while protecting the same from unauthorized access. Oracle Identity Federation enables business partners to achieve this by providing the mechanism with which companies can form a federation and securely share services and data across their respective security domains.

With the 11g Release 2 (11.1.2.3) of Oracle Access Management, the standalone Oracle Identity Federation product has begun its integration with Oracle Access Manager. This chapter introduces the integrated Identity Federation and includes the following topics

- [Integrating Identity Federation with Access Manager](#)
- [Deploying Identity Federation with Oracle Access Management](#)
- [Understanding How Identity Federation Works](#)
- [Using Identity Federation](#)
- [Initiating Federation SSO](#)
- [Exchanging Identity Federation Data](#)
- [Administering Identity Federation](#)
- [Enabling Identity Federation](#)

### 37.1 Integrating Identity Federation with Access Manager

The Oracle Identity Management framework supports two approaches to cross-domain single sign-on. You cannot mix-and-match these approaches as each stands on its own.

Based on your setup, perform one of the following:

1. Beginning with the 11g Release 2 (11.1.2), the Oracle Access Management Access Manager server (OAM Server) has been integrated with an Oracle Access Management Identity Federation server. All configuration for the Identity Federation server is performed using the Oracle Access Management Console.
2. Previous, separate releases of Oracle Identity Federation (11.1.1) and Oracle Access Manager can still be deployed to provide federation capabilities. Both servers must be configured and managed for this integration. This approach existed in 11g Release 1 (11.1.1) and is still available.

---

---

**Note:**

The topics in this book presume familiarity with federation and how it works. See Introduction to Oracle Identity Federation in the for background and conceptual information. This current document is limited to describing Oracle Identity Federation functionality as it has been integrated with Access Manager in 11g Release 2 (11.1.2.3).

---

---

Benefits of using the new Identity Federation 11g Release 2 (11.1.2.3) server integrated with Access Manager include:

- Eliminating the need to install and maintain separate servers.
- Simplifying post-install configuration of the federation features, particularly when accessing those features through the Oracle Access Management Console.
- Improving the scalability of the two services working together.
- Providing enhanced diagnostics and troubleshooting.

## 37.2 Deploying Identity Federation with Oracle Access Management

From a functional perspective, the components in an 11g Release 2 (11.1.2.3) scenario using the Identity Federation service (when a user attempts to log in to a protected resource using a Web browser) include the Access Manager server, Oracle WebLogic server hosts, and data stores.

- The Access Manager server contains all the components needed to provide access management services in the federated context, including:
  - a credential collector
  - a federation authentication plugin
  - the Identity Federation engine to generate and process assertions
  - a federation data cache
- Oracle WebLogic Server hosts and provides key infrastructure services, including:
  - the authorization engine, which interacts with Oracle Entitlement Server
  - federation data including circle of trust details and other configuration
  - the Coherence map store
- Data stores, including the identity store and Coherence database, maintain the identity data needed for authentication tasks. Identity Federation supports the Access Manager common user store and provides multiple identity store support. Federation data for persistent account linking can be stored in a database.

---

---

**Note:**

Calls are routine HTTP calls.

---

---



## 37.3 Understanding How Identity Federation Works

A federation can comprise any number of identity providers and service providers. An instance of Identity Federation in a federated network can serve as either an identity provider, a service provider, or both.

One common federated network topology is referred to as the hub-and-spoke model. In this topology, there is either a single service provider accepting authentication from multiple identity providers, or a single identity provider authenticating users for multiple service providers.

- A service provider (SP) is a commercial or not-for-profit organization that offers a web-based service such as a news portal, a financial repository, or retail outlet. When configured as the SP in a federated network and a user wants to access a resource protected by an authentication engine such as Oracle Access Manager, Identity Federation redirects the user to an IdP for global authentication. The IdP will obtain credentials, authenticate the user, and redirect the user back to the Identity Federation server instance - which retrieves the asserted identity from the IdP and redirects the authenticated user to the authentication engine which provides access to the protected resource.
- An identity provider (IdP) is a service provider that stores identity profiles. (Identity providers might also offer services above and beyond those related to identity profile storage.) When configured as the IdP in a federated network and a user wants to access a protected resource, the resource's SP directs the user to the Identity Federation server instance - which uses the Access Manager authentication engine to obtain credentials and authenticate the user. Following successful authentication, the Identity Federation instance can assert the user's identity to the resource's SP - which then authenticates the user itself and provides access to the requested resource.

The integrated Identity Federation server can operate as an IdP or an SP. See [Managing Identity Federation Partners](#) for information on configuring Identity Federation to operate in one of these provider modes and communicate with remote partners in the federation.

## 37.4 Using Identity Federation

In SP-initiated SSO, the federated SSO process begins when the SP sends an authentication request to the IdP. In IdP-initiated SSO, the IdP sends the SP an unsolicited assertion response (in the absence of an authentication request from the SP). Supported runtime flows in both modes include SSO, Logout (initiated from a remote federation partner or Access Manager protected application) and Attribute Query.

This section describes the following topics:

- [Achieving SSO](#)
- [Logging Out](#)
- [Authorizing](#)
- [Forcing Authentication](#)
- [Indicating a Passive Identity Provider](#)
- [User and Assertion Mapping](#)

- [Platform Dependencies](#)

### 37.4.1 Achieving SSO

When the Identity Federation (acting as an IdP) is performing federated SSO with an SP, the Access Manager server authenticates the user or ensures an authenticated user doesn't need to be challenged due to inactivity.

Additionally, the Access Manager server will check that any requested federation authentication method specified by the SP does not require a challenge based on authentication level. The Authentication Scheme mappings to the authentication methods will determine this. (If the SP does not specify a Federation Authentication Method, the IdP will use the one specified for the SP partner in the `defaultschemeid` property.) See [Initiating Federation SSO](#) for details.

### 37.4.2 Logging Out

With Identity Federation, a logout operation is dissociated from the authentication operation. Logout can be initiated by user the (Access Manager server) or a partner in the federation.

- When initiated by the user accessing the Access Manager Logout service, Access Manager kills the user's Access Manager session and displays a logout page that will instruct the various WebGate agents to remove the user cookies. Access Manager then redirects the user to the Identity Federation Logout service which notifies each partner involved in this session by either redirecting the user with a Logout Request message via HTTP Redirect or HTTP POST or by directly sending a Logout Request message via SOAP. Identity Federation then kills the OIF session and redirects the user to the defined return URL.
- When initiated by the user on a web site from a partner in the federation, the partner redirects the user to the Identity Federation server which marks the user session as logging out. Identity Federation then redirects the user to the Access Manager server which kills the user's Access Manager session. Access Manager then displays a logout page that will instruct the various WebGate agents to remove the user cookies, and redirects the user back to Identity Federation to resume the Federation logout process by notifying each partner involved in this session (except the one who first redirected the user) by either redirecting the user with a Logout Request message via HTTP Redirect or HTTP POST or by directly sending a Logout Request message via SOAP. Identity Federation then kills the OIF session and redirects the user with a Logout Response message to the partner who first redirected the user to the Identity Federation server.

### 37.4.3 Authorizing

When the Identity Federation server acts as an IdP, it has the need to issue an Identity Token to the SP during the Federation SSO operation.

The Identity Token will contain user information as well as session information. By default, the authorization feature is turned off. It can be enabled or disabled using the `configureFedSSOAuthz WLST` command. You also need to create a resource of type `TokenServiceRP` (with the Resource URL set to the SP Partner ID) and a Token Issuance Policy to which the Resource is added. The Token Issuance Policy indicates the conditions under which the token should be issued.

### 37.4.4 Forcing Authentication

SAML 2.0 and OpenID 2.0 provide a way for a SP to indicate during Federation SSO whether the user should be challenged by the IdP, even if a valid user session already exists.

In this case, the SP will send an authentication request with a parameter indicating that the IdP should re-challenge the user or force authentication.

### 37.4.5 Indicating a Passive Identity Provider

SAML 2.0 and OpenID 2.0 provide a way for the SP to indicate during Federation SSO whether the Identity Provider should interact with the user.

In this case, the SP will send an authentication request with a parameter indicating that the IdP should not interact with the user or is passive. The IdP recognizes the parameter and returns to the SP:

- An error if the IdP must interact with the user but cannot because of this parameter.
- A Federation Assertion that indicates whether the user has a valid session.

### 37.4.6 User and Assertion Mapping

In Identity Federation, after a SP validates the SAML assertion created by its IdP partner, it can map the assertion to the local user.

In one of the following ways, Identity Federation maps SAML assertion to the local user:

- By mapping the SAML subject to a user record with a user attribute (for example, `mail`).
- By mapping a SAML Assertion Attribute to a user record with a user attribute (for example, the SAML Assertion Attribute `emailAddress` mapped to `mail`).
- By mapping one or more attributes contained in the SAML assertion's `AttributeStatement` element or the SAML subject with an LDAP query. You must configure both the SAML attribute name and the user attribute to which it is mapped.

### 37.4.7 Platform Dependencies

The architecture leverages the Oracle Fusion Middleware platform for the Credential Store Framework (CSF).

CSF securely stores keystore passwords as well as server credentials such as HTTP Basic Authentication usernames and passwords.

## 37.5 Initiating Federation SSO

Federation SSO process can be initiated when Identity Federation is working as an IdP or SP.

This section describes the following topics:

- [IdP Initiated Federation SSO Service](#)

- [SP Initiated Federation SSO Service](#)

### 37.5.1 IdP Initiated Federation SSO Service

The IdP Initiated Federation SSO Service has three query parameters: `providerid`, `returnurl`, and `acsurl`.

When Identity Federation is working as an IdP, the URL for initiating Federation SSO is:

```
http://public-oam-host:public-oam-port/oamfed/idp/initiatessso
```

The query parameters are:

- `providerid`: name of the SP partner with which to perform Federation SSO or the issuer ID / provider ID of the SP partner with which to perform Federation SSO. (required)
- `returnurl`: the SP URL where the user will be redirected after a successful Federation SSO (optional)
- `acsurl`: the SAML 2.0 Assertion Consumer Service URL where Identity Federation will redirect the user with the SAML 2.0 Assertion. This URL must be declared in the SP SAML 2.0 Metadata. (optional)

#### [Multivalue Attributes in SAML Assertion](#)

##### 37.5.1.1 Multivalue Attributes in SAML Assertion

The default behavior of the feature is, during SSO, IDP sends the Group attributes in comma separated format if the user belongs to multiple groups and `always_send` is set to `true`. As an enhanced behavior, During SSO, IdP sends the Group attributes in separate SAML statements instead of comma separated if the `multivaluegroups` flag is set to `true`.

The following SSO protocols support Multi-Valued Groups SAML Attributes

- SAML 2.0
  - SAML 1.1
1. To enable this feature, OAM configuration should be updated depending on the requirement. The `multivaluegroups` attribute setting is disabled by default and is not present in `oam-config.xml`. The User has to add this setting in `oam-config.xml` using WLST commands and set it to `true` to enable multiple attribute statements for Group attribute.
  2. Add `multivaluegroups` attribute setting to `oam-config.xml` at the Partner level or Partner Profile level or Global level using WLST commands and set it to `true`.

```
<Setting Name="multivaluegroups" Type="xsd:boolean">true</Setting>
```

- Enable or disable the `multivaluegroups` at partner level
 

```
updatePartnerProperty(partnerName="spPartnername",
partnerType="SP",propName="multivaluegroups",propValue="true/false",type="boolean");
```
- Enable or disable the `multivaluegroups` at partner profile level

```
putBooleanProperty("/fedpartnerprofiles/saml20-sp-
partner-profile/multivaluelogroups", "true/false");
```

- Enable or disable the multivaluelogroups at global level

```
putBooleanProperty("/idpglobal/multivaluelogroups", "true/
false");
```

## 37.5.2 SP Initiated Federation SSO Service

The SP Initiated Federation SSO Service has two query parameters: providerid and returnurl.

When Identity Federation is working as an SP, the URL for initiating Federation SSO is:

```
http://public-oam-host:public-oam-port/oamfed/sp/initiatessso
```

The query parameters are:

- providerid: name of the IdP partner with which to perform Federation SSO or the issuer ID / provider ID of the IdP partner with which to perform Federation SSO. (required)
- returnurl: the URL where the user will be redirected after a successful Federation SSO (optional)

## 37.5.3 Attribute Consuming Service

OAM Federation service is enhanced to support standard SAML2v-based interfaces and elements.

This section describes the following topics:

- [Elements of Attribute Consuming Service](#)
- [WLST Commands for Attribute Consuming Service](#)

### 37.5.3.1 Elements Of Attribute Consuming Service

The attribute consuming service includes three elements: AttributeConsumingService, AttributeConsumingServiceIndex, and NameQualifier.

#### AttributeConsumingService

The AttributeConsumingService element is included in the SP metadata. This element contains the following fields:

- ServiceName
- ServiceDescription
- index
- isDefault
- RequestedAttribute contains the following fields:
  - acsIndex

- rqstAttrName

---

**Note:** The `rqstAttrName` field can be any user defined value such as name, fiscal number, email, and so on.

---

- rqstAttrNameFormat
- rqstAttrFriendlyName
- rqstAttrIsRequired

Sample SP metadata:

```
<md:AttributeConsumingService index="1" isDefault="false">
 <md:ServiceName xml:lang="en_US">serviceName</md:ServiceName>
 <md:ServiceDescription xml:lang="en_US">serviceDesc</md:ServiceDescription>
 <md:RequestedAttribute FriendlyName="friendlyName" Name="email"
NameFormat="sample:urn:format" isRequired="true"/>
</md:AttributeConsumingService>

<md:AttributeConsumingService index="1" isDefault="true">
 <md:ServiceName xml:lang="eng">Updated-Service-Name</md:ServiceName>
 <md:ServiceDescription xml:lang="eng">updatedServiceDesc</md:ServiceDescription>
 <md:RequestedAttribute FriendlyName="friendlyName" Name="email"
NameFormat="sample:urn:format" isRequired="true"/>
 <md:RequestedAttribute FriendlyName="" Name="empNum" NameFormat="empFormat1"
isRequired="false"/>
 <md:RequestedAttribute FriendlyName="fname" Name="empFirstName"
NameFormat="firstnameformat1" isRequired="true"/>
</md:AttributeConsumingService>
```

### AttributeConsumingService

The `AttributeConsumingServiceIndex` element is included in the SAML 2.0 authentication request. In the runtime SSO, pass the `attributeconsumingserviceindex` parameter in the SP initiated URL, so that `AttributeConsumingServiceIndex` is displayed in the `authnrequest`.

For example, `http://sp-host:sp-managed-port/oamfed/sp/initiatessso?providerid=http://idp-host:idp-managed-port/oam/fed&returnurl=http://sp-host:webgate-port/cgi-bin/headers.cgi&attributeconsumingserviceindex=1`

Sample authentication request:

```
<?xml version="1.0" encoding="UTF-8" standalone="yes"?>
 <samlp:AuthnRequest xmlns:dsig="http://www.w3.org/2000/09/xmldsig#"
xmlns:enc="http://www.w3.org/2001/04/xmlenc#" xmlns:saml="urn:oasis:names:tc:SAML:
2.0:assertion" xmlns:samlp="urn:oasis:names:tc:SAML:2.0:protocol"
xmlns:x500="urn:oasis:names:tc:SAML:2.0:profiles:attribute:X500" xmlns:xsi="http://
www.w3.org/2001/XMLSchema-instance" ProtocolBinding="urn:oasis:names:tc:SAML:
2.0:bindings:HTTP-POST" AttributeConsumingServiceIndex="1" ID="id-
atMY1jR9Vh7PBcWSjdqmyxIc1JNMSFD-zQld7lf8" Version="2.0"
IssueInstant="2016-09-15T22:32:37Z" Destination="http://slc05ynv.us.oracle.com:21328/
oamfed/idp/samlv20">
 <saml:Issuer Format="urn:oasis:names:tc:SAML:2.0:nameid-
format:entity">http://slc06fcv.us.oracle.com:23768/oam/fed</saml:Issuer>
 <samlp:NameIDPolicy AllowCreate="true"/>
</samlp:AuthnRequest>
```

## NameQualifier

The `NameQualifier` element is included in the `<samlp:issuer>` tag.

Example:

```
<saml:Issuer NameQualifier=" http://spid-sp.it"
Format=" urn:oasis:names:tc:SAML:2.0:nameid format:entity"> SPID-sp-test </
saml:Issuer>
```

By default, `NameQualifier` is set to `false`. You can set `NameQualifier` to `true` in the `oam-config.xml` file using the WLST commands. For more information on WLST commands, see the *WLST Command Reference for WebLogic Server*.

The following table illustrates how to enable or disable the `NameQualifier` element using the WLST commands:

| Action                                                           | WLST Command Examples                                                                                                                                                  |
|------------------------------------------------------------------|------------------------------------------------------------------------------------------------------------------------------------------------------------------------|
| Enable <code>NameQualifier</code> at the partner level.          | <code>updatePartnerProperty(partnerName="idp-partner",partnerType="IDP",propName="samlrequestissuenamequalifier",propValue="http://sample.sp.it",type="string")</code> |
| Enable <code>NameQualifier</code> at the partner profile level.  | <code>putStringProperty("/fedpartnerprofiles/saml20-idp-partner-profile/samlrequestissuenamequalifier","http://profile-sample.it")</code>                              |
| Enable <code>NameQualifier</code> at the global level.           | <code>putStringProperty("/spglobal/samlrequestissuenamequalifier","http://spglobal.it")</code>                                                                         |
| Disable <code>NameQualifier</code> at the partner level.         | <code>deletePartnerProperty(partnerName="idp-partner",partnerType="IDP",propName="samlrequestissuenamequalifier")</code>                                               |
| Disable <code>NameQualifier</code> at the partner profile level. | <code>deleteStringProperty("/fedpartnerprofiles/saml20-idp-partner-profile/samlrequestissuenamequalifier")</code>                                                      |
| Disable <code>NameQualifier</code> at the global level.          | <code>deleteStringProperty("/spglobal/samlrequestissuenamequalifier")</code>                                                                                           |

### 37.5.3.2 WLST Commands For Attribute Consuming Service

Attribute Consuming Service is supported with ten WebLogic Scripting Tool (WLST) commands.

More information in the following sections:

- [getDefaultACS](#)

- [getAllRqstAttrsForACS](#)
- [getAllACS](#)
- [getACS](#)
- [addACS](#)
- [addRqstAttrToACS](#)
- [updateACS](#)
- [updateRqstAttrForACS](#)
- [deleteACS](#)
- [deleteRqstAttrForACS](#)

#### 37.5.3.2.1 getDefaultACS

This command retrieves the default attribute consuming service.

##### Description

The `getDefaultACS` command retrieves the default attribute consuming service.

##### Syntax

```
getDefaultACS()
```

##### **Example 37-1** Example

This example illustrates the use of `getDefaultACS` command.

```
getDefaultACS()
```

#### 37.5.3.2.2 getAllRqstAttrsForACS

This command retrieves the list of requested attributes under specified attribute consuming service, `acsIndex`.

##### Description

The `getAllRqstAttrsForACS` command retrieves the list of requested attributes under the specified attribute consuming service, `acsIndex`.

##### Syntax

```
getAllRqstAttrsForACS(acsIndex)
```

---

| Arguments             | Definition                                            |
|-----------------------|-------------------------------------------------------|
| <code>acsIndex</code> | [Mandatory] Index of the attribute consuming service. |

---

##### **Example 37-2** Example

This example illustrates the use of the `getAllRqstAttrsForACS(acsIndex)` command.

```
getAllRqstAttrsForACS(1)
```



### 37.5.3.2.3 getAllACS

This command retrieves the list of all attribute consuming service configured.

#### Description

The getAllACS command retrieves the list of all attribute consuming service configured.

#### Syntax

```
getAllACS()
```

#### **Example 37-3 Example**

This example illustrates the use of the getAllACS() command.

```
getAllACS()
```

### 37.5.3.2.4 getACS

This command retrieves the specified attribute consuming service, acsIndex.

#### Description

The getACS command retrieves the specified attribute consuming service, acsIndex.

#### Syntax

```
getACS(acsIndex)
```

| Arguments | Definitions                                           |
|-----------|-------------------------------------------------------|
| acsIndex  | [Mandatory] Index of the attribute consuming service. |

#### **Example 37-4 Example**

This example illustrates the use of the getACS(acsIndex) command.

```
getACS(1)
```

### 37.5.3.2.5 addACS

This command creates a new entry of attribute consuming service with acsIndex, serviceName, attributeConsumingIsDefault, rqstAttrName, rqstAttrNameFormat, rqstAttrFriendlyName, rqstAttrIsRequired, and serviceDescription.

#### Description

This command creates a new entry of attribute consuming service with acsIndex, serviceName, attributeConsumingIsDefault, rqstAttrName, rqstAttrNameFormat, rqstAttrFriendlyName, rqstAttrIsRequired, and serviceDescription.

It is mandatory to provide details of at least one requested attribute when you create an attribute consuming service. The <xml:lang> parameter is updated with the server locale automatically.

---



---

**Note:** you must create addACS with acsIndex to execute GET and DELETE WLST commands.

---



---

### Syntax

```
addACS(acIndex, serviceName, rqstAttrName, rqstAttrNameFormat,
rqstAttrFriendlyName="", rqstAttrIsRequired="false", serviceDescription="",
attributeConsumingIsDefault="false")
```

| Arguments                   | Definitions                                                                                              |
|-----------------------------|----------------------------------------------------------------------------------------------------------|
| acsIndex                    | [Mandatory] Specifies the index of the attribute consuming service.                                      |
| serviceName                 | [Mandatory] Specifies the name of the service.                                                           |
| rqstAttrName                | [Mandatory] Specifies the name of the requested attribute.                                               |
| rqstAttrNameFormat          | [Mandatory] Specifies the format of the requested attribute.                                             |
| rqstAttrFriendlyName        | [Optional] Specifies the friendly name of the attribute consuming service.                               |
| rqstAttrIsRequired          | [Optional] Determines if the requested attribute is required. The valid values are true and false.       |
| serviceDescription          | [Optional] Provides the description of the service. The default value is "".                             |
| attributeConsumingIsDefault | [Optional] Accepts the value to set the default attribute consuming service. The default value is false. |

#### Example 37-5 Example

This example illustrates the use of the addACS command.

```
addACS(1, "Updated-Service-Name1", "email", "sample:urn:format",
rqstAttrFriendlyName="", rqstAttrIsRequired="false",
serviceDescription="updatedServiceDesc", attributeConsumingIsDefault="true")
```

#### 37.5.3.2.6 addRqstAttrToACS

This command adds a new requested attribute such as `rqstAttrName`, `rqstAttrNameFormat`, `rqstAttrFriendlyName`, and `rqstAttrIsRequired` under the list of specified attribute consuming service, `acsIndex`.

### Description

The `addRqstAttrToACS` command adds a new requested attribute such as `rqstAttrName`, `rqstAttrNameFormat`, `rqstAttrFriendlyName`, and `rqstAttrIsRequired` under the list of specified attribute consuming service, `acsIndex`.

### Syntax

```
addRqstAttrToACS(acIndex, rqstAttrName, rqstAttrNameFormat,
rqstAttrFriendlyName=None, rqstAttrIsRequired="false"):
```

| Arguments                         | Definitions                                                                                                                   |
|-----------------------------------|-------------------------------------------------------------------------------------------------------------------------------|
| <code>acsIndex</code>             | [Mandatory] Specifies the index of the attribute consuming service.                                                           |
| <code>rqstAttrName</code>         | [Mandatory] Specifies the name of the requested attribute.                                                                    |
| <code>rqstAttrNameFormat</code>   | [Mandatory] Specifies the format of the requested attribute.                                                                  |
| <code>rqstAttrFriendlyName</code> | [Optional] Specifies the friendly name of the attribute consuming service.                                                    |
| <code>rqstAttrIsRequired</code>   | [Optional] Determines if the requested attribute is required. The valid values are <code>true</code> and <code>false</code> . |

### **Example 37-6 Example**

This example illustrates the use of the `addRqstAttrToACS` command.

```
addRqstAttrToACS(1, "empNumber", "empFormat1", rqstAttrFriendlyName=None,
rqstAttrIsRequired="false"):
```

### **37.5.3.2.7 updateACS**

This command updates any or all fields of the specified attribute consuming service, `oldACSIndex`.

### **Description**

The `updateACS` command updates any or all fields (that is, `newServiceName`, `newServiceDescription`, `newAttributeLang`, `newIsDefault`, and `newACSIndex`) of the specified attribute consuming service, `oldACSIndex`.

### **Syntax**

```
updateACS(oldACSIndex, newServiceName=None, newServiceDescription=None,
newAttributeLang=None, newIsDefault=None, newACSIndex=None)
```

| Arguments                          | Definitions                                                                                                                                                                                                |
|------------------------------------|------------------------------------------------------------------------------------------------------------------------------------------------------------------------------------------------------------|
| <code>oldACSIndex</code>           | [Mandatory] Specifies the name of the existing attribute consuming service index.                                                                                                                          |
| <code>newServiceName</code>        | [Optional] Specifies the updated name for the attribute consuming service.                                                                                                                                 |
| <code>newServiceDescription</code> | [Optional] Specifies the updated description of the attribute consuming service.                                                                                                                           |
| <code>newAttributeLang</code>      | [Optional] Specifies the updated "xml:lang" for the attribute consuming service name and description.                                                                                                      |
| <code>newIsDefault</code>          | [Optional] Accepts the values such as <code>true</code> or <code>false</code> to set the new default value to attribute consuming service. The valid values are <code>true</code> and <code>false</code> . |
| <code>newACSIndex</code>           | [Optional] Specifies the name of the new attribute consuming service index.                                                                                                                                |

### **Example 37-7 Example**

This example illustrates the use of the `updateACS` command.

---



---

**Note:** At least one optional parameter is required with `acsIndex` to successfully update the ACS.

---



---

- To update only the `newServiceName` field, use the following command:  

```
updateACS(1, newServiceName="SampleAttributeName");
```
- To update both `newServiceName` and `isdefault`, use the following command:  

```
updateACS(1, newServiceName="SampleAttributeName", newIsDefault="true");
```

### 37.5.3.2.8 updateRqstAttrForACS

This command updates all the fields of the specified requested attribute, `oldRqstAttrName` under the specified attribute consuming service, `acsIndex`.

#### Description

The `updateRqstAttrForACS` command updates all the fields of the specified requested attribute, `oldRqstAttrName` under the specified attribute consuming service, `acsIndex`.

#### Syntax

```
updateRqstAttrForACS(acsIndex, oldRqstAttrName, newRqstAttrName=None,
newRqstAttrFriendlyName=None, newRqstAttrNameFormat=None, newRqstAttrIsRequired=None)
```

| Arguments                            | Definitions                                                                                                                                                        |
|--------------------------------------|--------------------------------------------------------------------------------------------------------------------------------------------------------------------|
| <code>acsIndex</code>                | [Mandatory] Specifies the index of the attribute consuming service.                                                                                                |
| <code>oldRqstAttrName</code>         | [Mandatory] Specifies the name of the existing requested attribute that updates the fields.                                                                        |
| <code>newRqstAttrName</code>         | [Optional] Specifies the updated name of the requested attribute.                                                                                                  |
| <code>newRqstAttrFriendlyName</code> | [Optional] Specifies the updated friendly name of the requested attribute.                                                                                         |
| <code>newRqstAttrNameFormat</code>   | [Optional] Specifies the updated format of the requested attribute name.                                                                                           |
| <code>newRqstAttrIsRequired</code>   | [Optional] Determines if the requested attribute is required from the attribute consuming service. The valid values are <code>true</code> and <code>false</code> . |

#### Example 37-8 Example

This example illustrates the use of the `updateRqstAttrForACS` command.

---



---

**Note:** At least one optional parameter is required with `acsIndex` to successfully update the specified requested attribute.

---



---

- To update only `newRqstAttrName`, use the following command:

```
updateRqstAttrForACS(acsIndex, oldRqstAttrName,
newRqstAttrName="SAMPLE_RQST_ATTR");
```

- To update `newRqstAttrName` and `newRqstAttrNameFormat` of the requested attribute, use the following command:

```
updateRqstAttrForACS(acsIndex, oldRqstAttrName,
newRqstAttrName="SAMPLE_RQST_ATTR", newRqstAttrNameFormat="urn:oasis:sample");
```

### 37.5.3.2.9 deleteACS

This command deletes the specified attribute consuming service, `acsIndex`.

#### Description

The `deleteACS` command deletes the specified attribute consuming service, `acsIndex`.

#### Syntax

```
deleteACS(acsIndex)
```

| Arguments             | Definition                                                          |
|-----------------------|---------------------------------------------------------------------|
| <code>acsIndex</code> | [Mandatory] Specifies the index of the attribute consuming service. |

#### **Example 37-9** Example

This example illustrates the use of the `deleteACS` command.

```
deleteACS(1)
```

### 37.5.3.2.10 deleteRqstAttrForACS

This command deletes the requested attribute, `rqstAttrName`, from the specified Attribute Consuming Service, `acsIndex`.

#### Description

The `deleteRqstAttrForACS` command deletes the requested attribute, `rqstAttrName`, from the specified attribute consuming service, `acsIndex`.

#### Syntax

```
deleteRqstAttrForACS(acsIndex, rqstAttrName)
```

| Arguments                 | Definition                                                          |
|---------------------------|---------------------------------------------------------------------|
| <code>acsIndex</code>     | [Mandatory] Specifies the index of the attribute consuming service. |
| <code>rqstAttrName</code> | [Mandatory] Specifies the name of the requested attribute.          |

#### **Example 37-10** Example

This example illustrates the use of the `deleteRqstAttrForACS` command.

```
deleteRqstAttrForACS(1, rqstAttrName="empFirstName")
```

## 37.6 Exchanging Identity Federation Data

The integrated Identity Federation server supports the transport and receipt of request and response messages using either the Security Access Markup Language (SAML) 2.0 specifications, SAML 1.1, OpenID 2.0 or WS-Federation 1.1.

This section describes the following topics:

- [Using SAML 2.0](#)
- [Using SAML 1.1](#)
- [Using OpenID 2.0](#)
- [Using WS-Federation 1.1](#)

---

---

**Note:**

The specification describing how SAML might be used in a given context is referred to as a SAML profile. The specification describing how a SAML assertion and/or message is conveyed in, or transported over, another protocol is referred to as a SAML Binding.

---

---

### 37.6.1 Using SAML 2.0

SAML uses an eXtensible Markup Language (XML) framework to define a simple request-response protocol in order to achieve interoperability between vendor platforms that provide SAML assertions.

A SAML requester sends a SAML Request element to a responder. Similarly, a SAML responder returns a SAML Response element to the requester. Within the SAML 2.0 protocol, Identity Federation supports the functionality described in the following sections.

- [SAML 2.0 Bindings for SSO and Federation](#)
- [SAML 2.0 Bindings for Single Logout](#)
- [SAML 2.0 NameID Formats](#)
- [Securing SAML 2.0 Data](#)
- [SAML 2.0 Service Details](#)

#### 37.6.1.1 SAML 2.0 Bindings for SSO and Federation

SSO and Federation relies on SAML artifacts and assertions to relay authentication information.

The following bindings are supported for the exchange of data regarding SSO and federation.

- The HTTP Artifact Binding uses the Artifact Resolution Protocol and the SAML SOAP Binding (over HTTP) to resolve a SAML message by reference. The IdP will store the Assertion in its repository and redirect the user to the SP with a string (artifact) that references the stored Assertion. The SP will retrieve the Assertion by connecting to the IdP directly over SOAP/HTTP and presenting the artifact

- The HTTP POST Binding relies on an HTML form to communicate authentication information between providers. For example, the service provider may use HTTP Redirect to send a request while the identity provider uses HTTP POST to transmit the response. The IdP can also redirect the user to the SP in an HTML FORM that contains the Assertion itself.
- The Reverse SOAP binding (PAOS) is only supported when Access Manager is configured as an IdP. In this flow, the client sends a SOAP request containing a SAML 2.0 Authn Request message to the IdP. The IdP authenticates the user locally, and returns a SOAP response containing a SAML 2.0 Assertion. The client then presents the results to the remote SP.

### 37.6.1.2 SAML 2.0 Bindings for Single Logout

Single Logout defines how providers notify each other of logout events. This message exchange terminates all sessions when a logout occurs at the SP or IdP.

The following profiles are supported for exchanging data regarding single logout.

- The HTTP Redirect profile relies on HTTP redirects between providers. For example, the IdP redirects the user to the SP using a 302 redirect operation with the URL containing the Logout Request/Response message. This profile can be used for sending and receiving data regarding single logout.
- The HTTP POST profile occurs when the IdP redirects the user to the SP using an HTML FORM containing the Logout Request/Response message. This profile can be used for sending and receiving data regarding single logout.
- The SOAP Binding Profile allows the IdP to connect directly with the SP and send a Logout Request message. During logout, the IdP redirects the user to the various SPs in a sequential manner. The SP will respond with a Logout Response message. This profile relies on asynchronous SOAP over HTTP messaging calls between providers and can be used only for sending data regarding single logout.

### 37.6.1.3 SAML 2.0 NameID Formats

The Name Identifier Mapping defines how an SP can obtain name identifiers assigned to a principal that has authenticated in the name space of a different SP.

When a principal authenticated to one SP requests access to a second site, the second SP can use this protocol to obtain the name identifier and communicate with the first SP about the principal - even though no federation for the principal exists between them. The SAML 2.0 NameID formats listed in [Table 37-1](#) are supported in both IdP and SP mode.

**Table 37-1 Supported SAML 2.0 NameID Formats**

| NameID Format                                             | Description                                                                        |
|-----------------------------------------------------------|------------------------------------------------------------------------------------|
| urn:oasis:names:tc:SAML:1.1:nameid-format:unspecified     | SP/IdP will use the applicable user attribute to populate/process the NameID value |
| urn:oasis:names:tc:SAML:1.1:nameid-format:emailAddress    | SP/IdP will use the applicable user attribute to populate/process the NameID value |
| urn:oasis:names:tc:SAML:1.1:nameid-format:X509SubjectName | SP/IdP will use the applicable user attribute to populate/process the NameID value |

**Table 37-1 (Cont.) Supported SAML 2.0 NameID Formats**

| NameID Format                                                        | Description                                                                                                                                                                                                                                                                                                                                                       |
|----------------------------------------------------------------------|-------------------------------------------------------------------------------------------------------------------------------------------------------------------------------------------------------------------------------------------------------------------------------------------------------------------------------------------------------------------|
| urn:oasis:names:tc:SAML:1.1:nameid-format:WindowsDomainQualifiedName | SP/IdP will use the applicable user attribute to populate/process the NameID value                                                                                                                                                                                                                                                                                |
| urn:oasis:names:tc:SAML:2.0:nameid-format:kerberos                   | SP/IdP will use the applicable user attribute to populate/process the NameID value                                                                                                                                                                                                                                                                                |
| urn:oasis:names:tc:SAML:2.0:nameid-format:persistent                 | SP/IdP will use either: <ul style="list-style-type: none"> <li>• A user attribute to populate the NameID value</li> <li>• A user attribute (such as DN) to set the value (same for every operations)</li> <li>• A random value and will store that value in the Federation Data Store (only this mode will require the use of a Federation Data Store)</li> </ul> |
| urn:oasis:names:tc:SAML:2.0:nameid-format:transient                  | IdP will generate a random value                                                                                                                                                                                                                                                                                                                                  |
| custom value                                                         | When this NameID format is used, OIF/IdP will use a user attribute to populate the NameID value                                                                                                                                                                                                                                                                   |

#### 37.6.1.4 Securing SAML 2.0 Data

Regarding the security of identity data transported using the SAML 2.0 specifications, the following is true.

- All outgoing Assertions will be signed.
- All outgoing responses containing Assertions will not be signed.
- All outgoing requests/responses not containing Assertions will be signed.
- The signing certificate will not be included in the messages.
- Identity Federation (acting as the IdP) will not require signatures on any messages except when specified in the SP Partner metadata.
- NameIDs, attributes and Assertions will not be encrypted.
- Information on the default XML Encryption algorithm is located at <http://www.w3.org/TR/2002/REC-xmlenc-core-20021210/Overview.html#aes128-cbc>
- The hashing algorithm for signatures is SHA-1 by default. Identity Federation can be configured to use SHA-256.

#### 37.6.1.5 SAML 2.0 Service Details

The SAML 2.0 Metadata for the IdP and SP is contained in a single XML document and can be retrieved using the Oracle Access Management Console.

The Metadata can also be retrieved by accessing either of the following URLs:

```
http://public-oam-host:public-oam-port/oamfed/idp/metadata
http://public-oam-host:public-oam-port/oamfed/sp/metadata
```



The certificates used for signature and encryption operations are published via the SAML 2.0 Metadata. The certificates can be retrieved by using a Service URL that specifies the Key ID of the key/certificate entry as defined in the Keystore Settings. (See [Defining Keystore Settings for Federation](#).) For example,

```
http://public-oam-host:public-oam-port/oamfed/idp/cert?id=osts_signing
```

The Provider ID and the Issuer ID of the IdP and SP profiles are identical and can be retrieved from the applicable Provider Partner profile using the Oracle Access Management Console.

[Table 37-2](#) documents the SAML 2.0 URLs for use when Identity Federation is configured to act as an IdP.

**Table 37-2 SAML 2.0 URLs for Identity Federation Acting As Identity Provider**

| Description                                          | URL                                                       |
|------------------------------------------------------|-----------------------------------------------------------|
| Single Sign On Service URL for HTTP Redirect binding | http://public-oam-host:public-oam-port/oamfed/idp/samlv20 |
| Single Sign On Service URL for HTTP POST binding     | http://public-oam-host:public-oam-port/oamfed/idp/samlv20 |
| Single Sign On Service URL for SOAP binding          | http://public-oam-host:public-oam-port/oamfed/idp/soap    |
| Artifact Resolution Service URL for SOAP binding     | http://public-oam-host:public-oam-port/oamfed/idp/soap    |
| Single Logout Service URL for HTTP Redirect binding  | http://public-oam-host:public-oam-port/oamfed/idp/samlv20 |
| Single Logout Service URL for HTTP POST binding      | http://public-oam-host:public-oam-port/oamfed/idp/samlv20 |
| Attribute Authority Service URL for SOAP binding     | http://public-oam-host:public-oam-port/oamfed/aa/soap     |

[Table 37-3](#) documents the SAML 2.0 URLs for use when Identity Federation is configured to act as an SP.

**Table 37-3 SAML 2.0 URLs for Identity Federation Acting as Service Provider**

| Description                                          | URL                                                          |
|------------------------------------------------------|--------------------------------------------------------------|
| Assertion Consumer Service URL for Artifact binding  | http://public-oam-host:public-oam-port/oam/server/fed/sp/sso |
| Assertion Consumer Service URL for HTTP POST binding | http://public-oam-host:public-oam-port/oam/server/fed/sp/sso |
| Single Logout Service URL for HTTP Redirect binding  | http://public-oam-host:public-oam-port/oamfed/sp/samlv20     |
| Single Logout Service URL for HTTP POST binding      | http://public-oam-host:public-oam-port/oamfed/sp/samlv20     |

## 37.6.2 Using SAML 1.1

Although the standards address the same use case, SAML 2.0 and SAML 1.1 get there in different ways. The most important type of SAML 1.1 request is a query.

A SP makes a query directly to an IdP over a secure back channel (using SOAP). Within the SAML 1.1 protocol, Identity Federation supports the features described in the following sections.

- [SAML 1.1 Profiles for Web Browser SSO](#)
- [SAML 1.1 Logout Profile](#)
- [SAML 1.1 NameID Formats](#)
- [About SAML 1.1 Data Security](#)
- [SAML 1.1 Service Details](#)

### 37.6.2.1 SAML 1.1 Profiles for Web Browser SSO

SAML 1.1 profiles rely on pushing SAML artifacts and assertions to an SP to relay authentication information.

The following profiles are supported.

- The Browser/Artifact Profile passes a SAML assertion from the IdP to the SP by reference (through the browser using HTTP Redirect). This artifact is subsequently dereferenced through a back-channel exchange in which the SP retrieves the assertion from the IdP using SAML over SOAP over HTTP.
- The Browser/POST Profile passes an SSO assertion to an SP through the browser using HTTP POST. We say that the identity provider "pushes" the assertion to the service provider.

### 37.6.2.2 SAML 1.1 Logout Profile

The SAML 1.1 specifications do not define a logout profile thus Identity Federation is not able to notify remote partners regarding a user logging out.

### 37.6.2.3 SAML 1.1 NameID Formats

When a principal authenticated to one SP requests access to a second site, the second SP can obtain the name identifier and communicate with the first SP regarding the principal - even though no federation for the principal exists between them.

The SAML 1.1 NameID formats listed in [Table 37-4](#) are supported in both IdP and SP mode.

**Table 37-4 Supported SAML 1.1 NameID Formats**

| NameID Format                                          | Description                                                                        |
|--------------------------------------------------------|------------------------------------------------------------------------------------|
| urn:oasis:names:tc:SAML:1.1:nameid-format:unspecified  | SP/IdP will use the applicable user attribute to populate/process the NameID value |
| urn:oasis:names:tc:SAML:1.1:nameid-format:emailAddress | SP/IdP will use the applicable user attribute to populate/process the NameID value |

**Table 37-4 (Cont.) Supported SAML 1.1 NameID Formats**

| NameID Format                                                        | Description                                                                                     |
|----------------------------------------------------------------------|-------------------------------------------------------------------------------------------------|
| urn:oasis:names:tc:SAML:1.1:nameid-format:X509SubjectName            | SP/IdP will use the applicable user attribute to populate/process the NameID value              |
| urn:oasis:names:tc:SAML:1.1:nameid-format:WindowsDomainQualifiedName | SP/IdP will use the applicable user attribute to populate/process the NameID value              |
| urn:oasis:names:tc:SAML:2.0:nameid-format:kerberos                   | SP/IdP will use the applicable user attribute to populate/process the NameID value              |
| custom value                                                         | When this NameID format is used, OIF/IdP will use a user attribute to populate the NameID value |

### 37.6.2.4 About SAML 1.1 Data Security

Regarding the security of identity data transported using the SAML 1.1 specifications, the following is true.

- All outgoing Assertions will be signed.
- All outgoing responses containing Assertions will not be signed.
- The signing certificate will not be included in the messages.
- Identity Federation (acting as the IdP) will not require signatures on any messages.
- The hashing algorithm for signatures is SHA-1 by default. Identity Federation can be configured to use SHA-256.

### 37.6.2.5 SAML 1.1 Service Details

The certificates used for signature and encryption operations can be retrieved by using a Service URL that specifies the Key ID of the key/certificate entry as defined in the Keystore Settings.

For more information, see [Defining Keystore Settings for Federation](#).

For example,

```
http://public-oam-host:public-oam-port/oamfed/idp/cert?id=osts_signing
```

The Provider ID and the Issuer ID of the IdP and SP profiles are identical and can be retrieved from the applicable Provider Partner profile using the Oracle Access Management Console.

[Table 37-5](#) documents the SAML 1.1 URLs for use when Identity Federation is configured to act as an IdP.

**Table 37-5 SAML 1.1 URLs for Identity Federation Acting As Identity Provider**

| Description                | URL                                                          |
|----------------------------|--------------------------------------------------------------|
| Single Sign On Service URL | http://public-oam-host:public-oam-port/oamfed/idp/samlv11sso |

**Table 37-5 (Cont.) SAML 1.1 URLs for Identity Federation Acting As Identity Provider**

| Description                     | URL                                                       |
|---------------------------------|-----------------------------------------------------------|
| Artifact Resolution Service URL | http://public-oam-host:public-oam-port/oamfed/idp/soapv11 |

Table 37-6 documents the SAML 1.1 URL for use when Identity Federation is configured to act as an SP.

**Table 37-6 SAML 1.1 URL for Identity Federation Acting as Service Provider**

| Description                    | URL                                                          |
|--------------------------------|--------------------------------------------------------------|
| Assertion Consumer Service URL | http://public-oam-host:public-oam-port/oam/server/fed/sp/sso |

### 37.6.3 Using OpenID 2.0

OpenID 2.0 allows users to create accounts with a preferred OpenID IdP and use the account as the basis for signing on to any website that accepts OpenID authentication.

Identity data is communicated through the exchange of an OpenID identifier (a URL or XRI chosen by the end-user) and the IdP provides OpenID authentication. Within the OpenID protocol, Identity Federation supports the functionality described in the following sections.

- [OpenID 2.0 Authentication/SSO](#)
- [OpenID 2.0 Logout](#)
- [OpenID 2.0 NameID Format](#)
- [About OpenID 2.0 Data Security](#)
- [OpenID 2.0 Extensions](#)
- [OpenID 2.0 Service Details](#)

#### 37.6.3.1 OpenID 2.0 Authentication/SSO

OpenID 2.0 allows a user to sign into a new web site using a special OpenID URL. For example, if you have a blog at myblog.com, you might have created the OpenID URL, yourname.myblog.com. Then if you navigate to a second web site that accepts OpenID logins and click on the OpenID button, you can type in the URL and click to log in. The second SP discovers the OpenID IdP URL with this OpenID identifier. When the OpenID IdP redirects the authenticated user to the SP, it includes the OpenID Assertion which contains the result of the operation, the NameID of the user and (optional) attributes.

#### 37.6.3.2 OpenID 2.0 Logout

The OpenID 2.0 specifications do not define a logout profile thus Identity Federation is not able to notify remote partners regarding a user logging out.

### 37.6.3.3 OpenID 2.0 NameID Format

OpenID defines the NameID as being a random string thus Identity Federation will use one of the following as the value for the NameID.

- A hashed user attribute (such as DN)
- A generated, random value that will be stored in the Federation Data Store; this mode requires the use of a Federation Data Store

### 37.6.3.4 About OpenID 2.0 Data Security

Regarding the security of identity data transported using the OpenID 2.0 specifications, the following is true.

- All outgoing Assertions will be signed.
- The default Association Algorithm is HMAC SHA-1.
- The default Session Agreement Algorithm is Diffie-Hellmann SHA-1.

### 37.6.3.5 OpenID 2.0 Extensions

OpenID is an extensible specification. The following extensions are available when using the integrated Identity Federation.

- Attribute Exchange (AX): If enabled, a SP can request attributes to be included in the OpenID Assertion response. The IdP can include the requested attributes or attributes configured to be in the response. (Default: enabled)
- Provider Authentication Policy Extension (PAPE): If enabled, advanced authentication methods can be defined and specified. This might include, for example, a phishing-resistant authentication method or multi-factor authentication. (Default: disabled)
- GSA Level 1: identifier in the OpenID Assertion indicating if this server is compliant with the <http://www.idmanagement.gov/schema/2009/05/icam/openid-trust-level1.pdf> policy. If enabled and if PAPE is enabled, OIF will include this policy in the OpenID response (Default: disabled)
- Level Of Assurance (LOA): identifier in the OpenID Assertion indicating if this server is compliant with the [http://csrc.nist.gov/publications/nistpubs/800-63/SP800-63V1\\_0\\_2.pdf](http://csrc.nist.gov/publications/nistpubs/800-63/SP800-63V1_0_2.pdf) policy. If enabled, OIF/IdP will use the mapping between Level of Assurance and schemeID to determine the value to use for LOA in the OpenID response (see 2.5.2 for more information) (Default: disabled)
- No Private Identifier Information (NoPII): identifier in the OpenID Assertion indicating if this server is compliant with the <http://www.idmanagement.gov/schema/2009/05/icam/no-pii.pdf> policy. Note, if enabled, OIF will not include attributes in the OpenID Assertion
- Persistent Personal Identifier (PPID): identifier in the OpenID Assertion indicating if this server is compliant with the <http://schemas.xmlsoap.org/ws/2005/05/identity/claims/privatepersonalidentifier> policy. If enabled and if PAPE is enabled, OIF will include this policy in the OpenID response (Default: disabled)
- Registration (SReg): extension for attributes in the OpenID Assertion. If enabled, the SP can request attributes to be included in the response, and the IdP can

include requested attributes or attributes configured to be in the response (Default: disabled)

- UI Extension (UIExt): extension for UI. In OIF/IdP, support for this extension is limited to advertisement in the XRDS metadata (Default: disabled)

### 37.6.3.6 OpenID 2.0 Service Details

The following URL is the realm of the OpenID 2.0 SP component.

`http://public-oam-host:public-oam-port`

[Table 37-7](#) documents the OpenID 2.0 URLs for use when Identity Federation is configured to act as an IdP.

**Table 37-7 OpenID 2.0 URLs for Identity Federation Acting As Identity Provider**

| Description                | URL                                                                      |
|----------------------------|--------------------------------------------------------------------------|
| Single Sign On Service URL | <code>http://public-oam-host:public-oam-port/oamfed/idp/openidv20</code> |
| Discovery Service URL      | <code>http://public-oam-host:public-oam-port/oamfed/idp/openidv20</code> |

[Table 37-8](#) documents the OpenID 2.0 URLs for use when Identity Federation is configured to act as an SP.

**Table 37-8 OpenID 2.0 URLs for Identity Federation Acting as Service Provider**

| Description                | URL                                                                       |
|----------------------------|---------------------------------------------------------------------------|
| Single Sign On Service URL | <code>http://public-oam-host:public-oam-port/oam/server/fed/sp/sso</code> |
| Discovery Service URL      | <code>http://public-oam-host:public-oam-port/oamfed/sp/openidv20</code>   |
| Realm URL                  | <code>http://public-oam-host:public-oam-port</code>                       |

## 37.6.4 Using WS-Federation 1.1

Access Manager now supports features of the WS-Federation 1.1 protocol.

WS-Federation 1.1 partners can be created using the new `addWSFed11IdPFederationPartner` and `addWSFed11SPFederationPartner` WLST commands. After creating the partners, the profiles can be configured using the existing WLST Identity Federation commands. For details, see the *Oracle Fusion Middleware WebLogic Scripting Tool Command Reference for Identity and Access Management*.

---



---

**Note:**

Partial administration of the WS-Federation 1.1 partners is available using the Oracle Access Management Console.

---



---

## 37.7 Administrating Identity Federation

Identity Federation integrated with Access Manager can be administered with a combination of configurations using the Oracle Access Management Console and Oracle WebLogic Scripting Tool (WLST) commands.

Use the Oracle Access Management Console to enable the Identity Federation service, manage IdP and SP partner profiles, and work with federated authentication schemes and policies. Use the WLST utilities to manage additional server and partner configuration properties.

---



---

**Note:**

Not all WLST command functionality is duplicated in the Oracle Access Management Console and not all console functionality is duplicated on the command line.

---



---

The Oracle Access Management Console enables Administrators to manage configuration related to the federation service and partners. [Table 37-9](#) summarizes the types of information that you can configure for Identity Federation using Oracle Access Management Console.

**Table 37-9 Configuring Identity Federation Settings**

| Configuring ...                                   | Description                                                                                                                                                                                                                                                                                                                                                  |
|---------------------------------------------------|--------------------------------------------------------------------------------------------------------------------------------------------------------------------------------------------------------------------------------------------------------------------------------------------------------------------------------------------------------------|
| Federation Administrators                         | Administrators who can manage federated partners and related configuration.                                                                                                                                                                                                                                                                                  |
| Federation Service                                | Enable and disable the Identity Federation service in Access Manager. See " <a href="#">Enabling Identity Federation</a> ".                                                                                                                                                                                                                                  |
| Federation Settings                               | Manage basic Identity Federation service configuration properties. See <a href="#">Managing Settings for Identity Federation</a> .                                                                                                                                                                                                                           |
| Providers for Federation                          | IdP partners are managed within the context of administering Identity Federation as a SP. Conversely, SP partners are managed within the context of administering Identity Federation as an IdP. See <a href="#">Administering Identity Federation As A Service Provider</a> or <a href="#">Administering Identity Federation As An Identity Provider</a> .. |
| Authentication Schemes and Modules for Federation | Manage federation authentication schemes. See " <a href="#">Using Authentication Schemes and Modules for Identity Federation 11g Release 2 (11.1.2.2)</a> ".                                                                                                                                                                                                 |
| Policies for Use with Federation                  | Manage policies for use with federation partners. See " <a href="#">Managing Access Manager Policies for Use with Identity Federation</a> ".                                                                                                                                                                                                                 |

[Table 37-10](#) outlines the tasks required to implement identity federation using the Oracle Access Management Console.

**Table 37-10 Implementing Identity Federation**

| <b>Task</b>                                                         | <b>Reference</b>                                                        |
|---------------------------------------------------------------------|-------------------------------------------------------------------------|
| Enable the Identity Federation service.                             | <a href="#">Enabling Identity Federation</a>                            |
| Configure federation settings.                                      | <a href="#">Managing General Federation Settings</a>                    |
| Identity IdP and/or SP partners, and configure attributes for them. | <a href="#">Administering Identity Federation As A Service Provider</a> |
| Configure an authentication or authorization policy.                | <a href="#">Managing Federation Schemes and Policies</a>                |
| Protect a resource with this policy.                                | <a href="#">Managing Policies to Protect Resources and Enable SSO</a>   |

## 37.8 Enabling Identity Federation

Identity Federation is an authentication module in Oracle Access Management so both the Access Manager service and Identity Federation must be enabled.

[Figure 37-1](#) illustrates the Available Services page in Oracle Access Management Console with the Access Manager service and Identity Federation already enabled. Use this page to enable (or disable) Identity Federation together with the Access Manager service.

---

---

**Note:**

Once enabled, it is possible to enable or disable specific Federation features such as IdP, SP, Attribute Authority and/or Attribute Requester. Use the `configureFederationService()` WLST command as documented in *WLST Command Reference for WebLogic Server*.















---

---



**Figure 37-1 Available Services Page****Available Services**

The following is the list of services installed in your current deployment. Disabling a service will only turn off that service and will not uninstall it from the system.

| Application Security                                                               |                                 |                                                                                                 |                                                |
|------------------------------------------------------------------------------------|---------------------------------|-------------------------------------------------------------------------------------------------|------------------------------------------------|
|   | Access Manager                  | <br>Enabled  | <input type="button" value="Disable Service"/> |
|   | Adaptive Authentication Service | <br>Enabled  | <input type="button" value="Disable Service"/> |
| Federation                                                                         |                                 |                                                                                                 |                                                |
|   | Identity Federation             | <br>Enabled  | <input type="button" value="Disable Service"/> |
|   | Security Token Service          | <br>Enabled  | <input type="button" value="Disable Service"/> |
|   | Access Portal Service           | <br>Enabled  | <input type="button" value="Disable Service"/> |
| Mobile                                                                             |                                 |                                                                                                 |                                                |
|   | Mobile and Social               | <br>Enabled  | <input type="button" value="Disable Service"/> |
|  | Mobile Security Service         | <br>Enabled | <input type="button" value="Disable Service"/> |

**To enable the Identity Federation service with Access Manager**

1. Log in to the Oracle Access Management Console.

`https://hostname:port/oamconsole/`

2. From the Welcome page, under **Configuration**, click **Available Services**.
3. **Enable Identity Federation:** Click **Enable** beside Identity Federation (or confirm that the green Status check mark displays).

A Confirmation window is displayed.

4. Click OK.
5. **Enable Access Manager:** Click **Enable** beside Access Manager (or confirm that the green Status check mark displays).

A Confirmation window is displayed.

6. Click OK.



---

## Managing Identity Federation Partners

You need to familiarize yourself with the concept of federation partners (service providers and identity providers) in Oracle Access Management Identity Federation.

The following topics describe how to manage identity federation partners:

- [Understanding Federation And Partners](#)
- [Managing Federation Partners](#)
- [Administering Identity Federation As A Service Provider](#)
- [Administering Identity Federation As An Identity Provider](#)
- [Using Attribute Mapping Profiles](#)
- [Mapping Federation Authentication Methods to Access Manager Authentication Schemes](#)
- [Using the Attribute Sharing Plug-in for the Attribute Query Service](#)
- [Using the Federation Proxy](#)
- [Using WLST for Identity Federation Administration](#)
- [Using WLST for Key Transport Algorithm](#)

### 38.1 Understanding Federation And Partners

You must have already familiarized with the federation and partner concepts before you start to manage identity federation partners.

You must have completed the following task:

See [Enabling Identity Federation](#).

The integrated Identity Federation server supports the transport and receipt of request and response messages using either the Security Access Markup Language (SAML) 2.0 specifications, SAML 1.1, OpenID 2.0 or WS-Federation 1.1. Thus, Identity Provider (IdP) and Service Provider (SP) partners can be created with any of these protocols defined. SAML and OpenID partners can be defined using the Oracle Access Management Console. WS-Federation partners can be created using WLST commands.

See [Creating Remote Identity Provider Partners](#).

See [Creating Remote Service Provider Partners](#).

See *Oracle Fusion Middleware WebLogic Scripting Tool Command Reference for Identity and Access Management*.

## 38.2 Managing Federation Partners

This 11g Release 2 (11.1.2.2) of the integrated Identity Federation provides the ability to be configured as a Service Provider (SP) or an Identity Provider (IdP). Following this provider definition, remote providers (whether service or identity) partnered in Federation SSO need to be managed as well. Towards this end, Identity Federation developed the configuration hierarchy concepts of a *partner* and a *partner profile*.

- A *partner profile* refers to settings specific to a partner type (IdP or SP) or a protocol version (SAML 2.0, SAML 1.1, OpenID 2.0). It is a configuration group that represents a sets of common properties that apply to all partners that reference it. It contains mostly secondary configuration objects such as Authentication Method mappings, cryptographic settings (SHA-1 vs SHA-256) and the like.
- A *partner* refers to the configuration for a specific organization partnered in the Federation SSO process. Each partner is associated with a partner profile. The `partnerprofileid` property in a Partner entry defines the partner profile to which this partner is assigned. If the `partnerprofileid` property is not defined, the default Partner Profile for the Partner (based on the Partner type and the Partner protocol) will be used.

All Partners associated with the same Partner Profile will share its defined settings unless they are specifically overridden for a partner at the Partner configuration level. A Partner configuration overrides a Partner Profile configuration which, in turn, overrides a global configuration.

Partner profiles are only manageable using WLST commands. Each new partner created will be bound to one of the default partner profiles listed in [Table 38-1](#). To assign a new partner profile to a partner, use the `setFedPartnerProfile()` WLST command after creating the partner.

See [Using WLST for Identity Federation Administration](#).

**Table 38-1 Default Partner Profiles**

| Default Partner Profile      | Description                                 |
|------------------------------|---------------------------------------------|
| saml20-idp-partner-profile   | SAML 2.0 Partner Profile for IdP partners   |
| saml20-sp-partner-profile    | SAML 2.0 Partner Profile for SP partners    |
| saml11-idp-partner-profile   | SAML 1.1 Partner Profile for IdP partners   |
| saml11-sp-partner-profile    | SAML 1.1 Partner Profile for SP partners    |
| openid20-idp-partner-profile | OpenID 2.0 Partner Profile for IdP partners |
| openid20-sp-partner-profile  | OpenID 2.0 Partner Profile for SP partners  |

## 38.3 Administering Identity Federation As A Service Provider

When the integrated Identity Federation is configured as an SP, you must define any remote IdP partners as trusted by creating and managing profiles that contain details regarding each remote IdP.

To begin administration of the integrated Identity Federation server as an SP, click the Service Provider Administration link under Identity Federation from the Launch Pad in the Oracle Access Management Console. This section provides the following topics.

- [Creating Remote Identity Provider Partners](#)
- [Managing the Remote Identity Provider Partners](#)

### 38.3.1 Creating Remote Identity Provider Partners

Use the New Identity Provider Page to define an identity provider (IdP) partner record for Access Manager. You can specify service details manually or load them from a metadata file.

[Figure 38-1](#) shows the Create Identity Provider Partner page when service details are configured by loading an XML metadata file.

**Figure 38-1 New Identity Provider Page, Service Details Loaded from Metadata**

Create Identity Provider Partner Identity Provider Partner

**General**

Name

Description

Enable Partner

Default Identity Provider Partner

**Service Information**

Protocol

Service Details  Load from provider metadata  Enter Manually

Metadata File  No file selected.

**Mapping Options**

**User Mapping**

User Identity Store

User Search Base DN

Map assertion Name ID to User ID Store attribute

\* Map assertion Name ID to User ID Store attribute

Map assertion attribute to User ID Store attribute

Assertion Attribute

User ID Store Attribute

Map assertion to user record using LDAP query

LDAP Query

**Attribute Mapping**

Attribute Profile

[Figure 38-2](#) shows the Create Identity Provider Partner page when service details are configured by entering values manually.

**Figure 38-2 New Identity Provider Page, Service Details entered Manually**

**Create Identity Provider Partner** Identity Provider Partner Save

**General**

\* Name

Description

Enable Partner

Default Identity Provider Partner

**Service Information**

Protocol

Service Details  Load from provider metadata  Enter Manually

\* Provider ID

Succinct ID

\* SSO Service URL

SOAP Service URL

Logout Request Service URL

Logout Response Service URL

**Signing Certificate**

\* Load Signing Certificate  No file selected.

Load Encryption Certificate  No file selected.

**Mapping Options**

**User Mapping**

User Identity Store

User Search Base DN

Map assertion Name ID to User ID Store attribute

\* Map assertion Name ID to User ID Store attribute

Map assertion attribute to User ID Store attribute

Assertion Attribute

User ID Store Attribute

Map assertion to user record using LDAP query

LDAP Query

**Attribute Mapping**

Attribute Profile

Table 38-2 describes each element on the New Identity Provider page.

**Table 38-2 Identity Provider Partner Settings**

| Element         | Description                                                                                                         |
|-----------------|---------------------------------------------------------------------------------------------------------------------|
| Name            | This is the provider name.                                                                                          |
| Description     | This is a brief description of the provider. (Optional).                                                            |
| Protocol        | This is the provider protocol (SAML 1.1, SAML 2.0 and so on).                                                       |
| Service Details | This drop-down enables you to choose whether to enter service details manually or load from metadata.               |
| Metadata File   | This field appears if loading metadata from a file. Click Browse to select a file to use. Applies to SAML 2.0 only. |

**Table 38-2 (Cont.) Identity Provider Partner Settings**

| <b>Element</b>              | <b>Description</b>                                                                                                                                                                                                                                                  |
|-----------------------------|---------------------------------------------------------------------------------------------------------------------------------------------------------------------------------------------------------------------------------------------------------------------|
| Issuer ID                   | This is the issuer ID of the provider. Applies to SAML 2.0 and SAML 1.1 only.                                                                                                                                                                                       |
| Succinct ID                 | This is the succinct ID of the provider. This element is required if using the artifact profile. Applies to SAML 2.0 and SAML 1.1 only.                                                                                                                             |
| SSO Service URL             | This is the URL address to which SSO requests are sent.                                                                                                                                                                                                             |
| SOAP Service URL            | This is the URL address to which a SOAP service request is sent. This element is required if using artifact profile.                                                                                                                                                |
| Logout Request Service URL  | This is the URL address to which a logout request is sent by the provider. This element is required if using the logout feature. Applies to SAML 2.0 only.                                                                                                          |
| Logout Response Service URL | This is the URL address to which a logout response is sent. This element is required if using the logout feature. Applies to SAML 2.0 only.                                                                                                                         |
| Signing Certificate         | This is the signing certificate used by the provider. You can specify it in <code>pem</code> and <code>der</code> formats. Applies to SAML 2.0 and SAML 1.1 only.                                                                                                   |
| User Identity Store         | This is the identity store in which the IdP's users will be located and mapped. Identity Federation supports multiple identity stores, defined on a per-partner basis. Optionally, if no user identity store is selected, the default Access Manager store is used. |
| User Search Base DN         | This is the base search DN used when looking up user records. (Optional.) If omitted, the default user search base DN configured for the selected user identity store is used.)                                                                                     |

**Table 38-2 (Cont.) Identity Provider Partner Settings**

| Element                          | Description                                                                                                                                                                                                                                                                                                                                                                                                                                                                                                                                                                                                                                                                                                                                                                                                                                                                                                                                                                                                                                                                                                                                                                                                   |
|----------------------------------|---------------------------------------------------------------------------------------------------------------------------------------------------------------------------------------------------------------------------------------------------------------------------------------------------------------------------------------------------------------------------------------------------------------------------------------------------------------------------------------------------------------------------------------------------------------------------------------------------------------------------------------------------------------------------------------------------------------------------------------------------------------------------------------------------------------------------------------------------------------------------------------------------------------------------------------------------------------------------------------------------------------------------------------------------------------------------------------------------------------------------------------------------------------------------------------------------------------|
| Mapping Option                   | <p>This setting indicates how an incoming assertion is mapped to a user in the identity store. Select one of the following:</p> <ul style="list-style-type: none"> <li>Map Assertion Name ID to User ID Store Attribute<br/>Enter the identity store attribute to which the assertion NameID will be mapped.</li> <li>Map Assertion Attribute to User ID Store Attribute<br/>Enter assertion attribute and the identity store attribute to which it will be mapped.</li> <li>Map Assertion to User Record Using LDAP Query<br/>Enter an LDAP query with placeholders for incoming data. You may use: <ul style="list-style-type: none"> <li>- an attribute from the SAML assertion's <code>AttributeStatement</code> element, referenced by its name prefixed and suffixed with the <code>%</code> character</li> <li>- the SAML assertion subject's NameID, referenced by <code>%fed.nameidvalue%</code></li> <li>- the identity provider's partner name, referenced by <code>%fed.partner%</code>.</li> </ul> <p>For example, an LDAP query to map an incoming assertion based on two assertion attributes (lastname and email) would be <code>(&amp;(sn=%lastname%)(mail=%email%))</code>.</p> </li> </ul> |
| Enable Basic HTTP Authentication | Check this box to accept HTTP basic credentials. (Advanced element, available only in provider Edit mode.)                                                                                                                                                                                                                                                                                                                                                                                                                                                                                                                                                                                                                                                                                                                                                                                                                                                                                                                                                                                                                                                                                                    |
| Attribute Mapping Profile        | Indicates the attribute profile to which the partner is bound.                                                                                                                                                                                                                                                                                                                                                                                                                                                                                                                                                                                                                                                                                                                                                                                                                                                                                                                                                                                                                                                                                                                                                |
| Service Details                  | <p>Indicates which of the following options Identity Federation (the RP) uses to perform Federation SSO with the IdP. Applies to OpenID 2.0 only.</p> <ul style="list-style-type: none"> <li>By discovering the IdP SSO URLs via the IdP XRDS metadata available at the Discovery Service URL.</li> <li>By using the specified static OpenID login endpoint which is the IDP SSO service URL.</li> </ul>                                                                                                                                                                                                                                                                                                                                                                                                                                                                                                                                                                                                                                                                                                                                                                                                      |
| Discovery URL                    | Defines the location where the IdP publishes its XRDS metadata. Applies to OpenID 2.0 only.                                                                                                                                                                                                                                                                                                                                                                                                                                                                                                                                                                                                                                                                                                                                                                                                                                                                                                                                                                                                                                                                                                                   |
| Endpoint URL                     | Defines the IdP SSO Service location. Applies to OpenID 2.0 only.                                                                                                                                                                                                                                                                                                                                                                                                                                                                                                                                                                                                                                                                                                                                                                                                                                                                                                                                                                                                                                                                                                                                             |
| Enable Global Logout             | Indicates whether or not Identity Federation should notify the remote partner when the user is signing off during the logout flow. Applies to SAML 2.0 only.                                                                                                                                                                                                                                                                                                                                                                                                                                                                                                                                                                                                                                                                                                                                                                                                                                                                                                                                                                                                                                                  |
| HTTP POST SSO Response Binding   | Indicates whether the SAML Assertion should be sent back from the IdP using the HTTP POST Binding or the Artifact Binding. Applies to SAML 2.0 only.                                                                                                                                                                                                                                                                                                                                                                                                                                                                                                                                                                                                                                                                                                                                                                                                                                                                                                                                                                                                                                                          |



**Table 38-2 (Cont.) Identity Provider Partner Settings**

| Element                              | Description                                                                                                                                                                                                         |
|--------------------------------------|---------------------------------------------------------------------------------------------------------------------------------------------------------------------------------------------------------------------|
| Authentication Request NameID Format | Indicates the NameID format that Identity Federation will request from the IdP during the Federation SSO operation. If none is selected, a NameID format is not specified in the request. Applies to SAML 2.0 only. |

### 38.3.1.1 Defining a New SAML 2.0 Identity Provider for Federation

You can define a new SAML 2.0 identity provider (IdP) for federation.

To create a new identity provider:

1. In the Oracle Access Management Console, click **Federation** at the top of the window.
2. In the Federation console, select **Create Identity Provider Partner** from the **Create (+)** drop-down list in the **Federation** section.
3. In the **Service Details** field, select **Load from provider metadata**. (SAML 2.0 is typically configured with metadata.)
4. A new field named **Metadata File** appears. Click **Browse**.
5. Select the metadata file of interest.
6. The metadata is loaded from the file.
7. Click **Save** to create the Identity Provider definition.

### 38.3.1.2 Defining a New SAML 1.1 Identity Provider for Federation

You can define a new SAML 1.1 identity provider (IdP) for federation.

To create a new identity provider:

1. In the Oracle Access Management Console, click **Federation** at the top of the window.
2. In the Federation console, select **Create Identity Provider Partner** from the **Create (+)** drop-down list in the **Federation** section.
3. In the **Service Details** field, select **Enter Manually**.
4. Fill in the New Identity Provider page using values for your environment (). The information you provide depends on the protocol chosen for the provider and other factors.

See [Table 38-2](#).

5. Click **Save** to create the identity provider definition.

---

---

**Note:**

Some SAML 1.1 configuration parameters are not exposed through the Oracle Access Management Console. The values of these parameters can be modified using the `updatePartnerProperty` WLST command.

See *updatePartnerPropertyWLST Command Reference for WebLogic Server* guide.

---

---

### 38.3.1.3 Defining a New OpenID 2.0 Identity Providers for Federation

In 11g Release 2 (11.1.2.3) the Identity Federation supports OpenID, and acts as an OpenID RP/SP. OpenID Providers can be registered as IdP partners.

Authentication schemes created using these OpenID partners protect Access Manager resources using authentication services provided by the OpenID identity providers.

To define a new OpenID 2.0 identity provider (IdP) for federation:

1. In the Oracle Access Management Console, click **Federation** at the top of the window.
2. In the Federation console, select **Create Identity Provider Partner** from the **Create (+)** drop-down list in the **Federation** section.
3. Fill in the values appropriate for your environment either manually or by uploading a metadata file.  
  
The information you provide depends on the protocol chosen for the provider and other factors.
4. Click **Save** to create the identity provider definition.

#### Google IdP Partners

To add Google as an OpenID 2.0 IdP.

1. In the Oracle Access Management Console, click **Federation** at the top of the window.
2. In the Federation console, select **Create Identity Provider Partner** from the **Create (+)** drop-down list in the **Federation** section.
3. From the Launch Pad, click **Service Provider Administration** under **Identity Federation**.
4. Select **OpenID 2.0** from the **Protocol** drop down menu.
5. Select **Google provider default settings** from the **Service Details** drop down menu.
6. Click **Save** to create the identity provider definition.

The partner is configured so that the SP requests the assertion attributes from the Google IdP and maps them to the corresponding session attribute names:

See [Table 38-3](#).

**Table 38-3 Attributes for Google OpenID Partner**

| Assertion Attribute Name                 | Session Attribute Name |
|------------------------------------------|------------------------|
| http://axschema.org/contact/country/home | country                |
| http://axschema.org/contact/email        | email                  |
| http://axschema.org/namePerson/first     | firstname              |
| http://axschema.org/pref/language        | language               |
| http://axschema.org/namePerson/last      | lastname               |

The Google partner uses `mail` as the user mapping attribute, so that an incoming `http://axschema.org/contact/email` attribute should match the `mail` attribute of the user in the user identity store.

### Yahoo IdP Partners

To add Yahoo as an OpenID 2.0 IdP:

1. In the Oracle Access Management Console, click **Federation** at the top of the window.
2. In the Federation console, select **Create Identity Provider Partner** from the **Create (+)** drop-down list in the **Federation** section.
3. Select OpenID 2.0 from the **Protocol** drop down menu.
4. Select **Yahoo provider default settings** from the **Service Details** drop down menu.
5. Click **Save** to create the identity provider definition.

The partner is configured so that the SP requests the assertion attributes from the Yahoo IdP and maps them to the corresponding session attribute names:

See [Table 38-4](#).

**Table 38-4 Attributes for Yahoo OpenID Partner**

| Assertion Attribute Name                 | Session Attribute Name |
|------------------------------------------|------------------------|
| http://axschema.org/contact/country/home | country                |
| http://axschema.org/contact/email        | email                  |
| http://axschema.org/namePerson/first     | firstname              |
| http://axschema.org/pref/language        | language               |
| http://axschema.org/namePerson/last      | lastname               |

The yahoo partner uses `mail` as the user mapping attribute, so that an incoming `http://axschema.org/contact/email` attribute should match the `mail` attribute of the user in the user identity store.

### 38.3.1.4 Enabling OpenID Simple Registration

By default, Identity federation uses the Attribute Exchange extension to obtain user identity attributes from an OpenID IdP.

However, if you need to use the older Simple Registration (SREG) extension, you can enable it by running the following WLST commands:

```
putBooleanProperty("/spglobal/openid20axenabled", "false")
putBooleanProperty("/spglobal/openid20sregenabled", "true")
```

### 38.3.1.5 Disabling OpenID Simple Registration

You can disable Simple Registration to Attribute Exchange extension.

To switch from the Simple Registration (SREG) extension to the Attribute Exchange extension to obtain user identity attributes from an OpenID IdP:

```
putBooleanProperty("/spglobal/openid20axenabled", "true")
putBooleanProperty("/spglobal/openid20sregenabled", "false")
```

## 38.3.2 Managing the Remote Identity Provider Partners

The following topics describe how to manage an existing IdP for Identity Federation.

- [Searching for Existing Identity Providers](#)
- [Updating Identity Providers for Federation](#)

### 38.3.2.1 Searching for Existing Identity Providers

You can search for existing identity providers from the Federation console.

To search:

1. In the Oracle Access Management Console, click **Federation** at the top of the window.
2. In the Federation console, click **Identity Provider Management** in the **Federation** section.
3. In the Search section of the page, enter appropriate search criteria for identity provider(s). The characters "\*" (asterisk) and "." (period) are supported as search wildcards.

See [Table 38-5](#) for details about the search parameters.

4. Click **Search**.
5. The search results are displayed in a table.

**Table 38-5 Elements Used for IdP Provider Search**

| Element      | Description                           |
|--------------|---------------------------------------|
| Partner Name | Searches for a specific partner name. |
| Provider ID  | Searches by provider ID.              |
| Status       | Searches providers matching a status. |

**Table 38-5 (Cont.) Elements Used for IdP Provider Search**

| Element     | Description                                           |
|-------------|-------------------------------------------------------|
| Description | Searches by provider description.                     |
| Protocol    | Searches for providers that use a specified protocol. |

Table 38-5 describes the parameters by which providers can be searched.

**Figure 38-3 Searching for Identity Providers**

Use the search tool to find your Service Provider partner or register a new partner using the Create Service Provider Partner button.

[+ Create Service Provider Partner](#)

**Search**

Partner Name  Provider ID

Status  Protocol

Description

[Search](#) [Reset](#)

**Search Results**

Actions  View  [+ Create](#) [Duplicate](#) [Edit](#) [Delete](#) [Detach](#)

| Row                 | Partner Name | Status | Provider ID | Protocol | Description |
|---------------------|--------------|--------|-------------|----------|-------------|
| No data to display. |              |        |             |          |             |

Number of Rows

### 38.3.2.2 Updating Identity Providers for Federation

You can search for Identity Providers for Federation and update providers information.

To update Identity Providers for Federation:

1. In the Oracle Access Management Console, click **Federation** at the top of the window.
2. In the Federation console, click **Identity Provider Management** in the **Federation** section.
3. Search for the provider you wish to update.  
See [Searching for Existing Identity Providers](#).
4. Select the provider of interest from the search results table.
5. Click the pencil icon to display the provider update page. The page is divided into sections for: Service Information, Signing Certificates, User Mapping, and Advanced.
6. Update the provider information.  
See [Table 38-2](#) for details.
7. Click **Save** to update the Identity Provider definition.

## 38.4 Administering Identity Federation As An Identity Provider

When the integrated Identity Federation is configured as an IdP, you must define any remote SP partners as trusted by creating and managing profiles that contain details regarding each remote SP.

This section provides the following topics.

- [Creating Remote Service Provider Partners](#)
- [Managing the Remote Service Provider Partners](#)

### 38.4.1 Creating Remote Service Provider Partners

Use the Service Provider Partner page to define a partner profile when Identity Federation is configured as an IdP. You can specify service details manually or load them from a metadata file.

To create remote service provider partners:

1. In the Oracle Access Management Console, click **Federation** at the top of the window.
2. In the Federation console, select **Create Service Provider Partner** from the **Create (+)** drop-down list in the **Federation** section.
3. Enter values for the parameters.

[Table 38-6](#) describes each element on the Create Service Provider page.

**Table 38-6 Service Provider Partner Settings**

| Element                  | Description                                                                                                                                              |
|--------------------------|----------------------------------------------------------------------------------------------------------------------------------------------------------|
| Name                     | This is the provider name.                                                                                                                               |
| Enable Partner           | Select whether this partner is currently participating in the federation.                                                                                |
| Description              | This is a brief description of the provider. (Optional).                                                                                                 |
| Protocol                 | This is the provider protocol (SAML 1.1, SAML 2.0 or OpenID 2.0).                                                                                        |
| Service Details          | Select whether to enter service details manually or load from metadata. If selecting the latter, browse for the metadata file. Applies to SAML 2.0 only. |
| Metadata File            | This field appears if loading metadata from a file. Click Browse to select a file to use. Applies to SAML 2.0 only.                                      |
| Provider ID              | The provider ID or issuer ID of the remote Service Provider. Applies to SAML 2.0 and SAML 1.1 only.                                                      |
| Assertion Consumer URL   | A URL to which Assertion responses are sent. Applies to SAML 2.0 and SAML 1.1 only.                                                                      |
| Load Signing Certificate | Upload the signing certificate used by this SP. Only visible when Enter Manually is selected. Applies to SAML 2.0 and SAML 1.1 only.                     |
| Logout Request URL       | A URL to which logout requests are sent. Applies to SAML 2.0 only.                                                                                       |
| Logout Response URL      | A URL to which responses to logout requests are sent. Applies to SAML 2.0 only.                                                                          |

**Table 38-6 (Cont.) Service Provider Partner Settings**

| Element                     | Description                                                                                                                                                                                                                                                                                  |
|-----------------------------|----------------------------------------------------------------------------------------------------------------------------------------------------------------------------------------------------------------------------------------------------------------------------------------------|
| Load Encryption Certificate | Upload the encryption certificate used by this SP. Only visible when Enter Manually is selected. Applies to SAML 2.0 only.                                                                                                                                                                   |
| NameID Format               | Indicates which NameID format should be used for this SP. Applies to SAML 2.0 and SAML 1.1 only.<br>See <a href="#">Using SAML 2.0</a> .<br>See <a href="#">Using SAML 1.1</a> .                                                                                                             |
| NameID Value                | Indicates how to populate the NameID Value. Applies to SAML 2.0 and SAML 1.1 only. <ul style="list-style-type: none"> <li>• If User ID Store Attribute is selected, specify the user attribute to be used.</li> <li>• If Expression is specified, enter the expression to be used</li> </ul> |
| Attribute Mapping Profile   | Indicates the attribute mapping profile to which the partner is bound. Applies to SAML 2.0 and SAML 1.1 only.                                                                                                                                                                                |
| User Identity Store         | This is the identity store in which the IdP's users will be located and mapped. Identity Federation supports multiple identity stores, defined on a per-partner basis. If no user identity store is selected, the default store defined for Access Manager is used.                          |
| User Search Base DN         | This is the base search DN used when looking up user records. (Optional. If omitted, the default user search base DN configured for the selected user identity store is used.)                                                                                                               |
| Enable Global Logout        | Indicates whether or not OIF should notify the remote partner when the user is signing off, during the logout flow. Applies to SAML 2.0 only.                                                                                                                                                |
| SSO Response Binding        | Indicates whether the SAML Assertion should be sent back from the IdP using the HTTP POST Binding or the Artifact Binding, Applies to SAML 2.0 and SAML 1.1 only.                                                                                                                            |
| Encrypt Assertion           | Indicates whether or not the Assertion should be encrypted for this partner. Applies to SAML 2.0 only.                                                                                                                                                                                       |
| Realm                       | The URL identifying an OpenID SP. Applies to OpenID 2.0 only.                                                                                                                                                                                                                                |
| Endpoint URL                | The URL to which the IdP will redirect the user with the OpenID Assertion. Applies to OpenID 2.0 only.                                                                                                                                                                                       |

4. Click Save to create the remote SP partner profile.

### 38.4.2 Managing the Remote Service Provider Partners

You can edit and manage the profiles of remote SP partners, search for the profile and make changes to the attribute values.

To search for existing service provider partner profiles:

1. In the Oracle Access Management Console, click **Federation** at the top of the window.
2. In the Federation console, click **Service Provider Management** in the **Federation** section.

3. In the **Search** section of the page, enter appropriate search criteria for identity provider(s). The characters "\*" (asterisk) and "." (period) are supported as search wildcards.

See [Table 38-5](#) for details about the search parameters.

4. Click **Search**.
5. Select the appropriate partner in the Search Results table and click **Edit** in the toolbar.

A new tab is activated that displays the partner's attributes. In addition to the attributes.

See [Table 38-6](#) for more information about advanced attributes that you can modify.

- Enable Global Logout
- Encrypt Assertion
- SSO Response Binding (HTTP POST or Artifact)

6. Click **Save** to keep the changes.

---

---

**Note:**

If using SAML 1.1, you can include a certificate in the signature.

See *WLST Command Reference for WebLogic Server*.

---

---

## 38.5 Using Attribute Mapping Profiles

Identity Federation (when configured as an SP) supports the capability to request attributes from an IdP during the Federation process.

To configure for this, map the name of an attribute from the incoming Assertion to a local attribute that will be available in the Access Manager session (`$session.attr.fed.attr.ATTR_NAME`, for example). An IdP Attribute Mapping Profile contains these mappings.

Similarly, Identity Federation (when configured as an IdP) supports including attributes in an SSO Assertion or allowing SP partners to request that attributes be placed in the SSO Assertion. Configuring Identity Federation as an IdP involves setting up an SP Attribute Mapping profile that defines the name of the attribute in the SSO assertion, the expression to be used to populate the attribute value, and whether or not to always send the attribute in the SSO Assertion.

---

---

**Note:**

The protocol used by the provider must support the feature; for example, OpenID 2.0.

---

---

Each partner type (IdP or SP) references an Attribute Mapping Profile that defines the applicable mappings. It indicates how to map attributes for that partner to attributes defined in the Identity Federation server. If a partner does not have an Attribute



Mapping Profile defined, the default Attribute Mapping Profile (based on the partner type) will be used. There is a default Attribute Mapping Profile for each provider type.

- **SP Attribute Mapping Profile:** Each SP partner profile will reference an SP Attribute Mapping Profile. A default SP Attribute Mapping Profile will be used if none is configured.

See [Using the SP Attribute Mapping Profile](#).

- **IdP Attribute Mapping Profile:** Each IdP partner profile will reference an IdP Attribute Mapping Profile. A default IdP Attribute Mapping Profile will be used if none is configured.

See [Using the IdP Attribute Mapping Profile](#).

### 38.5.1 Using the SP Attribute Mapping Profile

When the Identity Federation instance is configured as an IdP, the SP Attribute Mapping Profile allows the administrator to define which message attributes (included in an incoming or outgoing Identity Federation message) map to which Access Manager session attributes.

An expression is used to find the value for the Access Manager attribute when including it in an Assertion or outgoing message. [Table 38-7](#) documents some sample SP attribute mappings.

**Table 38-7 Sample SP Attribute Mappings**

| Message Attribute | Access Manager Session Attribute | Always Send |
|-------------------|----------------------------------|-------------|
| mail              | \$user.attr.mail                 |             |
| firstname         | \$user.attr.givenname            | true        |
| lastname          | \$user.attr.sn                   | true        |
| authn-level       | \$session.authn_level            | true        |

Always Send indicates if the attribute should be sent even when it has not been specifically requested. If an attribute has to be included in an outgoing Assertion irrespective of whether it has been requested, Always Send should be set to true. If Always Send is false, this attribute will not be included in the Assertion unless requested. When an SP sends a request, message attributes are looked up and the mapping value for this message attribute is calculated by evaluating its expression.

---



---

**Note:**

The Value expression will use the OAM Policy Expression Language. More than one message attribute can have the same value expression.

See [Introduction to Policy Responses for SSO](#).

---



---

When you create or modify an SP partner profile ), the available Attribute Mapping Profiles are displayed in a drop-down list. `sp-attribute-profile` is the default profile.

See [Creating Remote Service Provider Partners](#).

Select the default or click the green plus sign to create a custom mapping profile. When creating a new Attribute Mapping for an SP partner, the expressions can be embedded in the value string of the attribute. These expressions are then replaced by their runtime values.

Table 38-8 lists the expressions for the attribute mapping values.

**Table 38-8 Attribute Mapping Value Expressions**

| Value Type                                                                                 | Accepted Values                                                                                                                                                       | Expression                                                                                                                                                      |
|--------------------------------------------------------------------------------------------|-----------------------------------------------------------------------------------------------------------------------------------------------------------------------|-----------------------------------------------------------------------------------------------------------------------------------------------------------------|
| request                                                                                    | httpheader.HTTP_HEADER_NAME                                                                                                                                           | HTTP_HEADER_NAME being the name of an HTTP Header stored as \$request.httpheader.HTTP_HEADER_NAME                                                               |
| request                                                                                    | cookie.COOKIE_NAME                                                                                                                                                    | COOKIE_NAME being the name of a cookie stored as \$request.cookie.COOKIE_NAME                                                                                   |
| request                                                                                    | client_ip                                                                                                                                                             | stored as \$request.client_ip                                                                                                                                   |
| session                                                                                    | authn_level                                                                                                                                                           | stored as \$session.authn_level                                                                                                                                 |
| session                                                                                    | authn_scheme                                                                                                                                                          | stored as \$session.authn_scheme                                                                                                                                |
| session                                                                                    | count                                                                                                                                                                 | stored as \$session.count                                                                                                                                       |
| session                                                                                    | creation                                                                                                                                                              | stored as \$session.creation                                                                                                                                    |
| session                                                                                    | expiration                                                                                                                                                            | stored as \$session.expiration                                                                                                                                  |
| session                                                                                    | attr.ATTR_NAME                                                                                                                                                        | ATTR_NAME being the name of an Access Manager Session Attribute stored as \$session.attr.ATTR_NAME                                                              |
| user                                                                                       | userid                                                                                                                                                                | stored as \$user.userid                                                                                                                                         |
| user                                                                                       | id_domain                                                                                                                                                             | stored as \$user.id_domain                                                                                                                                      |
| user                                                                                       | guid                                                                                                                                                                  | stored as \$user.guid                                                                                                                                           |
| user                                                                                       | groups                                                                                                                                                                | stored as \$user.groups                                                                                                                                         |
| user                                                                                       | attr.ATTR_NAME                                                                                                                                                        | ATTR_NAME being the name of an LDAP User Attribute stored as \$user.attr.ATTR_NAME                                                                              |
| expression<br>(Based on the identifiers defined above and qualified with the type of data) | - request: <ul style="list-style-type: none"> <li>\$request.httpheader.HTTP_HEADER_NAME</li> <li>\$request.cookie.COOKIE_NAME</li> <li>\$request.client_ip</li> </ul> | - <ul style="list-style-type: none"> <li>HTTP_HEADER_NAME being the name of an HTTP Header</li> <li>COOKIE_NAME being the name of a cookie</li> <li></li> </ul> |

**Table 38-8 (Cont.) Attribute Mapping Value Expressions**

| Value Type                                                                                 | Accepted Values                                                                                                                                                                                                                                                                                                                                                                              | Expression                                                                                                                                                                   |
|--------------------------------------------------------------------------------------------|----------------------------------------------------------------------------------------------------------------------------------------------------------------------------------------------------------------------------------------------------------------------------------------------------------------------------------------------------------------------------------------------|------------------------------------------------------------------------------------------------------------------------------------------------------------------------------|
| expression<br>(Based on the identifiers defined above and qualified with the type of data) | - session: <ul style="list-style-type: none"> <li>• \$session.authn_level</li> <li>• \$session.authn_scheme</li> <li>• \$session.count</li> <li>• \$session.creation</li> <li>• \$session.expiration</li> <li>• \$session.attr.ATTR_NAME</li> </ul>                                                                                                                                          | - <ul style="list-style-type: none"> <li>•</li> <li>•</li> <li>•</li> <li>•</li> <li>•</li> <li>• ATTR_NAME being the name of an Access Manager Session Attribute</li> </ul> |
| expression<br>(Based on the identifiers defined above and qualified with the type of data) | - from user: <ul style="list-style-type: none"> <li>• \$user.userid</li> <li>• \$user.id_domain</li> <li>• \$user.guid</li> <li>• \$user.groups</li> <li>• \$user.attr.ATTR_NAME</li> <li>• can be any string, with '.' (dot) characters, spaces characters (like "\$user.userid" or "\$user.attr.givenname \$user.attr.sn" or "This is the number of sessions: \$session.count")</li> </ul> | - <ul style="list-style-type: none"> <li>•</li> <li>•</li> <li>•</li> <li>•</li> <li>•</li> <li>• ATTR_NAME being the name of an LDAP User Attribute</li> <li>•</li> </ul>   |

### 38.5.2 Using the IdP Attribute Mapping Profile

When the Identity Federation instance is configured as an SP, the IdP Attribute Mapping Profile allows the administrator to define which attributes (included in an incoming or outgoing Identity Federation message) map to which Access Manager session attributes.

The profile allows for the inclusion of the following data:

- **Message Attribute:** the name of the attribute in the incoming/outgoing Federation messages.
- **Access Manager Session Attribute:** the name by which the attribute is known to the local Access Manager server.
- **Request From Partner:** Indicates if this attribute is sent in the Request made to the IdP (a value for this attribute is requested by the SP).

Table 38-9 provides sample IdP attribute mappings.

**Table 38-9 Sample IdP Attribute Mappings**

| Message Attribute | Access Manager Session Attribute | Request for Inclusion |
|-------------------|----------------------------------|-----------------------|
| mail              | email                            | true                  |

**Table 38-9 (Cont.) Sample IdP Attribute Mappings**

| Message Attribute | Access Manager Session Attribute | Request for Inclusion |
|-------------------|----------------------------------|-----------------------|
| givenname         |                                  | true                  |
| sn                | surname                          |                       |
| uid               | uid                              |                       |

In a protocol where a SP can specify which attributes are required in a response from the IdP, a Message Attribute name is sent in the request to the IdP. In cases when the SP receives an assertion or response from an IdP, the Attributes from the assertion are stored in the Access Manager session. If no Access Manager value is specified, the Message Attribute is stored.

When creating or modifying an IdP partner profile, the Attribute Mapping Profile is displayed with a drop-down list. The `idp-attribute-profile` is the default profile. Select the default or click the green plus sign to create a custom mapping profile.

See [Creating Remote Identity Provider Partners](#).

The Ignore Unmapped Attributes checkbox (in the configuration screen) indicates how to deal with Assertion Attributes not present (or that are present but have no value in the Access Manager Session Attribute column). If this checkbox is not checked, all Assertion Attributes that are not present in the table (or don't have a value mapped to Access Manager) will be stored in the Access Manager session with the same attribute name it had in the Assertion. If checked, any Assertion Attribute not present in the table (or with no value mapped to Access Manager) will be ignored and not added to the Access Manager session.

---



---

**Note:**

When the Identity Federation instance is configured as an SP it can request attributes only if the federation protocol used supports it. OpenID 2.0 supports this feature; SAML 2.0 and SAML 1.1 do not.

---



---

## 38.6 Mapping Federation Authentication Methods to Access Manager Authentication Schemes

A Federation Authentication Method (FAM) is an identifier representing an authentication mechanism in Federation messages.

This identifier can either be well known (such as the identifiers defined in the SAML specifications like `urn:oasis:names:tc:SAML:2.0:ac:classes:PasswordProtectedTransport` or `urn:oasis:names:tc:SAML:1.0:am:password`) or it can be an arbitrary identifier agreed upon between the two communicating partners.

In its responsibilities as an IdP, Identity Federation generates an Assertion (SAML or OpenID) that might contain information on how the user was authenticated. During the Assertion generation process, the IdP will retrieve the Authentication Scheme with which the user was authenticated and attempt to map it to a FAM. If such a mapping

exists, the IdP will include the FAM in the outgoing Assertion. If no mapping exists, the IdP will include the defined Authentication Scheme as the FAM in the Assertion.

---



---

**Note:**

Session attributes can be used in proxy mode when a mapping is not defined. Identity Federation (when acting as an IdP) can use session attributes for the FAM value when creating the assertion, if both protocols are equivalent.

---



---

[Table 38-10](#) lists the default, out-of-the-box mappings between FAMs and Access Manager Authentication Schemes.

**Table 38-10 Default Federation Authentication Method and Access Manager Authentication Scheme Mappings**

| Protocol                  | Mapping                                                                                                                                                                                                                                                                                                                 |
|---------------------------|-------------------------------------------------------------------------------------------------------------------------------------------------------------------------------------------------------------------------------------------------------------------------------------------------------------------------|
| saml20-sp-partner-profile | urn:oasis:names:tc:SAML:2.0:ac:classes:PasswordProtectedTransport to: <ul style="list-style-type: none"> <li>• LDAPScheme (scheme used if the SP Partner requests urn:oasis:names:tc:SAML:2.0:ac:classes:PasswordProtectedTransport)</li> <li>• FAAuthScheme</li> <li>• BasicScheme</li> <li>• BasicFAScheme</li> </ul> |
| saml11-sp-partner-profile | urn:oasis:names:tc:SAML:1.0:am:password to: <ul style="list-style-type: none"> <li>• LDAPScheme (scheme used if the SP Partner requests urn:oasis:names:tc:SAML:1.0:am:password)</li> <li>• FAAuthScheme</li> <li>• BasicScheme</li> <li>• BasicFAScheme</li> </ul>                                                     |

More details are included in the following topics:

- [Understanding Federation SSO As An IdP](#)
- [Understanding Federation SSO As An SP](#)
- [Configuring an Alternate Authentication Scheme](#)
- [Using WLST For Mapping Administration](#)

### 38.6.1 Understanding Federation SSO As An IdP

When Identity Federation acts as an IdP, it processes incoming Authentication Request messages sent by SP partners.

These messages might specify a FAM with which the user should be challenged by Access Manager (the IdP). If the Authentication Request contains a FAM, the IdP will attempt to map it to an Access Manager Authentication Scheme. If such a mapping is defined, Access Manager will authenticate the user using that scheme - only if the user needs to be challenged. The user would need to be challenged if, for example, the session timed out or does not exist or, the authentication level of the current session is

lower than the level of the mapped Authentication Scheme or, the user has not yet been authenticated by Access Manager. If no mapping is defined, the IdP will return an error to the SP indicating that the FAM is unknown.

When the IdP Authentication Module invokes Access Manager to challenge the user, it will determine the Authentication Scheme to be used for the operation in one of the following ways:

- The SP requests a specific means to authenticate the user with a Federation Authentication Request.
- The SP settings in the IdP configuration that define a default scheme. The Partner configuration is checked first, followed by the Partner Profile configuration and finally the global default Authentication Scheme defined in the IdP configuration (LDAPScheme).

---

---

**Note:**

By default, the Partner and Partner Profile configurations do not define a default Authentication Scheme. As such, the global default Authentication Scheme is in effect: LDAPScheme.

---

---

After authentication, the IdP creates an Assertion and maps the Access Manager Authentication Scheme (and appropriate level) to a FAM, if such a mapping exists. The FAM is set as the Authentication Context. If no mapping exists, Identity Federation sends the default Access Manager Authentication Scheme as the Authentication Context. Following this process, the user is redirected back to Identity Federation.

## 38.6.2 Understanding Federation SSO As An SP

When acting as an SP in a Federation SSO process, Identity Federation processes an incoming Assertion generated by an IdP partner.

This process results in the creation of an Access Manager session for the user and the mapping of the FAM contained in the Assertion to the default SchemeID/Access Manager authentication scheme. Identity Federation provides the authentication level, if set, that should be used when Access Manager creates the user session. (By default, the Authentication Level of the Access Manager session will be set to the Authentication Level of the defined FederationScheme.) The FAM will be saved as a session attribute.

The administrator can define a mapping where the SP will create an Access Manager session with a level set to the mapped Authentication Level for the FAM contained in the Assertion. This provides a way to reflect the strength of the mechanism with which the user was originally authenticated by the IdP.

## 38.6.3 Configuring an Alternate Authentication Scheme

An alternate Authentication Scheme is only configurable using WLST commands and not the Oracle Access Management Console.

During a Federation SSO operation, the IdP invokes the Access Manager Authentication Module to challenge the user when required; for example, if the user is not authenticated in Access Manager, has an Access Manager session that has been inactive too long or timed out or, if the Service Provider indicates (with a Federation

Authentication Request) that the IdP must re-challenge the user. For certain clients, an IdP might be required to use another Authentication Scheme to challenge a user besides the default one. This is especially true for mobile phones when an administrator might want to challenge a user with an Authentication Scheme that is different than the one used for computer-based browsers; for example, instead of an HTTP Basic Authentication Scheme, a scheme designed for mobile clients would be used.

Identity Federation (when working as an IdP) can be configured to evaluate whether an alternate Authentication Scheme should be used instead of the configured one by examining the HTTP Header sent by the user's browser. Identity Federation evaluates based on the following configurable settings:

- A setting indicating which HTTP Header attribute is sent by the user's browser.
- A setting containing a regular expression that will evaluate the value of the above HTTP Header attribute.
- A setting containing the alternate Authentication Scheme to use.

---

---

**Note:**

If the SP requested a specific Authentication Scheme, evaluation does not apply.

---

---

For information on the `setSPPartnerAlternateScheme` and `setSPPartnerProfileAlternateScheme` WLST commands that are used to configure alternate Authentication Scheme, see *WLST Command Reference for WebLogic Server*.

### 38.6.4 Using WLST For Mapping Administration

All Authentication Method/Scheme/Level mappings are configured using the WLST commands.

This can be done either at the partner level or, if not defined at the partner level, at the partner profile level.

See [Using WLST for Identity Federation Administration](#).

## 38.7 Using the Attribute Sharing Plug-in for the Attribute Query Service

Identity Federation provides an attribute sharing plug-in to enable Access Manager to request user attributes from an IdP.

In this interaction, the SP is an <AttributeQuery> requestor and the IdP is an <AttributeQuery> responder. The Attribute Sharing Plug-in depends on the Attribute Query Service, a request/response protocol transported using SOAP.

---

---

**Note:**

The Attribute Sharing Plug-in leverages the AttributeQuery requestor service to implement (a superset of) the X.509 Authentication Based Attribute Sharing Profile (XASP) in the context of Access Manager authentication flows.

---

---

Identity Federation (when configured as an SP) can send a SAML 2.0 <AttributeQuery> to the IdP in response to a SOAP call. The plug-in can be configured as a step in an Authentication Scheme. It can be invoked after authentication (by another plug-in) to fetch attributes for the authenticated user and set them into the Access Manager session. The following sections contain additional details.

- [Understanding the Plug-in and Query Service Design](#)
- [Configuring for Attribute Sharing](#)

### 38.7.1 Understanding the Plug-in and Query Service Design

Identity Federation must be configured as an SP to request user attributes from a remote IdP.

Figure 38-4 illustrates the design of the Attribute Sharing plug-in from a high level.

**Figure 38-4 Attribute Sharing Plug-in Design**

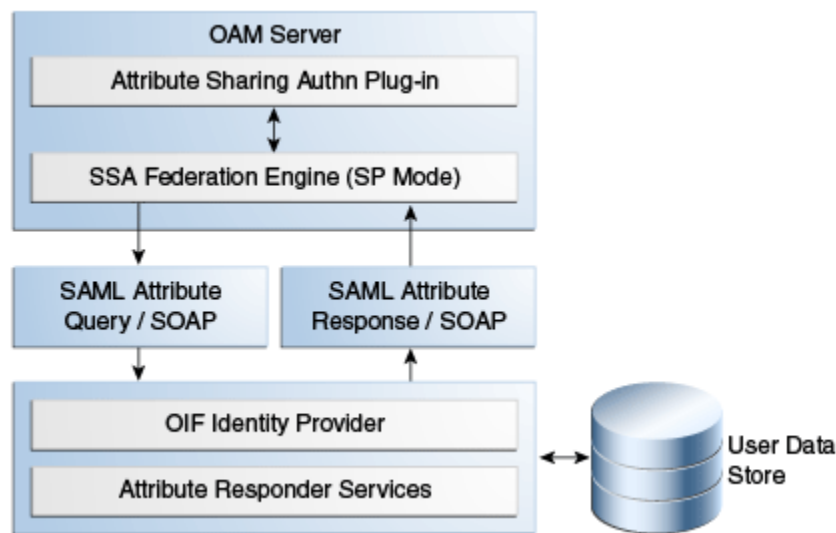

The Attribute Sharing plug-in can be part of an Access Manager Custom Authentication Module and is invoked after a user has been authenticated. The Attribute Sharing plug-in will fetch the user attributes by invoking the Identity Federation Java API, setting the attributes into the Access Manager session and transforming the Java arguments into an Attribute Request that can be processed by the SP. The Identity Federation SP receives the Attribute Request (at an exposed SOAP endpoint), determines the attributes being requested and sends an (optionally) signed and encrypted SAML 2.0 <AttributeQuery> using the requested attribute names over a SOAP/HTTP/SSL channel to the IdP's Attribute Responder Service.



---

**Note:**

When invoking the Attribute Sharing plug-in, the framework will provide the following for inclusion in the <AttributeQuery>:

- User ID of the authenticated user or SubjectDN if available
  - Partner ID user session attribute (available only if the Federation Authentication plug-in was used to authenticate user)
  - Tenant Name
  - IdP Name if the plug-in was created specifically for an IdP
- 

The Attribute Responder Service (at the remote IdP) receives the <AttributeQuery>, decrypts it (verifying the signature if necessary) and determines (from its local policy) if the SP is authorized to request the attributes. If so, it retrieves the attributes from a user repository, constructs and (optionally) signs and encrypts an <Assertion> (with an <AttributeStatement> containing the attribute values) and returns a <Response> with the assertion to the SP. On receiving the <Response>, the SP decrypts the assertion, verifies (if necessary) its signature, extracts the attributes from the assertion and set the information in the Access Manager session. The following sections contain more details.

- [Using the SP Attribute Requester](#)
- [Using the IdP Attribute Responder](#)
- [Using the SOAP Endpoint](#)

#### 38.7.1.1 Using the SP Attribute Requester

The Attribute Requester Service processes the SOAP Attribute Request and returns a SOAP Attribute Response.

See [Using the SOAP Endpoint](#).

The Attribute Request includes a SubjectDN and a list of other requested attributes and their values. The Attribute Requester Service identifies the IdP from which to fetch attributes by extracting one of the following (searched for in the order listed) from the request.

To use the SP Attribute Requester

1. The partner/IdP name if the request comes from the Federation engine.
2. The IdP configured in the plug-in used for authentication.
3. The request's Subject DN to determine which IdP will get the query from the configured SubjectDN-IdP map. Map the SubjectDN from most specific (cn=Joe User,ou=Finance,o=Company,c=US) to least specific (c=US).
4. The default IdP.

Following this discovery, the Attribute Requester Service retrieves the SOAP Attribute Responder Service endpoint URL from the IdP's metadata and creates a list of attributes to fetch by processing the attributes in the request through the Attribute Mapping profile.

**Note:**

Attribute Mapping profile specified for the target IdP will be used to change any incoming attribute names as well as add any attributes that are configured as send-with-sso (always requested) in the Attribute Mapping for this IdP.

A SAML Attribute Query is generated with the attribute list and sent to the IdP's SOAP endpoint. Once a response is received, the subject is verified and the each attribute is extracted from the Assertion, its value is found and both attribute and value are cached. Finally, an Attribute Response SOAP message is constructed and returned to the caller.

The following example represents a sample SOAP Attribute Request.

**Sample SOAP Attribute Request**

```
<SOAP-ENV:Envelope xmlns:SOAP-ENV="http://schemas.xmlsoap.org/soap/envelope/">
 <SOAP-ENV:Body>
 <attrreq:AttributeRequest TargetIDP="adc.example.com"
 xmlns:attrreq="http://www.example.com/fed/ar/10gR3">
 <attrreq:Subject
 Format="oracle:security:nameid:format:emailaddress">alice@example.com
 </attrreq:Subject>
 <attrreq:Attribute Name="cn">
 </attrreq:Attribute>
 </attrreq:AttributeRequest>
 </SOAP-ENV:Body>
</SOAP-ENV:Envelope>
```

The following example represents a sample SOAP attribute response.

**Sample SOAP Attribute Response**

```
<?xml version="1.0" encoding="UTF-8" standalone="yes"?> <soap:Envelope
xmlns:wsa="http://schemas.xmlsoap.org/ws/2004/08/addressing" xmlns:ns2="http://
www.w3.org/2005/08/addressing" xmlns:wsp="http://schemas.xmlsoap.org/ws/2004/09/
policy" xmlns:enc="http://www.w3.org/2001/04/xmlenc#"
xmlns:md="urn:oasis:names:tc:SAML:2.0:metadata" xmlns:wst14="http://docs.oasis-
open.org/ws-sx/ws-trust/200802" xmlns:samlp="urn:oasis:names:tc:SAML:2.0:protocol"
xmlns:ic="http://schemas.xmlsoap.org/ws/2005/05/identity"
xmlns:mdext="urn:oasis:names:tc:SAML:metadata:extension" xmlns:wst="http://
schemas.xmlsoap.org/ws/2005/02/trust" xmlns:ns11="http://docs.oasis-open.org/ws-
sx/ws-trust/200512" xmlns:soap="http://schemas.xmlsoap.org/soap/envelope/"
xmlns:saml="urn:oasis:names:tc:SAML:1.0:assertion"
xmlns:ns14="urn:oasis:names:tc:SAML:2.0:assertion" xmlns:xrds="xri://$xrds"
xmlns:xrd="xri://$xrd*($v*2.0)" xmlns:tns="http://schemas.xmlsoap.org/ws/2005/07/
securitypolicy" xmlns:ns18="http://docs.oasis-open.org/ws-sx/ws-securitypolicy/
200702" xmlns:ns19="urn:oasis:names:tc:SAML:1.0:protocol" xmlns:ns20="http://
www.w3.org/2003/05/soap-envelope" xmlns:wssell="http://docs.oasis-open.org/wss/
oasis-wss-wssecurity-secext-1.1.xsd" xmlns:dsig="http://www.w3.org/2000/09/
xmldsig#" xmlns:query="urn:oasis:names:tc:SAML:metadata:ext:query"
xmlns:wsu="http://docs.oasis-open.org/wss/2004/01/
oasis-200401-wss-wssecurity-utility-1.0.xsd" xmlns:wsse="http://docs.oasis-
open.org/wss/2004/01/
oasis-200401-wss-wssecurity-secext-1.0.xsd" xmlns:xsi="http://www.w3.org/2001/
XMLSchema-instance" xmlns:x500="urn:oasis:names:tc:SAML:
2.0:profiles:attribute:X500" xmlns:orafed-arxs="http://www.oracle.com/fed/ar/
10gR3" xmlns:mdattr="urn:oasis:names:tc:SAML:metadata:attribute"
xmlns:ns31="urn:oasis:names:tc:SAML:profiles:vlmetadata"
xmlns:ecp="urn:oasis:names:tc:SAML:2.0:profiles:SSO:ecp">
```

```
<soap:Body><orafed-arxs:AttributeResponse CacheFor="899"> <orafed-
arxs:Status>Success</orafed-arxs:Status> <orafed-arxs:Subject
Format="oracle:security:nameid:format:emailaddress">
 alice@example.com</orafed-arxs:Subject> <orafed-arxs:Attribute Name="cn"> <orafed-
arxs:Value>alice</orafed-arxs:Value> </orafed-arxs:Attribute> </orafed-
arxs:AttributeResponse></soap:Body></soap:Envelope>
```

### 38.7.1.2 Using the IdP Attribute Responder

The Identity Federation IdP Attribute Responder receives the SAML Attribute Query and returns a SAML response with an Attribute Statement that contains values for the requested attributes. The IdP first identifies the requester as an SP partner and then confirms that the user is in the user data store by searching on the NameID or SubjectDN value. It then uses the Attribute Mapping profile of the SP partner to retrieve values for each of the requested attributes. Finally, it constructs and returns a SAML response containing an Attribute Statement with attribute values.

---



---

#### Note:

The Attribute Responder uses the SP partner's Attribute Mapping profile to retrieve values. An empty value is returned for an attribute if there is no mapping present in the Attribute Mapping profile. If the value expression contains variables in the namespace of a session or request, this also evaluates to an empty string. Value Expressions in the Attribute Mapping Profile can only use variables in the namespace of `user.attr` to be evaluated correctly.

---



---

### 38.7.1.3 Using the SOAP Endpoint

The Attribute Requester Service on the SP exposes a SOAP interface for client requests. The SOAP service is available on the SP at the following URL:

```
http://<SP-managed-server>:<SP-port>/oamfed/ar/soap
```

## 38.7.2 Configuring for Attribute Sharing

Attribute Sharing Plug-in can optionally be provided with the configuration parameters.

[Table 38-11](#) lists the Attribute Sharing Plug-in.

**Table 38-11 Configuration Parameters for Attribute Sharing Plug-in**

| Parameter                   | Description                                                                                                       |
|-----------------------------|-------------------------------------------------------------------------------------------------------------------|
| NameIDValueAttribute        | The name of the session attribute from which the user's nameID can be retrieved.                                  |
| NameIDFormatAttribute       | The name of the attribute that contains the value to be used as the nameID format.                                |
| AttributeAuthorityAttribute | The name of the attribute that contains the value used as the IdP to which the SP will send the <AttributeQuery>. |

**Table 38-11 (Cont.) Configuration Parameters for Attribute Sharing Plug-in**

| Parameter                 | Description                                                                                                                                                                                                                                                                                                                              |
|---------------------------|------------------------------------------------------------------------------------------------------------------------------------------------------------------------------------------------------------------------------------------------------------------------------------------------------------------------------------------|
| RequestedAttributes       | This parameter can be used to specify attributes to be requested in the URL query format; for example, <code>attr1&amp;attr2&amp;attr3=value1</code> . In this case, <code>attr1</code> and <code>attr2</code> will be fetched but <code>attr3</code> will be present in the response ONLY if one of its values is <code>value1</code> . |
| DefaultNameIDFormat       | The nameID format to be used if it is undetermined from the other parameters and session attributes.                                                                                                                                                                                                                                     |
| DefaultAttributeAuthority | The default IdP partner from whom to request the user's attributes.                                                                                                                                                                                                                                                                      |

The Attribute Sharing Plug-in can also access the attributes documented in [Table 38-12](#). These attributes may be present in the Access Manager session during its operation.

**Table 38-12 Session Attributes Accessible To Attribute Sharing Plug-in**

| Attribute        | Description                                                                                                                                                                                                                   |
|------------------|-------------------------------------------------------------------------------------------------------------------------------------------------------------------------------------------------------------------------------|
| fed.partner      | If Federation was used to authenticate the user, this value is used to determine the IdP used. The same IdP would then be used for Attribute Sharing.                                                                         |
| fed.nameidformat | If Federation was used to authenticate the user, the value of this attribute is used to determine the NameID format.                                                                                                          |
| fed.nameidvalue  | If Federation was used to authenticate the user, the value of this attribute is used to determine the NameID of the user. If present in the session, it will be used as the DN to locate the user in the SP's identity store. |
| KEY_USERNAME_DN  | If this value is present, it will be used as the DN to locate the user in the SP's identity store.                                                                                                                            |

The following sections have additional details on parameters and how they determine how the Attribute Sharing process.

- [NameID](#)
- [NameID Format](#)
- [IdP](#)
- [RequestedAttributes](#)

### 38.7.2.1 NameID

This is the name identifier of the user for whom the SP is requesting attributes.

To determine the NameID, the following searches will be conducted in order.

In the Attribute Sharing plug-in

1. If the `NameIDValueAttribute` is specified, retrieve the value of the specified attribute from the session and use it as the `NameID`.
2. If `NameIDValueAttribute` is not specified, use the value of `fed.nameidvalue` for the `NameID`.
3. If undetermined by the above, the Attribute Sharing Plug-in will invoke the Federation Engine with a null/empty `NameID` and the `UserID` (specified in the `KEY_USERNAME_DN` session attribute) is sent to the SP Attribute Requester.

In the Attribute Requester (SP)

1. If the `NameID` is in the Request, use its value for the user's `nameID`.
2. If a `NameID` is undetermined but a `UserID` is present (which occurs when invoking the Authentication Plug-in), retrieve the value of the `defaultattrrequestnameiduserattribute` attribute (found in the SP configuration for this IdP) and use it as the `NameID`.
3. When using SAML 2.0 only: If a `NameID` is not determined and SSO is configured for Simple `NameID` mapping, use the `nameiduserattribute` attribute (found in the SP configuration for this IdP). For example, if the value of this attribute is `$user.attr.mail`, extract the name of the user from this attribute and use it as the `NameID`.
4. If a `NameID` is still undetermined, an error is thrown.

### 38.7.2.2 NameID Format

This is the format of the user's `NameID`.

To determine the `NameID` format, the following searches will be conducted in order. In the Attribute Sharing plug-in

1. If the `NameIDFormatAttribute` parameter is specified, retrieve the value of the specified attribute and use it as the `NameID` format.  
See [Table 38-11](#).
2. Use the value of the `fed.nameidformat` attribute as the `NameID` format.  
See [Table 38-12](#).
3. Use the value of the `DefaultNameIDFormat` as the `NameID` format.  
See [Table 38-11](#).
4. If `NameID` Format is still undetermined, the Attribute Sharing plug-in will invoke Federation with a null/empty `NameID` Format.

In the Attribute Requester (SP)

1. Use the `NameID` Format specified in the request.
2. Use the value of the `defaultattrrequestnameidformat` attribute (found in the SP configuration for this IdP).
3. When using SAML 2.0 only: If the `NameID` Format is still undetermined, use the value of the `defaultauthnrequestnameidformat` attribute (found in the SP configuration for this IdP).
4. If a `NameID` Format is still undetermined, an error is thrown.

### 38.7.2.3 IdP

This is the IdP partner to which the attribute request should be sent.

To determine the IdP partner, the following searches will be conducted in order. In the Attribute Sharing plug-in

1. If the `AttributeAuthorityAttribute` as specified, retrieve its value and use it as the IdP name.  
See [Table 38-11](#).
2. Use the value of the `fed.partner` attribute as the IdP name.  
See [Table 38-12](#).
3. Use the value of the `DefaultAttributeAuthority` parameter as the IdP name.  
See [Table 38-11](#).
4. If the IdP is still undetermined, the Attribute Sharing plug-in will invoke Federation with a null/empty `NameID Format`.

In the Attribute Requester (SP)

1. Use the IdP name included with the request sent to the Attribute Sharing plugin.
2. When using x509 only: look up the `dn-idp` mapping to determine the IdP for this user DN.
3. Use the value of the `defaultattrauthority` attribute (found in the SP configuration).
4. Use the value of the `defaultssoidp` attribute (found in the SP configuration).
5. If an IdP name is still undetermined, an error is thrown.

### 38.7.2.4 RequestedAttributes

These are the attributes to be requested from the Attribute Authority.

To determine the attributes, the following searches will be conducted in order. In the Attribute Sharing plug-in

If the `RequestedAttributes` parameter is defined, use the attributes specified. If none are specified, no attributes are sent.

See [Table 38-11](#).

In the Attribute Requester (SP)

1. If the `RequestedAttributes` parameter is defined, use the attributes specified.  
See [Table 38-11](#).
2. Append (or add) attributes to the `request from partner(send-with-sso)` attribute in the IdP partner profile.

In the Attribute Responder (IdP)

1. If the `<AttributeQuery>` from the SP contains requests for specific attribute values, return values for those attributes.

2. If no attribute values are requested, return any attributes specified as `Always Send` (`send-with-sso`) in the SP attribute profile configuration.

## 38.8 Using the Federation Proxy

When configured as an IdP, Identity Federation can enable the Federation Proxy to receive an Authentication Request from a remote SP partner.

Rather than authenticating the user locally, the IdP begins a second Federation SSO flow (SP2) with a second, remote IdP (IdP2). IdP2 then authenticates the user, creates an Assertion and redirects the user back to the Federation Proxy (IdP/SP2). The proxy validates the Assertion, identifies the user and resumes the first Federation SSO flow by creating a second Assertion and redirecting the user back to the original SP. With Federation Proxy, the first IdP is proxying the authentication to the second IdP.

---

---

**Note:**

The Federation Proxy does not refer to the HTTP Proxy settings listed under Federation Settings. That is used by Identity Federation to connect to remote servers when a firewall is present.

---

---

To use Federation IdP Proxy, the administrator configures Identity Federation to use `FederationScheme` for authentication rather than a local scheme (like `LDAPScheme` or `BasicScheme`). At runtime, if the user needs to be authenticated using the `FederationScheme`, Identity Federation will act as an SP and start the Federation SSO flow with a remote IdP.

---

---

**Note:**

There is an option to include the proxied Federation authentication method used by the second IdP in the Assertion created for the first SP. This is only possible if the Federation SSO operation between SP2 and IdP2 use the same protocol as the one used between SP1 and IdP1.

---

---

## 38.9 Using WLST for Identity Federation Administration

Identity Federation uses WLST commands for administration.

There are commands for managing authentication mappings, partner profiles, and SAML 1.1 that do not have applicable administrative fields for configuration in the Oracle Access Management Console. For information on these and other WLST commands, familiarize yourself with the following document:

See the *Oracle Fusion Middleware WebLogic Scripting Tool Command Reference for Identity and Access Management*.





---

# Managing Settings for Identity Federation

Introduction to the settings that you must configure for use by Oracle Access Management Identity Federation.

This chapter includes the following sections:

- [Prerequisites for Settings in Federation Identity](#)
- [About Federation Settings](#)
- [Managing General Federation Settings](#)
- [Managing Proxy Settings for Federation](#)
- [Defining Keystore Settings for Federation](#)
- [Exporting Metadata](#)

## 39.1 Prerequisites for Settings in Federation Identity

The following topics presume that you have performed tasks in [Managing Identity Federation Partners](#).

## 39.2 About Federation Settings

This topic introduces the federation settings that must be configured to enable the Identity Federation functionality available from the Oracle Access Management Console.

[Figure 39-1](#) shows the Federations Settings page as it appears in the Oracle Access Management Console. This page is the same whether you choose Identity Federation Service Settings from the Welcome page, Configuration panel, or you display the Federation section of the System Configuration tab and choose Federation Settings.

**Figure 39-1 Identity Federation Service Settings Page**

**Federation Settings**  
The following settings must be configured to enable the Identity Federation functionality available from the Oracle Access Management Console.

**General**

\* Provider Id  Encryption Key

Succinct Id  Custom Trust Anchor File

Signing Key

**Proxy**

Enable Proxy

Host  Username

Port  Password

Non-Proxy Hosts

**Keystore**

Keystore Location /scratch/prate/mwhome/user\_projects/domains/base\_domain/config/fmwconfig/oaamkeystore

| Row | Key ID          | Alias              | password | Description          |
|-----|-----------------|--------------------|----------|----------------------|
| 1   | osts_encryption | stsprivatekeyalias | *****    | <input type="text"/> |
| 2   | osts_signing    | stsprivatekeyalias | *****    | <input type="text"/> |

Table 39-1 outlines the types of federation settings you can configure.

**Table 39-1 Federation Settings in the Console**

| Elements | Description                                                                                                                                                                      |
|----------|----------------------------------------------------------------------------------------------------------------------------------------------------------------------------------|
| General  | General federation settings include basic information about the provider and the keys used to send assertions.<br>See Also: <a href="#">Managing General Federation Settings</a> |
| Proxy    | Proxy settings enable you to set up a proxy server for federation.<br>See Also: <a href="#">Managing Proxy Settings for Federation</a>                                           |
| Keystore | Keystore settings enable you to create aliases (a short hand notation) for keys in the keystore.<br>See Also: <a href="#">Defining Keystore Settings for Federation</a>          |

## 39.3 Managing General Federation Settings

The following topics describe how to manage general Federation Settings:

- [About Managing General Federation Settings](#)
- [Managing General Federation Settings](#)

### 39.3.1 About Managing General Federation Settings

You view and manage general federation properties on the Federation Settings page of the console.

Figure 39-1 shows the General section of the Federation Settings page.

Table 39-2 describes each element on the General section of the Federation Settings page.

**Table 39-2 General Federation Settings**

| Element                  | Description                                                                                                                                                                                                                                                                                                                                                                                                                                                                   |
|--------------------------|-------------------------------------------------------------------------------------------------------------------------------------------------------------------------------------------------------------------------------------------------------------------------------------------------------------------------------------------------------------------------------------------------------------------------------------------------------------------------------|
| Provider ID              | This is the provider ID of this federation server. For example, <code>http://foo.example.com/fed</code> .                                                                                                                                                                                                                                                                                                                                                                     |
| Signing Key              | This key is used to sign assertions.                                                                                                                                                                                                                                                                                                                                                                                                                                          |
| Encryption Key           | This key is used to decrypt incoming messages.                                                                                                                                                                                                                                                                                                                                                                                                                                |
| Custom Trust Anchor File | Specifies a keystore that contains trusted root certificates use in federation. The default trust store is <code>\$DOMAIN_HOME/config/fmwconfig/amtruststore</code> .<br>In most cases, the default trust anchor should be enough. If necessary, specify the location of an alternate keystore to use.<br><i>Note:</i> When you use a custom trust anchor keystore, it will not be replicated automatically across the cluster. You must manage replication of this keystore. |
| Export SAML 2.0 Metadata | After changes to the General settings, you must export the metadata for use by federation partners.<br>See Also: <a href="#">Exporting Metadata</a>                                                                                                                                                                                                                                                                                                                           |

## 39.3.2 Managing General Federation Settings

General settings include basic information about a provider.

### 39.3.2.1 Prerequisites for General Federation Settings

None.

### 39.3.2.2 Setting or Modifying General Settings for Federation

You can set or modify General settings for Federation.

To set or modify:

1. In the Oracle Access Management Console, click **Federation** at the top of the window.
2. In the Federation console, Select **Federation** from the drop-down list in the **Settings** section.
3. On the Federation Settings page, enter General Settings values for your ([Table 39-2](#)).
4. Click **Apply** to save your changes.
5. Proceed to "[Managing Proxy Settings for Federation](#)".

## 39.4 Managing Proxy Settings for Federation

This topic is organized in the following sections.

- [About Proxy Settings for Federation](#)
- [Managing Proxy Settings for Identity Federation](#)

### 39.4.1 About Proxy Settings for Federation

A proxy may be required when Identity Federation needs to directly connect to the federation partner, such as in a SAML artifact SSO operation. You view and manage a proxy configured for use with federation partners on the Federation Settings page of the console.

[Figure 39-1](#) illustrates the Federation Proxy Settings section of the Federation Settings page. [Table 39-3](#) describes each element on the Federation Proxy Settings section of the Federation Settings page.

**Table 39-3 Federation Proxy Settings**

| Element         | Description                                                                                                                                           |
|-----------------|-------------------------------------------------------------------------------------------------------------------------------------------------------|
| Enable Proxy    | Checking the box enables the proxy server. When the box is unchecked, the Proxy function is disabled and related fields are inaccessible for editing. |
| Host            | This element specifies the proxy hostname.                                                                                                            |
| Port            | This element specifies the proxy port number.                                                                                                         |
| Non-proxy Hosts | This is a list of hosts for which the proxy should not be used. Use ';' to separate multiple hosts.                                                   |
| Username        | This is the proxy user name to use when connecting to the proxy.                                                                                      |
| Password        | This is the proxy password to use when connecting to the proxy.                                                                                       |

### 39.4.2 Managing Proxy Settings for Identity Federation

Skip Step 1 if you are viewing the Federation Settings page.

#### 39.4.2.1 Prerequisites for Proxy Settings for Identity Federation

None.

#### 39.4.2.2 Setting or Modifying Proxy Settings for Federation

You can set or modify Proxy settings for Federation.

To set or modify:

1. In the Oracle Access Management Console, click **Federation** at the top of the window.
2. In the Federation console, Select **Federation** from the drop-down list in the **Settings** section.
3. On the Federation Settings page, evaluate current proxy settings values against those needed for your environment.
4. Fill in the Proxy settings using values for your environment ([Table 39-3](#)).
5. Click **Apply** to save your changes.

- Proceed to "[Defining Keystore Settings for Federation](#)".

## 39.5 Defining Keystore Settings for Federation

The following topics describe how to define Keystore settings for Federation:

- [About Managing Keystore Settings for Identity Federation](#)
- [Managing Identity Federation Encryption/Signing Keys](#)

### 39.5.1 About Managing Keystore Settings for Identity Federation

You view and manage keystores configured for use with federation partners on the Federation Settings page of the console.

[Figure 39-2](#) illustrates the expanded Federation Proxy Settings section of the Federation Settings page.

**Figure 39-2 Keystore Settings**

Keystore Location /scratch/prate/mwhome/user\_projects/domains/base\_domain/config/fmwconfig/oamkeystore

| Row | Key ID          | Alias              | password | Description |
|-----|-----------------|--------------------|----------|-------------|
| 1   | osts_encryption | stsprivatekeyalias | .....    |             |
| 2   | osts_signing    | stsprivatekeyalias | .....    |             |

Dropdown menu for Alias (Row 2):

- adminserver
- coherence
- assertion-key
- oam.server.cert
- stscertalias
- stsprivatekeyalias**
- oam.ca
- pat
- oam.simple.cert
- oam\_server1
- assertion-cert
- oam.simple.cert.keyalias

[Table 39-4](#) describes each element on the Keystore Settings section of the Federation Settings page.

**Table 39-4 Keystore Settings for Federation**

| Element           | Description                                                                                                                                    |
|-------------------|------------------------------------------------------------------------------------------------------------------------------------------------|
| Keystore Location | This element specifies the keystore path.                                                                                                      |
| Key ID            | This is the unique key ID.                                                                                                                     |
| Description       | This element provides a brief description of the key, such as its usage type.                                                                  |
| Alias             | This element specifies the key alias.<br><i>Note:</i> You can choose one of the aliases that is available in the keystore using the drop-down. |
| Password          | This element specifies the key password.                                                                                                       |

### 39.5.2 Managing Identity Federation Encryption/Signing Keys

As described in [Managing Data Sources](#), Identity Federation uses keys in the following keystore to store encryption and signing certificates:

\$DOMAIN\_HOME/config/fmwconfig/.oamkeystore

### 39.5.2.1 Task Overview: Managing Identity Federation Encryption/Signing Keys

- [Resetting the System \(.oamkeystore\) and Trust \(amtruststore\) Keystore Password](#)
- [Adding a New Key Entry to the System Keystore \(.oamkeystore\)](#)

---

---

**Note:**

AM denotes Access Manager, STS denotes Security Token Service, and IF denotes Identity Federation in this discussion.

---

---

### 39.5.2.2 Resetting the System (.oamkeystore) and Trust (amtruststore) Keystore Password

You can reset the password that protects the keystores as well as the key entries which use the same password as the keystore.

The keystores have been created and configured by the IM/OAMAM/OSTS installer, and the password and the key entries password were randomly generated. The WLST `resetKeystorePassword` method allows you to set the `.oamkeystore` password and any key entries with a password identical to the `.oamkeystore` password to a new value. The command updates the:

- `.oamkeystore` password
- Key entries in the `.oamkeystore` which had the same password as the keystore
- OAMAM/STS/IF configuration to reflect the change
- `amtruststore` password if the keystore is protected by the same password as the `.oamkeystore` (default)

To set the system keystore (`.oamkeystore`) password:

1. Enter the WLST scripting environment.
2. Connect to the WebLogic Server AdminServer, using the `connect ( )` command.
3. Navigate to the domain runtime tree: `domainRuntime ( )`.
4. Execute the following command:

```
resetKeystorePassword()
```

5. Enter and confirm the password.

### 39.5.2.3 Adding a New Key Entry to the System Keystore (.oamkeystore)

You can add a new key entry into the system keystore (`.oamkeystore`) using the `keytool` command to create and add the new key entry.

Once the entry has been added, it must be defined in the Identity Federation settings configuration screen so that it can be used to sign assertions and decrypt incoming messages.

### 39.5.2.3.1 Task Overview: Adding a New Key Entry to the System Keystore (.oamkeystore)

The following topics describe how to add a new entry to the system keystore to sign SAML assertions or decrypt XML-encrypted data not covered by WSS:

- [Adding a New Entry in the .oamkeystore](#)
- [Adding a New Entry in the Identity Federation Settings](#)
- [Configuring the Signing and Encryption Key](#)

### 39.5.2.3.2 Adding a New Entry in the .oamkeystore

There are no prerequisites for this task. The system keystore (.oamkeystore) password has been reset.

To add a new entry in the .oamkeystore:

1. Locate keytool.
2. Use keytool to:
  - Generate a self-signed certificate, or
  - Generate a certificate request, export the request to a remote Certificate Authority (CA), and finally import the certificate issued by the CA.

### 39.5.2.3.3 Adding a New Entry in the Identity Federation Settings

In the Identity Federation settings, you can add a new row to the Keystore table.

To add a new entry in the Identity Federation settings:

1. In the Oracle Access Management Console, click **Federation** at the top of the window.
2. In the Federation console, Select **Federation** from the drop-down list in the **Settings** section.
3. On the Federation Settings page, navigate to the Keystore table.
4. Add a row.
5. Enter a key ID that will be used to reference this key when configuring Identity Federation.
6. Select the alias of the key entry stored in .oamkeystore.
7. Enter the key password.
8. Click **Apply**.

### 39.5.2.3.4 Configuring the Signing and Encryption Key

Once the key has been added to the keystore table, you can configure Identity Federation to use the key.

To configure the signing and encryption key:

1. In the Oracle Access Management Console, click **Federation** at the top of the window.

2. In the Federation console, Select **Federation** from the drop-down list in the **Settings** section.
3. Navigate to the General section.
4. Select the Signing Key from the list of available key entries that were defined in the keystore table.
5. Select the encryption key from the list of available key entries that were defined in the keystore table.
6. Click **Apply**.

Identity Federation will now use those keys to sign and decrypt messages.

#### 39.5.2.3.5 Using WLST for Key Transport Algorithm

Oracle Identity Federation supports RSA 1.5 as the key transport algorithm by default. The key transport algorithm can be changed from RSA 1.5 to RSA-OAEP based on the requirement, by adding a new property, defaultkeytransportmethod to **oam-config.xml** using the WLST commands.

You can configure the defaultkeytransportmethod parameter in **oam-config.xml** as follows:

```
<Setting Name="defaultkeytransportmethod" Type="xsd: xsd">
http://www.w3.org/2001/04/xmlenc#rsa-oaep-mgf1p
</Setting>
```

For example:

- To update the key transport algorithm for a specific partner only (in this example, OIFSP), use the following WLST command:

```
updatePartnerProperty(partnerName="OIFSP", partnerType="SP",
propName="defaultkeytransportmethod", propValue="http://www.w3.org/2001/04/
xmlenc#rsa-oaep-mgf1p", type="string")
```

- To update the key transport algorithm for all partners that use a specific partner profile (in this example, saml20-sp-partner-profile), use the following WLST command:

```
putStringProperty("/fedpartnerprofiles/saml20-sp-partner-profile/
defaultkeytransportmethod", "http://www.w3.org/2001/04/xmlenc#rsa-oaep-mgf1p");
```

- To update the key transport algorithm for all defined SP partners, use the following WLST command:

```
putStringProperty("/idpglobal/defaultkeytransportmethod", "http://www.w3.org/
2001/04/xmlenc#rsa-oaep-mgf1p")
```

---



---

**Note:** This is a global change.

---



---

## 39.6 Exporting Metadata

After you have made changes to the general settings, you can export the metadata for use by federation partners.

To export SAML 2.0 metadata:



1. In the Oracle Access Management Console, click **Federation** at the top of the window.
2. In the Federation console, Select **Federation** from the drop-down list in the **Settings** section.
3. On the Federation Settings page, click **Export SAML 2.0 Metadata**.
4. A dialog box appears where you must specify the file for the exported metadata.
5. Click **Save** to save your new metadata file.



---

## Managing Federation Schemes and Policies

If you want to enable Oracle Access Management Access Manager to work with federation providers, you define one or more authentication schemes. The defined schemes authenticate users that request access to resources protected by Access Manager.

The following topics introduce authentication schemes and policies that you can configure for Oracle Access Management Identity Federation:

- [Use of Identity Federation and Access Manager Together](#)
- [Using Authentication Schemes and Modules for Identity Federation 11g Release 2 \(11.1.2.2\)](#)
- [Using Authentication Schemes and Modules for Oracle Identity Federation 11g Release 1](#)
- [Managing Access Manager Policies for Use with Identity Federation](#)
- [Testing Identity Federation Configuration](#)
- [Using the Default Identity Provisioning Plug-in](#)
- [Configuring the Identity Provider Discovery Service](#)
- [Configuring the Federation User Self-Registration Module](#)
- [Integrating OAM Identity Provider With Microsoft Office 365 Service Provider](#)

### 40.1 Use of Identity Federation and Access Manager Together

The use of federation features in Access Manager varies depending on the release.

When you integrate with Identity Federation:

- 11g Release 1 (11.1.1) sites, and those upgrading from 11g Release 1 (11.1.1) to 11g Release 2 (11.1.2), can use the integration.  
See .
- Sites with new 11g Release 2 (11.1.2) installations can leverage federation features using the Oracle Access Management Console.

See Chapter 3, *Deploying Oracle Identity Federation*, of for Identity Federation concepts, background, and high-level flows.

## 40.2 Using Authentication Schemes and Modules for Identity Federation 11g Release 2 (11.1.2.2)

The following topics describe how to use authentication schemes and modules for Identity Federation 11G Release 2 (11.1.2.2):

- [About the FederationScheme Authentication Scheme](#)
- [About the FederationMTScheme](#)
- [About the FederationPlugin Authentication Module](#)
- [Managing Authentication with Identity Federation in 11g Release 2](#)

### 40.2.1 About the FederationScheme Authentication Scheme

FederationScheme is a general-purpose scheme for use with Identity Federation 11g Release 2 (11.1.2.2).

Figure 40-1 shows the Access Console page for FederationScheme:

**Figure 40-1 FederationScheme**

**FederationScheme** Authentication Scheme  
An Authentication Scheme defines the challenge mechanism required to authenticate a user.

The screenshot displays the configuration page for the FederationScheme authentication scheme. The fields are as follows:

- Name:** FederationScheme
- Description:** FederationScheme
- Authentication Level:** 2 (with up and down arrow controls)
- Default:**
- Challenge Method:** FORM (with a dropdown arrow)
- Challenge Redirect URL:** /oam/server/
- Authentication Module:** FederationPlugin (with a dropdown arrow)
- Challenge URL:** /pages/servererror.jsp
- Context Type:** customWar (with a dropdown arrow)
- Context Value:** /oam
- Challenge Parameters:** initial\_command=NONE, is\_rsa=true

[Table 40-1](#) describes the `FederationScheme`.

**Table 40-1 FederationScheme Element Definitions**

Element	Description
Name	This is the scheme name.
Description	This is a brief description of the scheme.
Authentication Level	This is the trust level of the authentication scheme.
Default	This is a non-editable box that is checked when the <b>Set as Default</b> button is clicked.
Challenge Method	You may select a challenge method from those available in the drop-down box.
Challenge Redirect URL	This is the URL of another server to which user requests must be redirected for processing.
Authentication Module	This is the authentication module to use with the scheme.
Challenge URL	This is the URL to which the credential collector will redirect for credential collection. Not used by the federation plug-in.
Context Type	This element is used to build the final URL for the credential collector.
Context Value	This element is used to build the final URL for the credential collector. The value depends on the context type.
Challenge Parameters	This is the list of parameters, if any, to use with the challenge.

[Table 22-21](#) lists the specifications for `FederationScheme`.

## 40.2.2 About the FederationMTScheme

The `FederationMTScheme` authentication scheme is a scheme that is designed for use in multi-tenancy environments.

## 40.2.3 About the FederationPlugin Authentication Module

The `FederationPlugin` provides a custom authentication module.

[Figure 40-2](#) displays the module's Console page.

**Figure 40-2 FederationPlugin Steps**

**Authentication Module** Authentication Module Duplicate Apply

Custom Authentication Module relies on bundled plug-ins (or those that are developed using the Access Manager Authentication Extensibility Java API). This module uses more than one plug-in that you can orchestrate to ensure that each one performs a specific authentication function.

General **Steps** Steps Orchestration

View + × Detach

Step Name	Description	Plug-in Name
FedAuthnRequestPlugin	Federation Authn Reque...	FedAuthnRequestPlugin
AssertionProcessing	Assertion Processing	FedUserAuthenticationPlugin

Save Cancel

**Step Details**

Step Name FedAuthnRequestPlugin

Description Federation Authn Request to IdP

Plug-in Name FedAuthnRequestPlugin

FedForceAuthn

FedSSOIDP

FedPassive

Table 40-2 describes the attributes that you need to configure the FederationPlugin.

**Table 40-2 FederationPlugin Steps**

Element	Description
Step Name	This is the name of the step within the module.
Description	This element contains a brief description of the step.
Plugin Name	This element specifies the plugin associated with the step.

The value of FedSSOIDP is the IDP to be picked up by the authentication plugin.

Orchestration enables you to specify the order of the steps within the plugin, and what to do if each of those steps succeeds or fails.

Figure 40-3 illustrates the orchestration of the FederationPlugin.

See Table 22-14 for a similar orchestration.

**Figure 40-3 FederationPlugin Orchestration**

**Authentication Module** Authentication Module Duplicate Apply

Custom Authentication Module relies on bundled plug-ins (or those that are developed using the Access Manager Authentication Extensibility Java API). This module uses more than one plug-in that you can orchestrate to ensure that each one performs a specific authentication function.

General Steps **Steps Orchestration**

You can specify the initial step

\* Initial Step FedAuthnRequestPlugin

Name	Description	On Success	On Failure	On Error
FedAuthnRequestPlugin		success	AssertionProcessing	failure
AssertionProcessing		success	failure	failure

Table 40-3 describes the attributes for the orchestration of the FederationPlugin.

**Table 40-3** *Orchestration of FederationPlugin*

Element	Description
Name	This is the step name. The steps appear in this column in order of execution, which can be modified with the Initial Step drop-down.
Description	This is a brief description of the step.
On Success	This is the action to take upon successful completion of the step, such as execution of next step in the orchestration.
On Error	This is the action to take upon error, such as taking the specified failure action.
On Failure	This is the action to take upon step failure.

## 40.2.4 Managing Authentication with Identity Federation in 11g Release 2

When you manage authentication with Identity Federation in 11g Release 2, you work with the `FederationScheme` and the `FederationPlugin` plug-in, a custom authentication module.

The following topics introduce authentication with Identity Federation in 11g Release 2:

- [Prerequisites for the Authentication with Identity Federation in 11g Release 2](#)
- [Viewing or Modifying FederationScheme](#)
- [Viewing or Modifying FederationPlugin](#)
- [Adding an Authentication Policy with FederationScheme](#)

### 40.2.4.1 Prerequisites for the Authentication with Identity Federation in 11g Release 2

None.

### 40.2.4.2 Viewing or Modifying FederationScheme

You can view or modify `FederationScheme` authentication scheme.

To view or modify `FederationScheme`:

1. In the Oracle Access Management Console, click **Application Security** at the top of the window.
2. In the Application Security console, click **Authentication Schemes** in the **Access Manager** section.
3. Search for and open the `FederationScheme` authentication scheme.
4. Review `FederationScheme` details to ensure these are desired for your deployment.

[Table 40-1](#) describes field details.

5. Click **Save**.

#### 40.2.4.3 Viewing or Modifying FederationPlugin

You can view or modify `FederationPlugin` authentication plug-in.

To view or modify `FederationPlugin`:

1. In the Oracle Access Management Console, click **Application Security** at the top of the window.
2. In the Application Security console, click **Authentication Plug-ins** in the **Plug-ins** section.
3. Search for and open the `FederationPlugin` authentication plug-in.
4. Review `FederationPlugin` details to ensure these are desired for your deployment.

[Table 40-2](#) provides plugin step details.

5. Use the icons above the step table to add a step (+) or delete a step (x).
6. Modify the order of steps as needed using the Steps Orchestration tab.

[Table 40-3](#) provides orchestration details.

7. Click **Save**.

#### 40.2.4.4 Adding an Authentication Policy with FederationScheme

A *Prerequisite* represents any resource to be added to a policy that you must define in the same Application Domain as the policy. You can add an authentication policy with `FederationScheme` to associate a resource that is protected by this policy.

To add an authentication policy with `FederationScheme` to associate a resource that is protected by this policy:

1. In the Oracle Access Management Console, click **Application Security** at the top of the window.
2. In the Application Security console, click **Application Domains** in the **Access Manager** section.
3. Search for and open the target application domain.
4. In the application domain configuration page, click the **Authentication Policies** tab.
5. Click **Create** and enter the following General Policy Details.

[Table 25-9](#).

- Name
  - Authentication Scheme
6. Add these Global Policy Elements and Specifications:
    - Description (optional)
    - Success URL



- Failure URL
7. To add resources:
    - a. Click the Resources tab on the Authentication Policy page.
    - b. Click the **Add** button on the tab.
    - c. Choose a URL from the list.
    - d. Repeat these steps as needed to add more resources.
  8. Click **Apply** to save changes and close the confirmation window.
  9. **Responses:**

See [Introduction to Policy Responses for SSO](#).

See [Adding and Managing Policy Responses for SSO](#).

Figure 40-4 shows the console page to define the authentication policy and associate the policy to the resources.

**Figure 40-4 Setting Up the Authentication Policy with FederationScheme**

**Create Authentication Policy** Authentication Policy Apply

Authentication Policy defines the type of verification that must be performed to provide a sufficient level of trust for Access Manager to grant access to the user making the request. A single policy can be defined to protect one or more resources in the Application Domain.

\* Name: TestPolicy1

Description:

\* Authentication Scheme: FederationScheme

Success URL:

Failure URL:

Resources Responses Advanced Rules

Resources + Add ✕ Delete

Resource Type	Host Identifier	Resource URL	Query String
This Policy does not protect any Resources			

## 40.3 Using Authentication Schemes and Modules for Oracle Identity Federation 11g Release 1

An authentication scheme is a named component that defines the challenge mechanism required to authenticate a user. Each authentication scheme must also include a defined authentication module.

The following topics describe the authentication schemes and modules that are available for use with the Oracle Identity Federation server in Oracle Fusion Middleware Release 11g R1 (11.1.1).

See [Using Authentication Schemes and Modules for Identity Federation 11g Release 2 \(11.1.2.2\)](#) about any schemes that are used for Identity Federation in 11g Release 2 (11.1.2.3).

See [Managing Authentication Schemes](#) for additional information about schemes.

- [About Scheme OIFScheme](#)
- [About the OIFMTLDAPPlugin Authentication Module](#)
- [Managing Authentication with Oracle Identity Federation Release 11gR1](#)

### 40.3.1 About Scheme OIFScheme

OIFScheme and OIFMTScheme are used for integration with Oracle Identity Federation 11g Release 1 (11.1.1).

See [Using Authentication Schemes and Modules for Identity Federation 11g Release 2 \(11.1.2.2\)](#) for the schemes available with Identity Federation 11g Release 2 (11.1.2.3).

**Figure 40-5 OIFScheme**

**OIFScheme** Authentication Scheme Set As Default Duplicate Apply

An Authentication Scheme defines the challenge mechanism required to authenticate a user. Each Authentication Scheme must also include a defined Authentication Module.

\* Name: OIFScheme

Description: OIFScheme

\* Authentication Level: 2

Default:

\* Challenge Method: DAP

Challenge Redirect URL: /oam/server/

\* Authentication Module: DAP

\* Challenge URL: http(s)://OIFhost:port/fed/user/sposso

\* Context Type: external

Challenge Parameters: TAPPartnerId=OIFDAPPartner

[Table 40-4](#) describes the scheme OIFScheme.

**Table 40-4 OIFScheme Definition**

Element	Description
Name	This is the scheme name.
Description	This is a brief description of the scheme.
Authentication Level	This is the trust level of the authentication scheme.
Default	This is a non-editable box that is checked when the <b>Set as Default</b> button is clicked.
Challenge Method	Use to select a challenge method from those available in the drop-down box.
Challenge Redirect URL	This is the URL of another server to which user requests must be redirected for processing.
Authentication Module	This is the authentication module to use with the scheme.
Challenge URL	This is the URL the credential collector will redirect to for credential collection.
Context Type	Use this element to build the final URL for the credential collector.
Challenge Parameters	This is the list of parameters, if any, to use with the challenge.

[Table 22-21](#) for OIFScheme specifications.

## 40.3.2 About the OIFMTLDAPPlugin Authentication Module

The OIFMTLDAPPlugin module authenticates federated tenants through Identity Federation and non-federated tenants with the identity store associated with Access Manager.

**Figure 40-6 OIFMTLDAPPlugin**

**Authentication Module** Authentication Module Duplicate Apply

Custom Authentication Module relies on bundled plug-ins (or those that are developed using the Access Manager Authentication Extensibility Java API). This module uses more than one plug-in that you can orchestrate to ensure that each one performs a specific authentication function.

General **Steps** Steps Orchestration

View + × Detach

Step Name	Description	Plug-in Name
TAPAuthentication	TAP response authentica...	TAPUserAuthenticationPlugin
TenantDisambiguation	Plugin to disambiguate L...	TenantDisambiguationPlugin
LocalUserIdentification	Plugin to identify local user	UserIdentificationPlugin
LocalUserAuthentication	Plugin to authenticate loc...	UserAuthenticationPlugin
FederatedTAPRequestPl...	Plugin to send TAP reque...	TAPRequestPlugin

**Step Details** Save Cancel

Step Name TAPAuthentication

Description TAP response authentication plugin

Plug-in Name TAPUserAuthenticationPlugin

KEY\_CHECK\_TOKEN\_EXPIRY

KEY\_IDENTITY\_STORE\_REF

KEY\_USERNAME\_ATTRIBUTE

Table 40-5 lists the steps for OIFMTLDAPPlugin.

**Table 40-5 IFMTLDAPPlugin Steps**

Element	Description
Step Name	This is the name of the step within the module.
Description	This element contains a brief description of this step.
Plugin Name	This element specifies the plugin associated with this step.
Plugin Parameters	This element lists the parameters, if any, needed for plugin execution. The parameter list varies with the plugin.

## 40.3.3 Managing Authentication with Oracle Identity Federation Release 11gR1

When you manage authentication with Oracle Identity Federation Release 11gR1, you work with OIFScheme and OIFMTLDAPPlugin, a custom authentication module for Identity Federation 11g Release 1 (11.1.1).

The following topics explain how to manage authentication with Oracle Identity Federation Release 11gR1:

- [Prerequisites for Authentication with Oracle Identity Federation Release 11gR1](#)
- [Viewing or Modifying the OIFScheme Authentication Scheme](#)
- [Prerequisites for Viewing or Modifying the OIFMTLDAPPlugin Authentication](#)

- [Viewing or Modifying the OIFMTLDAPPlugin Authentication](#)
- [Adding an Authentication Policy with OIFScheme](#)

#### **40.3.3.1 Prerequisites for Authentication with Oracle Identity Federation Release 11gR1**

None

#### **40.3.3.2 Viewing or Modifying the OIFScheme Authentication Scheme**

You can search for the OIFScheme Authentication Scheme and modify the Scheme details as desired.

To view or modify the Authentication Scheme:

1. In the Oracle Access Management Console, click **Application Security** at the top of the window.
2. In the Application Security console, click **Authentication Schemes** in the **Access Manager** section.
3. Search for and open the OIFScheme authentication scheme.
4. Review OIFScheme details to ensure these are desired for your deployment.

See [Table 40-4](#) for field details.

5. Click **Save**.

#### **40.3.3.3 Prerequisites for Viewing or Modifying the OIFMTLDAPPlugin Authentication**

None.

#### **40.3.3.4 Viewing or Modifying the OIFMTLDAPPlugin Authentication**

You can search for the OIFMTLDAPPlugin Authentication and modify module details as desired.

To view or modify the OIFMTLDAPPlugin Authentication:

1. In the Oracle Access Management Console, click **Application Security** at the top of the window.
2. In the Application Security console, click **Authentication Modules** in the **Plug-ins** section.
3. Search for and open the OIFMTLDAPPlugin authentication module.
4. Review OIFMTLDAPPlugin details to ensure these are configured as desired for your deployment.

See [Table 40-5](#) for details.

5. Click **Save**.

#### **40.3.3.5 Adding an Authentication Policy with OIFScheme**

The procedure for this task is the same as described in the following topics:

See "[Adding an Authentication Policy with FederationScheme](#)".

## 40.4 Managing Access Manager Policies for Use with Identity Federation

The following topics explain how to use policy responses in Access Manager in the context of federation policies:

- [About Policy Responses with Assertion Attributes for Identity Federation](#)
- [Defining Policy Responses with Assertion Attributes for Identity Federation](#)

### 40.4.1 About Policy Responses with Assertion Attributes for Identity Federation

A policy can optionally include one or more authentication responses, or authorization responses, or both. You can configure the use of assertion attributes when setting up Access Manager policy responses with Identity Federation.

You use assertion attributes as follows:

- Authorization policy conditions
- Response attributes as HTTP headers
- Response attributes for identity context

[Figure 40-7](#) shows the Response configuration tab for an authorization policy:

**Figure 40-7 Authorization Policy Response Tab**

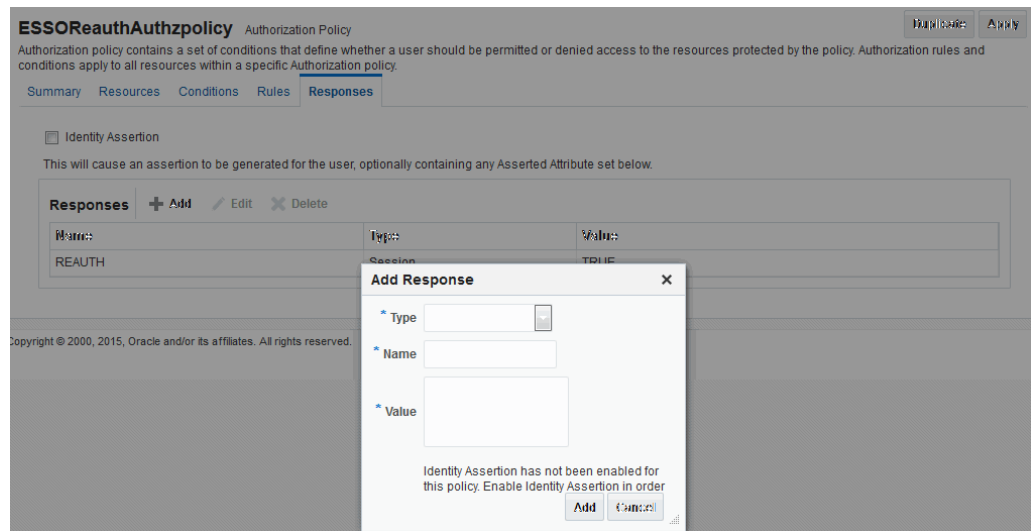

[Table 40-6](#) describes the elements for a policy response.

**Table 40-6 Policy Response Elements**

Element	Description
Name	This is a unique name to distinguish this response from other responses that use the same mechanism (type).
Type	This is the mechanism used to convey the response form of the action to be taken with the value string. Select Assertion Attribute.

**Table 40-6 (Cont.) Policy Response Elements**

Element	Description
Value	<p>This is the response expression, set as a variable. To provide the federation data as response attributes in the authentication or authorization policy, the values can reference:</p> <ul style="list-style-type: none"> <li>• <code>\$session.attr.fed.nameidvalue</code> for the name ID value</li> <li>• <code>\$session.attr.fed.attr.AttributeName</code> for any other assertion attribute</li> </ul>

## 40.4.2 Defining Policy Responses with Assertion Attributes for Identity Federation

You can use the Oracle Access Management Console to configure policy responses with assertion attributes.

- [Background on Conditions and Responses for Identity Federation](#)
- [Prerequisites for Viewing and Configuring Policy Responses with Assertion Attributes](#)
- [Viewing or Configuring Responses with Assertion Attributes](#)

### 40.4.2.1 Background on Conditions and Responses for Identity Federation

Identity Federation conditions and responses must be specified separately because they are used for different tasks.

For example, if the identity provider sends a role assertion and the service provider wanted to only allow people who had a role of `saLes` to gain access to the resource, you add a condition as follows:

- The Condition Namespace is "Session".
- The Name is "fed.attr.role".
- The Operator is set to EQUALS.
- Value is "sales".

A condition is used to control access to a resource within Access Manager.

---



---

**Note:**

- Replace the role in this example to the actual SAML asserted attribute.
  - If you want to use the standard SAML NameID value as the condition, then the value is "attr.fed.nameidvalue".
- 
- 

A response, on the other hand, enables you to pass an asserted attribute to the application. For example, if you wanted to pass the asserted attribute `role` to a back-end application in an HTTP header, you would:

- Go to the **Response** tab.

- Add a Header, name `Role` (this is the name of the HTTP header).
- The value would be `$session.attr.fed.attr.role`.

Then replace the role in this example to correspond to the SAML asserted attribute.

#### 40.4.2.2 Prerequisites for Viewing and Configuring Policy Responses with Assertion Attributes

None.

#### 40.4.2.3 Viewing or Configuring Responses with Assertion Attributes

To view or configure responses with assertion attributes:

1. Using the Oracle Access Management Console, search for the desired application domain and open the desired policy to view or configure a response.
2. Select the **Responses** tab.
3. Click the relevant icon to add, delete or update a response.
4. When updating, review the response details to ensure these are desired for your deployment.

See [Table 40-6](#) for details.

5. Click **Save**.

[Figure 40-8](#) shows an example of federation response attribute configuration.

**Figure 40-8 Adding a Federation Response Attribute to an AuthZ Policy**

The screenshot shows a dialog box titled "Add Response" with a close button (X) in the top right corner. It contains three main sections:

- \* Type:** A dropdown menu currently showing "Asserted Attribute".
- \* Name:** A text input field that is currently empty.
- \* Value:** A list box containing a scrollable list of federation response attributes. The first item, "oracle:idm:claims:client:antivirusenabled", is highlighted in blue. Other visible items include "oracle:idm:claims:client:fingerprint", "oracle:idm:claims:client:firewallenabled", "oracle:idm:claims:client:geolocation", "oracle:idm:claims:client:ipaddress", "oracle:idm:claims:client:jailbroken", "oracle:idm:claims:client:macaddress", "oracle:idm:claims:client:ostype", "oracle:idm:claims:client:osversion", "oracle:idm:claims:client:vpnenabled", "oracle:idm:claims:fed:attributes", "oracle:idm:claims:fed:nameidformat", "oracle:idm:claims:fed:nameidvalue", "oracle:idm:claims:fed:partner", "oracle:idm:claims:ids:attributes", "oracle:idm:claims:risk:fingerprint", "oracle:idm:claims:risk:level", "oracle:idm:claims:risk:newdevice", and "oracle:idm:claims:risk:safeforuser".

## 40.5 Testing Identity Federation Configuration

After performing the procedure that is described in the previous topic, you have completed all the steps to configure federation in SP mode.

To recap, these steps are:

1. Enabling the Identity Federation service using Oracle Access Management Console.
2. Creating an IdP partner or using an existing IdP partner.
3. Ensuring that IdP setup including SAML attributes, global logout, and nameID format are configured.
4. Configuring an authentication/authorization policy that uses `FederationScheme` with federation response attributes; and
5. Protecting a resource with this policy.

To test this configuration, access the resource that is protected by the authentication policy and verify that access is granted or denied according to the policy.

### 40.5.1 Test SP Module

Identity Federation provides a Test SP module that enables you to Test Federation SSO with an IdP Partner and view the result of the Federation SSO operation as well as the assertion sent by the Identity Provider.

#### 40.5.1.1 Enabling or Disabling the Test SP Module

You can enable or disable the Test SP Module.

1. Enter the WLST environment:

```
$OH/common/bin/wlst.sh
```

2. Connect to the Admin Server:

```
connect()
```

3. Move to the domain runtime location:

```
domainRuntime()
```

4. Execute the following WLST command to enable the Test SP Module:

```
configureTestSPEngine("true")
```

5. Execute the following WLST command to disable the Test SP Module:

```
configureTestSPEngine("false")
```

### 40.5.2 Accessing the Test SP Module and Performing a Federation SSO Operation

You can access the Test SP module and perform a federation SSO operation with an IdP partner.

1. Access the following service:

```
http(s)://oam-hostname:oam-port/oamfed/user/testspssso
```



2. Select the IdP with which to perform a federation SSO (*note*: only enabled IdP partners are listed).
3. Start the federation SSO operation. The browser will be redirected to the IdP Partner for authentication and redirected back to Identity Federation with a federation response.
4. Identity Federation will process the federation assertion and the Test SP module will display the result of the processing (*note*: no Access Manager session will be created as a result of the operation).

### 40.5.3 Troubleshooting Errors During Federation Configuration After an Upgrade

IAM Suite is the OOTB Application Domain created when OAM 11.1.2 is installed. This Application Domain can be renamed after installation but when upgrading OAM to 11.1.2.2.0, it must be renamed back to IAM Suite otherwise the upgrade operation will fail with the following error seen in the WLS admin logs.

```
java.lang.NullPointerException
at
oracle.security.am.common.policy.tools.upgrade.r2ps2.bootstrap.FedR2PS2BootstrapHandler.createFedAuthnResource(FedR2PS2BootstrapHandler.java:505)
at
oracle.security.am.common.policy.tools.upgrade.r2ps2.bootstrap.FedR2PS2BootstrapHandler.doBootstrap(FedR2PS2BootstrapHandler.java:151)
at
oracle.security.am.common.policy.tools.upgrade.r2ps2.bootstrap.R2PS2BootstrapHelper.doBootstrap(R2PS2BootstrapHelper.java:70)
at
oracle.security.am.common.policy.tools.PolicyComponentLifecycle.initialize(PolicyComponentLifecycle.java:99)
```

If the IAM Suite Application Domain has been renamed after installation, it is required to rename it back to its original IAM Suite name prior to beginning the upgrade process. After the upgrade process is complete, the name can be changed back to a custom name.

## 40.6 Using the Default Identity Provisioning Plug-in

11g Release 2 (11.1.2.3) features a plug-in that you can optionally use to provision a missing identity during a federated SSO operation.

The following topics describe how to use a provisioning plug-in:

- [Why Use a Provisioning Plug-in?](#)
- [About the Default Provisioning Plug-in](#)
- [Using the Default Provisioning Plug-in](#)
- [Switching to a Custom Provisioning Plug-in](#)

### 40.6.1 Why Use a Provisioning Plug-in?

When a federated SSO transaction is initiated, the processing flows as follows:

1. The IdP authenticates a user and sends an assertion to Oracle Access Management Identity Federation.

2. Acting as SP, Identity Federation maps the user to the local identity store.
  3. If the user does not exist in the local store, the mapping fails.
- Resolving this issue requires you to provision the user so the transaction can continue.

## 40.6.2 About the Default Provisioning Plug-in

To handle the identity mapping failure, Identity Federation supports the ability to set up a plug-in, known as the default provisioning plug-in, to provision the missing user in the identity store and enable the federated single sign-on to proceed.

The user is provisioned in the identity store associated with the IdP partner. You can specify a list of attributes to use in provisioning the plug-in, as explained in the next section.

## 40.6.3 Using the Default Provisioning Plug-in

You can enable this default provisioning plug-in from the plug-in configuration interface.

To use the default provisioning plug-in:

1. From the plug-in configuration interface select `FedUserProvisioningPlugin`.
2. In the configuration parameters tab, set the following parameters:
  - `KEY_USER_RECORD_ATTRIBUTE_LIST` - This is the list of attributes with which the user should be provisioned. These attributes are available as part of the assertion, for example: `mail`, `givenname`. (optional)
  - `KEY_PROVIDERID_ATTRIBUTE_NAME` - This is the tenant ID attribute name in the identity store which Identity Federation populates at run-time with the tenant name. (optional)
  - `KEY_USERID_ATTRIBUTE_NAME` - This is the attribute name to use for the `userid` value from the assertion attributes. (optional)
3. Enable user provisioning with the default plug-in by executing the WLST command:

```
putBooleanProperty("/fedserverconfig/userprovisioningenabled","true")
```

## 40.6.4 Switching to a Custom Provisioning Plug-in

A custom provisioning plug-in is also available with Identity Federation.

To switch from the default plug-in to the custom plug-in, follow the guidelines in *Developing a Custom User Provisioning Plug-in* chapter of the *Oracle Fusion Middleware Developer's Guide for Oracle Access Management*.

When you use the custom plug-in, set the plug-in name with the WLST command:

```
putStringProperty("/fedserverconfig/userprovisioningplugin","CustomPlugin")
```

## 40.7 Configuring the Identity Provider Discovery Service

Identity provider discovery is a service that selects an identity provider (possibly through interaction with the user) to use during SSO.

While Identity Federation does not provide an identity provider discovery service, it provides support for using such a service to select an IdP, if one is not passed in the authentication request to the SP during SP-initiated SSO.

See the following specifications about IdP discovery at:

<http://docs.oasis-open.org/security/saml/Post2.0/sstc-saml-idp-discovery-cs-01.pdf>

When acting as a service provider, Identity Federation can be configured so that if an SSO operation is initiated without the provider ID of the partner IdP, the user is redirected to an IdP discovery service to select the identity provider with which to perform SSO.

After the user selects an identity provider, the custom page resubmits the SSO request with the chosen IdP to Identity Federation.

See the following topics for details:

- [Configuring the Bundled IdP Discovery Service](#)
- [Configuring Identity Federation with a Custom IdP Discovery Service](#)
- [Disabling the use of an IdP Discovery Service](#)

### 40.7.1 Configuring the Bundled IdP Discovery Service

Identity Federation provides a simple Identity Provider Discovery Service that can be used to determine the Federation IdP Partner to be used at runtime during a Federation SSO operation.

To configure the bundled IdP discovery service:

1. Enter the WLST environment:

```
$OH/common/bin/wlst.sh
```

2. Connect to the Admin Server:

```
connect()
```

3. Move to the domain runtime location:

```
domainRuntime()
```

4. Execute the following WLST command to configure Identity Federation to use an IdP Discovery Service:

```
putBooleanProperty("/spglobal/idpdiscoveryserviceenabled", "true")
```

5. Execute the following WLST command to configure Identity Federation to use the default out-of-the-box IdP Discovery Service:

```
putBooleanProperty("/spglobal/idpdiscoveryservicepageenabled",
"true")putStringProperty("/spglobal/idpdiscoveryserviceurl", "/oamfed/
discovery.jsp")
```

### 40.7.2 Configuring Identity Federation with a Custom IdP Discovery Service

You can configure Identity Federation to interact with a custom IdP Discovery Service that is deployed remotely.

To configure Identity Federation with a custom IdP Discovery Service:

1. Enter the WLST environment:

```
$OH/common/bin/wlst.sh
```

2. Connect to the Admin Server:

```
connect()
```

3. Move to the domain runtime location:

```
domainRuntime()
```

4. Execute the following WLST command to configure Identity Federation to use an IdP Discovery Service:

```
putBooleanProperty("/spglobal/idpdiscoveryserviceenabled", "true")
```

5. Execute the following WLST command to configure Identity Federation to use a custom IdP Discovery Service (replace `IDP_DISCOVERY_SERVICE_URL` with the fully qualified URL of the Discovery Service):

```
putBooleanProperty("/spglobal/idpdiscoveryservicepageenabled", "false")
putStringProperty("/spglobal/idpdiscoveryserviceurl",
 "IDP_DISCOVERY_SERVICE_URL")
```

At runtime, Identity Federation redirects to the IdP Discovery Service page with the following parameters:

- `return`: This is the URL to which the page should send the new request containing the chosen IdP provider ID to Identity Federation.
- `returnIDParam`: This is the name of the parameter to use to specify the chosen IdP provider ID in the request sent to Identity Federation.

The discovery service receives the values of these parameters, displays a list of IdPs, and then sends a new request to Identity Federation specifying the chosen IdP Provider ID.

---

---

**Note:**

Make sure that the URL query parameter values are correctly URL-encoded.

---

---

### Example of an IdP Discovery Service Page

The following example represents an IdP discovery service page that enable a user to select an identity provider (from the list of provider IDs: <http://idp1.com>, <http://idp2.com>, <http://idp3.com>), and submit the chosen provider ID to Identity Federation to continue the SSO flow.

```
<%@ page buffer="5kb" autoFlush="true" session="false"%>
<%@ page language="java" import="java.util.*, java.net.*"%>

<%
// Set the Expires and Cache Control Headers
response.setHeader("Cache-Control", "no-cache");
response.setHeader("Pragma", "no-cache");
response.setHeader("Expires", "Thu, 29 Oct 1969 17:04:19 GMT");

// Set request and response type
request.setCharacterEncoding("UTF-8");
```

```

response.setContentType("text/html; charset=UTF-8");
String submitURL = request.getParameter("return");
String returnIDParam = request.getParameter("returnIDParam");

List idps = new ArrayList();
idps.add("http://idp1.com");
idps.add("http://idp2.com");
idps.add("http://idp3.com");

%>

<html>
 <title>
 Select an Identity Provider
 </title>
<body bgcolor="#FFFFFF"><form method="POST" action="<%=submitURL%>" id="PageForm"
name="PageForm" autocomplete="off">
 <center>
 <table cellpadding="5" cellspacing="2" border="0" width="500">
 <tr><td colspan="2" align="center">
 Select an Identity Provider
 </td></tr>
 <tr>
 <td align="right">Provider ID</td>
 <td>
 <select size="1" name="<%=returnIDParam%>">
<%
Iterator idpIT = idps.iterator();
while(idpIT.hasNext())
{
 String idp = (String)idpIT.next();
%>
 <option value="<%=idp%>"><%=idp%></option>
<%
}
%>
 </select>
 </td>
 </tr>
 <tr>
 <td colspan="2" align="center">
 <input type="submit" value="Continue"/>
 </td>
 </tr>
 </table>
 </center>
</form>
</body>
</html>

```

### 40.7.3 Disabling the use of an IdP Discovery Service

To disable the use of an IdP Discovery Service:

1. Enter the WLST environment:

```
$OH/common/bin/wlst.sh
```

2. Connect to the Admin Server:

```
connect()
```

3. Move to the domain runtime location:

```
domainRuntime()
```

4. Execute the following WLST command to configure Identity Federation to stop using an IdP Discovery Service:

```
putBooleanProperty("/spglobal/idpdiscoveryserviceenabled", "false")
putBooleanProperty("/spglobal/idpdiscoveryservicepageenabled", "false")
putStringProperty("/spglobal/idpdiscoveryserviceurl", "/oamfed/discovery.jsp")
```

## 40.8 Configuring the Federation User Self-Registration Module

When Identity Federation acts in Service Provider (SP) mode, the user assertion is mapped to a local user record in the LDAP directory to complete the federated single sign-on. If the mapping fails because the user performing the Federation SSO operation does not have a local account, Identity Federation can be configured to trigger a user self-registration flow to enable the user to create an account locally.

At runtime, when the Assertion mapping operation fails and if self-registration is enabled, the user self-registration framework:

- Redirects the user to a self-registration page.
- The self-registration page includes the following fields:
  - username
  - password
  - confirm password
  - first name
  - last name
  - email address

These fields may be pre-populated with data from the Assertion. Also, any field used in the Assertion Mapping process cannot be edited: the user will not be able to change the information used for the Assertion Mapping operation for security reasons.

- Once the user creates the account, the Federation SSO flow resumes and results You with the creation of an Access Manager session. At that point, the user will be redirected to the protected resource.

You can enable or disable the user self registration module.

### 40.8.1 Enabling or Disabling a User Self Registration Module

To configure the Federation User Self-Registration module:

1. Enter the WLST environment:

```
$OH/common/bin/wlst.sh
```

2. Connect to the Admin Server:

```
connect()
```

**3. Move to the domain runtime location:**

```
domainRuntime()
```

**4. Execute the following WLST command to enable the user self-registration module:**

```
putBooleanProperty("/fedserverconfig/userregistrationenabled", "true")
 putStringProperty("/fedserverconfig/userregistrationurl", "/oamfed/
registration.jsp")
```

**5. Execute the following WLST command to disable the user self-registration module:**

```
putBooleanProperty("/fedserverconfig/userregistrationenabled", "false")
 putStringProperty("/fedserverconfig/userregistrationurl", "/oamfed/
registration.jsp")
```

You can configure Identity Federation to pre-populate the fields of the self-registration page with the data that are included in the Assertion. By default, the self-registration page populates these fields based on the following registration properties:

If the attributes or NameID are missing from the assertion, the fields are empty.

- **first name:** Identity Federation will use either the `firstname` or `givenname` attributes contained in the Assertion. The `userregistrationfirstnameattr` configuration property indicates the list of comma separated attributes that should be used to populate this field. By default, that field is set to `firstname,givenname`.
- **last name:** Identity Federation will use either the `lastname` or `sn` attributes contained in the Assertion. The `userregistrationlastnameattr` configuration property indicates the list of comma separated attributes that you need to populate this field. By default, that setting is set to `lastname,sn`.
- **email address:** Identity Federation will use either the `mail` attribute contained in the Assertion, or the Assertion's NameID (referenced by `fed.nameidvalue`). The `userregistrationemailattr` configuration property indicates the list of comma separated attributes that should be used to populate this field. By default, that setting is set to `mail,fed.nameidvalue`.
- **username:** Identity Federation is not configured to use any Assertion attributes to populate this field. The `userregistrationusernameattr` configuration property indicates the list of comma separated attributes that should be used to populate this field. By default, that setting is empty.

## 40.8.2 Configuring User Registration Properties

To configure user registration properties:

**1. Enter the WLST environment:**

```
$OH/common/bin/wlst.sh
```

**2. Connect to the Admin Server:**

```
connect()
```

**3. Move to the domain runtime location:**

```
domainRuntime()
```

4. Execute the following WLST command to set the first name field rule:

```
putStringProperty("/fedserverconfig/userregistrationfirstnameattr",
"firstname,givenname")
```

5. Execute the following WLST command to set the last name field rule:

```
putStringProperty("/fedserverconfig/userregistrationlastnameattr", "lastname,sn")
```

6. Execute the following WLST command to set the email address field rule:

```
putStringProperty("/fedserverconfig/userregistrationemailattr",
"mail,fed.nameidvalue")
```

7. Execute the following WLST command to set the username field rule:

```
putStringProperty("/fedserverconfig/userregistrationusernameattr",
"uid,fed.nameidvalue")
```

## 40.9 Integrating OAM Identity Provider With Microsoft Office 365 Service Provider

The following topics describe how to administer OAM Identity Federation 11g R2PS2 (11.1.2.2.0) as an IdP for integration with Microsoft Office 365 when the latter is configured as an SP leveraging the SAML 2.0 standard. After the integration implementation, you can use an account in the Identity Repository to access all web clients (including Office rich client apps connecting to SharePoint Online) and email-rich clients that use basic authentication and a supported Exchange access method such as IMAP, POP, Active Sync or MAPI. (The Enhanced Client Protocol end point is required to be deployed).

The deployment assumes that:

1. OAM 11gR2PS2 has been installed and configured using SSL.
2. An account has been created using the Oracle Access Management Console that defines the Administrator role for Office 365.
3. Windows PowerShell 2.0 and Microsoft Online Services Module have been installed.
4. An available domain name can be used as the federated domain in Office 365. Generally, this domain needs to be purchased.

---

---

**Note:**

For non Web-based client integration:

- The OAM IdP endpoint must be accessible from the public network.
  - A trusted SSL certificate issued by a well known entity must be used.
- 
- 

The following topics provide configuration details:

- [Configuring Microsoft Office 365 for OAM Integration](#)
- [Configuring OAM for Microsoft Office 365 Integration](#)



- [Configuring Microsoft Office 365 for OAM Integration](#)

## 40.9.1 Configuring Microsoft Office 365 for OAM Integration

To configure Microsoft Office 365 for OAM integration:

1. Add the domain name (for example, test.com) and verify it using the Office 365 Web administration center.
2. Define the authentication scheme for the domain as Federated by running the Set-MsolDomainAuthentication PowerShell command.

```
$dom="<domain name>"
$url="https://server_host:port/oamfed/idp/samlv20"
$uri="<entityID>"
$secpUrl=https:// server_host:port/oamfed/idp/soap
$logourl="https://server_host:port/oamfed/idp/samlv20"
$cert="MIIB/DCCAWWgAwIBAgI....."
Set-MsolDomainAuthentication -FederationBrandName $dom
-Authentication Federated -ActiveLogUri $secpUrl -PassiveLogOnUri $url
-SigningCertificate $cert -IssuerUri $uri
-LogOffUri $logourl -PreferredAuthenticationProtocol SAML
```

---



---

### Note:

The values for some of these parameters can be found in the OAM Identity Provider metadata.

---



---

3. Create a user in the Federated domain by running the New-MsolUser PowerShell command.

```
New-MsolUser -DisplayName <name> -UserPrincipalName
<name@domain_name> -UsageLocation <location>
-BlockCredential $false -ImmutableId <immutableid>
```

Values for UserPrincipalName and ImmutableId are required by Office 365 for Federation. In the SAML assertion, the value of ImmutableId will be stored in the SAML Subject using the "urn:oasis:names:tc:SAML:2.0:nameid-format:persistent" NameID format. The UserPrincipalName will be stored in the SAML Attribute using the attribute name IDPEmail. In the OAM User Identity Store, the user entry must use the same attributes to store the values of UserPrincipalName and ImmutableId. Use the following:

- mail=<name@domain\_name (UserPrincipalName)>
- uid=<immutableid>

---



---

### Note:

If Office 365 has been before this integration, you can use an existing user for testing. You must know the values of the UserPrincipalName and ImmutableId attributes for the existing user.

---



---

4. Assign a license to the user to make the applications provided by Office 365 available to the user.

## 40.9.2 Configuring OAM for Microsoft Office 365 Integration

The following topics describe how to configure OAM for integration with Microsoft Office 365:

- [Configuring for Web and Non-Web Clients](#)
- [Additional Configurations for Non-Web Clients](#)

See *Identity Federation WLST Commands* for details on how to use the WLST commands.

### 40.9.2.1 Configuring for Web and Non-Web Clients

To configure for Web and non-Web clients:

1. Log in to the Oracle Access Management Console.
2. Navigate to Available Services and enable the Identity Federation service.
3. Navigate to Identity Provider Administration.
4. Create a Service Provider Attribute Profile mapping.

**Table 40-7 Message Attribute Mapping**

Message Attribute Name	Value	Always Send
IDPEmail	\$user.attr.mail	true

5. Create a Service Provider Partner for Office 365 using the attributes and values.

See [Table 40-8](#) for details.

**Table 40-8 Office 365 Service Provider Attribute Values**

Provider Attribute	Value
Name	Office365
Protocol	SAML 2.0
Service Details	Load from provider metadata
Metadata File	Can be downloaded from: <a href="https://nexus.microsoftonline-p.com/federationmetadata/saml20/federationmetadata.xml">https://nexus.microsoftonline-p.com/federationmetadata/saml20/federationmetadata.xml</a> For customers in China using the China-specific instance of Office 365 download from: <a href="https://nexus.partner.microsoftonline-p.cn/federationmetadata/saml20/federationmetadata.xml">https://nexus.partner.microsoftonline-p.cn/federationmetadata/saml20/federationmetadata.xml</a>
NameID Format	persistent
NameID Value	User ID Store Attribute + uid
Attribute Mapping Profile	The profile created in step 2
User Identity Store	Identity Store used

**Table 40-8 (Cont.) Office 365 Service Provider Attribute Values**

Provider Attribute	Value
User Search Base DN	The base DN for User search
SSO Response Binding	HTTP POST

- Optionally, set the default Authentication Scheme for the service provider partner using the `setSPPartnerDefaultScheme WLST` command.

By default, OAM uses `LDAPScheme` for user authentication. To use another scheme, run the following command:

```
setSPPartnerDefaultScheme(<partner>, <authnScheme>)
```

See [Additional Configurations for Non-Web Clients](#) if you use non-Web clients.

#### 40.9.2.2 Additional Configurations for Non-Web Clients

Perform these additional configurations if using non-Web clients. These steps will not impact Web-based integration.

- Use the `setSPPartnerAlternateScheme WLST` command to set an alternative Authentication Scheme for the Service Provider partner to handle HTTP Basic authentication. For example:

```
setSPPartnerAlternateScheme(<partner>, "true",
 httpHeaderName="X-MS-Client-Application", httpHeaderExpression=".*
 Microsoft.Exchange.*", authnScheme="BasicScheme or BasicSessionlessScheme")
```

The values of `httpHeaderName` and `httpHeaderExpression` can be determined from the HTTP request sent from Office365 to OAM. If you want to use other values, use rich clients to connect the email account and capture the HTTP request on OAM server side.

---



---

#### Note:

It is recommended to use `BasicSessionlessScheme` because Office 365 only validates user credentials to get an assertion.

---



---

- Use the `updatePartnerProperty WLST` command to update the configuration to send certificates in XML signatures.

```
updatePartnerProperty(<partner>,"sp","includecertinsignature","true","boolean")
```

For Basic Authentication, you may need re-authentication even after the Request is already authenticated.

### 40.9.3 Verifying Federation Single Sign-On

The following topics explain how to verify Federation SSO:

- [Verifying SP-Initiated SSO](#)
- [Verifying IDP-Initiated SSO](#)
- [Verifying Federation with Non Web-based Clients](#)

### 40.9.3.1 Verifying SP-Initiated SSO

To verify SP-initiated SSO:

1. Open one of the following URLs.
  - <http://portal.microsoftonline.com>: from login page, input "xxx@test.com" in the user name field, then click the password field; at this time, you should be automatically redirected to the OAM login page.
  - <http://www.outlook.com/test.com>: you should be automatically redirected to the OAM login page.
2. Enter a user name and password in the displayed OAM login page and click Login.

If SSO is successful, you are then logged into the Office 365 Web portal.

### 40.9.3.2 Verifying IDP-Initiated SSO

To verify IDP-initiated SSO:

1. Open <http://host:port/oamfed/idp/initiatesso?providerid=urn:federation:MicrosoftOnline&returnURL=http://portal.microsoftonline.com> in a browser.
2. Enter a user name and password in the displayed OAM login page and click Login.

If SSO is successful, you will be logged into the Office 365 Web portal.

### 40.9.3.3 Verifying Federation with Non Web-based Clients

To verify federation with non Web-based clients:

1. Add an Email account for an email client.
  - For Desktop Email client like Outlook client, please refer to <http://help.outlook.com/en-ca/140/cc875899.aspx>
  - For Native Email app in Android device, please refer to <http://office.microsoft.com/client/15/help/preview?AssetId=HA102823196&lcid=1033&NS=O365ENTADMIN&Version=15&CTT=5&origin=HA103787372>
  - For IOS device, please refer to <http://office.microsoft.com/client/15/help/preview?AssetId=HA102818554&lcid=1033&NS=O365ENTADMIN&Version=15&CTT=5&origin=HA102828259>

---

---

**Note:**

When adding an email account using the Outlook client, after you input Your Name and Email Address in the User Information area, it auto-fills the User Name value in the Logon Information area with the value of Your Name. It is recommended that you change the value of Your Name to reflect the email address.

---

---

2. Check that you can send and receive email successfully.



# Part X

---

## Managing Oracle Access Management Security Token Service

Administrators manage the Security Token Services available with Oracle Access Management to simplify the effort needed to bridge access to various systems by using a standardized set of interfaces.

This section contains the following chapters:

- [Introducing the Oracle Access Management Security Token Service](#)
- [Security Token Service Implementation Scenarios](#)
- [Configuring Security Token Service Settings](#)
- [Managing Security Token Service Certificates and Keys](#)
- [Managing Templates, Endpoints, and Policies](#)
- [Managing Token Service Partners and Partner Profiles](#)
- [Troubleshooting Security Token Service](#)





---

# Introducing the Oracle Access Management Security Token Service

The Oracle Access Management Security Token Service provides the foundation for the security infrastructure, facilitating a consistent and streamlined model for token acquisition, renewal, and cancellation that is protocol and security infrastructure agnostic.

It helps simplify the effort needed to bridge access to various systems by using a standardized set of interfaces. Security Token Service facilitates Federated SSO and Single Logout (SLO) for users accessing resources through a Web browser and across different security domains or administrative boundaries.

The following topics include information about the Security Token Service.

- [About the Security Token Service](#)
- [Using the Security Token Service](#)
- [About Security Token Service Key Terms and Concepts](#)
- [Integrating the Oracle Web Services Manager](#)
- [About the Architecture of the Security Token Service](#)
- [Security Token Service Supported Token Matrix](#)
- [Deploying Security Token Service](#)
- [About the Installation of the Security Token Service](#)
- [Administering the Security Token Service](#)

## 41.1 About the Security Token Service

Security Token Service is a Web Service (WS) Trust-based token service that allows for policy-driven trust brokering and secure identity propagation and token exchange between Web Services.

Security Token Service can be deployed as a Security and Identity Service and used to simplify the integration of distributed or federated Web services within an enterprise and its service providers.

---

**Note:**

Security Token Service is primarily based on the OASIS WS-Trust protocol but it also delegates the processing of other WS-\* protocols present in the SOAP message.

---

Security Token Service brokers trust between a Web Service Consumer (WSC) and a Web Service Provider (WSP) and provides security token lifecycle management services to both. It allows for the use of various federation protocols like SAML, WS-Federation, Liberty, or OpenID. The Oracle Access Management Security Token Service (Security Token Service) is deployed with Access Manager and must be activated as a service.

## 41.2 Using the Security Token Service

Each Managed Server must be registered with Access Manager to open communication channels. Security Token Service leverages the common infrastructure for shared services and the Access Manager 11g administration model. All Security Token Service system configuration is done using the Oracle Access Management Console, providing a unified and consistent administration experience. Security Token Service also inter-operates with third party security token servers.

Security Token Service is compliant and co-exists with Access Manager (using Access Manager as the primary authenticator for Web clients requesting tokens). Security Token Service also uses Oracle Web Services Manager Agents. WebGate is used as an Agent for identity propagation. The WebGate must be registered with Access Manager 11g to open a communication channel. Security Token Service processing:

- Integrates with STS Audit events
- Publishes, in the Oracle Access Management Console and WLST scripts, available Security Token Service methods to manage partner data
- Performs validation operations specific to the Security Token Service use cases and configuration model

---

---

**Note:**

Security Token Service adopts the same frameworks, guidelines, and practices for diagnostics, monitoring, auditing, and high availability used by Oracle Access Management 11g.

See [Logging, Auditing, Reporting and Monitoring Performance](#).

---

---

The Security Token Service 11g infrastructure is described in [Table 41-1](#).

**Table 41-1 Security Token Service 11g Infrastructure**

Component	Description
Default Trust Keystore	<p>Security Token Service private keys used for Signing/Encryption are stored in the common keystore used with Access Manager. Security Token Service and Access Manager use the common infrastructure certification validation module. Trusted Certificates and Certificate Revocation Lists (CRLs) used during certificate validation are stored in Trust Keystore and CRL ZIP file. The Security Token Service configuration stores the OCSP/CDP settings.</p> <p>The token security key pair is populated to Access Manager/Security Token Service keystore.</p> <p>Note: When the Oracle WSM Agent is used as the WS_Trust client in the Security Token Service deployment, Oracle strongly recommends that the Oracle WSM Agent keystore and the Security Token Service/Access Manager keystore always be different. Do not merge the two. Otherwise, Access Manager/Security Token Service keys could be available to any modules authorized by OPSS to access the keystore and Access Manager keys might be accessed.</p> <p>See Also: <a href="#">Access Manager Keystores</a>.</p>
Default User Identity Store	<p>Security Token Service authenticates and maps users against the User Identity stores configured through the Common Configuration section of System Configuration in the Oracle Access Management Console. Security Token Service maps the incoming token to user records and attributes in the default User Identity Store, which operates with both Access Manager and Security Token Service.</p> <p>See Also: <a href="#">About using the System Store for User Identities</a>.</p>
Certificates	<p>The certificates used by Security Token Service are self signed. The subject and the issuer field are identical. Out of the box, the OAM Server hosting Security Token Service is uniquely identified:</p> <ul style="list-style-type: none"> <li>• The keys and certificates used in Security Token Service are generated during installation. The subject and issuer fields are linked to the host name. This applies to the signing and encryption keys and certificates used by Security Token Service, as well as the keys/certificates used by the OWSM Agent protecting Access Manager. The OWSM Agent is the certified WS-Trust client that can be used to communicate with Security Token Service.</li> <li>• The SAML Issuer settings are configured to refer to the host name of the local computer.</li> </ul> <p>This ensures that two servers are not identical in terms of cryptographic materials and identifiers. The trust granted to one server by third-party modules is not granted to the other server because the identifiers and cryptographic keys differ. There are no identical keys, no identical identifiers, and authorization policies are in denial mode.</p>
Oracle Coherence	<p>Security Token Service integrates with the Oracle Coherence module to store and share run time WS-Trust data across all the physical instances of Security Token Service. The UserNameToken Nonce are stored in the Coherence store. This implementation supports the following requirements, which might be specific to Security Token Service:</p> <ul style="list-style-type: none"> <li>• Cleanup of timed out records</li> <li>• Existence of the records limited to several minutes (&lt; 30)</li> </ul>

### 41.3 About Security Token Service Key Terms and Concepts

Security tokens contain claims or statements that are used to assert trust. To secure communication between a Web service client and a Web service, the two parties must exchange security credentials. These credentials can be obtained from a trusted Security Token Service.

**Note:**

To provide interoperable security tokens, the Security Token Service must be trusted by both the Web service client and the Web service.

Modern IT environments have numerous types of security tokens (most of them based on browser cookies) for facilitating SSO and session management for Web applications. These token types include Kerberos (primarily for Windows Native Authentication), Security Assertion Markup Language (SAML) assertions, and even digital certificates.

Table 41-2 identifies common Security Token Service terminology.

**Table 41-2 Security Token Service Terms**

Term	Description
Security Token	<p>A security mechanism that protects messages using a token issued by a trusted Secure Token Service for message integrity and confidentiality protection. The issued tokens contain a key, which is encrypted for the server and which is used for deriving new keys for signing and encrypting.</p> <p>Service providers and consumers in potentially different managed environments can use a single Security Token Service to establish a chain of trust. The service does not trust the client directly, but instead trusts tokens issued by a designated Security Token Service. The Security Token Service is taking on the role of a second service with which the client must securely authenticate.</p>
Security Token Service	A trusted third party in an explicit trust relationship with the server (and a trust relationship with the client). Security Token Service is one example.
Secure Token Service	<p>A shared Web service that provides a standards-based consolidated mechanism of trust brokerage between different identity domains and infrastructure tiers.</p> <p>The service implements the protocol defined in the WS-Trust specification by making assertions based on evidence that it trusts, to whoever trusts it (or to specific recipients). This protocol defines message formats and message exchange patterns for issuing, renewing, canceling, and validating security tokens.</p> <p>To communicate trust, a service requires something to prove knowledge of a security token or set of security tokens. An XML Signature binds the sender's identity (or "signing entity") to an XML document, for example. The document is signed using the sender's private key, the signature is verified using the sender's public key.</p>
Request Security Token (RST)	Request for a security token.
Request Security Token Response (RSTR)	Response generated by Security Token Service in response to the Request for Security Tokens with claims for the requested user.
On Behalf Of (OBO)	<p>An OBO Request Security Token (RST) is used when only the identity of the original client is important. An OBO RST indicates that the requestor wants a token containing claims about only one entity:</p> <ul style="list-style-type: none"> <li>the external entity represented by the token in the <code>OnBehalfOf</code> element.</li> </ul>

**Table 41-2 (Cont.) Security Token Service Terms**

Term	Description
ActAs	<p>An ActAs RST requires composite delegation. The final recipient of the issued token can inspect the entire delegation chain (not just the client). An ActAs RST indicates that the requestor wants a token that contains claims about distinct entities:</p> <ul style="list-style-type: none"> <li>• The requestor</li> <li>• An external entity represented by the token in the ActAs element</li> </ul>
Token Exchange	<p>The exchange of one security token for another. The requestor (in order to invoke a web service) requires a particular token. It uses Security Token Service to exchange the incoming token with a token required by the service.</p>
WS-Security	<p>Web Services Security (WS-Security) specifies SOAP security extensions that provide confidentiality using XML Encryption and data integrity using XML Signature.</p> <p>The most prevalent security tokens used with WS-Security are Username, X.509 Certificates, SAML assertions, and Kerberos tickets (all supported by Oracle Web Service Manager).</p> <p>WS-Security also includes profiles that specify how to insert different types of binary and XML security tokens in WS-Security headers for authentication and authorization purposes:</p> <p>WS-* specifications often depend on each other. For example, WS-Policy is used in conjunction with WS-Security. WS-* specifications also leverage non-WS-* specifications; for example, WS-Security uses XML Encryption and XML Signature. For WS-Security, only SAML assertions are used. The protocols and bindings are provided by the WS-Security framework.</p> <p><b>Note:</b> WS-Security, WS-Trust, WS-Policy have been transferred over to standards bodies such as the Organization for the Advancement of Structured Information Standards (OASIS) or the World Wide Web Consortium (W3C).</p>
WS-Trust	<p>Web Services Trust Language (WS-Trust) is a specification that uses the secure messaging mechanisms of WS-Security to facilitate trust relationships.</p> <p>WS-Trust defines a request and response protocol that enables applications to construct trusted SOAP message exchanges. Trust is represented through the exchange and brokering of security tokens.</p> <p>In a message exchange using WS-Security only, it is assumed that both parties involved in the exchange have a prior agreement on which type of security tokens they must use for sharing security information. However, there are cases where these parties do not have such an agreement, as a result trust must be established before exchanging messages. Trust between two parties exchanging SOAP / WS-Security-based messages is established by implementing the WS-Trust specification.</p>
WS-Policy	<p>Web Services Policy (WS-Policy). Together with WS-Security, WS-Policy is another key industry standard for Oracle Fusion Middleware security.</p> <p>WS-Policy is used in conjunction with WS-Security. A web service provider may define conditions (or policies) under which a service is to be provided. The WS-Policy framework enables one to specify policy information that can be processed by web services applications, such as Oracle Web Services Manager.</p> <p>A policy is expressed as one or more policy assertions representing a web service's capabilities or requirements. For example, a policy assertion may stipulate that a request to a web service be encrypted. Likewise, a policy assertion can define the maximum message size that a web service can accept.</p>

**Table 41-2 (Cont.) Security Token Service Terms**

Term	Description
Certificates	The certificates used by Security Token Service are self signed. The subject and the issuer field are identical. Out of the box, the OAM Server hosting Security Token Service is uniquely identified:
Keystore	Security Token Service key stores include: <ul style="list-style-type: none"> <li>• System Keystore</li> <li>• Trust Keystore</li> <li>• Partner Keystore</li> </ul> See Also: <a href="#">Managing Security Token Service Certificates and Keys</a>
User Name Token (UNT)	Identifies the requestor by their username, and optionally using a password (or shared secret, or password equivalent) to authenticate that identity. When using a username token, the user must be configured in the Default User Identity Store.,
X.509 Certificates	A signed data structure designed to send a public key to a receiving party. A certificate includes standard fields such as certificate ID, issuer's Distinguished Name (DN), validity period, owner's DN, owner's public key, and so on. Certificates are issued by certificate authorities (CA), for example Verisign. A CA verifies an entity's identity and grants a certificate, signing it with the CA's private key. The CA publishes its own certificate which includes its public key. Each network entity has a list of the certificates of the CAs it trusts. Before communicating with another entity, a given entity uses this list to verify that the signature of the other entity's certificate is from a trusted CA.
Security Assertion Markup Language (SAML) SAML Assertion	An open framework for sharing security information on the Internet through XML documents. SAML provides: <ul style="list-style-type: none"> <li>• Assertions that define authentication and authorization information.</li> <li>• Protocols to ask (SAML Request) and get (SAML Response) the assertions you need.</li> <li>• Bindings that define how SAML Protocols ride on industry-standard transport (HTTP for instance) and messaging frameworks (SOAP for instance).</li> <li>• Profiles that define how SAML Protocols and Bindings combine to support specific use cases.</li> </ul> For WS-Security, only SAML assertions are used. However, the protocols and bindings are provided by the WS-Security framework. SAML assertions can include three types of statements: <ul style="list-style-type: none"> <li>• Authentication statement: issued by an authentication authority upon successful authentication of a subject. It asserts that Subject S was authenticated by Means M at Time T.</li> <li>• Attribute statement: issued by an attribute authority, based on policies. It asserts that Subject S is associated with Attributes A, B, etc. with values a, b, and so on.</li> <li>• Authorization decision statement (deprecated in SAML 2.0, now supported by XACML): issued by an authorization authority which decides whether to grant the request by Subject S, for Action A (read, write, and so on.), to Resource R (e.g., a file, an application, a web service), given Evidence E.</li> </ul>

**Table 41-2 (Cont.) Security Token Service Terms**

Term	Description
Kerberos	<p>A cross-platform authentication and single sign-on system. The Kerberos protocol provides mutual authentication between two entities relying on a shared secret (symmetric keys). Kerberos authentication requires a client, a server, and a trusted party to mediate between them called the Key Distribution Center (KDC). Also required:</p> <ul style="list-style-type: none"> <li>• A Principal: An identity for a user (a user is assigned a principal), or an identity for an application offering Kerberos services.</li> <li>• A Realm is a Kerberos server environment, which can be a domain name such as EXAMPLE.COM (by convention expressed in uppercase). Each Kerberos realm has at least one Web Services Security KDC.</li> </ul> <p>The Kerberos Token profile of WS-Security allows business partners to use Kerberos tokens in service-oriented architectures (SOAs).</p>

## 41.4 Integrating the Oracle Web Services Manager

In the 11g release, Oracle Web Services Manager (WSM) security and management has been integrated into the Oracle WebLogic Server along with Oracle WSM Agent functionality.

[Table 41-3](#) describes the WSM components.

See [Access Manager Security Keys and the Embedded Java Keystore](#).

**Table 41-3 Integrated Oracle Web Services Manager**

Component	Description
Java Keystore (JKS)	<p>Required to store the signature and encryption keys required by the X.509 token on the client. JKS the proprietary keystore format defined by Sun Microsystems. Trusted certificates and public and private keys are stored in the keystore. To create and manage the keys and certificates in the JKS, use the keytool utility. Keys are used for a variety of purposes, including authentication and data integrity.</p> <p>If the client and Web service are in the same domain with access to the same keystore, they can share the same private/public key pair:</p> <ul style="list-style-type: none"> <li>• The client can use the private key <code>orakey</code> to endorse the signature of the request message and the public key <code>orakey</code> to encrypt the symmetric key.</li> <li>• The Web service in turn uses the public key <code>orakey</code> to verify the endorsement, and the private key <code>orakey</code> to decrypt the symmetric key.</li> </ul>
Policy Interceptors	<p>In Oracle Fusion Middleware 11g, Oracle WSM Agents are managed by the security and management policy interceptors. Policy Interceptors enforce policies, including reliable messaging, management, addressing, security, and Message Transmission Optimization Mechanism (MTOM). The Oracle WSM Agent manages the enforcement of policies using the Policy Interceptor Pipeline.</p> <p>For complete Oracle Web Services Manager details, including the differences between release 10g and 11g, see <i>Oracle Fusion Middleware Security and Administrator's Guide for Web Services</i>.</p>

**Table 41-3 (Cont.) Integrated Oracle Web Services Manager**

Component	Description
Oracle WSM Agent	<p>The OWSM agent is the certified WS-Trust client that can be used to communicate with Security Token Service. The OWSM agent is <i>embedded</i> and used by Security Token Service for message protection only (to publish WS Policy and to enforce message protection on inbound and outbound WS messages). Security Token Service performs token validation/request authentication.</p> <ul style="list-style-type: none"> <li>• Security Token Service embedded Oracle WSM Agent is used in the mode of "Message Protection Only" with authentication functionality disabled. This way all aspects related to authentication of incoming token are performed by Security Token Service only.</li> <li>• Oracle WSM supports disabling of authentication using configuration overrides that Security Token Service must declare with each policy. Exception: The Kerberos token is handled by Oracle WSM and Security Token Service is involved in mapping only the identity.</li> <li>• The OWSM Agent is one of the certified WS-Trust clients that can be used to communicate with Security Token Service. Other 3rd party WS-Trust clients can be used to interact with Security Token Service.</li> </ul> <p>Note: Embedded means that the OWSM Agent is available as part of the JRF layer on the WebLogic Server that Security Token Service uses:</p>
Message/Token Protection	<p>Security Token Service/ Access Manager manages its own keystore and trust store. For Oracle WSM to enforce message protection for Security Token Service, the OWSM key store is seeded with its own self-signed certificate; passwords for its corresponding keys are stored in CSF. It does not work with Security Token Service keystore.</p> <p>Note: Conversely, Oracle WSM requires Access Manager/Security Token Service to store keys related to message protection in the OPSS Keystore. For cases where the client uses schemes such as SKI, Thumbprint, and so on to refer to its certificate, Oracle WSM requires that client certificate(s) are present in the OPSS Keystore.</p>
Token Signing Key	<p>Security Token Service has strong security requirements around its token signing key and uses the token signing key to broker trust between a client and a relying party. Therefore, this key must be stored in an exclusive partition that only Security Token Service can access.</p>
Security Key Pairs	<p>Security Token Service creates separate key pairs for issued token security and message security to provide security of token signing keys and eliminate the need for Oracle WSM agents to work with Access Manager/Security Token Service keystore:</p> <ul style="list-style-type: none"> <li>• The message security key pair is populated to OPSS Keystore</li> <li>• The token security key pair is populated to Access Manager/Security Token Service keystore</li> </ul>
OPSS Keystore	<p>The message security key pair is populated to OPSS Keystore. For special cases where clients use referencing schemes such as SKI (not a certificate token being received as part of the Web service request), Security Token Service populates OPSS Keystore with the requesting party's certificates. This is an uncommon scenario. Security Token Service can provide instructions on manually provisioning the keys to OPSS keystore to make it work.</p>



## 41.5 About the Architecture of the Security Token Service

Security Token Service is a centralized token service that supports WS-Trust protocol. It also defines extensions to the WS-Security specification for issuing and exchanging security tokens and establishing trust relationships. The Security Token Service is hosted as a web service endpoint and coordinates security based interactions between a WSC and a WSP.

Figure 41-1 shows all communication with the Security Token Service occurs through a WS\_Trust client.

**Figure 41-1 Security Token Service Architecture**

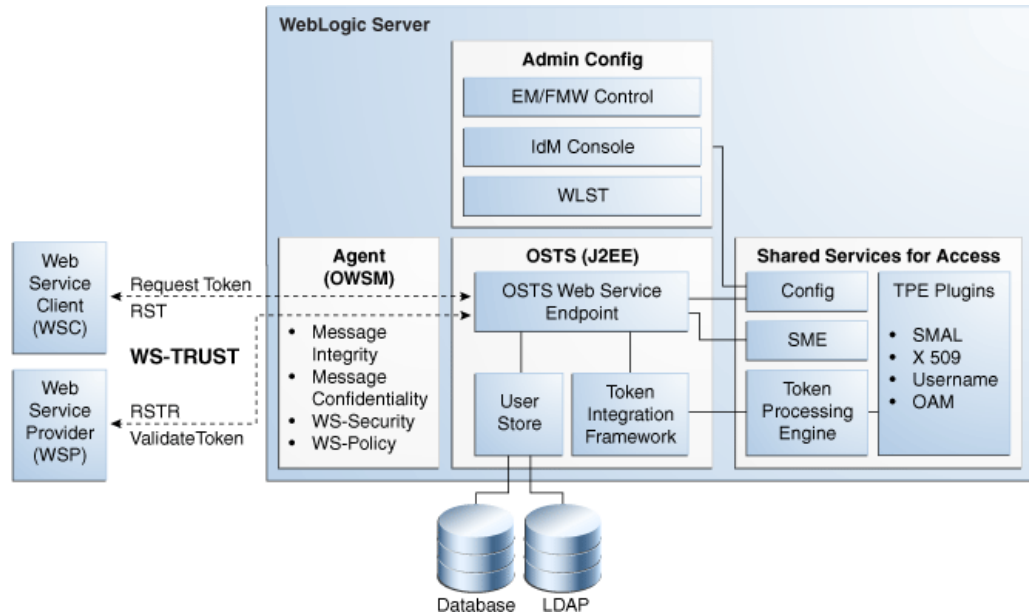

When a WSC makes a call to the WSP, it gets the WS-Security policy that indicates that a security token issued by Security Token Service should be presented. The policy includes the location of the Security Token Service. The WSC uses that location to contact the Security Token Service to retrieve the token expected by the WSP. (Alternately, the WSP could register its acceptable security mechanisms with the Security Token Service and, before validating the incoming SOAP request, check with the Security Token Service to determine its security mechanisms).

When an authenticated WSC (carrying credentials that confirm either the identity of the end user or the application) requests a token for access to a WSP, the Security Token Service verifies the credentials and, in response, issues a security token that provides proof that the WSC has been authenticated. The WSC presents the security token to the WSP which verifies that the token was issued by a trusted Security Token Service.

## 41.6 Security Token Service Supported Token Matrix

Here is the the token support matrix for Security Token Service.

Figure 41-2 documents the token support matrix for Security Token Service.

**Figure 41-2 Security Token Service Token Support**

Requester / WSC	"On Behalf Of" (End user's tokens)	Output Token
<ul style="list-style-type: none"> <li>• UserName</li> <li>• X509</li> <li>• Kerberos</li> <li>• SAML 1.1</li> <li>• SAML 2.0</li> </ul>	<ol style="list-style-type: none"> <li>1. UserName with password</li> <li>2. UserName without password</li> <li>3. X.509</li> <li>4. Kerberos</li> <li>5. SAML 1.1 / 2.0</li> <li>6. OAM Session Propagation token</li> <li>7. Custom token</li> </ol>	<ul style="list-style-type: none"> <li>• UserName without password</li> <li>• SAML 1.1</li> <li>• SAML 2.0</li> <li>• Custom token</li> </ul>

## 41.7 Deploying Security Token Service

The following topics describe the deployment options in detail:

- [About the Centralized Token Authority Deployment](#)
- [About Tokens Behind a Firewall Deployment](#)
- [About Web Services SSO Deployment](#)

---



---

**See Also:**

["Scenario: Identity Propagation with the Access Manager Token"](#)

---



---

### 41.7.1 About the Centralized Token Authority Deployment

The need for a token exchange for security integration between Web SSO and Web service security tiers is in demand in a deployment where a Web application makes internal or external Web service calls.

An example of this is an intranet portal integration with an external Web service provided by a partner or another organization within the same company. The portal needs a way to securely access the service but the difficulty of security integration in this case stems from the fact that the Web SSO tier and WS tier use different methods of user authentication.

In the Web SSO environment, the Web application can accept WAC-issued session tokens (SMSESSION, OBSSO), SAML assertions or proprietary tokens to authenticate the users. The WS\* security tier also uses a variety of standard and proprietary tokens and, in most cases, local translation of token is required to achieve integration between the two tiers. Additionally, the WS performing the translation must contact the authority by which the token was issued (Oracle Adaptive Access Manager) to decompose the token before it can be translated. Decomposition requires every WS service to maintain trust with WAC systems; this is complex and not very secure because of multiple trust links that need to be maintained.

[Figure 41-3](#) shows the translation of tokens can be done at the centralized authority with the introduction of Security Token Service.

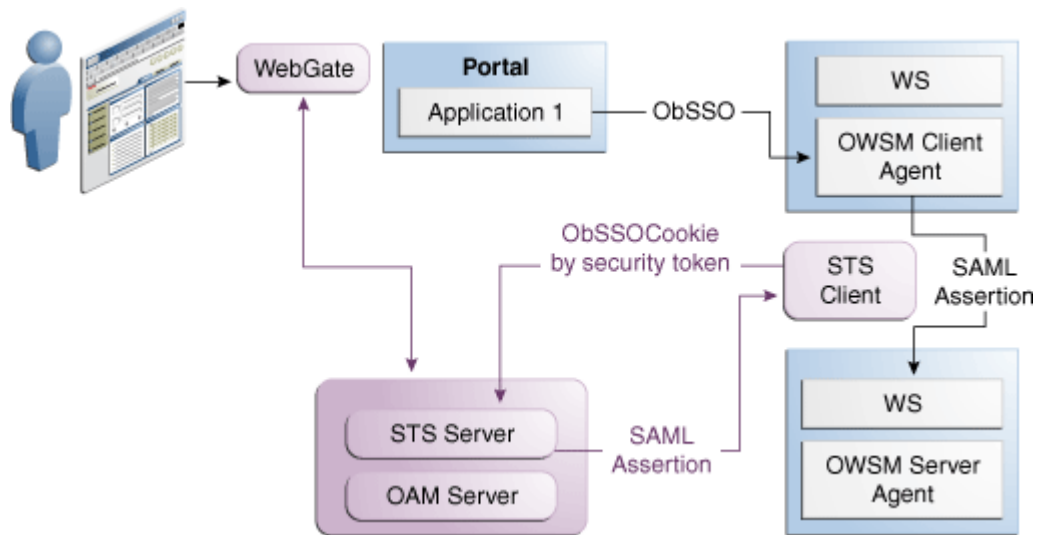
**Figure 41-3 Token Translation at a Centralized Authority**

### 41.7.2 About Tokens Behind a Firewall Deployment

The Security Token Service provides the administrator with a control over the token translation process by performing it behind the firewall.

The situation when applications rely on special form of credentials for their business logic is common in deployments of Oracle access products. Integrations of WAC systems with both Oracle and custom applications almost always require extensive coding for:

1. Decomposing tokens issued by one token authority (such as OAM or SiteMinder) by calling a proprietary vendor API (SM agent API or ASDK).
2. Composing a new token format (PSFT, Siebel), that the application requires for its internal business logic.

Although such translations are often handled through application coding, it introduces the risk of exposing user names and passwords when the code is deployed on multiple application instances in the DMZ. Thus, Security Administrators need an ability to control the translation process by externalizing it from the application. Introducing the Security Token Service provides significant relief in this situation.

Figure 41-4 shows the Security Token Service plays the role of a centralized token authority by performing token translation behind the firewall.

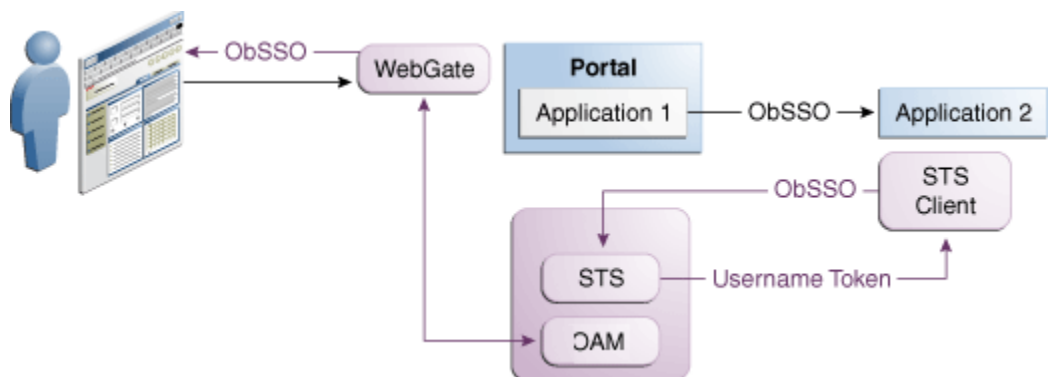
**Figure 41-4 Translating Tokens Behind a Firewall**

Application 1 and Application 2 are protected by Access Manager. Application 2 relies on a different type of token for its internal business logic. It has a client-side connector that contacts Security Token Service for exchanging the OBSSO token for a username token. The Security Token Service relies on Access Manager for decomposing the OBSSO token and generates the new token required by Application 2. This is more secure, because the same authority (Access Manager) performs both operations (composing and decomposing the OBSSO token) thus, there is no need to decompose the token on the application side.

### 41.7.3 About Web Services SSO Deployment

As in the Web SSO case, Web services SSO is a convenience feature. The difference is that in the case of Web SSO the party who benefits from the feature is a user; in the WS SSO environment, the Security Administrator benefits.

With Web services SSO different Web services have different token requirements (that change often). Externalizing the exchange to Security Token Service enables the application to simply supply the target and the current token in its possession. Security Token Service takes charge of determining the token type for each requested service. When one or more Web services change their authentication requirements, Security Token Service can seamlessly verify the token type submitted by the application. If the token is not of the requested type, the old token is revoked and the new one of the correct type is issued.

Figure 41-5 illustrates Web services SSO.

Figure 41-5 Web Services SSO

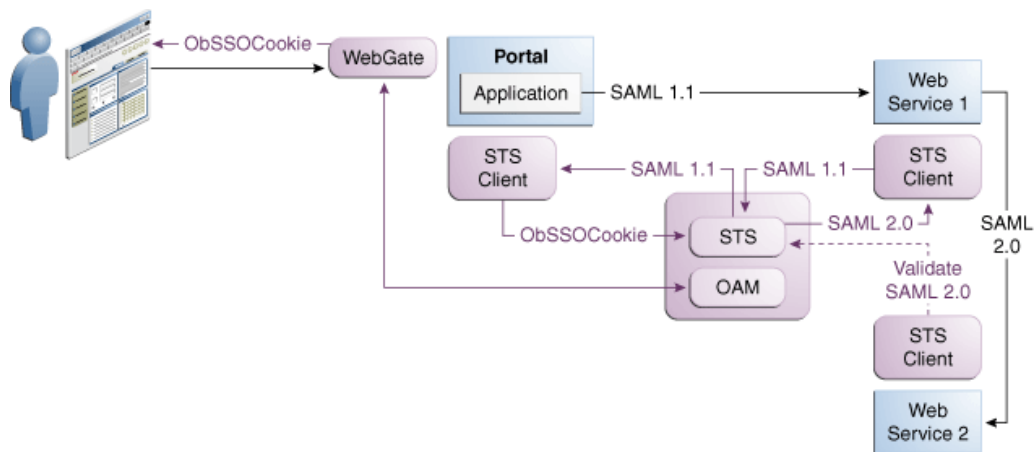

## 41.8 About the Installation of the Security Token Service

The following topics describe the installation options for the Security Token Service:

- [About Security Token Service Cluster in Single WLS Domain](#)
- [About Endpoint Exposure through a Web Server Proxy](#)
- [About Security Token Service Installation Overview](#)
- [Post-Installation Tasks: Security Token Service](#)

### 41.8.1 About Security Token Service Cluster in Single WLS Domain

This installation option for Security Token Service leverages clustering across Security Token Service instances within a single WebLogic domain. This deployment topology facilitates High Availability capabilities through a load balancer. By default, Access Manager co-exists on the same managed server as Security Token Service. However, Security Token Service is disabled by default and must be manually enabled before it can be used.

This deployment topology supports:

- Deploying multiple instances of Security Token Service through the suite installer.
- Deploying a load balancer to support the High Availability and failover scenarios on the front of the Security Token Service cluster.

See Server Load Balancing in a High Availability Environment in *High Availability Guide*.

### 41.8.2 About Endpoint Exposure through a Web Server Proxy

This installation option for Security Token Service provides inter-operability of Requester and Relying Party with Third-party STS Servers. At runtime, Security Token Service supports interoperability with Requesters and Relying Parties of third-party security token servers using the OPSS WS-Trust-Provider.

For instance, a third-party Security Token Service can create a valid SAML Assertion that can be consumed by Security Token Service.

### 41.8.3 About Interoperability of Requester and Relying Party with Other Oracle WS-Trust based Clients

All run-time scenarios for Requesters and Relying Parties are supported by other Oracle WS-Trust Clients.

The WS-Trust Clients includes WLSClient, MetroClient, and Oracle Web Services Manager (Oracle WSM). All Web services clients are supported with Security Token Service only through the WS-Trust binding.

### 41.8.4 About Security Token Service Installation Overview

Access Manager and Security Token Service are installed together from a single EAR file and deployed on the same managed server in a WebLogic domain.

The Oracle WSM Agent uses a keystore for various cryptographic operations. For those tasks, the Oracle WSM Agent uses the keystore configured for Oracle WSM tasks. During installation, if the Oracle WSM keystore service has not been configured, the installer:

- Creates a new keystore in the `$DOMAIN_HOME/config/fmwconfig` folder (default name is `default-keystore.jks`)
- Creates a key entry with the corresponding certificate to be used by OWSM for signature and encryption operations. This key entry is stored in the OWSM Keystore under the `orakey` alias
- Stores the passwords of the key entry and of the keystore in CSF

Having access to the keystore is sometimes required to:

- Extract the signing or encryption certificate to distribute to clients, if needed

- Update or replace the signing or encryption key entry
- Add trusted certificates

For more information, see the *Oracle Fusion Middleware Installation Guide for Oracle Identity and Access Management*.

### 41.8.5 Post-Installation Tasks: Security Token Service

Any server hosting Security Token Service must be registered with Access Manager. This can occur automatically during installation, or manually after installation.

All Security Token Service system configuration is done using the Oracle Access Management Console. Elements in the Oracle Access Management Console enable Administrators to easily configure the Security Token Service to exchange WS Trust tokens with partners. Other Security Token Service elements provide for creation, viewing, modification, and removal of partners, endpoints, validation templates, issuance templates, and data store connections.

See [Managing Oracle Access Management Security Token Service](#) for details about the Security Token Service.

## 41.9 Administrating the Security Token Service

A single LDAP group, the WebLogic Server "Administrators" group, is set by default.

During initial deployment, using the Oracle Fusion Middleware Configuration Wizard, the Administrator userID and password are set. Administrators can log in and use the Oracle Access Management Console (and WebLogic Server Administration Console).

See [Starting and Stopping Servers in Your Deployment](#).

## Security Token Service Implementation Scenarios

Several Security Token Service implementation for processing a number of scenarios. Different scenarios share many configuration tasks as well as token handling.

The following topics provide information about Security Token Service implementation scenarios:

- [Typical Token Ecosystem](#)
- [Scenario: Identity Propagation with the Access Manager Token](#)
- [Scenario: Web Service Security On Behalf Of Username Token](#)

### 42.1 Typical Token Ecosystem

A typical environment where security tokens, based on the security model required, are used to serve an end goal is known as typical security token ecosystem.

The abstract model has been chosen because the requirements placed on Security Token Service must support such models. The phrase security token ecosystem is used to represent a typical environment where security tokens are in use. In such environments the security token, based on the security model required for the environment, could be used to serve an end goal such as to enable brokered trust or single-sign-on and so on. Regardless of the environment and the type of security token, several aspects are common across all models, as shown and described here.

[Figure 42-1](#) illustrates a typical token ecosystem, which includes: Token Issuing Authority, Token Requestor, Token Consumer, and the Security Token.

**Figure 42-1** *Typical Token Ecosystem*

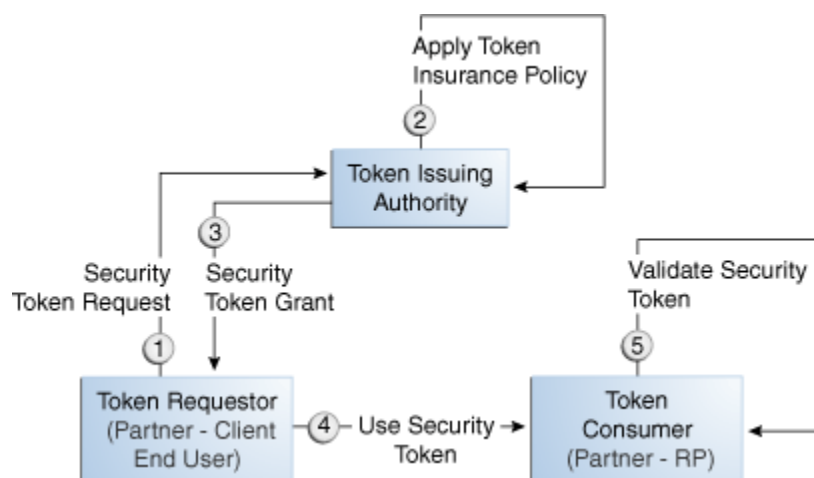

### 42.1.1 Actors and Process Overview: In a typical token ecosystem

The following process describes a typical environment where security tokens are in use:

1. The Token Requestor places a request for a security token at the Token Issuing Authority.  
  
This security token is required to communicate and request access to a service provided by a Service Provider (a Token Consumer who accepts the security token).
  - A Token Requestor could be a Partner of the Token Issuing Authority (generally registered with the Token Issuing Authority).
  - A Token Requestor could be an End User (generally not registered with the Token Issuing Authority).
2. The Token Issuing Authority (Access Manager and Security Token Service, for example) receives and processes the security token request and returns a security token, as follows:
  - Authenticate the input credentials.
  - Authorize the security token request based on a Token Issuance Policy that specifies which Token Requestors are authorized to request a security token for a given Token Consumer.
3. The Token Consumer (typically a service provider).
  - Accepts the security token as part of the service request and provides service based on the validity of the input security token.
  - Validates the input security token with Token Issuing Authority.

---

---

**Note:**

A Token Consumer is typically a registered Partner of the Token Issuing Authority. A Token Consumer is also known as a Relying Party, because it trusts and relies on the Token Issuing Authority for Token Requestor authentication. Token Consumers (Relying Party Partner) are Web Applications (for Access Manager, Security Token Service is the Token Issuing Authority) or STS Relying Party Web Services.

---

---

## 42.2 Scenario: Identity Propagation with the Access Manager Token

While supporting security tier-specific or domain-specific security requirements, the user's Identity information becomes visible and gets propagated across different tiers or domains. To achieve Identity propagation using Security Token Service with Access Manager, brokered-trust model can be used.

This is a deployment where the user's Identity information needs to be propagated from a Web application to a Web service provider. The Web service provider can reside in the same security domain as the web application or in a different security domain.

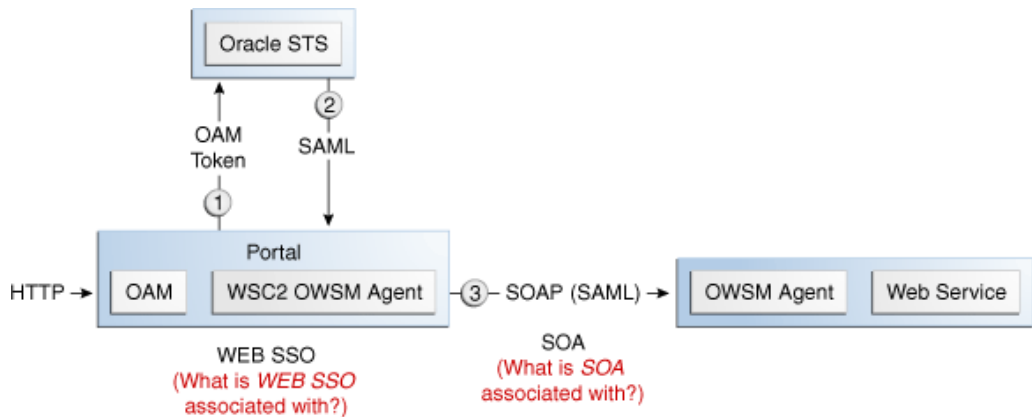
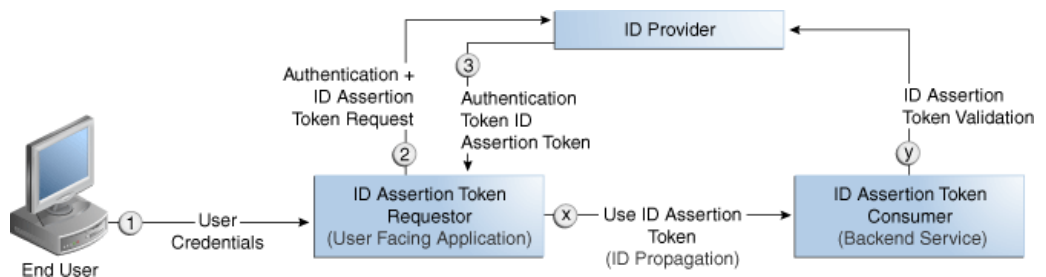

**Figure 42-2 Identity Propagation with the OAM Token**

Identity propagation means that the original user context becomes visible outside its original security tier or domain boundaries. The user security context is propagated across different security tiers or domains to support tier-specific or domain-specific security needs such as step-up authentication, authorization, audit and/or internal application-specific business logic.

ID Propagation is said to occur in a distributed processing of a request when the identity context established in the first node is propagated to subsequent nodes to enable further processing of the request in the context of that identity. ID Propagation can be achieved in several ways. One of them is based on a brokered-trust model where an ID provider acts as a trust-broker for ID Assertions. The discussion here is pertains to this model.

Figure 42-3 illustrates an ID Propagation scenario in a brokered-trust model, where a user-facing application needs to request processing by a backend service application in the context of the end user. To bring out the main aspects of ID propagation all other interaction and relationship details between end user, application, and backend service application are ignored.

**Figure 42-3 Process Flow During Identity Propagation**

### 42.2.1 Actors and Process Overview: Identity Propagation

In a typical process that deals with identity propagation, ID Assertion Token Requestor, ID Provider, and ID Assertion Token Consumer are involved.

The following overview enables you to familiarize with any actors and processes that deal with identity propagation:

1. The ID Assertion Token Requestor (an End User-Facing Application), upon end user access, requests authentication and ID Assertion Token at the identity Provider.

**Note:**

Examples of ID Assertion Token Requestors include Web applications that are protected by OAM. The ID Assertion Token request could be either implicit or could be driven by a policy at the ID Provider.

2. The ID Provider (Security Token Service) processes the request and returns an Authentication Token and an ID Assertion Token. An ID Assertion Token, in itself, does not represent a user session and cannot be used independently to request direct access to a resource or service.
3. The ID Assertion Token Requestor uses this Token later, during the end user session, as part of a backend service processing request (on behalf of the end user).
4. The ID Assertion Token Consumer (Security Token Service), as part of the request processing, first validates the ID Assertion Token and then (on validation success) processes the request in the context of the end user Identity

See [About Component Processing: Identity Propagation with the OAM Token](#).

See [Request Security Token Attributes and Run Time Processing](#).

See [Configuration Requirements: Identity Propagation with the OAM Token](#).

### 42.2.2 About Component Processing: Identity Propagation with the OAM Token

Identity propagation can be deployed and processed using Security Token Service with Access Manager.

[Figure 42-4](#) illustrates a typical deployment topology for Identity propagation using Security Token Service with Access Manager.

**Figure 42-4 Identity Propagation Deployment**

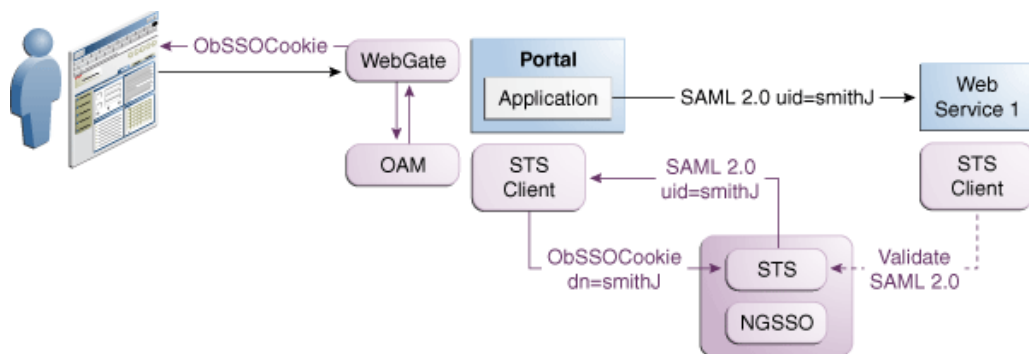

[Figure 42-5](#) illustrates a processing of Identity propagation using Security Token Service with Access Manager. Details follow the figure.

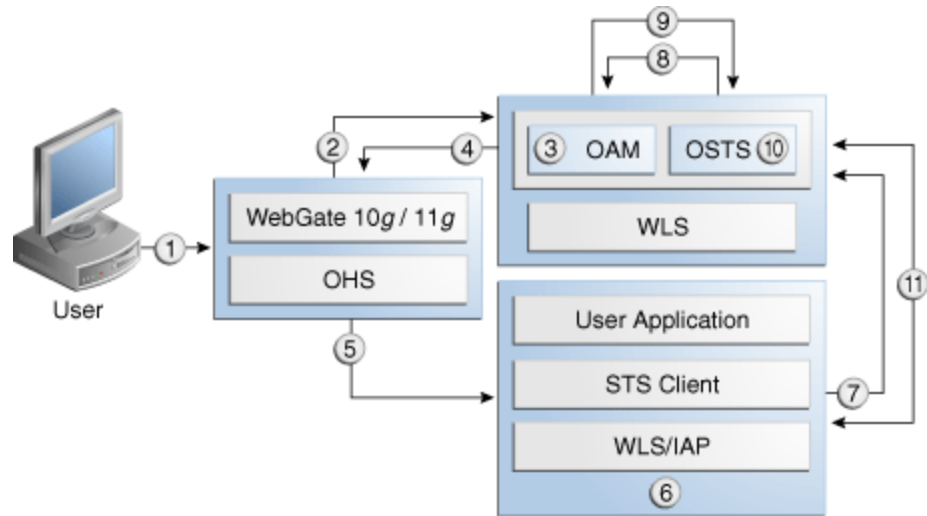
**Figure 42-5 Identity Propagation Processing**

#### 42.2.2.1 Process overview: Component interactions for Identity Propagation

In the process of identity propagation, when a user tries to access a protected resource, interactions between the components are established. The components include WebGate, Access Manager, WebLogic Server, Access Manager Identity Asserter on WebLogic Server, Web Service Client, and Security Token Service.

The following steps provide an overview on components interacts for Identity Propagation:

1. User attempts to access a protected resource.
2. WebGate is protecting the resource; it sends request to Access Manager for authentication and authorization.
3. Access Manager authenticates the user using the policy configured for this WebGate Application Domain. It sees the response type "IDENTITY\_ASSERTION" is configured for this Webgate, so it generates ID Assertion token as well.
4. Access Manager sends authentication and ID assertion token to WebGate
5. WebGate processes the response; sets ID assertion token to the header; (OHS where WebGate is installed on) then redirect the request to the WLS that hosts the resource.
6. IAP (Access Manager Identity Asserter on WebLogic Server) sees OAM\_IDENTITY\_ASSERTION header is set, processes the headers, then sets ID assertion token to Subject's private credential as `OamIdentity`.
7. When the resource is finally accessed, a Web Service Client can then obtain the ID assertion token from current user's Subject, generates a OnBehalfOf (OBO) token with it, then creates and sends Request Security Token (RST) to Security Token Service.
8. Security Token Service sees the ID assertion Token inside OBO token, it sends validation/authentication request to Access Manager using Access Manager library.

9. Access Manager validates and authenticates the ID Assertion Token, then sends response (user identity) to Security Token Service.
10. Security Token Service uses this user identity to do further processing: policy evaluation, token issuance, and so on. It then generates Request Security Token Response.
11. Security Token Service sends Request Security Token Response to the client, which can then use the token inside the Request Security Token Response (RSTR) to create a web service request to access a service hosted on a relying party.

### 42.2.3 Request Security Token Attributes and Run Time Processing

You need to configure the Security Token Service to process a request and issue a token for an incoming Request Security Token (RST) with the following attributes:

- [RST Attributes for Identity Propagation with the OAM Token](#)
- [Process overview: Identity Propagation with the OAM Token](#)

#### 42.2.3.1 RST Attributes for Identity Propagation with the OAM Token

You can apply RST attributes for ID propagation using Security Token Service with Access Manager.

Following are the attributes for ID propagation:

- The SOAP header contains a Username token referencing a WS Requester. The Username token contains at least a username and a password.
- The SOAP body contains a WS-Trust RST message
- The RST contains a OAM ID Propagation token in the OnBehalfOf field referencing a user in LDAP. The token included in the OnBehalfOf element is a BinarySecurityToken, whose text value is the Base 64 encoded format of the OAM Session Propagation Token, and whose ValueType attribute is `http://something.example.com/am/2012/11/token/session-propagation` and whose EncodingType attribute is `http://docs.oasis-open.org/wss/2004/01/oasis-200401-wss-soapmessage-security-1.0#Base64Binary`
- The RST can possibly contain an AppliesTo field holding a URL pointing to the endpoint of the Relying Party Web Service
- The RST can possibly contain a TokenType field holding the type of token that needs to be returned
- The RST can possibly contain an Entropy field holding random data that will be used when creating the SecretKey when a symmetric proof key is required in the SAML Assertion
- The RST can possibly contain a UseKey field holding the certificate or public key to be used as an asymmetric proof key in the SAML Assertion, but this field will be ignored by Security Token Service

### 42.2.3.2 Process overview: Identity Propagation with the OAM Token

The client prepares and sends the request to the Security Token Service. Before creating a response to the client, the Security Token Service validates the token and creates one if required.

The following steps explain how to apply Identity Propagation with the OAM token:

1. Client prepares the request by:
  - a. Creating the SOAP message
  - b. Creating the Username token referencing the client and including it in the SOAP header
  - c. Creating the WS-Trust RST message
  - d. Creating the OAM ID Propagation token referencing the user and including it in the OnBehalfOf field of the RST
  - e. Including the RST message in the SOAP body
2. Client sends the message to the Security Token Service, to an endpoint protected by a WS-Security User Name Token (UNT) Policy, with that endpoint being mapped to an Security Token Service WSS Validation Template.
3. Security Token Service will process the incoming request
4. Security Token Service validates the token included in the SOAP header by using the settings contained in the WS-Security Validation Template:
  - a. Validates the format of the Username token
  - b. Validates the credentials contained in the Username token against the Security Token Service Partner store, thus mapping this token to a Requester Partner
  - c. Knowing the Requester Partner, Security Token Service will retrieve the Requester Partner Profile associated with this Requester
5. Security Token Service then validates the token present in the OnBehalfOf field:
  - a. Determines the type of token present in the OnBehalfOf field
  - b. Retrieves the WS-Trust Validation Template to be used for OAM Token Type, from the Requester Partner Profile
  - c. Validates the format of the OAM token Validates the OAM token, and maps the token to a user
  - d. Creating the OAM ID Propagation token referencing the user and including it in the OnBehalfOf field of the RST
6. Security Token Service then examines the AppliesTo field:
  - If present, Security Token Service will attempt to map the AppliesTo URL to a Relying Party Partner, using the WS Endpoint Mapping of the Relying Party Partner. If the mapping is successful, then the AppliesTo field has been mapped to a Relying Party Partner, and Security Token Service will retrieve the Relying Party Partner Profile from this Partner. If mapping was not

successful, then the AppliesTo field could not be mapped to a Relying Party Partner, and Security Token Service will retrieve the Default Relying Party Partner Profile from the Requester Partner Profile.

- If absent, Security Token Service will retrieve the Default Relying Party Partner Profile from the Requester Partner Profile.
7. Security Token Service then examines the TokenType field:
    - If present, Security Token Service will map the TokenType string to a local token type value using the Requester Partner Profile, and it will then use the Relying Party Partner Profile to retrieve the Issuance Template to be used to create the outgoing token.
    - If absent, Security Token Service will retrieve the default token type from the Relying Party Partner Profile, and it will then use the Relying Party Partner Profile to retrieve the Issuance Template to be used to create the outgoing token.
  8. Security Token Service will perform an Authorization evaluation to check that the Requester Partner is authorized to request a token for the Relying Party referenced in the flow (see Authorization Trust Policy for more information)
  9. Security Token Service will then create the token:
    - If the token to be issued is of SAML type, then the Issuance Template will list how to populate the NameID, the Relying Party Partner Profile will list which attributes need to be sent in the token, the Issuance Template will indicate whether or not to translate the names and values of the attributes, the Issuance Template will indicate whether or not to sign/encrypt the token.
    - If the token to be issued is of SAML type, the Security Token Service server will examine the KeyType to determine the Subject Confirmation Method of the Assertion. If it is missing, it will use the Default Confirmation Method from the Issuance Template.
  10. Security Token Service will create the Response that the client will process:
    - a. Creates the WS-Trust RSTRC
    - b. Includes the returned token
    - c. Includes proof key if necessary

#### 42.2.4 Configuration Requirements: Identity Propagation with the OAM Token

The following topics list the configuration requirements for the identity propagation scenario:

- [Configuration Overview: Identity Propagation with the OAM Token](#)
- [WebLogic Server Identity Assertion Providers](#)
- [Access Manager Identity Asserter Details](#)
- [LDAP Authentication Provider Details](#)
- [Default Identity Store Configuration](#)

- [Token Issuance Policy](#)
- [Authentication Policy Response for Identity Assertion by Webgate](#)
- [Endpoint Configuration](#)
- [Issuance Template Configuration](#)
- [Partner Configuration: Requester](#)
- [Partner Profile: Relying Party](#)
- [Partner Profile: Requester](#)
- [Validation Template for WS-TRUST](#)
- [Cookies and Headers \(Truncated\)](#)
- [Request Security Token Sent By the Client \(Truncated\)](#)
- [Request Security Token Sent By the Client \(Truncated\)](#)

#### 42.2.4.1 Configuration Overview: Identity Propagation with the OAM Token

You can configure the Identity Propagation environment using Security Token Service with Access Manager.

Following is an overview of the Identity Propagation environment and implementation tasks:

- A custom application module that will act as a client to:
  - Retrieve the OAM Session Propagation token from the HTTP request
  - Send a WS-Trust request to the Security Token Service server with Access Manager Session Propagation token as the OnBehalfOf element
- A web application that will be protected by Webgate and will invoke the client web application that will send a WS-Trust request to Security Token Service
- Security Token Service URL: `http://myhost.domain.com:14100/sts/<endpoint>`

---

---

**Note:**

Replace `<endpoint>` with the path configured in the STS Endpoints section.

---

---

- An OHS 11g with Webgate protecting the web application  
Provision (register) a Webgate (11g or 10g) to protect the application deployed in WebLogic Server.  
The `OAMSuite` Application Domain is pre-seeded and delivered with Access Manager 11g. When you provision an OAM Agent to use this (or another existing) Application Domain, decline the option of having policies automatically created.  
Reverse Proxy mapping for Webgate in the OHS Server `mod_wl_ohs.conf`, is shown here.

```
<IfModule weblogic_module>
 WebLogicHost yourhost.domain.com
 WebLogicPort 7001
 Debug ON
 WLLogFile /tmp/weblogic.log
 MatchExpression /stsclient/*.jsp
</IfModule>
```

The following Security Token Service configuration is required to implement token processing for identity propagation:

- One Requester Partner Profile
- One Relying Party Partner Profile
- One Issuance Template
- One WS-Trust Validation Template
- Security Token Service Endpoint
- An LDAP server is required for Security Token Service to map the Username token referencing the user to an LDAP User record, and thus use that record to populate the outgoing token.

Ensure that the desired LDAP server is configured as the Default Identity Store.

#### 42.2.4.2 WebLogic Server Identity Assertion Providers

Deploy the Identity Assertion Providers war. The Access Manager Identity Asserter is available in the following path with Oracle Fusion Middleware installed:

\$ORACLE\_HOME/modules/oracle.oamprovider\_11.1.1/oamauthenticationprovider.war

Copy oamauthenticationprovider.war to the following location:

\$BEA\_HOME/wlserver\_10.x/server/lib/console-ext/autodeploy/oamauthenticationprovider.war

**Figure 42-6 Required v1.0 WebLogic Server Identity Assertion Providers**

<input type="checkbox"/>	Name	Description	Version
<input type="checkbox"/>	IAP-OSTS	Oracle Access Manager Identity Asserter	1.0
<input type="checkbox"/>	IAP-DSEE	Provider that performs LDAP authentication	1.0
<input type="checkbox"/>	DefaultAuthenticator	WebLogic Authentication Provider	1.0
<input type="checkbox"/>	DefaultIdentityAsserter	WebLogic Identity Assertion provider	1.0

Figure 42-6 illustrates the required WebLogic Server Identity Assertion Providers configuration for this scenario.

#### 42.2.4.3 Access Manager Identity Asserter Details

You can use the REQUIRED Control flag to set the Identity Asserter.

The IAP-Security Token Service identity asserter must be the first, and set using the REQUIRED Control flag. The Active Types should be set as ObSSOCookie and OAM\_REMOTE\_USER, with an SSO Header name of OAM\_REMOTE\_USER1.

Figure 42-7 illustrates the configuration.



**Figure 42-7 IAP-Security Token Service Details**

<b>Name:</b>	IAP-OSTS				
<b>Description:</b>	Oracle Access Manager Identity Asserter				
<b>Version:</b>	1.0				
<b>Control Flag:</b>	REQUIRED				
<b>Active Types:</b>	<table border="1"> <tr> <td><b>Available:</b></td> <td><b>Chosen:</b></td> </tr> <tr> <td></td> <td> <input type="checkbox"/> ObSSOCookie  <input checked="" type="checkbox"/> OAM_REMOTE_USER         </td> </tr> </table>	<b>Available:</b>	<b>Chosen:</b>		<input type="checkbox"/> ObSSOCookie <input checked="" type="checkbox"/> OAM_REMOTE_USER
<b>Available:</b>	<b>Chosen:</b>				
	<input type="checkbox"/> ObSSOCookie <input checked="" type="checkbox"/> OAM_REMOTE_USER				
<b>Base64 Decoding Required:</b>	false				

Save

Settings for IAP-OSTS

**Configuration**

Common **Provider Specific**

Save

This page allows you to configure additional attributes for this security provider.

<b>Transport Security:</b>	open
<b>Minimum Access Server Connections In Pool:</b>	5
<b>Application Domain:</b>	
<b>Access Gate Password:</b>	
<b>Please type again To confirm:</b>	
<b>Key Store Pass Phrase:</b>	
<b>SSOHeader Name:</b>	OAM_REMOTE_USER1

#### 42.2.4.4 LDAP Authentication Provider Details

You need to create the Authenticator for the LDAP with the OPTIONAL JAAS flag.

This flag points to the Default System Store of Oracle Access Management which provides the Access Manager token.

Figure 42-8 illustrates this process.

**Figure 42-8 LDAP Provider: IAP-DSEE**

Settings for IAP-DSEE

Configuration Performance

Common Provider Specific

This page displays basic information about this iPlanet Authentication provider. You can also use this page to set the JAAS Control Flag to control how this provider is used in the login sequence.

**Name:** IAP-DSEE The name of this iPlanet Authentication provider. [More Info...](#)

**Description:** Provider that performs LDAP authentication A short description of this iPlanet Authentication provider. [More Info...](#)

**Version:** 1.0 The version number of this iPlanet Authentication provider. [More Info...](#)

**Control Flag:**  Specifies how this iPlanet Authentication provider fits into the login sequence. [More Info...](#)

**Connection**

**Host:**  The host name or IP address of the LDAP server. [More Info...](#)

**Port:**  The port number on which the LDAP server is listening. [More Info...](#)

**Principal:**  The Distinguished Name (DN) of the LDAP user that WebLogic Server should connect to the LDAP server. [More Info...](#)

**Credential:**  The credential (usually a password) used to connect to the LDAP server. [Info...](#)

**Confirm Credential:**

**SSL Enabled** Specifies whether the SSL protocol should be used when connecting to the server. [More Info...](#)

**Users**

**User Base DN:**  The base distinguished name (DN) of the tree in the LDAP directory that contains users. [More Info...](#)

**All Users Filter:**  If the attribute (user object class) is not specified (that is, if the attribute is null or empty), a default search filter is created based on the user schema. [More Info...](#)

**User From Name Filter:**  If the attribute (user name attribute and user object class) is not specified is, if the attribute is null or empty), a default search filter is created based on user schema. [More Info...](#)

**User Search Scope:**  Specifies how deep in the LDAP directory tree the LDAP Authentication provider should search for users. [More Info...](#)

**User Name Attribute:**  The attribute of an LDAP user object that specifies the name of the user. [Info...](#)

### 42.2.4.5 Default Identity Store Configuration

**Figure 42-9 Default Identity Store Defined in Access Manager**

Welcome dsee7

dsee7

Default Store Test Connection Apply

Store Name: dsee7

Description:

\* Store Type:

Enable SSL

**Location and Credentials**

\* Location:

\* Bind DN:

\* Password:

**Default and System Store Options**

This is the Default Store

Set as system store (Current System Store: UserIdentityStore1)

**Users and Groups**

\* User Name Attribute:

\* User Search Base:

User Filter Object Classes:

Group Name Attribute:

\* Group Search Base:

Group Filter Classes:

Figure 42-9 illustrates the Default Identity Store configuration within Oracle Access Management Console.

#### 42.2.4.6 Token Issuance Policy

You need to create the Token Issuance Policy for the resource URL within the IAM Suite Application Domain.

Figure 42-10 shows the Token Issuance Policy page.

**Figure 42-10 Token Issuance Policy for Identity Propagation**

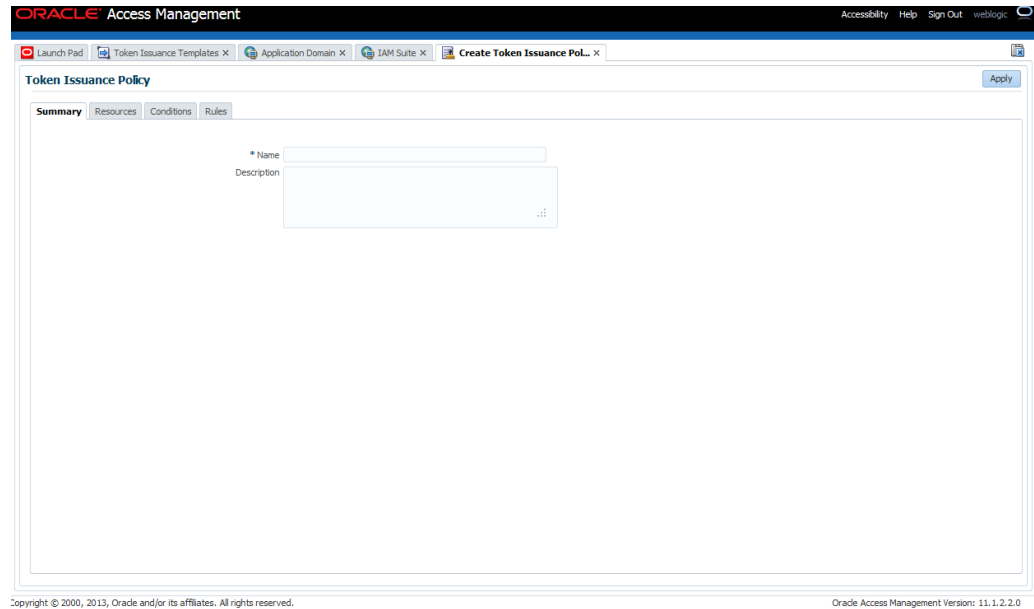

#### 42.2.4.7 Authentication Policy Response for Identity Assertion by Webgate

When an authentication is successful, the WebGate returns an Identity Assertion Token as a policy response.

Identity Assertion is required for ID propagation for any issued token from Access Manager that represents an end user (and possibly its OAM session). The Identity Assertion Token is generated and returned as a policy response (HTTP HEADER named "OAM\_IDENTITY\_ASSERTION" with a value as a SAML token) after a successful authentication.

The ID Provider (Access Manager) processes the request and returns an Authentication Token and an ID Assertion Token. An ID Assertion Token, in itself, does not represent a user session and cannot be used independently to request direct access to a resource or service.

Security Token Service clients that are Web applications protected by Access Manager requesting tokens to gain proxy access to a Relying Party (ID Propagation use case) are required to pass an OAM Identity Assertion token that represents the end user.

The ID Assertion Token Requestor uses this Token later, during the end user session, as part of a backend service processing request (on behalf of the end user).

The ID Assertion Token Consumer (Security Token Service), as part of request processing, first validates the ID Assertion Token and then (on validation success) processes the request in the context of the end user Identity.

See [Introduction to Policy Responses for SSO](#).

Confirm that the Identity Assertion box is checked as part of the Authentication Policy Response within the IAM Suite Application Domain. This enables Webgate to perform Identity Assertion for protected resources.

See [Adding and Managing Policy Responses for SSO](#).

As you add each Response, you might be informed that Identity Assertion has not been enabled for this policy. Enable Identity Assertion in order to collect Assertion Attribute type responses (when this policy is executed).

#### 42.2.4.8 Endpoint Configuration

The /wss10 user Endpoint is required.

This is the one that you can use in the Web application to post the RST.

[Figure 42-11](#) shows the /wss10user Endpoint. The endpoint is protected by the default WS-Security Validation Template that is used in the Web application to post the RST.

**Figure 42-11 /wssuser Endpoint for Identity Assertion**

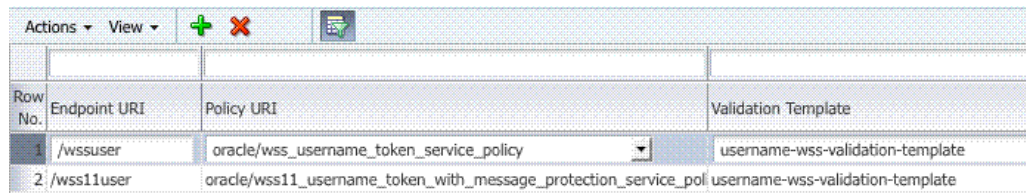

Row No.	Endpoint URI	Policy URI	Validation Template
1	/wssuser	oracle/wss_username_token_service_policy	username-wss-validation-template
2	/wss11user	oracle/wss11_username_token_with_message_protection_service_pol	username-wss-validation-template

#### 42.2.4.9 Issuance Template Configuration

The Issuance Template requires configuration parameters such as **Token Type** and **Signing Key Id** for Identity Propagation.

The Issuance Template requires the following configuration for :

- Name: iap-issuance-template
- Description: Custom issuance template
- Token Type: SAML 2.0
- Signing Key Id: osts\_signing
- Description: Custom issuance template

#### 42.2.4.10 Partner Configuration: Requester

Create a new Requester Partner configuration for Identity Propagation with the OAM token as follows:

- Partner Name: iap-request-partner
- Requester Type: STS\_REQUESTER
- Partner Profile: iap-requestor-profile
- Description: Custom requester
- Trusted
- Username Token Authentication

- *Username* <enter username used by the Web Service Client>
- *Password* <enter password used by the Web Service Client>
- Confirm *Password* <enter password used by the Web Service Client>
- Identity Attribute values for:
  - httpbasicusername
  - sslclientcertdn

#### 42.2.4.11 Partner Profile: Relying Party

You can create a new Relying Party Profile for Identity Propagation.

To create a new Relying Party Partner Profile:

- Profile ID: iap-relyingparty-profile
- Description: iap-issuance-template
- Default Token Type: SAML 2.0
- Default Template: iap-issuance-template

#### 42.2.4.12 Partner Profile: Requester

You can create new Requester Profile for Identity Propagation.

To create a new Requester Partner Profile:

- Profile ID: iap-requestor-profile
- Description: iap-requestor-profile partner profile
- Default Relying Party Profile: iap-relyingparty-profile

#### 42.2.4.13 Validation Template for WS-TRUST

The Validation Template for WS-TRUST requires configuration parameters such as **Token Protocol** and **Token Type** for Identity Propagation.

The required configuration parameters are the following:

- Validation Template Name: iap\_wstrust\_validation\_template
- Description: iap\_wstrust\_validation\_template
- Token Protocol: WS-Trust
- Token Type: OAM
- Timestamp Lifespan:

This completes the configuration requirements for the Identity Propagation with OAM Token scenario.

### 42.2.5 Testing Your Implementation

You can access the resource to confirm that your implementation is working properly.



1. User attempts to access a protected resource.
2. User is authenticated.
3. The WebLogic container sets the user's identity into a Subject for this session.
4. When the resource is finally accessed, a Web Service Client can then obtain the user's identity from current user's Subject, generates a OnBehalfOf (OBO) token with it, then creates and sends Request Security Token (RST) to Security Token Service.
5. Security Token Service authenticates the Web Service Client as a Requester Partner.
6. Security Token Service sees the Username Token inside OBO token, it maps the user's identity to a user record in LDAP.
7. Security Token Service then generates Request Security Token Response.
8. Security Token Service sends Request Security Token Response to the client, which can then use the token inside the Request Security Token Response (RSTR) to create a web service request to access a service hosted on a relying party.

### 42.3.2 RST Attributes and Processing for Identity Propagation with a Username Token

For an incoming Request Security Token (RST), Oracle Security Token Service must be configured to process a request and issue a token.

The following topics provide information about RST attributes and processing for Identity propagation with a username token:

- [RST Attributes for Identity Propagation with a Username Token](#)
- [Process overview: Identity Propagation with the OAM Token](#)

#### 42.3.2.1 RST Attributes for Identity Propagation with a Username Token

You can apply RST attributes for ID propagation using a Username Token.

- The SOAP header contains a Username token referencing a WS Requester. The Username token contains at least a username and a password.
- The SOAP body contains a WS-Trust RST message.
- The RST contains a Username Token in the OnBehalfOf field referencing a user in LDAP.
- The RST can possibly contain an AppliesTo field holding a URL pointing to the endpoint of the Relying Party Web Service.
- The RST can possibly contain a TokenType field holding the type of token that needs to be returned.
- The RST can possibly contain an Entropy field holding random data that will be used when creating the SecretKey when a symmetric proof key is required in the SAML Assertion.
- The RST can possibly contain a UseKey field holding the certificate or public key to be used as an asymmetric proof key in the SAML Assertion, but this field will be ignored by Security Token Service.

### 42.3.2.2 Process overview: Identity Propagation with the OAM Token

The client prepares and sends the request to the Security Token Service. Before creating a response to the client, the Security Token Service validates the token and creates one if required.

1. Client prepares the request by:
  - Creating the SOAP message
  - Creating the Username token referencing the client and including it in the SOAP header.
  - Creating the WS-Trust RST message.
  - Creating the Username Token referencing the user and including it in the OnBehalfOf field of the RST.
  - Including the RST message in the SOAP body.
2. Client sends the message to the Security Token Service, to an endpoint protected by a WS-Security User Name Token (UNT) Policy, with that endpoint being mapped to an Security Token Service WSS Validation Template.
3. Security Token Service will process the incoming request.
4. Security Token Service validates the token included in the SOAP header by using the settings contained in the WS-Security Validation Template:
  - Validates the format of the Username token.
  - Validates the credentials contained in the Username token against the Security Token Service Partner store, thus mapping this token to a Requester Partner.
  - Knowing the Requester Partner, Security Token Service will retrieve the Requester Partner Profile associated with this Requester.
5. Security Token Service then validates the token present in the OnBehalfOf field:
  - Determines the type of token present in the OnBehalfOf field.
  - Retrieves the WS-Trust Validation Template to be used for Username Token Type, from the Requester Partner Profile.
  - Validates the Username Token, and maps the token to a user.
6. Security Token Service then examines the AppliesTo field:
  - If present, Security Token Service will attempt to map the AppliesTo URL to a Relying Party Partner, using the WS Endpoint Mapping of the Relying Party Partner. If the mapping is successful, then the AppliesTo field has been mapped to a Relying Party Partner, and Security Token Service will retrieve the Relying Party Partner Profile from this Partner. If mapping was not successful, then the AppliesTo field could not be mapped to a Relying Party Partner, and Security Token Service will retrieve the Default Relying Party Partner Profile from the Requester Partner Profile.



- If absent, Security Token Service will retrieve the Default Relying Party Partner Profile from the Requester Partner Profile.
7. Security Token Service then examines the TokenType field:
    - If present, Security Token Service will map the TokenType string to a local token type value using the Requester Partner Profile, and it will then use the Relying Party Partner Profile to retrieve the Issuance Template to be used to create the outgoing token.
    - If absent, Security Token Service will retrieve the default token type from the Relying Party Partner Profile, and it will then use the Relying Party Partner Profile to retrieve the Issuance Template to be used to create the outgoing token.
  8. Security Token Service will perform an Authorization evaluation to check that the Requester Partner is authorized to request a token for the Relying Party referenced in the flow (see Authorization Trust Policy for more information).
  9. Security Token Service will then create the token:
    - If the token to be issued is of SAML type, then the Issuance Template will list how to populate the NameID, the Relying Party Partner Profile will list which attributes need to be sent in the token, the Issuance Template will indicate whether or not to translate the names and values of the attributes, the Issuance Template will indicate whether or not to sign/encrypt the token.
    - If the token to be issued is of SAML type, the Security Token Service server will examine the KeyType to determine the Subject Confirmation Method of the Assertion. If it is missing, it will use the Default Confirmation Method from the Issuance Template.
  10. Security Token Service will create the Response that the client will process:
    - Creates the WS-Trust RSTRC
    - Includes the returned token
    - Includes proof key if necessary

### 42.3.3 Configuration Requirements: Identity Propagation with the Username Token

The following topics describe the configuration requirements for the identity propagation scenario:

- [Configuration overview: Identity Propagation with the Username Token](#)
- [Default Identity Store Configuration](#)
- [Token Issuance Policy](#)
- [Endpoint Configuration](#)
- [Issuance Template Configuration](#)
- [Partner Configuration: Requester](#)
- [Partner Profile: Relying Party](#)
- [Partner Profile: Requester](#)

- [Validation Template for WS-TRUST](#)

### 42.3.3.1 Configuration overview: Identity Propagation with the Username Token

You can configure the Identity Propagation environment using the Username Token.

Following is an overview of the Identity Propagation environment and implementation tasks:

- A web application where the user will request. This web application will authenticate the user, then attempt to send a SOAP message to a remote Web Service Provider. As part of that SOAP exchange, the WS-Security client will download the WS-Security policy of the Web Service Provider, connect to the Security Token Service to retrieve the token requested by the Web Service Provider, send the Security Token with the SOAP message to the Web Service Provider.
- Security Token Service URL: `http://myhost.domain.com:14100/sts/<endpoint>`

---

---

**Note:**

Replace `<endpoint>` with the path configured in the STS Endpoints section.

---

---

The following Security Token Service configuration is required to implement token processing for identity propagation:

- One Requester Partner Profile
- One Relying Party Partner Profile
- One Issuance Template
- One WS-Trust Validation Template
- Security Token Service Endpoint
- An LDAP server is required for Security Token Service to map the Username token referencing the user to an LDAP User record, and thus use that record to populate the outgoing token.
- Ensure that the desired LDAP server is configured as the Default Identity Store for Access Manager.

### 42.3.3.2 Default Identity Store Configuration

[Figure 42-12](#) illustrates the Default Identity Store configuration within Oracle Access Management Console.

**Figure 42-12** Default Identity Store Defined for Access Manager

The screenshot shows the configuration page for the identity store 'dsee7'. The 'Store Name' is 'dsee7' and the 'Store Type' is 'IPlanet: Oracle Directory Server Enterprise Edition'. The 'Location' is 'auduin.us.oracle.com:5355'. The 'Bind DN' is 'cn=amldapuser,ou=DSAME Users,c' and the 'Password' is masked with asterisks. The 'Default and System Store Options' section indicates that this is the default store and it is set as the system store. The 'Users and Groups' section shows the 'User Name Attribute' as 'uid', 'User Search Base' as 'ou=people,dc=oracle,dc=com', 'Group Name Attribute' as an empty field, 'Group Search Base' as 'ou=groups,dc=oracle,dc=com', and 'Group Filter Classes' as an empty field.

### 42.3.3.3 Token Issuance Policy

You need to create the Token Issuance Policy for the resource URL within the IAM Suite Application Domain.

**Figure 42-13** Token Issuance Policy for Identity Propagation

The screenshot shows the 'Create Token Issuance Policy' page in the Oracle Access Management console. The page has tabs for 'Summary', 'Resources', 'Conditions', and 'Rules'. The 'Summary' tab is active, showing a form with a 'Name' field and a 'Description' field. The 'Name' field is empty and the 'Description' field is also empty. The page footer contains the copyright information: 'Copyright © 2000, 2013, Oracle and/or its affiliates. All rights reserved.' and the version number: 'Oracle Access Management Version: 11.1.2.2.0'.

Create the Token Issuance Policy for the resource URL within the IAM Suite Application Domain.

Figure 42-13 is a screen shot of the Token Issuance Policy page.

### 42.3.3.4 Endpoint Configuration

The /wss11 user Endpoint is required.

This is the one that you can use in the Web application to post the RST.

Figure 42-14 shows the Endpoint. The endpoint is protected by the default WS-Security Validation Template that is used in the Web application to post the RST.

**Figure 42-14 /wss11user Endpoint for Identity Assertion**

Row No.	Endpoint URI	Policy URI	Validation Template
1	/wssuser	oracle/wss_username_token_service_policy	username-wss-validation-template
2	/wss11user	oracle/wss11_username_token_with_message_protection_service_poli	username-wss-validation-template

### 42.3.3.5 Issuance Template Configuration

The Issuance Template requires configuration parameters such as **Token Type** and **Signing Key Id** for Identity Propagation.

Following is the required configuration:

- Name: saml-issuance-template
- Description: SAML issuance template
- Token Type: SAML 2.0
- Signing Key Id: osts\_signing

### 42.3.3.6 Partner Configuration: Requester

You can create a new Requester Partner configuration for Identity Propagation with the OAM token.

To create:

- Partner Name: requester-partner
- Partner Type: Requester
- Partner Profile: requester-profile
- Description: Requester
- Trusted
- Username Token Authentication
  - *Username* <enter username used by the Web Service Client>
  - *Password* <enter password used by the Web Service Client>
  - *Confirm Password* <enter password used by the Web Service Client>
- Identity Attribute values for:
  - httpbasicusername
  - sslclientcertdn

### 42.3.3.7 Partner Profile: Relying Party

You can create a new Relying Party Profile for Identity Propagation.

To create a new Relying Party Partner Profile:

- Profile ID: relying-party-profile
- Description: Relying Party Profile
- Default Token Type: SAML 2.0
- Issuance Template: iap-issuance-template for SAML 2.0

#### 42.3.3.8 Partner Profile: Requester

You can create a new Requester Profile for Identity Propagation.

Create a new Requester Partner Profile:

- Profile ID: requester-profile
- Description: Requester Partner Profile
- Default Relying Party Profile: relying-party-profile

#### 42.3.3.9 Validation Template for WS-TRUST

The Validation Template for WS-TRUST requires configuration parameters such as **Token Type** and **Enable Credential Validation** for Identity Propagation.

The configuration parameters required are the following:

- Validation Template Name: username\_wstrust\_validation\_template
- Description: Username WS-Trust Template
- Token Protocol: WS-Trust
- Token Type: Username
- Timestamp Lifespan: 600
- Enable Credential Validation: unchecked
- Token Mapping:
  - Map Token To User: checked
  - Enable Simple User Mapping: checked
  - Datastore Attribute: uid

#### Sample exchange: Request Security Token Sent By the Client

Here is a request for security token sent by the client.

```
<SOAP-ENV:Envelope xmlns:SOAP-ENV="http://schemas.xmlsoap.org/soap/envelope/"
xmlns:xsi="http://www.w3.org/1999/XMLSchema-instance">
<SOAP-ENV:Header><wsse:Security xmlns:wsse="http://docs.oasis-open.org/wss/2004/01/
oasis-200401-wss-wssecurity-secext-1.0.xsd">
<wsse:UsernameToken><wsse:Username>requester-test</wsse:Username><wsse:Password
Type="http://docs.oasis-open.org/wss/2004/01/oasis-200401-wss-username-token-
profile-1.0#PasswordText">welcome</wsse:Password></wsse:UsernameToken></
wsse:Security>
<wsa:Action xmlns:wsa="http://www.w3.org/2005/08/addressing">http://docs.oasis-
open.org/ws-sx/ws-trust/200512/RST/Issue</wsa:Action></SOAP-ENV:Header>
<SOAP-ENV:Body><wst:RequestSecurityToken xmlns:wst="http://docs.oasis-open.org/ws-
```

```

sx/ws-trust/200512"><wst:RequestType>http://docs.oasis-open.org/ws-sx/ws-trust/
200512/Issue</wst:RequestType>
<wst:TokenType>http://docs.oasis-open.org/wss/oasis-wss-saml-token-
profile-1.1#SAMLV1.1</wst:TokenType><wst:OnBehalfOf>
<wsse:UsernameToken xmlns:wsse="http://docs.oasis-open.org/wss/2004/01/oasis-200401-
wss-wssecurity-secext-1.0.xsd"><wsse:Username>user-alice</wsse:Username>
</wsse:UsernameToken></wst:OnBehalfOf></wst:RequestSecurityToken></SOAP-ENV:Body></
SOAP-ENV:Envelope>

```

This completes the configuration requirements for the Identity Propagation with Username Token scenario.

### Request Security Token Response sent by the Security Token Service

Here is a response to the RST sent by the Security Token Service.

```

<env:Envelope xmlns:env="http://schemas.xmlsoap.org/soap/
envelope/"><env:Header><Action xmlns="http://www.w3.org/2005/08/addressing">http://
docs.oasis-open.org/ws-sx/ws-trust/200512/RSTRC/IssueFinal</Action>
</env:Header><env:Body><wst:RequestSecurityTokenResponseCollection xmlns:ns6="http://
schemas.xmlsoap.org/ws/2004/08/addressing" xmlns:wsa="http://www.w3.org/2005/08/
addressing" xmlns:wsp="http://schemas.xmlsoap.org/ws/2004/09/policy"
xmlns:wsse="http://docs.oasis-open.org/wss/2004/01/oasis-200401-wss-wssecurity-
secext-1.0.xsd" xmlns:wst="http://docs.oasis-open.org/ws-sx/ws-trust/200512"
xmlns:wsu="http://docs.oasis-open.org/wss/2004/01/oasis-200401-wss-wssecurity-
utility-1.0.xsd">
<wst:RequestSecurityTokenResponse><wst:TokenType>http://docs.oasis-open.org/wss/
oasis-wss-saml-token-profile-1.1#SAMLV1.1</
wst:TokenType><wst:RequestedSecurityToken><saml:Assertion
AssertionID="id-1LNkSUVcpbH700oQwbHJ5J0d5fs-" IssueInstant="2011-04-22T18:48:05Z"
Issuer="myhost.uk.example.com" MajorVersion="1" MinorVersion="1" xmlns:dsig="http://
www.w3.org/2000/09/xmldsig#" xmlns:enc="http://www.w3.org/2001/04/xmlenc#"
xmlns:saml="urn:oasis:names:tc:SAML:1.0:assertion" xmlns:xsi="http://www.w3.org/2001/
XMLSchema-instance">
<saml:Conditions NotBefore="2011-04-22T18:48:05Z"
NotOnOrAfter="2011-04-22T19:48:05Z" /
><saml:AttributeStatement><saml:Subject><saml:NameIdentifier
Format="urn:oasis:names:tc:SAML:1.1:nameid-format:emailAddress">user-
alice@example.com</saml:NameIdentifier><saml:SubjectConfirmation>
<saml:ConfirmationMethod>urn:oasis:names:tc:SAML:1.0:cm:sender-vouches</
saml:ConfirmationMethod></saml:SubjectConfirmation>
</saml:Subject><saml:Attribute AttributeName="sn"
AttributeNamespace="urn:oracle:security:fed:attrnamespace"><saml:AttributeValue
xmlns:xs="http://www.w3.org/2001/XMLSchema" xsi:type="xs:string">user-alice-last</
saml:AttributeValue></saml:Attribute>
</
saml:AttributeStatement><dsig:Signature><dsig:SignedInfo><dsig:CanonicalizationMethod
Algorithm="http://www.w3.org/2001/10/xml-exc-c14n#" />
<dsig:SignatureMethod Algorithm="http://www.w3.org/2000/09/xmldsig#rsa-sha1" /
><dsig:Reference
URI="#id-1LNkSUVcpbH700oQwbHJ5J0d5fs-"><dsig:Transforms><dsig:Transform
Algorithm="http://www.w3.org/2000/09/xmldsig#enveloped-signature" />
<dsig:Transform Algorithm="http://www.w3.org/2001/10/xml-exc-c14n#" /></
dsig:Transforms><dsig:DigestMethod Algorithm="http://www.w3.org/2000/09/
xmldsig#sha1" />
<dsig:DigestValue>1GF2ZT9h+gs8sxy0+/yG/N6jxk8=</dsig:DigestValue></dsig:Reference></
dsig:SignedInfo>
<dsig:SignatureValue>InZVb5aRM5+KKI1VqXg9HiIgLjKyGm0Vkd6sMJ/
8S1bFbbxuNm7Mnky5W35p2P0c5bCPRx02uzLEE4KhLkyM2GsLsVaDnkRztGMphQW/
Mcg7DprJIEyR2OYMYDOQSipa/k2K98C4zO/RNivolKvyJsd6a3h6CBHwo01RKip039w=</
dsig:SignatureValue>
<dsig:KeyInfo><dsig:X509Data><dsig:X509Certificate>MIIB/

```

```
DCCAWWgAwIBAgIBCjANBgkqhkiG9w0BAQQFADAjMSEwHwYDVQQDEExhhZGMymTEwNjE4LnVzLm9yYWNsZS5jb2
0wHhcNMTEwNDE5MTUxNTI2WhcNMjEwNDE2MTUxNTI2WjAUMSEwHwYDVQQDEExhhZGMymTEwNjE4LnVzLm9yYWN
sZS5jb20wgZ8wDQYJKoZIhvcNAQEBBQADgY0AMIGJAoGBAJnSxVc86TGcwewieaueIVG33C3Qouve6HuJxHso
M8cRRkJcmv+0auyvDLJfYAEOfHo50sF4+za11iNPln9ZFaOjUy/
Y8JC0kSVxatgU36RveIrpOJvp9780a6IlMNutdFf8q3TrsizspE2hnbLY
+0SMofgnAPcJEKPxkd6b0b0ZAgMBAAGjQDA+MAwGAlUdEwEB/wQCMAAwDwYDVR0PAQH/
BAUDAwfYADAdBgNVHQ4EFgQU47ZqWHgTOMZO67uw4YzsbRmNOSwDQYJKoZIhvcNAQEBBQADgYEAHQIHaLMN
/7hd2VP0SLOctNdEmY5IqLY1CDW+GpUZZ9e+MCgE/rvr34566D9Q81vET6T9u+sg3h+hSkb3gE4a4wgShH/
V7nfHzx8ZntlxcvCZK6ePVDmt0Lfj2iVnE7IJxou4b00w0m9DrvyKop7ncnSEzaVpxIZgCDO7+8Zdw=</
dsig:X509Certificate>
</dsig:X509Data></dsig:KeyInfo></dsig:Signature></saml:Assertion></
wst:RequestedSecurityToken><wst:RequestedAttachedReference><wsse:SecurityTokenReferen
ce><wsse:KeyIdentifier Value="http://docs.oasis-open.org/wss/oasis-wss-saml-
token-profile-1.0#SAMLAssertionID">id-1LNkSUVcpbH700oQwbHJ5J0d5fs-</
wsse:KeyIdentifier></wsse:SecurityTokenReference></wst:RequestedAttachedReference>
<wst:RequestedUnattachedReference><wsse:SecurityTokenReference><wsse:KeyIdentifier
Value="http://docs.oasis-open.org/wss/oasis-wss-saml-
token-profile-1.0#SAMLAssertionID">id-1LNkSUVcpbH700oQwbHJ5J0d5fs-</wsse:KeyIdentifier></
wsse:SecurityTokenReference></wst:RequestedUnattachedReference>
<wst:Lifetime><wsu:Created>2011-04-22T18:48:05Z</
wsu:Created><wsu:Expires>2011-04-22T19:48:05Z</wsu:Expires></wst:Lifetime></
wst:RequestSecurityTokenResponse></wst:RequestSecurityTokenResponseCollection></
env:Body></env:Envelope>
```





---

# Configuring Security Token Service Settings

Administrators manage components that are needed for the protection of Security Token Service endpoints.

- [Prerequisites for the Configuration of Security Token Service Settings](#)
- [Introduction to Security Token Service Configuration](#)
- [Enabling and Disabling Security Token Service](#)
- [Defining Security Token Service Settings](#)
- [Using and Managing WSS Policies for Oracle WSM Agents](#)
- [Configuring OWSM for WSS Protocol Communication](#)
- [Managing and Migrating Security Token Service Policies](#)
- [Logging Security Token Service Messages](#)
- [Auditing the Security Token Service](#)

## 43.1 Prerequisites for the Configuration of Security Token Service Settings

Make sure that you review the following topics before you start to configure Security Token Service settings:

- [Introducing the Oracle Access Management Security Token Service](#)
- [Getting Started with Oracle Access Management](#)
- [Managing Server Registration](#)

## 43.2 Introduction to Security Token Service Configuration

Security Token Service, a Web Service co-existing with Access Manager, invokes some Access Manager components to validate and issue security tokens.

Typically, the Web client can use the Security Token Service to request an outbound token, such as SAML, by providing a security token, like a Username Token or an X.509 Token.

Security Token Service is integrated with the Oracle Access Management Console to provide a unified and consistent administration experience. All Security Token Service system configuration is done using the Oracle Access Management Console.

Security Token Service provides:

- Tokens:
  - Validation Tokens: Standard (Username, X.509, Kerberos, SAML 1.1/2.0) and custom tokens. OnBehalfOf use cases (OAM Session ID Propagation Token and custom tokens through the integration engine) also supports the following standard tokens along with OAM sessionID propagation token and custom token (Username, X.509, SAML 1.1/2.0).
  - Issuance Tokens: Standard (Username, SAML 1.1/2.0) and custom tokens through the integration engine
- Configuration-driven token issuance and validation
- Enhanced auditing through identity propagation across multiple tiers and domains
- Consolidated shared-platform service interacts with internal (Access Manager SSO, Federation, Oracle Web Services Manager) and external services

The following topics describe how to configure the Security Token Service settings:

- [Post-Installation Configuration](#)
- [About OAM Servers and Security Token Service](#)
- [About Security Token Service Clients](#)
- [About Agents and Security Token Service](#)

See *Administering Web Services* for more information.

## 43.2.1 Post-Installation Configuration

After you completed the installation and started the server, you can access the Oracle Access Management Console on the OAM Server.

For example, if the URL to the OAM Server is `http://machine:14100/oam`, you can access:

- Oracle Access Management Console at `http://machine:7001/oamconsole`
- Security Token Service: `http://machine:14100/sts/wss11user?wsdl` to view the WSDL of the `/sts/wss11user` endpoint that is available by default, to ensure that Security Token Service is available.

By default, Security Token Service is disabled and as such all runtime functionality as well as Web Service endpoints are disabled. To access those endpoints, Security Token Service must first be enabled using the Oracle Access Management Console. Afterwards, the endpoints might be accessed

### 43.2.1.1 Task Overview: Security Service Token

You need to perform the following post-installation configuration tasks::

1. For the **Server Side Configuration** on the Oracle Access Management Console, use the following:

- a. Service enablement

See [Enabling and Disabling Services for Security Token Service](#).

- b. Settings configuration  
See [Managing Security Token Service Settings](#).
  - c. Endpoint registration  
See [Managing EndPoints](#)
  - d. Token Issuance Template configuration  
See [Managing Token Issuance Templates](#)
  - e. Token Validation Template configuration  
See [Managing Token Validation Templates](#)
  - f. Partner Profile creation  
See [Managing Token Service Partner Profiles](#)
  - g. Partner configuration  
See [Managing Token Service Partners](#).
  - h. Token Issuance Policies to define an authorization rule for issuing tokens with Security Token Service, for a specific Relying Party.  
See [Managing Token Issuance Policies, Conditions, and Rules](#)
2. Set up interactions with the Oracle WSM Agent as described in following topics:
    - a. See [Using and Managing WSS Policies for Oracle WSM Agents](#).
    - b. See [Configuring OWSM for WSS Protocol Communication](#).
  3. Set up message logging.  
See [Logging Security Token Service Messages](#).
  4. Configure event auditing.  
See [Setting Up Auditing for Oracle Access Management](#).
  5. Configure lifecycle management
    - a. Register the Security Token Service trust endpoint, as described in item 1c.
    - b. Register the Requester or Relying Party Partner with Security Token Service.  
See [Managing Token Service Partners](#).
    - c. Monitor performance  
See [Monitoring Performance and Logs with Fusion Middleware Control](#) .

### 43.2.2 About OAM Servers and Security Token Service

With Oracle Access Management, all Security Token Service instances are installed on OAM Servers (also known as Managed Servers). Each server must be registered with Access Manager.

Security Token Service leverages the common infrastructure for shared services and the Oracle Access Management administration model. Security Token Service support Web Services Security protocol 1.0 and 1.1 and process the following tokens, if present in the Security SOAP headers:

- Username token (UNT)
- SAML 1.1 or SAML 2.0 Assertion
- Kerberos
- X.509

---

---

**Note:**

Managed servers that host Security Token Service must be registered with Access Manager.

See [Managing Server Registration](#) .

---

---

**Third-Party Servers:** Security Token Service interoperates with third party security token servers.

For example, a third party Security Token Service can create a valid Security Assertion Markup Language (SAML) Assertion that can be consumed by Security Token Service.

### 43.2.3 About Security Token Service Clients

Security Token Service provides services to various Oracle clients (Oracle Web Services Manager client) or third party clients (Microsoft and IBM are two).

**Oracle WSM Client:** Oracle Web Services Manager client bindings are the responsibility of Oracle Web Services Manager (and not in scope).

See [Configuring Oracle WSM Agent for WSS Kerberos Policies](#).

See "WS-Trust Policies and Configuration Steps" in *Administering Web Services*.

**Third Party Clients:** Require a secure key exchange between the Oracle WSM client and server. You simply import the Security Token Service certificate to the client.

During SOAP interactions, the WS-Security protocol might require the client to trust the signing/encryption certificate used for WSS operations by the OWSM Agent protecting the Security Token Service endpoint. In those cases, the Oracle Access Management Administrator should extract the Security Token Service OWSM signing/encryption certificate used for WSS operations and provide it to the WS Client.

See [Extracting the Oracle STS/Oracle WSM Signing and Encryption Certificate](#).

### 43.2.4 About Agents and Security Token Service

Oracle Web Services Manager communicates through agents that operate with Security Token Service.

**Oracle WSM Agent:** The Oracle Web Services Manager (Oracle WSM) Agent is integrated with Security Token Service. This agent provides the Web Services Security support for Security Token Service Web Services endpoints.

- Protects Web Services endpoints of Security Token Service
- Provides WS-Security support for sending SOAP messages to Relying Parties. As part of that process, the OWSM Client might interact with Security Token Service to get a security token that will be presented to the Relying Party

- Interacts with Security Token Service for token acquisition and token validation

Security Token Service supports token acquisition and token validation by Oracle Web Services Manager (Oracle WSM) agents. Oracle Web Services Manager Agents are not required to use Security Token Service as part of their inbound or outbound security policy enforcement. Oracle Web Services Manager client bindings are the responsibility of Oracle Web Services Manager Administrators.

The Oracle WSM Agent is used by Security Token Service to enforce message protection of the SOAP communication channel between Security Token Service and the client. The Oracle WSM Agent caches the OPSS Keystore (by default the default-keystore.jks keystore located in \$DOMAIN\_HOME/config/fmwconfig directory) which contains the trusted certificates involved when validating the WSS clients' certificates. Subsequent changes to the contents of the keystore or to its name, require a restart of the Managed Server using Oracle Enterprise Manager Fusion Middleware Control or WebLogic Server console, or NodeManager.

The Oracle WSM Agent available to Security Token Service must be configured to protect the Security Token Service endpoints, to perform the following tasks:

- Decrypt the request, if necessary
- Verify any digital signatures present in the request
- Validate any certificate used to create the request's digital signatures, if the signatures were created with a private key
- Validate any X.509 token, if present, in the SOAP headers
- Validate the Kerberos token, if present, in the SOAP headers
- Sign the outgoing response, if needed
- Encrypt the outgoing response, if required

**Oracle WSM Agent Keystore:** The Oracle WSM Agent uses a keystore for various cryptographic operations. For these operations, the Oracle WSM Agent uses the keystore configured for Oracle WSM tasks.

See [Introduction to Oracle Access Management Keystores](#).

See [Managing Security Token Service Certificates and Keys](#).

**Webgate:** Security Token Service uses Webgate for the Access Manager session propagation token. This, identity propagation, use case is more advanced. It requires the Identity Assertion Provider in WebLogic Server and some custom integration.

See [Security Token Service Implementation Scenarios](#) .

See "[About the Oracle Web Services Manager Keystore \(default-keystore.jks\)](#)"

## 43.2.5 About Security Token Service End Points and Policies

When you add an endpoint, you can choose from a list of Policy URI's and validation templates with which to associate the Security Token Service endpoint.

[Figure 43-1](#) shows the default settings for the Security Token Service with endpoints.

**Figure 43-1 Default Endpoints, Policies, and Validation Templates**

Endpoints Apply Reset

Actions

Id	Endpoint URI	Policy URI	Validation Template
1	/wss11user	sts/wss11_username_token_with_message_protection_service_policy	username-wss-valida
2	/wss11x509	sts/wss11_x509_token_with_message_protection_service_policy	x509-wss-validation-template
3	/wss10x509	sts/wss10_x509_token_with_message_protection_service_policy	x509-wss-validation-template
4	/wss10user	sts/wss10_username_token_with_message_protection_service_policy	username-wss-validation-template

The ORAPROVIDER is integrated with the Oracle WSM Agent, which provides Web Services Security support on the SOAP messages being exchanged between the client and Security Token Service. Security Token Service leverages ORAPROVIDER for Web Services to:

- Publish Web Services endpoints dynamically
- Invoke Security Token Service to process SOAP messages
- Publish a WSDL file for each WS endpoint

**Oracle WSM Agent WSS Policy Stores:** The Oracle WSM Agent requires a repository to retrieve the Web Services Security (WSS) policies it needs. Security Token Service supports two types of repositories:

- **JAR file with WSS Policies:** Used when the WLS Domain is configured for classpath.
- **Oracle WSM Policy Manager** available from the SOA deployment

**Policy Assertions:** Out of the box, Security Token Service provides a set of security policy assertions for use with the WS-Policy framework to describe how messages are to be secured in the context of Oracle Workspace Studio: SOAP Message Security and WS-Trust.

- Security Token Service makes its associated security policy files publicly available by attaching them to its deployed WSDL.
- Security Token Service runtime uses the private key and X.509 certificate pairs, stored in the keystores defined by the `jps-config.xml` file, for its WS-Security encryption and digital signature operations.

The following paragraphs and tables identify the policies that are available out of the box for Security Token Service and the Oracle WSM Agent.

**Message-level Security Not Required:** When message level-security is not required, use an Security Token Service policy that does not specify `message_protection` in its name. This authenticates users using credentials provided in tokens in the WS-Security SOAP header. The credentials in the Fusion Applications token are mapped based on the rules specified in the validation template. Both plain text and digest mechanisms are supported.

**Transport Security when Message-level Security Not Required:** You can configure two-way SSL where both the client applications and WebLogic server present certificates to each other.

You can configure two-way or one-way SSL for the core WebLogic Server security.

See Testing OWSM Security Policies in *Oracle Fusion Middleware Administering Web Services* guide.

See [Table 43-1](#) for policies.

#### Interoperability WS-Security 1.0 and 1.1 Policies:

- if you require interoperability with WS-Security 1.0 or 1.1 (depending on your authentication requirements and credential availability), you need to use the following policies:

See [Figure 43-2](#).

- If you have strong security requirements, you need to use WS-Security 1.1 policies.

**Figure 43-2 WS-Security 1.0 and 1.1 Policies**

```
sts/wss10_username_id_propagation_with_msg_protection_service_policy
sts/wss10_username_token_with_message_protection_service_policy
sts/wss10_username_token_with_message_protection_ski_basic256_service_policy
sts/wss11_username_token_with_message_protection_service_policy
sts/wss_username_token_over_ssl_service_policy
sts/wss_username_token_service_policy

sts/wss10_x509_token_with_message_protection_service_policy
sts/wss11_x509_token_with_message_protection_service_policy

sts/wss10_saml_hok_token_with_message_protection_service_policy
sts/wss10_saml_token_service_policy
sts/wss10_saml_token_with_message_integrity_service_policy
sts/wss10_saml_token_with_message_protection_service_policy
sts/wss10_saml_token_with_message_protection_ski_basic256_service_policy
sts/wss11_saml_token_with_message_protection_service_policy
sts/wss_saml_token_bearer_over_ssl_service_policy
sts/wss_saml_token_over_ssl_service_policy

sts/wss10_saml20_token_service_policy
sts/wss10_saml20_token_with_message_protection_service_policy
sts/wss11_saml20_token_with_message_protection_service_policy
sts/wss_saml20_token_bearer_over_ssl_service_policy
sts/wss_saml20_token_over_ssl_service_policy

sts/wss11_kerberos_token_service_policy
sts/wss11_kerberos_token_with_message_protection_basic128_service_policy
sts/wss11_kerberos_token_with_message_protection_service_policy

sts/wss11_sts_issued_saml_hok_with_message_protection_service_policy
sts/wss_sts_issued_saml_bearer_token_over_ssl_service_policy

sts/wss10_message_protection_service_policy
sts/wss11_message_protection_service_policy

sts/wss_http_token_over_ssl_service_policy
sts/wss_http_token_service_policy
```

#### 43.2.5.1 Task Overview: Using and Modifying WS-S Policies

You can use and modify a specific WS Security policy to protect the endpoint.

You need to perform the following tasks to use and modify WS-S policies:

1. In the Oracle Access Management Console, click **Federation** at the top of the window.
2. In the **Federation** console, select **Endpoints** from the **View** drop-down menu in the **Security Token Service** section.
3. Locate or create the endpoint to be protected.

See [Managing Security Token Service Endpoints](#).

4. In the Policy URI list, choose a specific WS Security policy to protect the endpoint that is described in the following topics:

See [Managing WSS Policies for Security Token Service: Classpath](#).

See [Managing WSS Policies for Security Token Service: Oracle WSM Policy Manager](#).

## 43.3 Enabling and Disabling Security Token Service

The following topics describe how to enable and disable Security Token Service:

- [About Security Token Service and the Oracle Access Management Console](#)
- [About Enabling Services for Security Token Service](#)
- [Enabling and Disabling Services for Security Token Service](#)

### 43.3.1 About Security Token Service and the Oracle Access Management Console

Elements in the Oracle Access Management Console enable Administrators to easily configure the Token Service to exchange WS Trust tokens with partners. All Security Token Service system configuration is done using the Oracle Access Management Console.

Token Service elements provide for creation, viewing, modification, and removal of partners, endpoints, validation templates, issuance templates, and data store connections. The configuration includes the following common tasks covered in [Managing Common and System Configurations](#) of this book:

- Registering and managing common OAM Servers and proxy information
- Registering and managing the common Default User Identity Store
- Configuring the OAM Keystore, which differs from the OWSM Keystore used for WSS processing
- Certificate Validation and Revocation

The Oracle Access Management Console enables Administrators to perform the following Security Token Service-specific tasks:

- Manage validation token templates: The validation templates include configuration properties to validate a Web Services Security/WSTrust token, and map it to a Requester Partner or a User record in the Default User Identity Store.
- Manage issuance templates: The issuance templates contain rules on how a token will be created
- Manage Partner Data: A partner represents a partner trusted by Security Token Service. Security Token Service defines three types of partners: Requester, Relying Party and Issuing Authority. Each partner entry is associated to a partner profile. The partner entry contains signing and encryption certificates and identifiers used to uniquely identify a partner
- Manage Partner Profile: A partner profile contains configuration properties that are common to a set of partners:
  - Claim Mapping



- Token Types definition
- Issuance and Validation templates defined for the token Types
- Override Validation Template rules for Issuing Authorities(Other STS)
- Manage Security Token Service Endpoints
- Manage Token Issuance Policies (authorization policies that will be evaluated to determine if a Requester Partner can request a token based on the Relying Party referenced in the request)
- Security Token Service Global Settings
- Custom tokens

#### 43.3.1.1 About Security Token Service Administrators

Users with administrative access to the Oracle Access Management Console, have access to Security Token Services.

Initially, administrative users must log in to the Oracle Access Management Console using the WebLogic Administrator credentials set during initial configuration. However, your enterprise may require independent sets of Administrators: one set of users responsible for Access Manager and another for Security Token Service.

#### 43.3.1.2 About Logging In To, and Signing Out Of, Security Token Service

When using Security Token Service with Access Manager, logging in to, and signing out of the Oracle Access Management Console is the same.

For more information on logging in and out of Oracle Access Management Console, See [About Logging Into the Oracle Access Management Console](#).

See [Logging Out of the Oracle Access Management Console](#).

### 43.3.2 About Enabling Services for Security Token Service

By default Security Token Service is disabled. If you want to use Security Token Service, both Security Token Service and Access Manager must be enabled.

A green check mark in the Status field beside the service name indicates the service is enabled. A red circle with a line through it indicates that the corresponding service is disabled.

### 43.3.3 Enabling and Disabling Services for Security Token Service

The following topics explain how to enable and disable services for Security Token Service:

- [Prerequisites for Enabling and Disabling Services for Security Token Service](#)
- [Enabling or Disabling Security Token Service](#)

#### 43.3.3.1 Prerequisites for Enabling and Disabling Services for Security Token Service

Oracle Access Manager service must be enabled.

By default Security Token Service is disabled. You need to enable the Oracle Access Manager service before enabling and disabling services for Security Token Service.

### 43.3.3.2 Enabling or Disabling Security Token Service

You can enable and disable a Security Token Service using Oracle Access Management Console.

To enable or disable Security Token Service:

1. In the Oracle Access Management Console, click **Configuration** at the top of the window.
2. In the **Configuration** console, click **Available Services**.
3. **Enable Security Token Service:** Beside Security Token Service, click **Enable** (or confirm that the Status check mark is green) and confirm that the Access Manager Service is also enabled.
4. **Disable Security Token Service:** Beside Security Token Service, click **Disable** (or confirm that the Status check mark is red).

## 43.4 Defining Security Token Service Settings

The following topics introduce:

- [About Security Token Service Settings](#)
- [Managing Security Token Service Settings](#)

### 43.4.1 About Security Token Service Settings

Security Token Service can be viewed or altered from the Security Token Service section of the System Configuration tab.

These settings are show in [Figure 43-3](#).

**Figure 43-3 Security Token Service Page**

**Security Token Service Settings** Apply Reset

The following settings apply to the Security Token Services (STS) service.

Partner Identification Attributes

Custom Trust Anchor File

\* Default Encryption Template

**Proxy**

Enabled

Host  Username

Port  Password

Non Proxy Hosts

**Keystore** + x

Keystore Location /scratch/prate/mwhome/user\_projects/domains/base\_domain/config/fmwconfig/iamkeystore

Row	Template Id	Alias	Password	Description
1	osts_encryption	stprivatekey	*****	
2	osts_signing	stprivatekeyalias	*****	

[Table 43-1](#) describes the elements on the Security Token Service Settings page.

**Table 43-1 Security Token Service Settings**

Element	Description
Partner Identification Attributes	<p>A field where you list attributes, other than the standard ones available by default, that should be available in "Identity Attributes" Table in the Partner page. These attributes can be used to identify a partner by matching their values against those in the incoming request.</p> <p>When a Requester sends a WS-Trust request to Security Token Service, the server might map the incoming token containing the requester's identity to a partner entry in the Security Token Service partner store.</p> <p>To do so, Security Token Service will use the mapping settings configured in a validation template and will attempt to map the token data to a partner entry by performing a lookup by matching the token data to a Partner Identification Attribute.</p> <p>By default, each requester partner contains three identification attributes that can be set: username, HTTP Basic Username, SSL Client Certificate DN.</p> <p>It is possible to define additional Identification Attributes that could be set for each requester partner entry.</p> <p>This section allows new attributes to be set. After defining a new attribute, it becomes available in the Requester Partner entry section, and it can be used in mapping rules in the WSS Validation Templates.</p>
Custom Trust Anchor File	<p>By default, Access Manager and Security Token Service use the default <code>\$DOMAIN_HOME/config/fmwconfig/amtruststore</code> keystore containing the trust anchors used for certificate validation by Security Token Service, when verifying X.509 Tokens, or when verifying certificates used in SAML Assertion signatures.</p> <p>It is possible to configure Security Token Service to use a specific trust anchor file if necessary, that will contain trust anchors only used for Security Token Service operations and validations. In this case, this field should contain the location of the JKS keystore to use.</p> <p>Note the following:</p> <ul style="list-style-type: none"> <li>• When using a custom trust anchor keystore, it will not be replicated automatically across the cluster. You must manage replication.</li> <li>• In most cases, the default Access Manager and Security Token Service trust anchor should be enough.</li> </ul> <p>See Also: <a href="#">Managing Security Token Service Certificates and Keys</a></p>
Default Encryption Template	<p>A list from which you choose the default template for Security Token Service encryption:</p> <ul style="list-style-type: none"> <li>• <code>osts_encryption</code></li> <li>• <code>osts_signing</code></li> </ul> <p>See Also: <a href="#">Setting the Default Encryption Key</a>.</p>

**Table 43-1 (Cont.) Security Token Service Settings**

Element	Description
Proxy	<p>Outbound Connection Properties, HTTP Proxy Settings Use this section to configure Security Token Service to use a proxy for outgoing HTTP connections when optionally retrieving the WS-Sec Policy of Relying Parties at runtime:</p> <ul style="list-style-type: none"> <li>• <b>Enabled:</b> When this box is checked the Proxy function is enabled and will be used when retrieving the WS-Security Policy of Relying Parties. When the box is not checked, the Proxy function is disabled and related fields are inaccessible for editing.</li> <li>• <b>Host:</b> The proxy hostname</li> <li>• <b>Port:</b> The proxy port number. Default is 8080</li> <li>• <b>Non Proxy Hosts:</b> A list of hosts for which the proxy should not be used. Use ';' to separate multiple hosts.</li> <li>• <b>Username:</b> The username to use when connecting to the proxy.</li> <li>• <b>Password:</b> The password to use when connecting to the proxy.</li> </ul>
Keystore	<p><b>Location:</b> Path of the active keystore that was set up during Security Token Service installation.</p> <p>The Keystore table includes the following information for each of the templates in the table, which are available for use as the Default Encryption Template:</p> <ul style="list-style-type: none"> <li>• <b>Template ID:</b> The name of the template that can access the keystore.</li> <li>• <b>Alias:</b> Identifies the alias for the template. When adding a template, you can choose from the Aliases listed.</li> <li>• <b>Password:</b> The password for the selected Alias.</li> <li>• <b>Description:</b> Optional.</li> </ul> <p>The keystore section defines key entries that exist in the Security Token Service keystore: <code>\$DOMAIN_HOME/config/fmwconfig/.oamkeystore</code></p> <p>After an entry is defined an entry, it can be used in other Security Token Service templates (like SAML Issuance Templates).</p>

## 43.4.2 Managing Security Token Service Settings

Users with valid Administrator credentials can use the following procedure to confirm or modify Security Token Service settings:

- [Prerequisites for Managing Security Token Service Settings.](#)
- [Viewing or Editing Security Token Service Settings.](#)

### 43.4.2.1 Prerequisites for Managing Security Token Service Settings

Both the Access Manager Service and the Security Token Service must be enabled.

### 43.4.2.2 Viewing or Editing Security Token Service Settings

In the Oracle Access Management Console, you can view or edit the settings of a Security Token Service through the Configuration console.

To view or edit Security Token Service settings:

1. In the Oracle Access Management Console, click **Configuration** at the top of the window.
2. In the Configuration console, select **Security Token Service** from the **View** drop-down menu in the **Settings** section.
3. On the Security Token Service Settings page view or modify the following information.

See [Table 43-1](#).

- Partner Identification Attributes
  - Custom Trust Anchor File
  - Proxy details
4. Keystore Table: View, add, or remove new encryption templates
  5. Click **Apply** to submit changes (or **Revert** to cancel changes).
  6. Close the page when finished.

## 43.5 Using and Managing WSS Policies for Oracle WSM Agents

You can use existing Oracle Workspace Studio policies to protect Security Token Service Web Service endpoints.

For instance:

- classpath mode: Existing Oracle Workspace Studio policies defined in `$ORACLE_IDM_HOME/oam/server/policy/sts-policies.jar` are used in this mode
- SOA deployment: Policies defined in the Oracle WSM Policy Manager available from a SOA deployment are used

The following topics describe how to manage Web Service Security Policies for Security Token Service:

- [Using and Modifying Oracle Workspace Studio Policies](#)
- [Managing WSS Policies for Security Token Service: Classpath](#)
- [Managing WSS Policies for Security Token Service: Oracle WSM Policy Manager](#)

### 43.5.1 Using and Modifying Oracle Workspace Studio Policies

WS-Security Policies protect Security Token Service WS Endpoint. You can modify these policies.

The WS-Security Policies that Oracle provides cover most use cases.

See [About Security Token Service End Points and Policies](#).

See "Attaching Policies to Web Services" in the *Administering Web Services*

## 43.5.2 Managing WSS Policies for Security Token Service: Classpath

Predefined Oracle Web Services Manager policies are constructed using assertions based on predefined assertion templates. For WSS Policy classpath mode, the OWSM Agent retrieves policies from `sts-policies.jar` located on the classpath.

If SOA is not deployed in the WebLogic Server domain, the Security Token Service installer configures the WebLogic Server domain for WSS Policy classpath mode. The JAR file containing the WSS Policies used when the WLS Domain is configured for classpath is located at:

```
$ORACLE_IDM_HOME/oam/server/policy/sts-policies.jar
```

When your environment is in classpath mode, perform the following tasks to Administrators confirm `sts-policies.jar` is located on the classpath.

See "[About Security Token Service End Points and Policies](#)".

See "Oracle WSM Predefined Policies and Assertion Templates" in the *Administering Web Services*

### 43.5.2.1 Task Overview: Managing WSS Policies for Security Token Service: Classpath

You need to perform the following tasks to manage WSS policies for Security Service: Classpath:

1. Define an OWSM Assertion Template.
2. Proceed as follows, depending on your need:
  - Modify an OWSM Policy
  - Define a Policy using the OWSM Assertion Template
3. Bundle the Assertion Template and policy in the `sts-policies.jar` file:

```
META-INF/assertiontemplates/oracle of the $ORACLE_IDM_HOME/oam/server/policy/sts-policies.jar
```
4. Confirm that `sts-policies.jar` is located in the following path to enable the policy URI to be available the Policy URI drop down list.

```
$ORACLE_IDM_HOME/oam/server/policy/sts-policies.jar
```
5. Restart the Managed Servers running Security Token Service.
6. Proceed to the Oracle Access Management Console to configure the Security Token Service Endpoints.

## 43.5.3 Managing WSS Policies for Security Token Service: Oracle WSM Policy Manager

The Oracle WSM Policy Manager is the security linchpin for Oracle Fusion Middleware Web services and SOA applications.

For more information about how the Oracle WSM Policy Manager manages the policy framework, See "Understanding Oracle WSM Policy Framework" in *Administering Web Services*.

At design time, you attach Oracle WSM and WebLogic Web service policies to applications programmatically using your favorite IDE, such as Oracle JDeveloper.

Alternatively, at deployment time you attach policies to SOA composites, ADF, and WebCenter applications using the Oracle Enterprise Manager Fusion Middleware Control, and to WebLogic Web services (Java EE) using the WebLogic Server Administration Console.

System Administrators can leverage the Oracle WSM through the Oracle Enterprise Manager Fusion Middleware Control to:

- Centrally define policies using the Oracle WSM Policy Manager.
- Enforce Oracle WSM security and management policies locally at run time.

When your environment is integrated with the OWSM Policy Manager, perform the following tasks to add or modify WSS policies for Security Token Service using Oracle Web Services Manager.

---

**Note:**

All of Oracle WSM's functionality is accessible to Administrators from Oracle Enterprise Manager Fusion Middleware Control.

---

See Part II, "Basic Administration" and Part III, "Advanced Administration" in the *Administering Web Services*.

#### **43.5.3.1 Task Overview: Managing WSS Policies for Security Token Service: OWSM Policy Manager**

You can locate and modify WSS policies for Security Service using the OWSM Policy Manager.

You need to perform the following tasks to manage WSS policies:

1. From the **OWSM Policy Manager**, locate and open the desired policy.
2. See the *Administering Web Services* and make any required changes to the policy.
3. Restart all Managed Servers running Security Token Service.
4. Proceed as follows:

See [Configuring OWSM for WSS Protocol Communication](#).

## **43.6 Configuring OWSM for WSS Protocol Communication**

You can configure communication between WS-Sec Clients and the Oracle WSM Agent that have been embedded with Security Token Service.

The Oracle WSM Agent protects the Web Service endpoints of Security Token Service, and provides support for WSS protocol exchanges. To ensure a client is communicating successfully with the Oracle WSM Agent:

- The client might need to be aware of the signing and encryption certificates used by the Oracle WSM Agent (this will require extracting and distributing the signing and encryption certificates used by the OWSM Agent embedded with Security Token Service).
- The Oracle WSM Agent needs to be aware, depending on the policies, of the signing certificate used by the client (this requires adding the client's certificate as a trusted certificate for the Oracle WSM Agent).

### 43.6.1 Task Overview: Configuring Communication with Oracle WSM Agents

You need to perform the following tasks to configure the communication with Oracle WSM agents:

1. [About Oracle WSM Agent WS-Security Policies for Security Token Service](#)
2. [Retrieving the Oracle WSM Keystore Password](#)
3. [Extracting the Oracle STS/Oracle WSM Signing and Encryption Certificate](#)
4. [Adding Trusted Certificates to the Oracle WSM Keystore](#)
5. [Validating Trusted Certificates in the Oracle WSM Keystore](#)
6. [Configuring Oracle WSM Agent for WSS Kerberos Policies](#)

See [Managing Security Token Service Certificates and Keys](#).

### 43.6.2 About Oracle WSM Agent WS-Security Policies for Security Token Service

The Oracle WSM Agent requires a repository to retrieve the Web Services Security (WSS) policies it needs.

Access Manager supports two types of repositories for Security Token Service:

- JAR file with WSS Policies: Used when the WLS Domain is configured for classpath. The required JAR file is located in `$ORACLE_IDM_HOME/oam/server/policy/sts-policies.jar`.
- Oracle WSM Policy Manager available from the SOA deployment

During Security Token Service installation, the installer detects if the Oracle Web Services Manager Policy Manager is present and deployed in the WebLogic Security domain.

- If not deployed in the WebLogic Security domain, the installer configures the WebLogic Security domain for the Web Services Security Policy classpath mode, where the WSM Agent will retrieve the policies from a JAR file.
- If present, the installer connects to the Oracle Web Services Manager Policy Manager and uploads the policies that are used to protect Security Token Service endpoints.

See [About the Database Store for Policy, Password Management, and Sessions](#) for details about the required database for Access Manager policy data and (optionally) Access Manager session data.

### 43.6.3 Retrieving the Oracle WSM Keystore Password

Administrators need to retrieve the keystore password and key entry password from CSF for certain activities.

Otherwise, keystore or key entry cannot be changed. Having access to the keystore is sometimes required to:

- Extract the signing/encryption certificate to distribute to clients if necessary
- Update or replace the signing/encryption key entry



- Add trusted certificates

### 43.6.3.1 Retrieving the Oracle WSM Keystore Password

You can retrieve the Oracle WSM keystore password by providing the connection information to the AdminServer.

The following procedure displays the password used to protect the Oracle WSM keystore as well as the key entry:

1. Enter the WSLT scripting environment.
2. Connect to the WebLogic Server AdminServer, using the `connect ( )` command.
3. Execute the following command by providing the connection information to the AdminServer: `listCred(map="OAM_STORE", key="jks")`.
4. Note the password.
5. Proceed as follows:

See "[Extracting the Oracle STS/Oracle WSM Signing and Encryption Certificate](#)".

## 43.6.4 Extracting the Oracle STS/Oracle WSM Signing and Encryption Certificate

During SOAP interactions, the WS-Security protocol might require the client to trust the signing/encryption certificate used for WSS operations by the OWSM Agent protecting the Security Token Service endpoint.

In those cases, the Oracle Access Management Administrator should extract the Security Token Service OWSM signing/encryption certificate used for WSS operations and provide it to the WS Client. The Administrator must export the signing and encryption certificate used by Security Token Service for WSS cryptographic operations. The following procedure guides as you do this by:

- Replacing `$DOMAIN_HOME` with the path to the Domain directory
- `CERT_FILE` with the location of the file where the certificate will be saved

If you are prompted to enter a password, simply press the Enter key.

### 43.6.4.1 Prerequisites for the Oracle STS/Oracle WSM Signing and Encryption Certificate

See [Retrieving the Oracle WSM Keystore Password](#).

### 43.6.4.2 Exporting the Signing and Encryption Certificate

You can locate the keytool and export the signing and encryption certificate.

To export the signing and encryption certificate:

1. Locate keytool.
2. Execute the following command.

```
keytool -exportcert -keystore $DOMAIN_HOME/config/fmwconfig/default-keystore.jks -storetype JKS -alias orakey -file $CERT_FILE
```

3. Enter the keystore password retrieved in the previous section if prompted.

4. Proceed as follows:

See "[Adding Trusted Certificates to the Oracle WSM Keystore](#)".

### 43.6.5 Adding Trusted Certificates to the Oracle WSM Keystore

You can add a trusted certificate to the OWSM keystore for WSS cryptographic operations.

To add a trusted certificate:

- Perform the command in the following procedure
- Replace the \$DOMAIN\_HOME with the path to the Domain directory
- Replace the TRUSTED\_CERT\_FILE with the location of the file containing the trusted certificate
- Replace the TRUSTED\_CERT\_ALIAS with the alias under which the trusted certificate will be stored

When prompted to enter a password, enter the password of the OWSM keystore that you retrieved earlier.

#### 43.6.5.1 Prerequisites for Adding Trusted Certificates to the Oracle WSM Keystore

The Administrator must have the certificate to import.

See [Retrieving the Oracle WSM Keystore Password](#).

#### 43.6.5.2 Adding Trusted Certificates to the Oracle WSM Keystore

You can locate the keytool and add trusted certificates to the Oracle WSM keystore.

To add trusted certificates to the Oracle WSM keystore:

1. Locate keytool.
2. Execute the following command.

```
keytool -importcert -trustcacerts -keystore $DOMAIN_HOME/config/fmwconfig/default-keystore.jks -storetype JKS -alias $TRUSTED_CERT_ALIAS -file $TRUSTED_CERT_ALIAS
```

3. Observe messages on the screen, enter a password if requested.
4. Proceed as follows:

See "[Validating Trusted Certificates in the Oracle WSM Keystore](#)".

### 43.6.6 Validating Trusted Certificates in the Oracle WSM Keystore

When the Oracle WSM Agent performs a certificate validation, it uses the keystore configured for Oracle WSM tasks, and will validate the certificate against the trusted certificate entries contained in the keystore.

For those operations, it might be required to add trusted certificate entries (the certificate itself or the issuer's certificate) in the OWSM keystore. When receiving a SOAP requester, the Oracle WSM Agent processes the request for message protection. Part of the steps might include a certificate validation operation if the incoming message:

- is of type WSS 1.0, and includes a digital signature created with a private key, without the certificate being present. In this case:

**Remedy:** The Oracle WSM keystore must contain the signing certificate.

- is of type WSS 1.0, and includes a digital signature created with a private key, with the certificate being present.

**Remedy:** The Oracle WSM keystore must contain either the signing certificate or the issuer's certificate of the signing certificate.

- is of type WSS 1.1, and includes a digital signature created with a private key, without the certificate being present.

**Remedy:** The Oracle WSM keystore must contain the signing certificate.

- is of type WSS 1.1, and includes a digital signature created with a private key, with the certificate being present. In this case, the OWSM keystore will need to contain either the signing certificate or the issuer's certificate of the signing certificate

**Remedy:** The Oracle WSM keystore must contain either the signing certificate or the issuer's certificate of the signing certificate

---

**See Also:**

[Managing Security Token Service Certificates and Keys](#)

---

### 43.6.7 Configuring Oracle WSM Agent for WSS Kerberos Policies

Security Token Service provides services to various Oracle clients (Oracle Web Services Manager client) or third party clients (Microsoft and IBM are two). The Oracle WSM Agent performs only message protection (not authentication) on the incoming request. The Oracle WSM agent does not attempt to map the incoming Kerberos ticket to a user record in the OPSS Identity Store.

If Oracle WSM is the client that will interact with Security Token Service using WSS Kerberos policies, then the entire Oracle WSM Kerberos setup section in *Administering Web Services* applies.

However, if the client is not Oracle WSM, disregard sections on how to configure the client, sections related to authenticating the user referenced in the Kerberos ticket.

The following procedure explains how to configure a non-Oracle WSM Client for WSS Kerberos policies:

1. Configure the KDC.
2. Initialize and Start the MIT Kerberos KDC.
3. Create Principals.
4. Configure the Web Service Client to Use the Correct KDC.

---

**Note:** Skip the following step 5 and step 6 for Non-Oracle Client.

---

5. Set the Service Principal Name In the Web Service Client.

6. Set the Service Principal Name In the Web Service Client at Design Time.
7. Configure the Web Service to Use the Right KDC.
8. Use the Correct Keytab File in Enterprise Manager.
9. Extract and Export the Keytab File.
10. Modify the krb5 Login Module to use the Keytab File.
11. Authenticate the User Corresponding to the Service Principal.
12. Create a Ticket Cache for the Web Service Client.
13. Use Active Directory with Kerberos and Message Protection.

---

---

**Note:** Skip step 14 for Non-Oracle Client.

---

---

14. Set Up the Web Service Client.
15. Create a User Account.
16. Create a Keytab File.

---

---

**Note:** Skip step 17 for Non-Oracle Client.

---

---

17. Set the Service Principal Name.
18. Set Up the Web Service.

## 43.7 Managing and Migrating Security Token Service Policies

You need to perform the following task to manage and migrate Security Token Service policies:

- [About Managing and Migrating Security Token Service Policies](#)
- [Managing Security Token Service Policies](#)
- [Migrating Security Token Service Policies](#)

### 43.7.1 About Managing and Migrating Security Token Service Policies

Security Token Service policies for endpoints reside in sts-policies.jar. This file lists all the policies packaged in the directory as file names to allow the server to read the JAR entries programmatically when migrating policies to destination repository.

This jar is copied to following location under \$WLS\_HOME (\$Oracle\_IDM1, for example):

`$WLS_HOME/oam/server/policy`

The sts-policies.jar contains the stspolicies.prop file at the following location in the JAR:

`META-INF/policies/sts/`

---

---

**Note:**

Be sure to update policies and stspolicies.prop as needed before migration.

---

---

## 43.7.2 Managing Security Token Service Policies

The following procedure outlines the various scenarios for policy updates.

### 43.7.2.1 Task Overview: Updating Policies and stspolicies.prop

You must perform the following tasks to update policies and stspolicies.prop

1. Add a Policy to sts-policies jar: Before creating the new jar, you must also update the stspolicies.prop file at META-INF/policies/sts/ to include this new policy file name.
2. Delete a Policy from sts-policies jar: You must also delete the entry from file META-INF/policies/sts/stspolicies.prop.
3. Update Existing Policy File Name: When re-naming a policy file at META-INF/policies/sts/, you must also update the corresponding entry in the file META-INF/policies/sts/stspolicies.prop file.
4. Update Existing Policy Content: When updating the content of a policy file, without touching the file name, there is no need to do anything else.

## 43.7.3 Migrating Security Token Service Policies

During installation a check is performed to establish whether SOA is deployed within the domain where Security Token Service is being installed. If SOA is installed, the Security Token Service Policies are migrated to the Oracle WSM PM repository.

- If SOA is not installed, the Oracle WSM protocol is set to classpath and policies are read from the JAR on the class path.

---

---

**See Also:**

["Using and Managing WSS Policies for Oracle WSM Agents"](#).

---

---

- If SOA is present within the domain, Security Token Service reads the policies from sts-policies.jar and migrates them to the Oracle WSM PM repository by calling Oracle WSM Mbeans.
- If SOA is installed after Security Token Service within the same domain, ensure smooth operations between SOA and Security Token Service as follows:
  - The Oracle WSM protocol must be set to 'remote'.
  - Security Token Service policies from sts-policies jar must be migrated to Oracle WSM PM repository using Oracle WSM provided tools.

## 43.8 Logging Security Token Service Messages

Logging is the mechanism by which components write messages to a file. Administrators can use the logging mechanism to capture critical component events.

Access Manager uses the same logging infrastructure and guidelines as any other component in Oracle Fusion Middleware 11g. This is accomplished by using the package `java.util.logging`, which is standard and available in all Java environments. The logging system writes output to flat files only. Logging to an Oracle Database instance is not supported.

Configuring logging and locating log files are the focus of this section. Diagnosing problems using the information in log files is outside the scope of this manual.

Log messages are used for problem diagnosis. The logging infrastructure records messages from Access Manager. The Administrator controls the amount of information that is logged in a message by specifying log levels for each component or service for which a logger is defined.

---

**Note:**

Generally, you enable logging to produce files that you send to Oracle Technical Support for problem diagnosis. Documentation for log messages is not available. In some cases, you might be able to diagnose problems on your own by reading log files.

---

By default, the log level for Access Manager is the Notification level. Logging at the Error level produces a small amount of output while other log levels can result in voluminous logging output, which can impact OAM performance. In production environments, logging is usually either disabled or the log level is set to a level that results in a small volume of logging output (the error level, for example).

Access Manager and Security Token Service uses the WebLogic container's logging defaults:

- **Logging File:** `$DOMAIN_HOME/servers/SERVER-NAME/logs/SERVER-NAME-diagnostics.log`
- **Logging Configuration File:** Provides logging level and other configuration information for logging. This file is stored in the following path:  
`$DOMAIN_HOME/config/fmwconfig/servers/SERVER-NAME/logging.xml`

## 43.9 Auditing the Security Token Service

Oracle Fusion Middleware auditing provides a measure of accountability and answers to the "who has done what and when" types of questions. Audit data can be used to create dashboards, compile historical data, and assess risks.

Analyzing recorded audit data allows compliance officers to perform periodic reviews of compliance policies. Configuring common auditing settings for Security Token Service and validating your auditing configuration is the subject of this section; analyzing and using audit data is outside its scope.

The Oracle Fusion Middleware Common Audit Framework supports auditing for a number of run-time events, and administrative events (changes to the system). It also provides uniform logging, and exception handling and diagnostics for all audit events.

While auditing can be enabled or disabled, it is typically enabled in production environments. Auditing has minimal performance impact, and the information captured can be useful (even mission-critical). The Auditing Framework uses configuration parameters set in the Oracle Access Management Console that enable data capture for a user or set of users.

Audit data can be written to either a single, centralized Oracle Database instance or to flat files. Regardless of where the audit record is stored, it contains a sequence of items that can be configured to meet particular requirements. The audit log file helps the audit Administrator track errors and diagnose problems if the audit framework is not working properly.

Additional information is available in the following topics.

- [About Security Token Service Audit Record Storage](#)
- [About Audit Reports and Oracle Business Intelligence Publisher](#)
- [About the Audit Log](#)
- [About Auditing Security Token Service Events](#)

---

---

**Note:**

Security Token Service integrates with Oracle Business Intelligence Publisher which provides a pre-defined set of compliance reports.

---

---

### 43.9.1 About Security Token Service Audit Record Storage

Security Token Service can be configured to write audit records to a variety of targets supported by the Common Audit Framework.

- Local flat files: By default, Security Token Service records audit data to a file.
- Central database: In production environments, Oracle recommends using a database audit store to provide scalability and high-availability for the Common Audit Framework. Audit data is cumulative and grows over time. Ideally this is a database for only audit data; not used by other applications.
- Platform-specific log (Linux Syslog and Windows Event Log)
- Audit Vault

To switch to a database as the permanent store for your audit records, you must first use the Repository Creation Utility (RCU) to create a database schema for audit data. The RCU seeds that database store with the schema required to store audit records in a database. After the schema is created, configuring a database audit store involves:

- Creating a data source that points to the audit schema you created
- Configuring the audit store to point to the data source

---

---

**See Also:**

- *Securing Applications with Oracle Platform Security Services*
  - ["Setting Up the Audit Database Store"](#)
  - ["Adding, Viewing, or Editing Audit Settings "](#)
- 
-

## 43.9.2 About Audit Reports and Oracle Business Intelligence Publisher

The data in the database audit store is exposed through pre-defined reports in Oracle Business Intelligence Publisher.

These reports allow you to drill down the audit data based on various criteria, such as user name, time range, application type, and execution context identifier (ECID).

Out-of-the-box, there are several sample audit reports available with Security Token Service and accessible with Oracle Business Intelligence Publisher. You can also use Oracle Business Intelligence Publisher to create your own custom audit reports.

---

---

**See Also:**

["About Audit Reports and Oracle Business Intelligence Publisher"](#)

---

---

## 43.9.3 About the Audit Log

An audit log file helps the audit Administrator track errors and diagnose problems when the audit framework is not working properly.

An audit log file records several fields including: Date, Time, Initiator, EventType, EventStatus, MessageText, ECID, RID ContextFields, SessionId, TargetComponentType, ApplicationName, and EventCategory to name a few.

---

---

**See Also:**

The topic on audit logs in the chapter on configuring and managing auditing in the *Securing Applications with Oracle Platform Security Services*

---

---

## 43.9.4 About Auditing Security Token Service Events

Specific administrative and run-time events that you can audit for Security Token Service are grouped together .

See [Auditing Administrative and Run-time Events](#).

Included with the events are the common instructions for setting up and validating auditing.

See the following topics for more details:

- [Security Token Service Events You Can Audit](#)
- [Setting Up Auditing for Oracle Access Management](#)
- [Validating Auditing and Reports](#)



---

## Managing Security Token Service Certificates and Keys

Administrators manage Security Token Service certificates and keys.

- [Prerequisites for Managing Security Token Service Certificates and Keys](#)
- [Introduction to Security Token Service Certificates and Keys](#)
- [Managing Security Token Service Encryption and Signing Keys](#)
- [Managing Partner Keys for WS-Trust Communications](#)
- [Managing Certificate Validation](#)

### 44.1 Prerequisites for Managing Security Token Service Certificates and Keys

Security Token Service services must run.

For more information, see [Enabling and Disabling Security Token Service](#).

### 44.2 Introduction to Security Token Service Certificates and Keys

Depending on the public key infrastructure, the digital certificate establishes credentials for Web-based transactions.

See [About Certificates, Authorities, and Encryption Keys](#).

**Public Keys at Run Time:** There are distinct cases where public key infrastructure materials are used at run time.

For example, during Web Services Security (WSS) protocol communication between Requesters and Security Token Service (with OWSM Agent).

[Table 44-1](#) describes the Security Token Service Public Keys that are used at run time.

**Table 44-1 Security Token Service Public Keys Used at Run Time**

When Security Token Service ...	Description
Issues SAML Assertions	<ul style="list-style-type: none"> <li>• Security Token Service Signing Assertions using a key defined in the STS Global settings</li> <li>• Security Token Service using the Requester's signing certificate as a proof key for Holder-of-Key of type Public Key confirmation method</li> <li>• Security Token Service using the Relying Party's encryption certificate to encrypt the secret proof key for Holder-of-Key of type Secret Key confirmation method</li> <li>• Security Token Service using the Requester's encryption certificate to encrypt a secret proof/entry in the RSTR for Holder-of-Key of type Secret Key confirmation method</li> </ul>
Issues tokens	<ul style="list-style-type: none"> <li>• Security Token Service uses the Relying Party's encryption certificate to encrypt the outgoing token</li> </ul>
Validates SAML Assertions	<ul style="list-style-type: none"> <li>• Security Token Service uses the Issuing Authority's signing certificate to verify the signature of the incoming SAML Assertion</li> </ul>
Uses Web Services Security (WSS) protocol communication	Between Requesters and Security Token Service (with OWSM Agent)

### 44.2.1 About Keystores and Security Token Service

The keystore files are distributed across all OAM Servers in the domain by the JMX framework and used for Security Token Service.

Following are the keystore files:

- `.oamkeystore`: For keys and certificates associated with OAM Server instances
- `.oamkeystore`: Partner Keystore for keys and certificates used to establish trust with partners, clients, and agents.
- `amtruststore`: Trust Keystore for keys and certificates that are used to establish trust in entities that are interacting with the OAM Server instances
- `amcrl.jar`: Certificate Revocation Lists (CRL) are used by the OAM Server instances when performing CRL-based certificate revocation checking

See [Introduction to Oracle Access Management Keystores](#).

The keystore files are distributed across all OAM Servers in the domain by the JMX framework. The `$DOMAIN_HOME/config/fmwconfig/mbeans` directory defines a registration `mbeans.xml` for each file that indicates the MBean to manage the file and also identify that the file should be propagated across the domain.

**Table 44-2 Keystore Mbeans**

Keystore	Mbean and Description
System/Partner Keystore: .oamkeystore	Configuration of the .oamkeystore is done using the JRE's keytool application.
Trust Keystore: .amtruststore	Configuration of the amtruststore is done using the JRE's keytool application.
CRL: amcrl.jar	CRL MBean: Can be used to manage CRLs.

The token security key pair is populated to the common keystore shared by Security Token Service. This eliminates the need for Oracle Web Services Manager agents to interact with the common keystore.

You can use a WLST command to retrieve the password for keystores and for the amtruststore.

See [Resetting System Keystore \(.oamkeystore\) and Trust Keystore \(amtruststore\) Password](#).

## 44.2.2 About the Oracle Web Services Manager Keystore (default-keystore.jks)

The keystore of type JKS is required by the Oracle WSM Agent to contain System and Partner keys and certificates.

Oracle WSM Agent functionality is available to Security Token Service to publish WS Policies and enforce message protection on inbound and outbound WS messages. Oracle WSM requires a separate keystore to contain System and Partner keys and certificates.

The Oracle WSM Agent uses a keystore for various cryptographic operations. For these tasks, the Oracle Web Services Manager Agent uses the keystore configured for Oracle Web Services Manager tasks (containing OWSM private keys and OWSM trusted certificates). The OPSS modules publish a keystore service used by Oracle Web Services Manager for certificate validation operations, and the \$DOMAIN\_HOME/config/fmwconfig/jps-config.xml will contain the settings for the keystore service. The default name is default-keystore.jks, which is specified in jps-config.xml.

Oracle strongly recommends that the Oracle WSM Agent keystore and the Security Token Service keystore always be different. Otherwise, keys could be available to any modules authorized by OPSS to access the keystore and Access Manager keys might be accessed.

---



---

### Note:

Oracle strongly recommends that the Oracle WSM Agent keystore and the Security Token Service keystore always be different.

---



---

During installation, if the Oracle WSM keystore service has not been configured, the installer:

- Creates a new keystore in the \$DOMAIN\_HOME/config/fmwconfig folder (default name is default-keystore.jks)

- Creates a key entry with the corresponding certificate that will be used by OWSM for signature and encryption operations. This key entry will be stored in the OWSM Keystore under the `orakey` alias
- Stores the passwords of the key entry and of the keystore in CSF

Having access to the keystore is sometimes required, to:

- Extract the signing/encryption certificate to distribute to clients if necessary
- Update or replace the signing/encryption key entry
- Add trusted certificates

See [Configuring OWSM for WSS Protocol Communication](#).

### 44.2.3 About Using the OPSS Keystore for Requester Certificates

For the special cases where clients use referencing schemes such as SKI (as opposed to a certificate token being received as part of the web service request), the requester's certificates need to be populated in the OPSS Keystore.

This is an uncommon scenario that requires manually provisioning keys to the OPSS keystore. See [About Agents and Security Token Service](#).

## 44.3 Managing Security Token Service Encryption and Signing Keys

Encryption and Signing Certificates stored in a keystore are used by the Security Token Service.

Security Token Service uses keys to:

- Sign outgoing Assertions
- Decrypt any incoming XML encrypted data contained inside the RST message (tokens, entropies...), which is not handled by the WSS Protocol

Security Token Service uses the following keystore for storing Encryption and Signing Certificates.

```
$DOMAIN_HOME/config/fmwconfig/.oamkeystore
```

### 44.3.1 Task Overview: Managing Security Token Service Encryption/Signing Keys

You need to perform the following tasks to manage Security Token Service keys:

1. [Resetting System Keystore \(.oamkeystore\) and Trust Keystore \(amtruststore\) Password](#)
2. [Adding a New Key Entry to the System Keystore \(.oamkeystore\)](#)
3. [Extracting an Security Token Service Certificate](#)

See [Configuring OWSM for WSS Protocol Communication](#).

### 44.3.2 Resetting System Keystore (.oamkeystore) and Trust Keystore (amtruststore) Password

You can reset the password that protects keystores, and the key entries that are using the same password as the keystore.

These keystores were created and configured during installation, as described in the *Oracle Fusion Middleware Installation Guide for Oracle Identity and Access Management*. The password and key entries password were randomly generated. The WLST `resetKeystorePassword` method allows the Administrator to set the `.oamkeystore` password and any key entries with a password identical to the `.oamkeystore` password to a new value:

- Updates the `.oamkeystore` password
- Updates the key entries in `.oamkeystore` that had the same password as the keystore
- Updates Access Manager, Identity Federation, and Security Token Service configuration to reflect the changes
- Updates the `amtruststore` password (if the keystore is protected by the same password as the default `.oamkeystore`)

See *WLST Command Reference for WebLogic Server*.

#### 44.3.2.1 Resetting System and Trust Keystore Passwords

You can reset system and trust keystore passwords through the WebLogic Server AdminServer.

To reset system and trust keystore passwords:

1. Enter the WSLT scripting environment, as usual.
2. Connect to the WebLogic Server AdminServer, using the `connect ( )` command.
3. Navigate to the domain runtime tree: `domainRuntime ( )`.
4. Execute the following: `resetKeystorePassword ( )`
5. Enter and confirm the password.

### 44.3.3 Adding a New Key Entry to the System Keystore (.oamkeystore)

An Administrator can add a new key entry into the System keystore (`.oamkeystore`) using the `keytool` command to create and add the new key entry.

Once the entry has been added, it must be defined in the Security Token Service configuration screen so that it can be used to sign assertions and decrypt incoming messages. The following topics describe how to add a new entry to sign SAML Assertions or decrypt XML-Encrypted data not covered by WSS:

- [Adding a New Entry](#)
- [Configuring a SAML Issuance Template to Use a Signing Key](#)
- [Setting the Default Encryption Key](#)

#### 44.3.3.1 Adding a New Entry

You need to configure a new entry to sign SAML Assertions or decrypt XML-Encrypted data not covered by WSS.

Before you begin, ensure that the Oracle Access Manager service is enabled.

To configure a new entry:

1. Locate keytool.
2. Either generate a self signed certificate or generate a certificate request, export the request to a remote Certificate Authority, and import the certificate issued by the Certificate Authority.
3. Observe messages on the screen.
4. Proceed as needed:
  - See [Configuring a SAML Issuance Template to Use a Signing Key](#).
  - See [Setting the Default Encryption Key](#).

#### 44.3.3.2 Configuring a SAML Issuance Template to Use a Signing Key

Users with valid Administrator credentials can edit an existing template to use a signing key.

To configure a SAML Issuance template to use a signing key:

1. Display the list of existing Token Issuance Templates.
  - Oracle Access Management Console
  - System Configuration
  - Security Token Services
  - Token Issuance Templates
2. Find and open the SAML issuance template that will use the new key. For example: `saml11-issuance-template`.
3. On the SAML Issuance Template page, click the Security tab.
4. On the Security tab, Signing And Encryption section, click Sign Assertion.
5. From the Signing Keystore Access Template Id list, choose the KeyID as the Signing Keystore Entry.
6. Click Apply at the top of the page to save this information.
7. Proceed as follows, if needed:

See [Setting the Default Encryption Key](#).

See [About Managing Token Issuance Templates](#).

See [Searching for an Existing Template](#).

#### 44.3.3.3 Setting the Default Encryption Key

Users with valid Administrator credentials can edit an existing template to use a signing key.

See [About Security Token Service Settings](#).

To set the default encryption key:

1. In the Oracle Access Management Console, click **Configuration** at the top of the window.

2. In the Configuration console, select **Security Token Service** from the **View** drop-down menu in the **Settings** section.
3. From the Default Encryption Template list, select the new key entry.
4. Click **Apply** at the top of the page to save this information.
5. Proceed as follows:
  - See [Setting the Default Encryption Key](#).

#### 44.3.4 Extracting an Security Token Service Certificate

You can use Certificate Retrieval Service to distribute the certificate of a key entry.

In some cases, it is required to distribute the Security Token Service keys used for SAML Signature operations or XML encryption operations:

- When a Relying Party needs to have access to the Security Token Service signing key, in order to validate the SAML Assertion issued by Security Token Service
- When a token needs to be encrypted for Security Token Service Server

To distribute the certificate of a key entry used by Security Token Service for SAML Signature operations or XML encryption operations, use the Certificate Retrieval Service by specifying the KeyID (listed in System Configuration, Security Token Service, Security Token Service Settings and the preferred encoding (der vs pem).

See [Using the Certificate Retrieval Service](#).

##### 44.3.4.1 Using the Certificate Retrieval Service

You can retrieve the KEYID of the entry and create a URL with it.

To use the Certificate Retrieval service.

1. Retrieve the KeyID of the entry for which the certificate should be retrieved (listed in Oracle Access Management Console System Configuration tab, Security Token Service section, Security Token Service Settings).
2. Create a URL.

For example: `http(s)://<osts-hostname>:<osts-port>/sts/servlet/samlcert?id=<KEYID>&encoding=<ENCODING>`, with:

- id holding the KeyID of the entry
  - encoding representing the format with which the certificate is returned. Possible values are pem (PEM format) or der (DER format). (optional, default value is pem)
3. Review the certificate that appears in the browser.

## 44.4 Managing Partner Keys for WS-Trust Communications

The following topics describe how to manage Partner Keys for WS-Trust communications:

- [About Partner Certificates](#)

- [About Downloading the Relying Party's Certificate at Run Time](#)
- [Setting the Partner's Signing or Encryption Certificate](#)

#### 44.4.1 About Partner Certificates

During the processing of the WS-Trust messages, Security Token Service might need to use a partner's certificate. During the processing of the WS-Trust messages, Security Token Service might need to use a partner's certificate.

[Table 44-3](#) lists the certificate that is needed contingent upon the situation.

**Table 44-3 Partner Keys for WS-Trust Communications**

If Security Token Service Must ...	The OAM Server ...
Issue a SAML Assertion encrypted for the Relying Party	Uses the Relying Party's encryption certificate to encrypt the outgoing token
Issue a SAML Assertion with the Subject Confirmation being of type Holder of Key / Asymmetric	Uses the Requester Partner's signing certificate as the proof key to be included in the Assertion Note: if the WS-Trust RST contains a UseKey element referencing an X.509 Binary Security Token in the SOAP header that was used in a signature, then Security Token Service will be able to use this certificate as the proof key.
Issue a SAML Assertion with the Subject Confirmation being of type Holder of Key / Symmetric	Uses the Relying Party's encryption certificate to encrypt the secret proof key to be included in the Assertion.
Issue a SAML Assertion with the Subject Confirmation being of type Holder of Key / Symmetric	Can encrypt in the RSTR for the Requester, the secret or the server entropy. In this case, the server: <ul style="list-style-type: none"> <li>• uses the Requester's encryption certificate to encrypt the secret (if the secret was generated using only server entropy)</li> <li>• or uses the server entropy to encrypt the secret in the RSTR (if the secret was derived from client and server entropy).</li> </ul> Note: if the WS-Trust RST contains a ProofEncryption element referencing an X.509 Binary Security Token in the SOAP header that was used in a signature, then Security Token Service will be able to use this certificate to encrypt the secret or entropy returned to the client.
Validate an incoming SAML Assertion	Uses the Issuing Authority's signing certificate to verify the XML digital signature present on the Assertion.

#### 44.4.2 About Downloading the Relying Party's Certificate at Run Time

At runtime, Security Token Service is capable of downloading the Relying Party WSS Policy of the service listed in the AppliesTo field of the RST.

If Security Token Service is configured to download the Relying Party's WS-Sec policy, then ensure that the Proxy settings are correctly entered, if needed, so that Security Token Service can connect to the Relying Party. If the Relying Party Partner Profile is



configured to do so, it instructs Security Token Service to download the WS-Sec Policy from the service. Security Token Service then extracts the certificate located in the policy and uses it for cryptographic operations, if necessary. Also:

- If Security Token Service issues a SAML Assertion encrypted for the Relying Party, the server uses the certificate downloaded from the Relying Party's WS-Sec Policy to encrypt the outgoing token.
- If Security Token Service issues a SAML Assertion with the Subject Confirmation of type Holder of Key / Symmetric, Security Token Service uses the certificate downloaded from the Relying Party's WS-Sec Policy to encrypt the secret proof key to be included in the Assertion.

You can configure the Relying Party Partner Profile so it downloads the certificate at run time.

See [Setting the Partner's Signing or Encryption Certificate](#).

### 44.4.3 Setting the Partner's Signing or Encryption Certificate

You can set the signing or encryption certificate of a partner using the Federation console.

*Alternatively:* Use the WLST Partner commands to set the signing or encryption certificate of a specific partner.

See [Table 44-3](#) for the prerequisites of Setting the Partner's Signing or Encryption Certificate.

To set the certificate of a partner:

1. In the Oracle Access Management Console, click **Federation** at the top of the window.
2. In the Federation console, select **Partners** from the **View** drop-down menu in the **Security Token Service** section.
3. Select the desired tab (**Requesters**, **Relying Parties** or **Issuing Authorities**)  
See [Table 44-3](#).
4. Search for and open (or Create) the Partner for which the certificate must be set.
5. Edit Partner settings as needed.  
See [Managing Token Service Partners](#) and click Save.
6. **Encryption Certificate:** Click the Browse button to locate and choose the Encryption certificate.
7. **Signing Certificate:** Click the Browse button to locate and choose the Signing certificate.
8. Save the information and close the page.
9. Proceed with "[Managing Certificate Validation](#)".

## 44.5 Managing Certificate Validation

Certificate validation requires the Trust Anchors Store (.amtruststore).

### Conditions for Security Token Service Certificate Validation (OSTS Certificate Validation Criteria)

STS validates a certificate when:

- The security token to be validated is one of the following types:
  - X.509
  - X.509v3
  - PKCS#7
- A SAML Assertion must be validated.
- Security Token Service is configured to validate the signing certificate of a SAML Issuing Authority.

Table 44-4 lists the successful validation requirements.

**Table 44-4 Successful Certificate Validation Requirements**

Certificates Must ...	How ...
Be linked to a trusted anchor:	<ul style="list-style-type: none"> <li>• by being a trusted anchor</li> <li>• or by having its issuer being a trusted anchor</li> </ul>
Not be revoked: <ul style="list-style-type: none"> <li>• by being a trusted anchor</li> <li>• or by having its issuer being a trusted anchor</li> </ul>	The revocation status of a certificate can be decided by checking: <ul style="list-style-type: none"> <li>• Against a list of CRLs that were uploaded by the Administrator</li> <li>• Against an OCSP server</li> <li>• CRL Distribution Points</li> </ul>

You need to perform the following tasks to manage this store and validation:

- [Managing the Trust Anchors Store \(amtruststore\)](#)
- [Managing Certificate Revocation Lists](#)
- [Using a Custom Trust Anchor Store for Security Token Service](#)

#### 44.5.1 Managing the Trust Anchors Store (amtruststore)

The Trust Anchors keystore is managed using the keytool command.

Certificates added to the keystore are detected by the Certificate Validation module.

---

**Note:**

Notification is performed by using the JMX Notification Framework and may take some time, depending on the notification refreshing time (60 seconds by default).

---

Prerequisites for Managing the Trust Anchors Store (amtruststore)

See [Resetting System Keystore \(.oamkeystore\) and Trust Keystore \(amtruststore\) Password](#).

To manage the Trust Anchors Store (amtruststore)

1. Locate keytool.
2. Execute the following command.

```
keytool -keystore $DOMAIN_HOME/config/fmwconfig/amtruststore
-storetype JKS -alias orakey -file $CERT_FILE
```

3. Observe messages on the screen and enter a password if requested.
4. Proceed as follows:

See [Managing Certificate Revocation Lists](#).

## 44.5.2 Managing Certificate Revocation Lists

Security Token Service uses the common infrastructure certification validation module. Trusted Certificates and Certificate Revocation Lists (CRLs) used during certificate validation are stored in Trust Keystore and CRL ZIP file.

The Security Token Service configuration stores the OCSP/CDP settings. You can add or remove certificate revocation lists (CLRs) to check the revocation status of a certificate, perform the following operations.

See [Certificate Validation and Revocation](#).

### 44.5.2.1 Prerequisites for Managing Certificate Revocation Lists

You need to have your Certificate Revocation List ready so you can import it.

### 44.5.2.2 Task Overview: Manage Certificate Validation and Revocation Lists

You must perform the following tasks to manage Certificate Validation and Revocation lists:

1. From the Oracle Access Management Console System Configuration tab, Common Configuration section, select Certificate Validation.
2. See [Enabling the Certificate Revocation List Functionality](#).
3. See [Enabling OCSP Certificate Validation](#) :
4. See [Enabling CRL Distribution Point Extensions](#).

## 44.5.3 Using a Custom Trust Anchor Store for Security Token Service

Optionally, if a particular deployment requires a set of trust anchors separate from that of Access Manager, another keystore can be configured as the trusted certificate store for Security Token Service.

This can be done by having the Administrator perform the following tasks.

---

---

**Note:**

---

---

### **44.5.3.1 Task Overview: Deploying a Custom Keystore for Trusted Certificates**

You can deploy a custom keystore for a Trusted Certificate.

To deploy a custom keystore:

1. Create the JKS keystore in the `$DOMAIN_HOME/config/fmwconfig` directory.
2. In the Oracle Access Management Console, Security Token Service Settings page, enter the full path name of the new trust store and Apply your changes.
3. In the domain where Security Token Service is deployed, the Custom Trust Anchor Keystore must be propagated manually by the Administrator across all the servers.

---

# Managing Templates, Endpoints, and Policies

Enable the Security Token Service to manage templates, Endpoints, and policies.

See [Enabling and Disabling Security Token Service](#). The following topics provide information about managing the templates, endpoints and policies for the Security Token Service.

- [Introduction](#)
- [Searching for an Existing Template](#)
- [Managing Token Issuance Templates](#)
- [Managing Token Validation Templates](#)
- [Managing Security Token Service Endpoints](#)
- [Managing Token Issuance Policies, Conditions, and Rules](#)
- [Managing TokenServiceRP Type Resources](#)
- [Making Custom Classes Available](#)
- [Managing a Custom Security Token Service Configuration](#)

## 45.1 Introduction

The Security Token Service controls who can access a Web Service Provider (WSP) by defining Application Domains that provide access to resources based on configured policies.

Application Domains identify Web Services and the authorization rules that determine who can request a security token.

The following functionality is established by Trust Issuance Policies. A Trust Issuance Policy can be managed by clicking the Application Domains link from the Oracle Access Management Console Launch Pad.

- Resource of type TokenServiceRP representing Relying Parties or Web Service Providers.
- Token Issuance Policy defining a policy for a set of resources of type TokenServiceRP.
- Condition defining the identities of the clients that are allowed or denied issuance of tokens for the resources listed in the policy. The clients can either be Requester Partners or User from the Default Identity Store.

Security Token Service supports the creation of Relying Party Partner, representing a remote Web Service Provider that will be the consumer of a security token issued by Security Token Service.

For each Relying Party Partner, it is possible to define URLs that will be mapped to the partner, so that WS-Addressing endpoint specified in a WS-Trust Request can be mapped to an Security Token Service Relying Party Partner.

At runtime, when a client requests a token to be issued, Security Token Service will evaluate the Trust Issuance Policies to determine whether or not the token can be issued:

- The client will be identified either as a Requester Partner or as an end user
- If an AppliesTo element was present in the WS-Trust Request and was mapped to a Relying Party Partner, then the TokenServiceRP resource for the Trust Issuance Policy evaluation will be the Partner ID of that Security Token Service Relying Partner.
- If an AppliesTo element was present in the WS-Trust Request and could not be mapped to a Relying Party Partner, then the TokenServiceRP resource for the Trust Issuance Policy evaluation will be the UnknownRP defined in the Access Manager Application Domain.
- If an AppliesTo element was missing in the WS-Trust Request, then the TokenServiceRP resource for the Trust Issuance Policy evaluation will be the MissingRP defined in the Access Manager Application Domain.

Security Token Service requires the following items (at a minimum) to process a request and issue a token based on an incoming request (RST):

- EndPoints
- One Issuance Template
- One Validation Template
- One Requester Partner Profile that contains the token
- One Relying Party Partner Profile

---

---

**Note:**

Partners might need to be provisioned.

---

---

An LDAP server is required for the Security Token Service to map the Username token that references the user to an LDAP User record, and then use that record to populate the outgoing token. Partners might need to be provisioned before they are available.

## 45.2 Searching for an Existing Template

All defined template names appear in the Search Results Table when you open either the Token Validation Template or Token Issuance Template node. To quickly find a specific template or set of templates, you can use the Search controls.

This section explains the controls you can use to refine your search, which are similar whether you are searching for a Token Validation Template or a Token Issuance Template. It includes the following topics:

- [About Template Search Controls](#)
- [Searching For a Template](#)

### 45.2.1 About Template Search Controls

The Search Controls are used to quickly find a specific template or set of templates. In validation and Issuance templates, the available Search Controls for search pages are mostly similar.

The following figures show the search pages where you will see many similarities:

- [Figure 45-1](#)
- [Figure 45-2](#)

**Figure 45-1 Validation Templates Search Controls**

**Validation Templates** + New Validation Template

Use the search tool to find validation templates or click the New Validation Template button to create a new validation template

**Search**

Match  All  Any

Validation Template Name: Contains [ ] Token Type: Equals [ ]

Description: Contains [ ]

Token Protocol: Equals [ ]

Search Reset Add Fields Reorder

**Search Results**

Actions View + New Duplicate Edit Delete

Row	Validation Template Name	Description	Token Protocol	Token Type
1	username-wstrust-validation...		WS-Trust	Username
2	x509-wss-validation-template		WS-Security	X509
3	username-wss-validation-te...		WS-Security	Username

**Figure 45-2 Issuance Template Search Controls**

**Issuance Templates** + New Issuance Template

Use the search tool to find Issuance Templates or click the New Issuance button to create a new Issuance Template.

**Search**

Match  All  Any

Issuance Template Name: Contains [ ]

Description: Contains [ ]

Token Type: Equals [ ]

Search Reset Add Fields Reorder

**Search Results**

Actions View + New Duplicate Edit Delete

Row	Issuance Template Name	Description	Token Type
1	saml11-issuan...		SAML 1.1
2	saml20-issuan...		SAML 2.0

Table 45-1 describes the controls available to refine a template search. Unless explicitly stated, all elements are available for both Validation and Issuance Template searches.

**Table 45-1 Search Validation Template**

Element	Description
Match	Choose All to search for a template that matches all your specifications. Choose Any to search for a template that matches at least one of your specifications.
Search Operations List	A list of operations from which you choose one to help refine your search.
... Template Name	Choose an operation from the list and enter information in the field to help refine your search.
Description	Refine your search using the optional description field.
Token Protocol Validation Template only	Choose the token protocol from those listed: <ul style="list-style-type: none"> <li>• WS-Trust</li> <li>• WS-Security</li> </ul>
Token type	Choose the token type. Both standard and custom token types are included. <ul style="list-style-type: none"> <li>• Username: Consumption and Creation</li> <li>• X.509: Consumption</li> <li>• SAML: Consumption &amp; Creation</li> <li>• OAM 11g: Consumption using the OBO (on behalf of) field</li> <li>• Kerberos: Consumption</li> <li>• Custom: Consumption the OBO (on behalf of) field and Creation</li> </ul>
Search	Initiates the Search function using criteria in the form.
Reset	Resets the Search form with defaults only.
Add Fields	A list of additional items you can add as search criteria.
Search Results Table	Itemizes the results of your search based on choices in the View menu, described later in this table.
Actions menu <i>Shown: Actions for Validation Template</i>	Provides the following functions that can be performed on a selection in the results table: Note: Actions menu functions mirror command buttons above the results table. For example: <ul style="list-style-type: none"> <li>• New ... Template: Click the New ... Template button at the top of the Search page, or select New ... Template from the menu, or click the + button above the table.</li> <li>• Edit: Click a name in the Results Table, or select Edit from the Actions menu, or click the Edit (pencil) command button above the Results Table.</li> <li>• Create Like: Select the desired row in the table and either select Create Like from the Actions menu, or click the Create Like command button above the table</li> <li>• Remove: Select the desired row in the Results Table and either select Delete from the Actions menu, or click the Delete (X) command button above the table.</li> </ul>
View menu Validation Template only	A list from which you can identify Validation Template information to display in the results table.
View menu Issuance Template only	A list from which you can identify Issuance Template information to display in the results table.



**Table 45-1 (Cont.) Search Validation Template**

Element	Description
Up-Down Arrows	Controls you can choose to define the order of items listed in the results table: <ul style="list-style-type: none"> <li>• Ascending</li> <li>• Descending</li> </ul>

## 45.2.2 Searching For a Template

Users with valid Administrator credentials can search controls to locate a specific template or set of templates.

For example, to locate all templates of a certain token type you can simply choose the type of token. To refine the search further to all templates of a specific token type and name. When performing these steps, fill in as much or as little as you want. Skip any steps that do not apply to you.

---



---

### See Also:

["About Template Search Controls "](#)

---



---

To search for a template:

1. In the Oracle Access Management Console, click **Federation** at the top of the window.
2. In the Federation console, select **Token Validation Templates** or **Token Issuance Templates** the **View** menu in the **Security Token Service** section.
3. Edit Search Criteria ([Table 45-1](#)). For example:
  - Match: All
  - Name: contains em
  - Token Type: equals Username
4. Click **Search**, review results, and click the one you want to open.

## 45.3 Managing Token Issuance Templates

An issuance template contains rules on how a token will be created and is specific to a token type.

Each issuance template indicates Signing and Encryption and also contains Attribute Name, Value Mapping, and Filtering settings to be sent as part of the token. This section provides the following information:

- [About Managing Token Issuance Templates](#)
- [Managing a Token Issuance Template](#)

### 45.3.1 About Managing Token Issuance Templates

Each Token Issuance Template indicates how to construct a token.

In other words, which signing or encryption to use when constructing a token. Each Token Issuance Template also defines the attributes mapping and filtering rules to be applied to the attributes that will be included in the outgoing token. However, Issuance Templates do not list the attributes that will be sent in the outgoing token: these are defined in the Relying Party Partner Profile.

Token Issuance Template details which will differ depending on your chosen token type. [Table 45-2](#) describes where to find more information.

**Table 45-2 Issuance Template Requirements**

Topic	Figures and Tables
General Details	<a href="#">Figure 45-3</a> , <a href="#">Table 45-3</a>
Issuance Properties: Username Tokens	<a href="#">Figure 45-4</a> , <a href="#">Table 45-4</a>
Issuance Properties: SAML Tokens	<a href="#">Figure 45-5</a> , <a href="#">Table 45-6</a>
Security: SAML Tokens	<a href="#">Figure 45-6</a> , <a href="#">Table 45-6</a>
Attribute Mapping: SAML Tokens	<a href="#">Figure 45-9</a> , <a href="#">Table 45-7</a>

**General Details**

[Figure 45-3](#) shows the New Issuance Template page with defaults showing. Unless explicitly stated, General information is the same regardless of the Token Type you choose. For more information, see [Table 45-3](#). After you fill in General information and click Save, you cannot return and edit the template name or token type.

**Figure 45-3 Issuance Template: General Details and Defaults**

**New Issuance Template** Token Issuance Template Save Cancel

Specify the basic information about the new Issuance template. Token properties and other details can be added after the template is created.

\* Issuance Template Name

Description

Token Type

Send Encrypted Token

Token Encryption Algorithm

**Table 45-3 Issuance Template: General Details**

Elements	Description
Issuance Template Name	Enter a unique name for this template.
Description	Optional.
Token Type	Choose a standard (or custom, if any) token type from those listed.
<i>SAML, Username, and Custom Token Types</i>	
Send Encrypted Token	Click to enable token encryption.

**Table 45-3 (Cont.) Issuance Template: General Details**

Elements	Description
Token Encryption Algorithm	When token encryption is enabled, choose a Token Encryption Algorithm from those listed.

**Issuance Properties: Username Token Type**

If the token type is Username, the Issuance Properties shown in [Figure 45-4](#) are needed for a Username token type template.

**Figure 45-4 Issuance Properties: Username Token Type**

[Table 45-4](#) describes the Issuance Properties for the Username token type.

**Table 45-4 Issuance Properties: Username Token Type**

Element	Description
Name Identifier User Attribute	Attribute to be used to populate the Username element in the Username Token.
Name Identifier User Attribute Store	Choose the user attribute store type: <ul style="list-style-type: none"> <li>• Userstore</li> <li>• Context</li> </ul> Note: If the Attribute Store is the Userstore, LDAP is used to retrieve the attribute from the user record. If the Attribute Store is context, data from the incoming token is used as the attribute source.
Password Attribute	Attribute to be used to populate the Password element in the Username Token.

**Table 45-4 (Cont.) Issuance Properties: Username Token Type**

Element	Description
Password Attribute Store	<p>Choose the password attribute store type:</p> <ul style="list-style-type: none"> <li>Userstore</li> <li>Context</li> </ul> <p>Note: If the Attribute Store is the Userstore, LDAP is used to retrieve the attribute from the user record. If the Attribute Store is context, data from the incoming token is used as the attribute source.</p>
Include Nonce	<p>Indicates whether or not a Nonce made of random data should be included in the Username token.</p> <p>Default: Disabled</p>
Include Timestamp	<p>Indicates whether or not a the Created element should be included in the Username token.</p> <p>Default: Disabled</p>

**Issuance Properties: SAML Token Types**

SAML 1.1 and 2.0 token types require the issuance properties illustrated in [Figure 45-5](#).

**Note:**

These issuance properties differ from those for Username token type.

**Figure 45-5 Issuance Properties: SAML Token Types**

The screenshot shows a configuration interface with the following elements:

- Tabs: General, **Issuance Properties**, Security, Attribute Mapping
- Assertion Issuer: test.oracle.com
- Name Identifier Format: Email Address
- Name Identifier Qualifier: (empty)
- Name Identifier User Attribute: mail
- Name Identifier User Attribute Store: Userstore
- Include Authentication Statement:
- Include Attribute Statement:
- Validity Period: 3600

[Table 45-5](#) describes all Issuance Properties by token type. Only SAML token types require issuance properties.

**Table 45-5 Issuance Properties: SAML Token Types**

Element	Description
Assertion Issuer	Specifies the identifier representing the issuer of the assertion. This string is used to represent this Security Token Service as the issuer of the assertion.
Name Identifier Format	Choose a format from the list and then enter the details in the text field. Options may include Custom, Kerberos Principal Name, Unspecified, X509 Subject Name and others.
Name Identifier Qualifier	Contains the string that will be set as the Name Identifier Qualifier.
Name Identifier User Attribute	References the attribute that will be used to populate the value of the Name Identifier.
Name Identifier User Attribute Store	<ul style="list-style-type: none"> <li>Userstore</li> <li>Context</li> </ul> <p>Note: If the Attribute Store is the Userstore, LDAP is used to retrieve the attribute from the user record. If the Attribute Store is context, data from the incoming token is used as the attribute source.</p>
Include Authentication Statement	<p>Indicates whether or not a SAML Authentication Statement should be included in the Assertion.</p> <p>Default: Disabled</p> <p>Note: An authentication operation is required for a statement of this type to be included. An authentication statement will be included if the incoming token contained some authentication data and that those were validated (for example, the incoming SAML Assertion contains an authentication statement, or a Username Token contains credentials that were validated).</p>
Include Attribute Statement	<p>Indicates whether or not a SAML Attribute Statement will be included in the outgoing Assertion.</p> <p>A statement of this type will be included only if this flag is set to true and if at least one attribute is included in the outgoing Assertion.</p> <p>Default: Enabled</p> <p>Note: the RP PP will determine which attributes need to be included in an outgoing token.</p>
Validity Period	<p>Specify the length of time (in seconds) that the token will be valid.</p> <p>Default: 3600 (seconds)</p>

**Security Details: SAML Tokens**

Only SAML token types require Security Details.

See [Figure 45-6](#).

See [Table 45-6](#).

**Figure 45-6 Security Details: SAML Tokens**

**Table 45-6 Security Details: SAML Tokens**

Elements	Description
<b>Signing And Encryption</b>	Indicates whether or not the Assertion will be signed using the Key referenced by the Signing Keystore Access Template ID field.
Sign Assertion	Indicates whether or not the assertion will be digitally signed with a certificate. Default: Enabled
Include Certificate in Signature	Indicates whether or not the signing certificate will be included in the Assertion. Default: Enabled
Signing Keystore Access Template Id	References the key to be used to sign assertions created with this issuance template. The key templates are defined in the Security Token Service Settings section.
Send Encrypted Name Identifier	Indicates whether the encrypted token name identifier will be sent as part of the digital assertion signature.
<b>Subject Confirmation</b>	

**Table 45-6 (Cont.) Security Details: SAML Tokens**

Elements	Description
Default Subject Confirmation Method	Indicates which Subject Confirmation Method will be used by default, if the requester did not specify a method in the WS-Trust request. Possible values are: <ul style="list-style-type: none"> <li>• Bearer</li> <li>• Holder of Key with Public Key</li> <li>• Holder of Key with Symmetric Key</li> <li>• Sender Vouches</li> </ul>
Compute Holder-of-Key Symmetric Key	Default: Enabled Indicates whether or not Security Token Service will generate random data when creating the Secret Key for the Holder of Key Symmetric Key data. <ul style="list-style-type: none"> <li>• If true, the server will generate the secret key if the client did not specify entropy. Otherwise it will derive the key from the client and server entropy</li> <li>• If false, the client entropy will be used as the secret key</li> </ul>
Encrypt RSTR Proof Token	Indicates whether or not the Proof Token must be encrypted when returning the server entropy or secret key to the requester in the WS-Trust response, when the Subject Confirmation method is Holder of Key with Symmetric Key Default: Disabled
Holder-of-Key Symmetric Key Generation Algorithm	Select the symmetric key generation algorithm that will be used to create the secret key when the Subject Confirmation method is Holder of Key with Symmetric Key:

**Attribute Mapping: SAML Tokens**

When the token type is SAML 1.1 or 2.0, it is possible to define attribute mapping and filter rules that will be applied to the attributes included in the Assertion.

There are three different rules:

- Attribute name mapping where the local name of an attribute can be changed to another value. For example, givenname can be changed to firstname.
- Attribute value mapping where the local value of an attribute can be translated to another value. For example, President to CEO.
- Attribute value filtering where the local value of an attribute can be filtered so it is not included in the outgoing assertion. For example, some sensitive attribute values could be removed while others would be issued.

**See Also:**

Token Mapping attributes in [Figure 45-9](#) and [Table 45-11](#).

**Table 45-7 Issuance Template: Attribute Mapping, SAML Token**

Element	Description
Attribute Name Mapping	<p data-bbox="672 327 1321 415">Defines an optional mapping between the local name of an attribute, and the name used to reference this attribute in the assertion.</p> <p data-bbox="672 432 1365 615">The mapping is optional. If an attribute does not have a mapping defined, then its local name will be used, and the namespace will be set to <code>urn:oracle:security:fed:attrnamespace</code> for SAML 1.1 Assertions or the format will be set to <code>urn:oasis:names:tc:SAML:2.0:attrname-format:basic</code> for SAML 2.0 Assertions.</p> <ul data-bbox="672 632 1321 915" style="list-style-type: none"> <li data-bbox="672 632 1300 688">• External Attribute: Contains the external name of the attribute as it will appear in the Assertion.</li> <li data-bbox="672 699 1321 724">• Local Attribute: Contains the local name of the attribute.</li> <li data-bbox="672 735 1300 915">• Format of Namespace: Contains an optional Format or Namespace. If missing, the namespace will be set to <code>urn:oracle:security:fed:attrnamespace</code> for SAML 1.1 Assertions or the format will be set to <code>urn:oasis:names:tc:SAML:2.0:attrname-format:basic</code> for SAML 2.0 Assertions.</li> </ul>
Attribute Value Mapping	<p data-bbox="672 947 1341 1003">Defines an optional value mapping for an attribute that will be included in the Assertion.</p> <p data-bbox="672 1020 1365 1140">Note: this attribute value mapping applies to an Attribute Name mapping. In order to define an attribute mapping for an attribute, it is required to first define an attribute name mapping for that attribute.</p> <ul data-bbox="672 1157 1365 1514" style="list-style-type: none"> <li data-bbox="672 1157 1365 1245">• External Attribute: Contains the value that should be included in the Assertion, if the local attribute value matches the Local Attribute/Local Null fields.</li> <li data-bbox="672 1255 1321 1281">• Local Attribute: Contains the local value of the attribute.</li> <li data-bbox="672 1291 1341 1379">• External Null: Indicates if the value to be included in the Assertion should be null, if the local value of the attribute matches the Local Attribute/Local Null fields.</li> <li data-bbox="672 1390 1159 1415">• Local Null: Represents a null local value.</li> <li data-bbox="672 1425 1365 1514">• Ignore Case: Indicates whether or not Security Token Service should ignore case when comparing the attribute value to the Local Attribute field.</li> </ul>



**Table 45-7 (Cont.) Issuance Template: Attribute Mapping, SAML Token**

Element	Description
Attribute Value Filters	<p>Defines an optional value filtering for an attribute that will be included in the Assertion.</p> <p>Note: This attribute value filtering applies to an Attribute Name mapping. In order to define an attribute filtering for an attribute, it is required to first define an attribute name mapping for that attribute.</p> <ul style="list-style-type: none"> <li>• Condition: Contains the condition associated with the expression to determine whether or not the attribute value should be filtered. The possible values are described in "<a href="#">Attribute Value Condition Filters</a>".</li> <li>• Expression: Contains data that will be used to evaluate the filtering rule.</li> <li>• Ignore Case: Indicates whether or not Security Token Service should ignore case when comparing the attribute value to the expression field.</li> </ul>

#### Attribute Value Condition Filters

This optional value filtering applies to an Attribute Name mapping and will be included in the Assertion. To define an attribute filtering for an attribute, you must first define an attribute name mapping for that attribute. The Condition is associated with the expression to determine whether or not the attribute value should be filtered. The possible Condition values are:

- **regex**: the expression will contain a regular expression, and if it evaluates to true, the attribute value will be filtered.
- **equals**: if the attribute value matches the data contained in the expression field, then it will be filtered.
- **not-equals**: if the attribute value does not match the data contained in the expression field, then it will be filtered.
- **not-equals**: if the attribute value does not match the data contained in the expression field, then it will be filtered.
- **endswith**: if the attribute value ends with the data contained in the expression field, then it will be filtered.
- **contains**: if the attribute value contains an occurrence of the data contained in the expression field, then it will be filtered.
- **not-contains**: if the attribute value does not contains any occurrence of the data contained in the expression field, then it will be filtered.
- **equals-null**: if the attribute value is null, then it will be filtered.
- **not-equals-null**: if the attribute value is not null, then it will be filtered.

## 45.3.2 Managing a Token Issuance Template

Users with valid Oracle Access Management Administrator credentials can develop a new Token Issuance Template or edit an existing template.

Skip any steps that do not apply to you. The following procedure describes how to create a new Token Issuance Template for a Security Assertion Markup Language (SAML) token.

### Prerequisites for Managing a Token Issuance Template

Confirm that the desired LDAP Identity Store is registered with and configured as the Default Store.

---

---

**See Also:**

- [About Managing Token Issuance Templates](#)
  - [Searching for an Existing Template](#)
- 
- 

To create a new token issuance template:

1. In the Oracle Access Management Console, click **Federation** at the top of the window.
2. In the Federation console, select **Token Issuance Templates** the **View** menu in the **Security Token Service** section.
3. **New Token Issuance Template:**
  - a. Click the **New Issuance Template** button in the upper-right corner (or click the **Add (+)** button above the Search Results table).
  - b. **General:** Define general information for this template.  
See [Table 45-3](#).
  - c. Click **Save** and dismiss the confirmation window (or click **Cancel** without saving).
  - d. **Username Token Type:** Define issuance parameters for this template.  
See [Table 45-4](#)
  - e. **SAML Token Type:** Define parameters for this template.  
See [Table 45-5](#)  
See [Table 45-6](#)  
See [Table 45-7](#)
  - f. Click **Apply** (or click **Revert** without saving it).
  - g. Close the definition.
4. **Find an Existing Template:** From the Token Issuance Templates page:

- a. **Find All:** review the results table. All templates are returned by default when you access the Issuance Templates page.
  - b. **Narrow the Search:** Specify your search criteria and click the **Search** Button, and review the results table.  
See [Table 45-1](#).
  - c. **Reset the Search Form:** Click the **Reset** button.
5. **Edit a Template:** Start with the saved page you just created.  
*Alternatively:* Use Step 3 to find the desired template and click the name in the Search Results table to display the definition.
  - a. Edit details as needed.
  - b. Click the **Apply** button at the top of the page to submit changes (or **Revert** to undo your changes).
6. **Remove a Template:**
  - a. Click the desired name in the Search Results table to select the item to remove.
  - b. From the **Actions** menu, click **Delete** (or click the **Delete (X)** command button above the table).
  - c. Click the **Delete** button in the Confirmation window (or click **No** to cancel the operation).

## 45.4 Managing Token Validation Templates

A validation template is used to validate an incoming token.

It is optionally used to map the incoming token to either a Requester Partner or a user record:

- For OnBehalfOf use cases, a WS-Trust Validation Template must be present.
- For validating an Assertion, one Issuing Authority Partner Profile must be present.

The Security Token Service Endpoint is linked to a WSS Validation Template that indicates how to validate the token in the WSS header and how to map the token and binding data to a Requester.

This section provides the following topics.

- [About Managing Token Validation Templates](#)
- [Managing Token Validation Templates](#)

### 45.4.1 About Managing Token Validation Templates

A Security Token Service Endpoint is always mapped with a WS-Security Validation Template that indicates how to map the request to a requester entry or to a user

- If mapping is required and no match is found, processing will fail.
- If no mapping is required, a default requester partner profile will be used.

- In either case, a requester partner profile is retrieved.
- If a mapping is performed to a user record, a default requester partner profile will be used.
- If a mapping is performed to a requester partner entry, the requester partner profile for this partner will be used.

A validation template determines the token validation rules:

- Whether or not to validate and map the incoming token.
- The mapping rules to be used if mapping is enabled.

A validation template is specific to a token type and specific to a protocol as described in [Table 45-8](#).

**Table 45-8 Validation Template Protocols**

Protocol	Description
WS-Security	<p>Validates only WS-Security Tokens:</p> <ul style="list-style-type: none"> <li>• Possible Mapping actions: no action, map binding data to partner, map incoming token to partner, map incoming token to user and binding data to partner, map incoming token to user</li> <li>• Token Types supported: SAML 1.1, SAML 2.0, Username X.509, Kerberos, None.</li> </ul> <p>When you toggle the Token Protocol from WS-Trust to WS-Security, options in the Token Type list do not change. However, the required "Default Partner Profile" list appears from which you must choose one profile for WS-Security.</p>
WS-Trust	<p>Validates only Tokens included in OBO (on behalf of) field of the RST (request):</p> <ul style="list-style-type: none"> <li>• Possible Mapping actions: none, map incoming token to user</li> <li>• Token Types supported: SAML 1.1, SAML 2.0, Username, X.509, Kerberos, OAM, Custom.</li> </ul>

A validation template mapping rules determines how the incoming data is mapped to a user or a partner, using data from the incoming token:

- Username for Username Token
- UserID for Kerberos Token
- NameID and attributes for SAML Token
- DN Components for X.509 Token
- Attributes from a Custom

Mapping is performed as follows:

- Simple mapping: one incoming attribute matched against one user record attributes
- Complex LDAP query: LDAP query with placeholders for incoming data (e.g.: (&(sn=%lastname%)(mail=%email%))
- NameID Mapping table for SAML Token

Figure 45-7 illustrates default General details on the New Validation Template page.

**Figure 45-7 New Validation Template page: General Page Defaults**

Table 45-9 describes the elements on the New Validation Template, General page.

**Table 45-9 New Validation Template: General Details**

Element	Description
Back	Click this button to return to the previous page.
Next	Click this button to proceed to the next page.
Cancel	Click this button to dismiss the page.
Validation Template Name	The name you choose for this template. For example: email-wstrust-valid-temp
Description	Optional.
Token Protocol	The type of Validation Template to be created. Type can be either: <ul style="list-style-type: none"> <li>WS-Trust: This template will be used to validate and map tokens included in the OnBehalfOf element of the WS-Trust request.</li> <li>WS-Security: This template will be used to validate and map tokens located in the Security SOAP Header of the incoming message</li> </ul>
Token Type	A list of in-bound token types from which you choose the one to use for this template. The token type options depends on the protocol type: <ul style="list-style-type: none"> <li>WS-Trust: SAML 1.1, SAML 2.0, Username, X.509, Kerberos, OAM, Custom</li> <li>WS-Security: SAML 1.1, SAML 2.0, Username, X.509, Kerberos, None</li> </ul>

**Table 45-9 (Cont.) New Validation Template: General Details**

Element	Description
Default Partner Profile	<p>Only applies to WS-Security Validation Template</p> <p>References the default requester partner profile to use, in case the incoming request is not mapped to a requester partner. For example, if the request is mapped to a user instead.</p> <p>A requester partner profiles contains settings that are used during the request processing. If the incoming request was mapped to a requester partner, then the partner profile for that requester will be retrieved and used as the requester partner profile</p>
Timestamp Lifespan	<p>Applies only to Username and SAML Validation Templates. It determines the validity time of a Token (for Username Token, only if it contains a Created element indicating the instant it was created).</p> <p>Default: 1000 (seconds)</p>
<b>Authentication Details</b>	Specific to username token validation template.
Enable Credential Validation	<p>Check this box to enable validation using credentials contained in the username token.</p> <p>When enabled, Security Token Service will validate the username and the password elements contained in the username token, using the specified validation source.</p> <p>Note: password digest as defined in the Username Token WS-Security Profile is not supported in this release.</p> <p>See Also: <a href="#">Table 45-10</a></p>

[Figure 45-8](#) illustrates the General details page when Enable Credential Validation is checked.

As a result, the Authentication Details section of the page you can view its default values. This is specific to username token validation.

**Figure 45-8 New Validation Template: General Authentication Details**

Table 45-10 describes Authentication related details that are available when you choose Enable Credential Validation.

**Table 45-10 New Validation Template: Authentication Details**

Element	Description
Validation Source	<p>A list from which you can choose a credential validation sources</p> <p>There are four types of validation sources when validating the credentials contained in a username token:</p> <ul style="list-style-type: none"> <li>• LDAP: a standalone LDAP server will be used to validate the credentials. The connection information will need to be entered</li> <li>• Embedded LDAP: the LDAP server embedded in the WebLogic server will be used to validate the credentials. No information is required.</li> <li>• Userstore: the default User Identity Store configured in the Common Configuration -&gt; Data Sources will be used to validate the credentials. No information is required in this validation template screen</li> <li>• Partner: the credentials will be verified against the username/ password information entered in the Requester Partner entries.</li> </ul> <p>Note: When selected, the Token Mapping configuration section is disabled, because the token will have been mapped to a requester partner after the credentials validation operation.</p>
LDAP URL	The URL of the LDAP server.
Admin User	The username of an account used to perform lookups in the LDAP server.

**Table 45-10 (Cont.) New Validation Template: Authentication Details**

Element	Description
Admin Password	The password of an account used to perform lookups in the LDAP server.
Base DN	The Base search DN used when looking up user records.
Enable HA	Indicates whether or not the LDAP server is in HA mode, fronted by a load balancer.
Person Object Class	The person object class associated with the user records.
Unique Id	The attribute of the user record containing the user unique identifier data. In most cases, is identical to the Credential ID field.
Credential Id	The attribute of the user record containing the username data. This field will be used to lookup user records, based on the username.
Maximum Connections	The maximum number of concurrent opened LDAP connections Default: 50
Connection Wait Timeout	Maximum amount of time to wait when opening a new connection. Default: 5000 (seconds)
Connection Inactivity Timeout	Maximum amount of inactivity time for an LDAP connection, before closing it. Default: 5000 (seconds)
Connection Read Timeout	Maximum number of concurrent opened LDAP connections. Default: 5000 (seconds)

### Token Mapping

The Token Mapping section indicates the following:

- If an incoming token needs to be mapped.
- If the incoming token needs to be mapped, what kind of mapping is done. For example, mapping token to user, mapping token to partner, and so on.
- How the mapping is done. For example, by mapping a token attribute to a partner/user attribute, or by using an LDAP query involving several token attributes.

Mapping rules determine how the incoming data is mapped to a user or a partner. The following data of the incoming token is used:

- Username for UNT
- UserID for Kerberos
- NameID and attributes for SAML
- DN Components for X.509
- Attributes from custom



Mapping is performed using the following:

- Simple mapping: One incoming attribute matched against one user record attributes.
- Complex LDAP query: An LDAP query with placeholders for incoming data. For example, `(&(sn=%lastname%)(mail=%email%))`
- A NameID Mapping table for SAML

Following are several Token Mapping Examples for a new Validation Template:

- [Figure 45-9](#)
- [Figure 45-10](#)
- [Figure 45-11](#)

[Figure 45-9](#) shows the mapping configuration settings.

They are required for Security Token Service to map the token to a user record, by matching the NameID value to user records that have a matching attribute, based on the following NameID format:

- Enable Map Token to User
- Enable Simple User Mapping
- Disable Attribute Based User Mapping

**Figure 45-9 Token Mapping: SAML2 WS-Security Validation Template**

**New Validation Template: Token Mapping** Token Validation Template

Back ← ● ● → Save Cancel Next

General Token Mapping

Map Token To: Map token to User

Enable Simple User Mapping

User Token Attribute: Name ID

Datastore Attribute:

Enable User Name Identifier Mapping

Row	Name Identifier	User Attribute
1	urn:oasis:names:tc:SAML:1.1:nameid-format:WindowsDomainQualifiedName	
2	urn:oasis:names:tc:SAML:1.1:nameid-format:X509SubjectName	
3	urn:oasis:names:tc:SAML:1.1:nameid-format:emailAddress	
4	urn:oasis:names:tc:SAML:1.1:nameid-format:unspecified	
5	urn:oasis:names:tc:SAML:2.0:nameid-format:kerberos	

Number of Rows: 6

Enable Attribute Based User Mapping

Enable Simple Partner Mapping

Partner Token Attribute:

Partner Datastore Attribute:

Enable Partner Name Identifier Mapping

Row	Token Attribute	Datastore Attribute
1	urn:oasis:names:tc:SAML:1.1:nameid-format:WindowsDomainQualifiedName	
2	urn:oasis:names:tc:SAML:1.1:nameid-format:X509SubjectName	
3	urn:oasis:names:tc:SAML:1.1:nameid-format:emailAddress	
4	urn:oasis:names:tc:SAML:1.1:nameid-format:unspecified	
5	urn:oasis:names:tc:SAML:2.0:nameid-format:kerberos	

Figure 45-10 shows the mapping configuration settings.

They are required for Security Token Service to map the token to a user record by matching the username element of the Username token to a user record that has a matching uid.

The required settings are:

- Enable Map Token to User
- Enable Simple User Mapping
- Datastore Attribute set to uid
- Disable Attribute Based User Mapping

**Figure 45-10 Token Mapping, username-wstrust-validation-template**

The screenshot shows the configuration interface for a token validation template. At the top, the template name 'username-wstrust-validation-template' is displayed with a green checkmark icon, followed by the text 'Token Validation Template' and 'STS\_VALIDATION\_EDIT\_INSTRUCTIONS'. Below this, there are two tabs: 'General' and 'Token Mapping', with 'Token Mapping' being the active tab. The configuration options include:

- Map Token To User
- Enable Simple User Mapping
- A text input field labeled 'Datastore Attribute' containing the value 'uid'.
- Enable Attribute Based User Mapping

At the bottom of the configuration area, there is a greyed-out section with a small grid icon in the bottom right corner.

Figure 45-11 shows the mapping configuration settings.

The settings are required for Security Token Service to map the token to a requester partner entry by matching the Subject DN of the certificate to a Requester Partner that has a match on SSL Client Cert DN Identification attribute.

The required settings are:

- Map Token to Partner
- Disable Simple User Mapping
- Disable Attribute Based User Mapping
- Enable Simple Partner Mapping

**Figure 45-11 Token Mapping: x509-wss-validation-template**

**x509-wss-validation-template** Token Validation Template Apply Reset

STS\_VALIDATION\_EDIT\_INSTRUCTIONS

General **Token Mapping**

Map Token To: Map token to Partner

Enable Simple User Mapping

User Token Attribute: Common Name

Datastore Attribute: cn

Enable Attribute Based User Mapping

Enable Simple Partner Mapping

Partner Token Attribute: Subject DN

Partner Datastore Attribute: SSL Client Certificate Distinguished Name

Not all elements apply to all token types and token protocols. The elements that you must define varies.

[Table 45-11](#) describes the token mapping elements for validation templates.

**Table 45-11 New Validation Template: Token Mapping**

Element	Description
Map Token to	<p>WS-Security Validation Template: Map Token to list</p> <ul style="list-style-type: none"> <li>• &lt;empty&gt;: no token mapping operation will occur</li> <li>• Map token to Partner: The token will be mapped to a requester partner</li> <li>• Map Token to User and map binding data to Partner: The token will be mapped to a user, and binding data (such as SSL Client Cert DN or HTTP Basic Auth Username) will be used to map the HTTP request to a requester partner</li> <li>• Map token to User: The token will be mapped to a user</li> </ul> <p>-----</p> <p>WS-Trust Validation Template: Map Token to User</p> <p>Check the box to enable (or clear the checkbox to disable).</p>

**Table 45-11 (Cont.) New Validation Template: Token Mapping**

Element	Description
Enable Simple User Mapping	<p data-bbox="680 327 1446 422">Simple user mapping consists of mapping the incoming token to a user record by using a single token attribute and matching it against a single user record attribute.</p> <p data-bbox="680 432 1446 495">WS-Security Validation Template: Only Username, SAML Assertion, Kerberos, and X.509.</p> <p data-bbox="680 506 1446 600">WS-Trust Validation Template: Username, SAML Assertion, Kerberos, X.509, OAM and custom token. The layout is different, depending on the token type of this validation template:</p> <p data-bbox="680 611 873 636">Username Token:</p> <ul data-bbox="688 646 1438 709" style="list-style-type: none"> <li data-bbox="688 646 1438 709">• Datastore attribute references the user record attribute that will be matched against the username element of the username token.</li> </ul> <p data-bbox="680 720 873 745">SAML Assertion:</p> <ul data-bbox="688 756 1455 909" style="list-style-type: none"> <li data-bbox="688 756 1455 909">• User Token attribute references an attribute from the incoming token that will be matched against the Datastore attribute (defined below) of a user record. The values can be STS_SUBJECT_ID for the NameID Value, or the name of an Attribute contained in the Assertion's AttributeStatement.</li> </ul> <p data-bbox="680 919 1446 1014">In the Token Mapping section of a SAML Validation template, the User Token Attribute will either be the NameID selected from the drop down or a SAML Attribute name entered in the text field.</p> <ul data-bbox="688 1024 1438 1087" style="list-style-type: none"> <li data-bbox="688 1024 1438 1087">• Datastore attribute references the user record attribute that will be matched against the User token attribute referenced above.</li> </ul> <p data-bbox="680 1098 1446 1192">In the Token Mapping section of a SAML Validation template, the Datastore Attribute is the name of the directory attribute that will be used for the LDAP matching query.</p> <p data-bbox="680 1203 792 1228">Kerberos:</p> <ul data-bbox="688 1239 1446 1486" style="list-style-type: none"> <li data-bbox="688 1239 1446 1423">• User Token attribute references an attribute from the incoming token that will be matched against the Datastore attribute (defined below) of a user record. The User Token Attribute can be specified by selecting one of the pre-populated attribute (Kerberos Principal, Kerberos Principal Primary or Kerberos Principal No Domain) or by entering a specific value.</li> <li data-bbox="688 1434 1438 1486">• Datastore attribute references the user record attribute that will be matched against the User token attribute referenced above.</li> </ul> <p data-bbox="680 1497 751 1522">X.509:</p> <ul data-bbox="688 1533 1446 1913" style="list-style-type: none"> <li data-bbox="688 1533 1446 1854">• User Token attribute references an attribute from the incoming token that will be matched against the Datastore attribute (defined below) of a user record. The User Token Attribute can be specified by selecting one of the pre-populated attribute (Subject DN, Common Name, Country Name, State or Province Name, Locality Name, Organizational Name, Organizational Unit Name or Domain Component) or by entering a specific value (which can be set to STS_X509_### by replacing ### with the upper case X.500 component name, for example STS_X509_CN to reference the common name component of the certificate subject).</li> <li data-bbox="688 1864 1438 1913">• Datastore attribute references the user record attribute that will be matched against the User token attribute referenced above.</li> </ul>

**Table 45-11 (Cont.) New Validation Template: Token Mapping**

Element	Description
	<p>OAM:</p> <ul style="list-style-type: none"> <li>• Datastore attribute references the user record attribute that will be matched against the username element of the username token. Should be the user ID attribute defined in the Default User Identity Store.</li> </ul> <p>Custom:</p> <ul style="list-style-type: none"> <li>• User Token attribute references an attribute from the incoming token that will be matched against the Datastore attribute (defined below) of a user record. The possible values are the names of the attribute returned by the custom token validation module.</li> <li>• Datastore attribute references the user record attribute that will be matched against the User token attribute referenced above.</li> </ul>
<p>Enable User Name Identifier Mapping</p>	<p>When enabled, define the following:</p> <p>WSS and WS-Trust Validation Templates will contain the same section for the Name Identifier mapping settings.</p> <p>A NameID user mapping operation consists of mapping the incoming SAML Assertion to a user record by mapping the NameID Value to a single user record attribute, based on the NameID format</p> <p>When enabled, Security Token Service evaluates the NameID format, and based on the Name Identifier mapping table which user record attribute should be matched against the Name ID value contained in the Assertion. The Name Identifier mapping table holds the user record attributes to be used for the mapping operation. It contains standard NameID formats, but it can be customized to define custom Name ID formats.</p> <p>To add custom NameID format, click the add button on the Name Identifier mapping table, and enter the custom URI.</p> <p>To set an attribute for a specific NameID format to be used for mapping operation, set the user record attribute on the line for that format.</p>

**Table 45-11 (Cont.) New Validation Template: Token Mapping**

Element	Description
Enable Attribute Based User Mapping	<p data-bbox="678 327 1446 386">WSS Validation Template: only Username, SAML Assertion, Kerberos and X.509.</p> <p data-bbox="678 401 1446 459">WS-Trust Validation Template: only Username, SAML Assertion, Kerberos, X.509 and custom token</p> <p data-bbox="678 474 1446 688">An Attribute Based User Mapping operation consists of mapping the incoming token to a user record by using an LDAP query and token attributes. The format of the LDAP query defines the mapping rule and specifies the token attributes to be used by their names, surrounded by the percent (%) character. For example, an LDAP query that will map a token based on two token attributes (firstname and lastname) would be (&amp;(sn=%lastname)(givenname=%firstname%)).</p> <p data-bbox="678 703 1446 730">The possible token attributes depend on the token type.</p> <p data-bbox="678 745 1446 772">Username Token</p> <ul data-bbox="690 787 1446 846" style="list-style-type: none"> <li>• STS_SUBJECT_ID is the only available token attribute containing the username element of the Username token.</li> </ul> <p data-bbox="678 856 1446 884">SAML Assertion</p> <ul data-bbox="690 898 1446 1094" style="list-style-type: none"> <li>• STS_SUBJECT_ID contains the NameID Value.</li> <li>• STS_NAMEID_FORMAT contains the NameID Format</li> <li>• STS_NAMEID_QUALIFIER contains the NameID Qualifier</li> <li>• STS_SAML_ASSERTION_ISSUER contains the Issuer of the Assertion</li> <li>• Attributes present in the Assertion's AttributeStatement</li> </ul> <p data-bbox="678 1104 1446 1131">Kerberos</p> <ul data-bbox="690 1146 1446 1341" style="list-style-type: none"> <li>• STS_KERBEROS_PRINCIPAL_SHORT contains the Kerberos Principal attribute.</li> <li>• STS_KERBEROS_PRINCIPAL_FULL contains the Kerberos Principal Primary attribute</li> <li>• STS_KERBEROS_PRINCIPAL_NODOMAIN contains the Kerberos Principal No Domain attribute</li> </ul> <p data-bbox="678 1352 1446 1379">X.509</p> <ul data-bbox="690 1394 1446 1661" style="list-style-type: none"> <li>• STS_SUBJECT_ID contains the Subject DN.</li> <li>• STS_X509_CN contains the Common Name</li> <li>• STS_X509_C contains the Country Name</li> <li>• STS_X509_ST contains the State or Province Name</li> <li>• STS_X509_L contains the Locality Name</li> <li>• STS_X509_O contains the Organizational Name</li> <li>• STS_X509_OU contains the Organizational Unit Name</li> <li>• STS_X509_DC contains the Domain Component</li> </ul> <p data-bbox="678 1671 1446 1698">Custom Token</p> <ul data-bbox="690 1713 1446 1772" style="list-style-type: none"> <li>• The possible values are the names of the attribute returned by the custom token validation module.</li> </ul>

**Table 45-11 (Cont.) New Validation Template: Token Mapping**

Element	Description
Enable Simple Partner Mapping	<p data-bbox="602 327 1341 390">Only for WSS Validation Template and for the following token types: Username, SAML Assertion, Kerberos, and X.509.</p> <p data-bbox="602 401 1360 491">A simple partner mapping operation consists of mapping the incoming token to a partner requester by using a single token attribute and matching it against a partner identification attributes.</p> <p data-bbox="602 501 1344 564">The layout is different, depending on the token type of this validation template</p> <p data-bbox="602 575 789 600">Username Token</p> <ul data-bbox="602 611 1360 701" style="list-style-type: none"> <li>• Partner Datastore attribute references the partner identification attribute that will be matched against the username element of the username token.</li> </ul> <p data-bbox="602 711 784 737">SAML Assertion</p> <ul data-bbox="602 747 1352 1005" style="list-style-type: none"> <li>• Partner Token attribute references an attribute from the incoming token that will be matched against the Partner Datastore attribute (defined below) of a Requester Partner. The values can be STS_SUBJECT_ID for the NameID Value, or the name of an Attribute contained in the Assertion's AttributeStatement.</li> <li>• Partner Datastore attribute references the partner identification attribute that will be matched against the Partner token attribute referenced above</li> </ul> <p data-bbox="602 1016 704 1041">Kerberos</p> <ul data-bbox="602 1052 1373 1339" style="list-style-type: none"> <li>• Partner Token attribute references an attribute from the incoming token that will be matched against the Partner Datastore attribute (defined below) of a requester partner. The Partner Token Attribute can be specified by selecting one of the pre-populated attribute (Kerberos Principal, Kerberos Principal Primary or Kerberos Principal No Domain) or by entering a specific value.</li> <li>• Partner Datastore attribute references the partner identification attribute that will be matched against the Partner token attribute referenced above</li> </ul> <p data-bbox="602 1350 667 1375">X.509</p> <ul data-bbox="602 1386 1373 1797" style="list-style-type: none"> <li>• Partner Token attribute references an attribute from the incoming token that will be matched against the Partner Datastore attribute (defined below) of a requester partner. The Partner Token Attribute can be specified by selecting one of the pre-populated attribute (Subject DN, Common Name, Country Name, State or Province Name, Locality Name, Organizational Name, Organizational Unit Name or Domain Component) or by entering a specific value (which can be set to STS_X509_### by replacing ### with the upper case X.500 component name, for example STS_X509_CN to reference the common name component of the certificate subject).</li> <li>• Partner Datastore attribute references the partner identification attribute that will be matched against the Partner token attribute referenced above.</li> </ul>



**Table 45-11 (Cont.) New Validation Template: Token Mapping**

Element	Description
Enable Partner Name Identifier Mapping	<p>When enabled, defines the following only for WSS Validation Template and for SAML token types:</p> <p>A NameID user mapping operation consists of mapping the incoming SAML Assertion to a user record by mapping the NameID Value to a single requester partner identification attribute, based on the NameID format.</p> <p>When enabled, Security Token Service will evaluate the NameID format, and based on the Name Identifier mapping table which partner identification attribute should be matched against the Name ID value contained in the Assertion. The Name Identifier mapping table holds the requester partner identification attributes to be used for the mapping operation. It contains standard NameID formats, but it can be customized to define custom Name ID formats.</p> <p>To add custom NameID format, click the Add button on the Name Identifier mapping table, and enter the custom URI.</p> <p>To set an attribute for a specific NameID format to be used for mapping operation, set the requester partner identification attribute on the line for that format.</p>

## 45.4.2 Managing Token Validation Templates

Users with valid Administrator credentials can add, find, edit, or delete token validation templates.

This is a server side configuration. A default Token Validation Template exists. Skip any steps that you do not need. The Security Token Service Endpoint must be linked to a WS Security Validation Template that indicates:

- how to validate the token in the Webservice Security header
- how to map the token and binding data to a Requester

The information here can be applied when you want to validate the following:

- WS-Security tokens present in the SOAP Header, of type: Username, SAML 1.1, SAML 2.0, X.509 and Kerberos.
- WS-Trust tokens present in the OnBehalfOf element or in the ValidateTarget element of the WS-Trust request, of type: Username, SAML 1.1, SAML 2.0, X.509, Kerberos, OAM Session Propagation Token and custom tokens.

The following procedure includes several examples of input following specific parameters. Also, a brief translation appears within parentheses (). For instance: Name (username-token): email-wstrust-valid-temp. Values in your environment will be different.

---

---

**See Also:**

- ["About Managing Token Validation Templates"](#)
  - ["Searching for an Existing Template"](#)
- 
- 

To manage token validation templates:

1. Locate and open the desired Token Validation Template.  
See ["Searching For a Template"](#).
2. **New Token Validation Template:**
  - a. Click the **New Validation Template** button in the upper-right corner (or click the **Add (+)** command button above the Search Results table).
  - b. **General:** Define parameters for this template ([Table 45-9](#)). For example:  
Name (username-token): `email-wstrust-valid-temp`  
Token Protocol (WS-Security for token protocol): Webservice  
Token Type (username): `email`  
Default Partner Profile: `requester-profile`
  - c. **Authentication:** Enable Credential Validation for this template, if needed, and provide details ([Table 45-10](#)). If the token type is username, enable credential validation if needed for this template and provide the details.
  - d. **Token Mapping:** Specify preferences for this template based on your token type ([Table 45-11](#)).
  - e. Click Save and dismiss the confirmation window (or click Cancel without saving it).
  - f. Close the definition (or edit it as described in Step 4).
3. **Edit a Template:** Start with the saved page you just created.
  - a. Edit the template definition as needed.
  - b. Click the **Apply** button at the top of the page to submit changes (or click Revert to undo your changes).
4. **Remove a Token Validation Template:**
  - a. Click the desired name in the Search Results table to select the item to remove.
  - b. From the **Actions** menu, click **Delete** (or click the **Delete (X)** command button above the table).
  - c. Click the **Delete** button in the Confirmation window (or click **No** to cancel the operation).

## 45.5 Managing Security Token Service Endpoints

An endpoint is a Web Service published by Security Token Service where clients can send WS-Trust requests over SOAP.

An endpoint is:

- Protected by a WS Security Policy.
- Bound to WSS Validation Template that will indicate how to validate the security token and how to map it.
- Specific to a token type, namely, the one specified in the WSS Validation Template.

---



---

**Note:**

The WS-Security policy protecting the endpoint must be compatible with the WSS Validation Template bound to the endpoint.

---



---

An endpoint is a Web Service endpoint published by Security Token Service and protected by OWSM Agent. An endpoint is bound to:

- A WS-Security policy that will determine the WSS requirements in terms of message protection and security tokens
- A WSS Validation template that will indicate how the request will be processed, how the security token will be validated.

This section provides the following information:

- [About Managing Endpoints](#)
- [Managing EndPoints](#)

### 45.5.1 About Managing Endpoints

An endpoint is a Web Service endpoint published by Security Token Service and protected by OWSM Agent.

Security Token Service Endpoint definitions consist of three categories, as shown in [Figure 45-12](#).

**Figure 45-12 Endpoints Page**

Endpoints Apply Revert

Row	Endpoint URI	Policy URI	Validation Template
1	/wss11user	sts/wss11_username_token_with_message_protection_service_policy	username-wss-valida
2	/wss11x509	sts/wss11_x509_token_with_message_protection_service_policy	x509-wss-validation-template
3	/wss10x509	sts/wss10_x509_token_with_message_protection_service_policy	x509-wss-validation-template
4	/wss10user	sts/wss10_username_token_with_message_protection_service_policy	username-wss-validation-template

[Table 45-12](#) describes the required Endpoints categories.

**Table 45-12 Endpoints Page**

Elements	Description
Endpoint URI	The path to the Endpoint, relative to the Security Token Service base URL. The Security Token Service base URL is /sts.
Policy URI	<p>Choose from a listing of Oracle WSM policies the one used to protect this Endpoint.</p> <p>Oracle Access Management Administrators can add a new custom policy to the available listing. To show this newly created Policy URI in the endpoints table list, use the following wlst command to update the owspolicies map:</p> <pre>putStringProperty("/stsglobal/owspolicies/&lt;index&gt;", "&lt;newcustom_policypath&gt;")</pre> <p>For example:</p> <pre>putStringProperty("/stsglobal/owspolicies/31", "sts/newcustom_policy")</pre>
Validation Template ID	Choose from a listing of Validation Template names to identify one for use with this Endpoint.

Once an Endpoint is created, you can remove it but you cannot edit the definition.

## 45.5.2 Managing EndPoints

Users with valid Oracle Access Management Administrator credentials can add, edit, or remove an Endpoint.

### Prerequisites

#### Creating a Validation Template

To create or delete an endpoint:

1. In the Oracle Access Management Console, click **Federation** at the top of the window.
2. In the Federation console, select **Endpoints** from the **View** menu in the **Security Token Service** section.
3. **New Endpoint:** see [Table 45-12](#) and
  - a. Click the **Add (+)** button above the table (or choose **New Endpoint** from the **Actions** menu).
  - b. Enter the new Endpoint URI.
  - c. Choose one of the Oracle WSM policies to protect this Endpoint.
  - d. Choose the Validation Template to use with this Endpoint.
  - e. Click **Apply** to submit the definition and dismiss the confirmation window (or click **Revert** to dismiss the page without submitting it).
  - f. Close the page.

#### 4. Remove Endpoint:

- a. Highlight a row in the Endpoints table and click the **Delete (X)** button (or choose Delete Selected from the Actions menu).
- b. Confirm removal (or cancel the removal).

## 45.6 Managing Token Issuance Policies, Conditions, and Rules

Token issuance policy includes the following topics:

- [About Token Issuance Policies](#)
- [About Managing Token Issuance Conditions and Rules](#)
- [Managing Token Issuance Policies and Conditions](#)

### 45.6.1 About Token Issuance Policies

A Token Issuance Policy defines the rules under which a token can be issued for a resource (Relying Party Partner) based on the client's identity, with the client either being a Requester Partner or an end user.

If a Requester is NOT present, it is assumed that the User (represented by the on-behalf-of (OBO) token or WSS Token) is trying to access the RelyingParty.

When issuing a token, Security Token Service will determine for which Relying Party that token is created, and it will then evaluate if the client is authorized to request the token for that Relying Party. In order to issue a token, a Token Issuance Policy must be created with the resource involved in the operation, and with possibly a condition. At runtime if the policy evaluation is successful, the token will be issued.

You can add Conditions, Rules, and Responses to this Token Issuance Policy.

### 45.6.2 About Managing Token Issuance Conditions and Rules

The Token Issuance Policy allows the Administrator to define conditions along with "Allow" and "Deny" rules for the policy.

Each Token Issuance Policy can contain one or more conditions, and rules that determine whether access to the requested resource should be granted or denied:

- An Allow type rule specifies who is authorized to access a protected resource.  
Only partners and users listed in the Condition are granted access; everyone else is denied access to the resource.
- A Deny type rule specifies explicitly who is denied access to the protected resource.

Only partners and users listed in the Condition are denied access; everyone else is granted access to the resource.

---

---

**Note:**

When adding User conditions, the identity store from which the users are to be chosen can be selected from a list. Ensure that you choose the Default User Identity Store, which is the only one used by Security Token Service.

---

---

Managing Token Issuance Conditions is similar to managing Authorization Conditions and Rules.

See [Figure 45-4](#) shows the Conditions tab of a Token Issuance Policy.

**Figure 45-13** *Token Issuance Policies and Conditions*

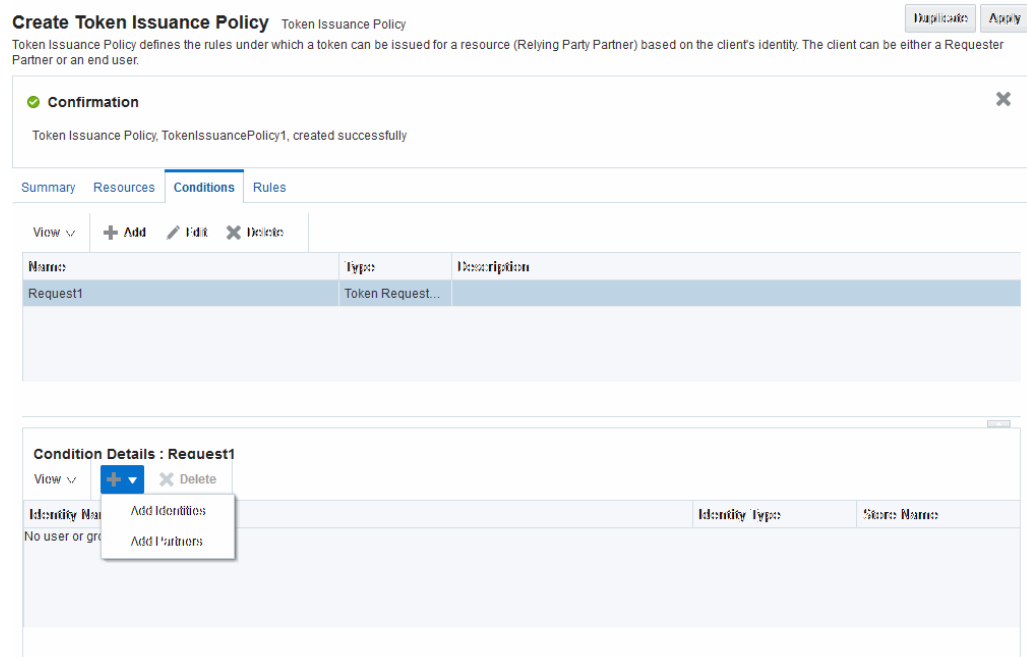

[Table 45-13](#) describes the Token Issuance Condition requirements.

**See Also:**

[Managing Oracle Access Management Mobile and Social](#) for details about Adding a Token Issuance Policy for Mobile and Social Authentication Service

**Table 45-13** *Conditions tab: Token Issuance Policy*

Element	Description
<b>Summary tab</b>	
Name	A unique name for this Token Issuance Policy.
Description	Optional.
<b>Conditions tab</b>	
Class	<a href="#">Table 25-11</a> describes elements and controls on the Conditions tab.
<b>Rules tab</b>	
	<a href="#">Table 25-22</a> describes the elements and controls on the Rules tab for Simple Mode evaluations.
	<a href="#">Table 25-23</a> describes the elements on the Rule tab in Expression mode.

**Table 45-13 (Cont.) Conditions tab: Token Issuance Policy**

Element	Description
<b>Condition Details</b>	
Add	Choose from the following populations: <ul style="list-style-type: none"> <li>• Add Identities: This choice opens a Search window where you can set the Store Name, Choose an Entity Type (All, User, or Group), and Provide an Entity Name. You then choose one or more results from those listed and click Add Selected to populate the condition.</li> <li>• Add Partners: This choice opens a Search window where you can locate specific partners to populate the condition. Enter your search criteria (or click the arrow key beside the field to find all partners), then choose one or more results and click Add Selected to populate the condition.</li> </ul>
Entity Name	The name of the User or Group, as defined in the selected User Identity Store.
Entity Type	The type of entity you want to locate during a search to add identifies to the condition: User, or Group.
Store Name	Choose the name of the User Identity Store to search for users or groups to populate the condition. Remember, Security Token Service uses only the Default Identity Store.

### 45.6.3 Managing Token Issuance Policies and Conditions

Users with valid Administrator credentials can add a Token Issuance Policy and Conditions to an Application Domain.

When you add resources to this policy, you may want to add the UnknownRP and MissingRP resources.

You need to meet the following prerequisites and perform the following task:

- [Prerequisites for Managing Token Issuance Policies and Conditions](#)
- [Managing Token Issuance Policies and Conditions](#)

#### 45.6.3.1 Prerequisites for Managing Token Issuance Policies and Conditions

You must have already configured the Application Domain before you start to add a Token Issuance policy.

---



---

**Note:**

You can add Token Issuance Policies to the IAM Suite Application Domain.

---



---

#### 45.6.3.2 Managing Token Issuance Policies and Conditions

After creating a Token Issuance Policy, you can add resources, conditions, condition details, and rules to the policy.

To manage Token Issuance policies and conditions:

1. Locate the desired domain.  
See [Searching for an Existing Application Domain](#).
2. On the individual Application Domain page, select the **Token Issuance Policies** tab.
3. **Create a Token Issuance Policy:**
  - a. In the desired domain, click the Token Issuance Policies tab and then click the **Create Token Issuance Policy** button to open a fresh page.
  - b. On the **Summary** page, enter a unique name and optional description.
4. **Add Resources:** This step presumes that the resource has been defined in the Application Domain and is ready to be added to policies.
  - a. Click the **Resources** tab.
  - b. Click **Add (+)**.
  - c. Click the **Search** button to display a list of defined resources you can add.
  - d. Click the desired resource in the results table, then click **Add Selected**.
  - e. Repeat as needed to add any other resources to this policy.
5. **Add Conditions to a Policy:** The only types available are **Token Requester Identity** or **True**.
  - a. Click the **Conditions** tab, then click the **Add** button on the **Conditions** tab to display the Add Condition window.
  - b. Enter a unique name for this condition in the dialog box.
  - c. Choose **Token Requester Identity** from the **Type** list.
  - d. Click **Add Selected**.
  - e. Proceed with Step 5 to add details for Token Requestor Identity. Otherwise, skip to Step 6.
6. **Add Conditions Details:**
  - a. Click the **Condition** name to display Conditions: Details.
  - b. From the **Selected Identities** table, click the **Add** button and choose either:  
**Add Partners:** In the Search field, enter criteria (or click the arrow key beside the field to find all partners); click one or more results then click **Add Selected** to populate the condition.  
**Add Identities:** Select the Store Name, select the desired Identity Type, enter search criteria and click the Search button; choose one or more results and click **Add Selected** to populate the condition.
  - c. Click the **Save** button on the Condition Details panel.
7. **Add Rules:** Perform these steps to Allow or Deny access based on your Conditions.
  - a. Click the **Rules** tab.



- b. Check the **Rule Mode**: Simple or Expression.
  - c. **Expression Mode**: Build your expression by entering operators and choosing and inserting conditions..  
See [Table 25-24](#).  
See [Table 25-23](#).
  - d. **Simple Mode**: Click to **Match** either All or Any of the selected conditions, then using arrows for Allow (or Deny) Rule, move desired conditions from the Available Conditions column into the Selected Conditions column.
8. Click **Apply** and then close the Confirmation window.
  9. **Find (or Add) TokenServiceRP Resources in the Application Domain**:  
See [Managing TokenServiceRP Type Resources](#).

## 45.7 Managing TokenServiceRP Type Resources

A Security Token Service Relying Party Partner defined in the Security Token Service Partner Store is represented by the resource of type TokenServiceRP.

A Token Issuance Policy defines the rules under which a token can be issued for a resource (Relying Party Partner) based on the client's identity, with the client either being a Requester Partner or an end user. When issuing a token, Security Token Service will determine for which Relying Party that token is created, and it will then evaluate if the client is authorized to request the token for that Relying Party.

---



---

**Note:**

To issue a token, a Token Issuance Policy must be created with the resource involved in the operation and, possibly, with a condition. At run time if the policy evaluation is successful, the token will be issued.

---



---

The resource(s) in a policy can be:

- A TokenServiceRP type resource represents resources for, and is based on, the Token Service Relying Party (required for Mobile and Social REST clients).

---



---

**See Also:**

[Managing Oracle Access Management Mobile and Social](#) for details about Configuring Access Manager for Mobile and Social Authentication Service

---



---

- The pre-existing UnknownRP resource which is needed when Security Token Service is not able to map the Service URL referenced in the `AppliesTo` element of the WS-Trust request to an Security Token Service Relying Party Partner entry.
- The pre-existing MissingRP resource which is needed when the `AppliesTo` element of the WS-Trust request is missing.

**Note:**

Both the MissingRP and UnknownRP are defined in the IAM Suite Application Domain.

A resource of type TokenServiceRP, [Figure 45-14](#), represents a Security Token Service Relying Party Partner defined in the Security Token Service Partner Store.

**Figure 45-14 Pre-defined Resource Type: TokenServiceRP**



Resources of type TokenServiceRP are used in Token Issuance Policies, which are evaluated when Security Token Service issues tokens at run time. This is a predefined resource type, which cannot be deleted. However, additional operations can be created, edited or deleted as needed. Predefined operations are shown with a lock icon.

See the following topics for more information:

- [About Managing TokenServiceRP Type Resources in Access Manager](#)
- [Managing TokenServiceRP Type Resources in Application Domains](#)

### 45.7.1 About Managing TokenServiceRP Type Resources in Access Manager

All the resources of a specific type in a domain and the resources provided out of the box can be filtered when the search criteria used is TokenServiceRP Type Resources.

You need to use the Search controls for the Application Domain to locate resources of a specific type in a domain. Resource Type TokenServiceRP is the search criteria. The Search Results table lists all resources of this type in the Application Domain.

[Figure 45-15](#) shows the search controls for the IAM Suite resources.

**Figure 45-15 Search: Resource Type TokenServiceRP in Application Domain**

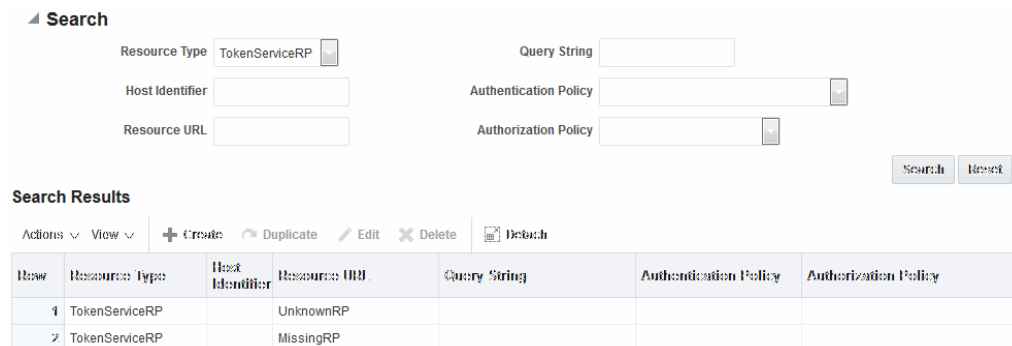

The TokenServiceRP resources in this domain include those provided out of the box, and described earlier:

- UnknownRP resource
- MissingRP resource

## 45.7.2 Managing TokenServiceRP Type Resources in Application Domains

Users with valid Administrator credentials can add TokenServiceRP resources to an Application Domain.

---

---

**Note:**

- If `AppliesTo` is present in the RST but the requester could not be mapped, use the `TokenServiceRP:UnknownRP` resource.
  - If `AppliesTo` is not present, use `TokenServiceRP:MissingRP`, otherwise select the appropriate resource.
- 
- 

See [About Managing TokenServiceRP Type Resources in Access Manager](#).

To manage TokenServiceRP Resources:

1. Locate the desired Application Domain.  
See [Searching for an Existing Application Domain](#).
2. **Add TokenServiceRP Resource to the Application Domain:**
  - a. Click the **New Resource** button on the Application Domain Search page.
  - b. Specify the **Resource Type** as **TokenServiceRP**.
  - c. Enter a Resource URL that is the Relying Party ID for whom the token issuance policy will be defined.
  - d. Click the **Apply** button at the top of the page to submit this and dismiss the confirmation window.  
See [Defining Resources in an Application Domain](#).
3. **Find TokenServiceRP Resources:**
  - a. In the desired Application Domain, open the Resources tab to display the Search controls.
  - b. From the **Resource Type**, choose **TokenServiceRP**, and click **Search**.
  - c. Review the Search Results table and click a name to open the Resource Definition.

## 45.8 Making Custom Classes Available

When Security Token Service does not support the token that you want to validate or issue out-of-the-box, a developer can write custom validation and issuance module classes.

You can apply the information when you have:

- WS-Security User Name Token
- WS-Trust Custom Token
- Issuing Custom Token

---



---

**Note:**

You can also write a script that includes WebLogic Scripting Tool commands for any operation that you can accomplish through the console. For more information, see *WLST Command Reference for WebLogic Server*.

---



---

The following topics provide information about:

- [About Making Classes Available](#)
- [About Narrowing a Search for Custom Tokens](#)
- [Managing Custom Tokens](#)

## 45.8.1 About Making Classes Available

After writing the custom token validation and/or issuance classes, you must add Custom Token Configuration to Security Token Service to indicate when and how these classes should be used.

On the New Custom Token page only the Token Type Name is required (identified with an asterisk, \*). See [Figure 45-16](#).

Not all elements apply to all custom tokens. However, if you submit information that is incomplete, a dialog box appears to identify what is missing.

**Figure 45-16 New Custom Token Page**

For the custom token, you must decide on the XML Element Name, XML Element Namespace, Binary Security Token Type, and so on. [Table 45-14](#) describes the elements on a Custom Token page based on the examples.

**Table 45-14 New Custom Token Elements**

Element	Description
Token Type Name	<p>The unique name you choose for this custom token. For example:</p> <pre>email_token</pre> <p>Note: After you save a new custom token configuration, you cannot edit this name.</p>
Default Token URI	<p>The URI for this custom token. This URI can then be used in the RST to request that a custom token of this type should be issued. For the example in this chapter, the value would be:</p> <pre>oracle.security.fed.sts.customtoken.email</pre>
XML Element Name	<p>The name you decide on, which will be associated with the Token Type Name. For example:</p> <pre>email</pre> <p>If you specify <code>email</code> as the XML Element Name, each time the element name, <code>email</code>, appears in an incoming token it will be associated with the Token Type Name (in this case <code>email_token</code>).</p> <p>Note: Minimally, you need either an XML Element Name or Binary Security Token Type.</p>
Validation Classname	<p>The name of the custom token validation class that you made available to Security Token Service. For example:</p> <pre>oracle.security.fed.sts.tpe.providers.email.EmailTokenValidatorModuleImpl</pre> <p>Note: Minimally, you need either an issuance class name or validation class name, depending on whether you want to issue or validate a custom token.</p>
XML Element Namespace	<p>The namespace of the custom token element name. For example:</p> <pre>http://email.example.com</pre>
Issuance Classname	<p>The name of the custom token issuance class that you made available to Security Token Service. For example:</p> <pre>oracle.security.fed.sts.tpe.providers.email.EmailTokenIssuerModuleImpl</pre> <p>Note: Minimally, you need either an Issuance classname or Validation classname, depending on whether you want to issue or validate a custom token.</p>

**Table 45-14 (Cont.) New Custom Token Elements**

Element	Description
Binary Security Token Type	<p>Enables the class to validate a custom token sent in as a <code>BinarySecurityToken</code>.</p> <p>The <code>ValueType</code> of the <code>BinarySecurityToken</code> for this custom token. If Security Token Service receives a Binary Security Token with this <code>ValueType</code>, it will be forwarded to this custom token's Validation class for validation.</p>
Validation Attributes	<p>This section enables you to add (or remove) validation attributes. The table displays existing validation attributes, if any. For this example:</p> <ul style="list-style-type: none"> <li>Attribute Name: <code>testsetting</code></li> <li>Attribute Type: <code>String</code></li> </ul> <p>Note: You will add a value to the attribute when creating a Token Validation Template.</p>
Issuance Attributes	<p>This section enables you to add (or remove) issuance attributes. The table displays the following information for existing issuance attributes.</p> <ul style="list-style-type: none"> <li>Attribute Name: <code>testsetting</code></li> <li>Attribute Type: <code>String</code></li> </ul> <p>Note: You will add a value to the attribute when creating a Token Issuance Template.</p>
Save	Click this button on the New Custom Tokens page to save your configuration information.
Cancel	Click this button to dismiss your configuration details.
Apply	Click this button to submit your changes.
Revert	Click this button to dismiss your changes.

#### 45.8.1.1 Task Overview: Adding Custom Tokens for Custom Classes

You can add custom tokens for custom classes.

To add custom tokens:

1. Create a JAR file containing only your custom `TokenIssuerModule` or `TokenValidatorModule` classes (or both). No XML metadata or manifest is needed.
2. Review information in [Table 45-14](#).
3. Add the JAR to the OAM Server hosting Security Token Service and create a new custom token, as described in [Managing Custom Tokens](#).

#### 45.8.2 About Narrowing a Search for Custom Tokens

By default, all currently defined custom tokens are listed in the Search Results table. In custom token searches, wild cards are not allowed.

[Figure 45-17](#) illustrates the Custom Tokens Search controls and Results table. These appear when you double-click the Custom Tokens node in the navigation tree.

**Figure 45-17 Custom Tokens Search Page and Controls**

**Custom Tokens** + New Custom Token

Use the search tool to find custom tokens or click the New custom token button to create a new custom token

**Search**

Default Token URI

**Search Results**

Actions ▾ View ▾

Row	Token Type Name	XML Element Name	XML Element Namespace	Binary Security Token Type	Default Token URI	Validation Classname	Issuance Classname
No data to display							

Table 45-15 describes the Custom Tokens Search elements and controls. No wild cards (\*) are allowed in Custom Token searches.

**Table 45-15 Custom Tokens Search Elements and Controls**

Element	Description
Default Token URI	The URI that was defined for the custom token. You can enter the entire URI or only part of it. For instance, if you enter "ai" the Search Results table will display all custom tokens defined with a token URI that includes the letters "ai". Note: Wild cards are not allowed in Custom Token searches.
Search	Initiates the Search function using criteria provided in the form.
Reset	Resets the Search form with defaults only.
Search Results	Provides the results of your search based on your choices in the View menu.
Actions menu	Provides the following functions that can be performed on a selection in the results table: Note: Actions menu functions mirror command buttons above the results table. For example: <ul style="list-style-type: none"> <li>• <b>New Custom Token:</b> Click the New Custom Token button at the top of the Search page, or select New Custom Token from the menu, or click the + button above the table.</li> <li>• <b>Edit:</b> Double-click a name in the Token Type Name column of the Search Results table, or select Edit from the Actions menu, or click the Edit (pencil icon) command button above the Results Table.</li> <li>• <b>Create Like:</b> Select the desired row in the table and either select Create Like from the Actions menu, or click the Create Like command button above the table</li> <li>• <b>Remove:</b> Select the desired row in the table and either select Delete from the Actions menu, or click the Delete (X) command button above the table.</li> </ul>
View menu	Provides functions you can use to display various information in the results table:
Up-Down Arrows	Controls affecting the ordering of items listed in the results table: <ul style="list-style-type: none"> <li>• Ascending</li> <li>• Descending</li> </ul>

## 45.8.3 Managing Custom Tokens

Users with valid Administrator credentials can manage custom tokens for custom Token Module classes.

The following procedure includes steps to add, edit, and delete custom tokens or attributes of a custom token. Skip any steps that you do not need.

### 45.8.3.1 Prerequisites for Managing Custom Tokens

See the developer creating the custom tokens and the *Oracle Fusion Middleware Developer's Guide for Oracle Access Management* for details about Writing a TokenIssuanceModule Class:

See "[Making Custom Classes Available](#)".

See "[About Narrowing a Search for Custom Tokens](#)".

### 45.8.3.2 Making Custom Classes Available

You can create a new Custom Token, find it and edit its configuration. From the Search Results table, you can delete a particular custom token.

To make custom classes available:

1. Create and add the JAR containing your Issuance and Validation classes to the OAM Server hosting Security Token Service using one of these methods:
  - Add the custom token jar and the sts-common.jar that is available in `$DOMAIN_HOME/config/fmwconfig/mbeans/oam` to the Managed Server classpath by editing the startup script.
  - Add the custom token jar and the sts-common.jar that is available in `$DOMAIN_HOME/config/fmwconfig/mbeans/oam` to the `$DOMAIN_HOME/lib` directory to automatically add these jars to the Managed Server classpath.
  - Restart the OAM Server.
2. **New Custom Token:**
  - a. In the Oracle Access Management Console, click **Federation** at the top of the window.
  - b. Select **Create Custom Token** from the **Create (+)** drop-down menu in the Security Token Service section.
  - c. Fill in the New Custom Token page with details for your custom classes. See [Table 45-14](#).
  - d. Click **Save** and dismiss the confirmation window (or click **Cancel** to dismiss the page without submitting it).
  - e. Close the page (or edit as described in Step 4).
  - f. Proceed to Step 4, if needed, or go to the following topic:  
See "[Managing a Custom Security Token Service Configuration](#)".



3. **Find Custom Tokens:** In the **Federation** console, select **Custom Tokens** from the **View** menu in the **Security Token Service** section.
  - a. **Find All:** Click the Search button and view the results table with all custom tokens listed.
  - b. **Narrow the Search:** Enter some or all characters in the desired Default Token URI, click the **Search** Button, and review the results table.
  - c. **Reset the Search Form:** Click the Reset button.
4. **Edit Custom Token Configuration:** Start with the saved page you just created.

*Alternatively:* Use Step 3 to find the desired Custom Token, then double-click the name in the Search Results table to open the page.

  - a. In the named Custom Token page, click the appropriate field and edit as needed.
  - b. **Add Attributes:** Click the Add (+) icon for the Attributes table, enter the Attribute Name and an Attribute Type.

See [Table 45-14](#).
  - c. **Remove Attributes:** From the Attributes table, click the row containing the attribute to remove, click the Delete (X) icon for the table, and dismiss the Confirmation window.
  - d. **Apply Changes:** Click the Apply button at the top of the page to submit changes.
5. **Remove a Custom Token:**
  - a. Click the desired name in the Search Results table to select the item to remove.
  - b. From the **Actions** menu, click **Delete** (or click the **Delete (X)** command button above the table).
  - c. Click the **Delete** button in the Confirmation window (or click **No** to cancel the operation).

## 45.9 Managing a Custom Security Token Service Configuration

The following tasks explain how to manage a custom security token service configuration:

- [Creating a Validation Template](#)
- [Creating the Issuance Template for a Custom Token](#)
- [Adding the Custom Token to a Requester Profile](#)
- [Adding a Custom Token to a Relying Party Profile](#)
- [Mapping the Token to a Requestor](#)
- [Creating an /wssuser EndPoint](#)

## 45.9.1 Creating a Validation Template

Users with valid Oracle Access Management Administrator credentials can create a Validation Template with a Token Protocol of Webservice Trust to map the token to the requester.

The template in this example can be used for the module classes described earlier in this chapter. Full implementation details are shown in the following figures. As you review these, notice how specifications for this template reference the module class code:

- [Figure 45-18](#)
- [Figure 45-19](#)

**Figure 45-18 General Details: email-wstrust-valid-temp**

**New Validation Template: General** Token Validation Template

Back Save Cancel Next

General Token Mapping

\* Validation Template Name:

Description:

\* Token Protocol:  WS-Trust  WS-Security

\* Token Type:

▲ Custom Validation Attributes

Row	Custom Token Attribute Name	Attribute Value
1	test	<input type="text" value="hello"/>

**Figure 45-19 Token Mapping: email-wstrust-valid-temp**

**New Validation Template: Token Mapping** Token Validation Template

Back Save Cancel Next

General Token Mapping

Map Token To User

Enable Simple User Mapping

User Token Attribute:

Datastore Attribute:

Enable Attribute Based User Mapping

To create a validation template for custom module classes:

1. In the Oracle Access Management Console, click **Federation** at the top of the window.

2. Select **Create Token Validation Template** from the **Create (+)** drop-down menu in the **Security Token Service** section.
3. **General:** Set the following for use with the custom token.
  - Validation Template Name: email-wstrust-valid-temp
  - Token Protocol: Webservice Trust
  - Token Type: email
  - Default Partner Profile: requester-profile
  - Custom Validation Attributes: test: hello
4. **Token Mapping:** Set the following for use with the custom token in this chapter.
  - Check the box beside Map Token To User (to enable it).
  - Check the box beside Enable Simple User Mapping and enter:
    - User Token Attribute: STS\_SUBJECT\_ID
    - Datastore Attribute: mail
5. Click **Save** and dismiss the confirmation window.
6. Proceed as follows:
  - See [Creating the Issuance Template for a Custom Token](#).

## 45.9.2 Creating the Issuance Template for a Custom Token

Users with valid Oracle Access Management Administrator credentials can create a Token Issuance Template.

This is a server side configuration. Each Token Issuance Template indicates how to construct a token, and which signing or encryption to use when constructing a token. Each Token Issuance Template also defines the attributes to be sent as part of the outbound token for mapping, and filtering data. However, Issuance Templates do not list mapping or filtering rules, which are defined in the Relying Party Partner Profile.

You can use the template in this example for the email custom token as described earlier. Implementation details are shown in the following figures, and described in the accompanying procedure. As you review them, you can review how specifications for this template reference the module class code:

- [Figure 45-20](#)
- [Figure 45-21](#)

**Figure 45-20 General Details: email-issuance-temp**

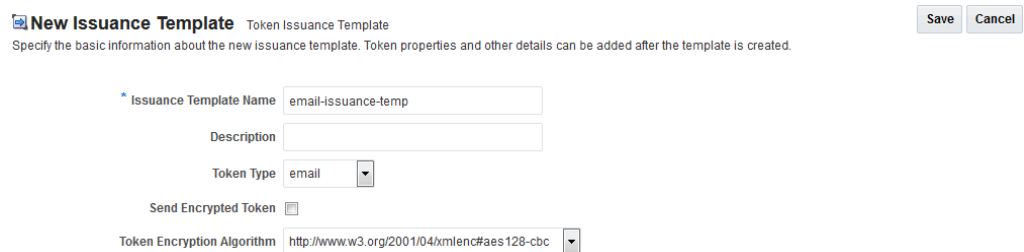

**New Issuance Template** Token Issuance Template

Specify the basic information about the new issuance template. Token properties and other details can be added after the template is created.

Save Cancel

\* Issuance Template Name

Description

Token Type

Send Encrypted Token

Token Encryption Algorithm

When you have a custom token type deployed, the Issuance Properties are tailored to accommodate the custom token. For instance, the custom email token type was chosen for the issuance template.

See [Figure 45-21](#).

**Figure 45-21 Issuance Properties: email-issuance-temp**

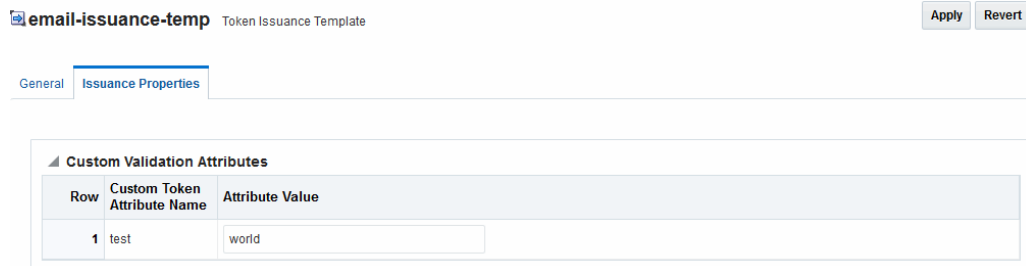

This procedure creates a companion Issuance Template for the custom module classes in this chapter. For the example:

- Ignore the Token Encryption Algorithm, which is not used for the custom token type: email.
- Fill in a value for the Custom Token Attribute, which is populated from the custom token code.

---

**See Also:**

*Oracle Fusion Middleware Administrator's Guide for Oracle Access Management*

---

To create an Issuance Template for custom module classes:

1. In the Oracle Access Management Console, click **Federation** at the top of the window.
2. Select **Token Issuance Templates** from the **View** menu in the **Security Token Service** section.
3. **New Token Issuance Template:**
  - a. Click the **New Issuance Template** button in the upper-right corner (or click the **Add (+)** command button above the Search Results table).
  - b. **General:** Set the following for use with the custom token in this chapter.  
 Issuance Template Name: email-issuance-temp  
 Token Type: email
  - c. Click **Save** and dismiss the confirmation window (or click **Cancel** without saving).
  - d. **Issuance Properties:** Set the following for use with the custom token in this chapter.  
 Custom Token Attribute Value: world
  - e. Click **Apply** and dismiss the confirmation window (or click **Revert** without saving it).

- f. Close the definition (or edit it as described in Step 4).
4. **Edit a Template:** Find the desired template, edit details, and click **Apply**.

### 45.9.3 Adding the Custom Token to a Requester Profile

You can either edit an existing requester profile to add your custom token to the Token Type Configuration table, or create a new requester profile to use with the custom token.

Either way, configure:

- Token Type: email (your custom token)
- Validation Template: email-wstrust-valid-temp

#### 45.9.3.1 Prerequisites for Adding a Custom Token to a Requester Profile

You must define a Custom Token and Validation Template.

#### 45.9.3.2 Adding or Editing a Requester Profile for a Custom Token

You can add or edit a Requester Profile for a custom token from the Security Token Service section.

To add or edit a Requester Profile:

1. In the Oracle Access Management Console Launch Pad, click **Federation** at the top of the window.
2. Select **Partner Profiles** from the **View** menu in the **Security Token Service** section.
3. Select the **Requester Profiles** tab.
4. **Existing Profile:**
  - a. In the Search Results table of the Requester Profiles page, click the name of the desired profiles.
  - b. **Token and Attributes:** Fill in the following details for the custom token in this chapter and then click the Save button at the top of the page.
    - Token type: email
    - Validation Template: email-wstrust-valid-temp
  - c. Click **Save**, dismiss the confirmation window, and close the page (or click **Cancel** to dismiss the page without submitting it).
  - d. Proceed as follows:
    - See "[Adding the Custom Token to a Requester Profile](#)".
5. **New Profile:** Click the **New Requester Profile** button to display the New Partner Profile page where you enter details:
  - a. **General:** Fill in the following details for the custom token in this chapter and then click the Next button at the top of the page.
    - Profile ID: *unique\_requesterprofile\_name*
    - Default Relying Party Profile: *unique\_relyingparty\_name*

- b. **Add Token Type Configuration:** Fill in the following details for the custom token in this chapter and then click the **Save** button at the top of the page.

Token type: email

Validation Template: email-wstrust-valid-temp

- c. Proceed as follows:

See [Adding the Custom Token to a Requester Profile](#).

## 45.9.4 Adding a Custom Token to a Relying Party Profile

You can either edit an existing Relying Party profile, or create a new one to issue the custom token by default, and refer to the Issuance Template and related information.

Either way, configure:

- Default token to issue: email (your custom token)
- Issuance Template: email-issuance-temp

### 45.9.4.1 Prerequisites for Adding a Custom Token to a Relying Party Profile

Your Custom Token and Issuance Template must be defined.

### 45.9.4.2 Editing a Requester Profile for a Custom Module

You can edit a requester profile from a custom module using Security Token Service section.

To edit a requester profile:

1. In the Oracle Access Management Console Launch Pad, click **Federation** at the top of the window.
2. Select **Partner Profiles** from the **View** menu in the **Security Token Service** section.
3. Select the **Relying Party Profiles** tab.
4. **Existing Profile:**
  - a. In the Search Results table of the Relying Party Profiles page, click the name of the desired profile.
  - b. Click the Token and Attributes tab.
  - c. **Token Type Configuration:** Click the **Add (+)** button above the Token Type Configuration table and enter the following details:
    - Token type: email
    - Issuance Template: email-issuance-temp
  - d. **Attributes:** Click the Add (+) button above the Attributes table and define the following:
    - Attribute name: mail
    - Store Type: Userstore
    - Include in Token: (check to enable)
    - Encryption (leave blank)
    - Value (leave blank)

- e. Click **Apply**, dismiss the confirmation window, and close the page (or click Cancel to dismiss the page without submitting it).
5. **New Profile:** Click the New Relying Party Profile button to display the New Partner Profile page where you enter details:
    - a. **General:** Fill in the following details for the custom token in this chapter and then click the Next button at the top of the page.
 

Profile ID: *unique\_relyingparty-name*

Default Token: *email*
    - b. Click the **Token and Attributes** tab and perform Steps 2c and 2d and then click **Apply**.

### 45.9.5 Mapping the Token to a Requestor

If you don't have a Username Validation Template (username-wss-valid-template), use the Oracle Access Management Console to create one to map the token to the requester.

Validation Template Name: username-wss-valid-template

Token Type: Username

Proceed as follows:

See [Creating an /wssuser EndPoint](#).

### 45.9.6 Creating an /wssuser EndPoint

If you want to create an /wssuser EndPoint, you need to follow this procedure:

- [Prerequisites for the Creation of an /wssuser EndPoint](#)
- [Creating an Endpoint](#)

#### 45.9.6.1 Prerequisites for the Creation of an /wssuser EndPoint

See [Mapping the Token to a Requestor](#).

#### 45.9.6.2 Creating an Endpoint

You can create an endpoint using Security Token Service section.

To create an endpoint:

1. In the Oracle Access Management Console Launch Pad, click **Federation** at the top of the window.
2. Select **Endpoints** from the **View** drop-down menu in the **Security Token Service** section.
3. **New Endpoint:**
  - a. Click the **Add (+)** button above the table (or choose New Endpoint from the Actions menu).
  - b. Enter the new Endpoint URI: /wssuser
  - c. Choose the Oracle WSM policy: sts/wss\_username\_service\_policy

- d. Choose the Validation Template: username-wss-validation-template.
- e. Click **Apply** to submit the definition and dismiss the confirmation window (or click **Revert** to dismiss the page without submitting it).
- f. Close the page.



---

## Managing Token Service Partners and Partner Profiles

Administrators manage Token Service Partners and Partner Profiles.

The following topics describe the management of Token Service Partners and Partner Profiles:

- [Prerequisites to Using Token Service Partners and Partner Profiles](#)
- [Introduction to Token Service Partners and Partner Profiles](#)
- [Managing Token Service Partners](#)
- [Managing Token Service Partner Profiles](#)

### 46.1 Prerequisites to Using Token Service Partners and Partner Profiles

See [About the Security Token Service](#).

See [Typical Token Ecosystem](#).

---

**See Also:**

*WLST Command Reference for WebLogic Server*

---

### 46.2 Introduction to Token Service Partners and Partner Profiles

The following topics provide an overview about Token Service partners and partner profiles:

- [About Token Service Partners](#)
- [About Security Token Service Partner Profiles](#)
- [Partner Entries](#)

#### 46.2.1 About Token Service Partners

A Token Service partner represents a partner trusted by the Security Token Service.

[Table 46-1](#) describes the partner types.

**Table 46-1 Security Token Service Partners**

Partner Type	Description
Requester	Represents a Web Service Client interacting directly with Security Token Service in order to issue or validate tokens
Relying Party	References a Web Service Provider that will be the recipient of tokens issued by the Security Token Service server
Issuing Authority	Represents an Assertion issuer. When validating an Assertion, its issuer must be a known Issuing Authority Partner entry in Security Token Service

[Table 46-2](#) describe the Security Token Service that can interact with client types.

**Table 46-2 Security Token Service Clients**

Client Type	Description
Web Service Client	Modules defined as requester partners in Security Token Service (typically SOAP clients).
End users	End users are not defined as requester partners, but possibly present in the User Identity Store.

## 46.2.2 About Security Token Service Partner Profiles

A Partner Profile contains configuration properties that are common to a set of partners, and each partner entry is associated to a Partner Profile.

Similar to the partners, there are three types of partner profiles: Requester, and Issuing Authority Partner Profiles.

- Requester Profile
- Relying Party Profile
- Issuing Authority Partner Profile

### 46.2.2.1 Partner Entries

Security Token Service Partner Entries include Certificates, Reference, and Reference only.

[Table 46-3](#) describes a partner entry:

**Table 46-3 Security Token Service Partner Entry**

Partner Entry	Description
Certificates	Signing and Encryption Certificates
Reference	Reference to a Partner Profile
Requester only	When the partner is a Requester, the partner entry also contains Username Token credentials, and Identification strings used to map incoming data to a requester.

### 46.2.2.2 Partner Profile Data

Security Token Service partner profile data includes requester, Relying Party, and Issuing Authority.

[Table 46-4](#) describes a partner profile entry.

**Table 46-4 Security Token Service Partner Profile Data**

Client Type	Description
Requester	<ul style="list-style-type: none"> <li>Claims Mappings</li> <li>WS-Trust Validation Templates used to validate tokens present in the OnBehalfOf element</li> </ul>
Relying Party	<ul style="list-style-type: none"> <li>Attributes to be sent to RP</li> <li>Issuance Templates to be used</li> </ul>
Issuing Authority	<ul style="list-style-type: none"> <li>Attribute Name/Value Mapping settings</li> <li>Specific Mapping Actions Rules used to map an incoming token to a partner/user</li> </ul>

## 46.3 Managing Token Service Partners

The following topics describe how to manage Token Service partners:

- [New Requester Partner Page](#)
- [Managing a Token Service Partner](#)
- [Refining Partner Searches](#)

### 46.3.1 New Requester Partner Page

When you choose to create a new partner, a fresh page appears for the specific Partner Type you selected.

[Figure 46-1](#) shows the New Requester partner page in the Oracle Access Management Console, which includes all Partner elements.

**Figure 46-1 New Requester Partner Page**

**New Requester** Requester Save Cancel

\* Partner Name

Partner Type Requester

\* Partner Profile

Description

Trusted

**▲ Certificates**

**Encryption Certificate**

No encryption certificate has been added to this partner yet

**Signing Certificate**

No signing certificate has been added to this partner yet

**▲ Username Token Authentication**

Username

Password

Confirm Password

**▲ Identity Attributes**

Attribute	Value
1 sslclientcertdn	<input type="text"/>
2 httpbasicusername	<input type="text"/>

While most elements are common to all partners (name, description, and whether this partner is trusted), certain elements depend upon the specific partner type.

[Table 46-5](#) describe partner elements for partner types.

**Table 46-5 Partner Elements for Partner Types**

Partner Type	Description
Requester partners	Can specify an encryption certificate and a signing certificate, as well as Token Authentication and Identity Attributes.
Relying Party partners	Can specify only an encryption certificate and Resource URLs. See <a href="#">Figure 46-2</a>
Issuing Authority partners	Can specify only a signing certificate.

**Figure 46-2 New Relying Party Partners Page**

Table 46-6 describes elements for Security Token Service partners.

Unless explicitly stated otherwise, all elements apply to every partner type.

**Table 46-6 Elements for Security Token Service Partners**

Element	Description
Partner Name	Enter a name for this partner.
Issuer ID Issuing Authority Only	Unique identifier used in SAML Assertion Issuer field referencing this Issuing Authority.
Partner Type	Uneditable description, depending upon the type of partner you are creating or editing: <ul style="list-style-type: none"> <li>Requester</li> <li>Relying Party</li> <li>Issuing Authority</li> </ul>
Partner Profile	Choose from the profiles listed to define your chosen partner.
Description	Optional.
Trusted	Check this box to indicate whether or not the partner is trusted. If not checked, the Security Token Service server will report an error when a request involves such an entry.
Load Certificate	Browse for and upload the requested certificates, which depend on partner type: <ul style="list-style-type: none"> <li>Encryption and signing certificates</li> <li>Encryption certificate</li> <li>Signing certificate</li> </ul>

**Table 46-6 (Cont.) Elements for Security Token Service Partners**

Element	Description
Username Token Authentication <i>Requester only</i>	<p>Values can be entered for the following for Username Token Authentication:</p> <ul style="list-style-type: none"> <li>• Username</li> <li>• Password</li> <li>• Confirm Password</li> </ul> <p>New Requester Partner Identification Attributes can be defined in the STS Settings section and will appear in the requester partner Identity Attributes table.</p> <p>Note: the username and password data will be used to validate the credentials of a username token. It is also possible to only enter a username and no password, when the data will be used only to map an incoming token to this requester partner using the username.</p>
Identity Attributes <i>Requester only</i>	<p>At runtime, Security Token Service will use the data defined in the section to map an incoming request to a requester partner entry, using:</p> <ul style="list-style-type: none"> <li>• The token data or binding data such as the SSL Client Certificate's Subject DN if present, or HTTP Basic Authentication username.</li> <li>• The identity attributes present in each requester partner entry.</li> </ul> <p>New mappings can be added in the Relying Party Partner section as follows: <code>http://relying.party.test.com/testing.service</code>. At runtime, the Security Token Service server will use those URLs to map the AppliesTo service location contained in a WS-Trust request to a Relying Party Partner.</p>
Resource URL <i>Relying Party only</i>	<p>Enter the resource URL in the resource pattern column of the table, and enter a description beside it. For instance:</p> <p>Pattern: <code>http://relying.party.test.com/testing/service</code></p> <p>The resource URL listed in the table will be used when mapping the AppliesTo location element from the WS-Trust request to this Relying Party Partner.</p> <p>The AppliesTo location value will be mapped to this Relying Party Partner:</p> <ul style="list-style-type: none"> <li>• A Resource URL matches exactly the AppliesTo location value. For example, the AppliesTo location is <code>http://relying.party.test.com/testing/service</code> and the Resource URL is also <code>http://relying.party.test.com/testing/service</code>.</li> <li>• Or, a Resource URL is the parent of the AppliesTo location value. For example, the AppliesTo location is <code>http://relying.party.test.com/testing/service</code> and the Resource URL is <code>http://relying.party.test.com/testing</code>, or Resource URL is <code>http://relying.party.test.com/</code></li> </ul>

### 46.3.2 Managing a Token Service Partner

Users with valid Administrator credentials can create, find, edit, or delete a token service partner using Oracle Access Management Console.

#### Prerequisites

A partner profile must be defined for the type of partner you will create.

### To manage a token service partner

1. In the Oracle Access Management Console, click **Federation** at the top of the window.
2. In the Federation console, select **Partners** from the **View** menu in the **Security Token Service** section.
3. Select the desired partner type tab and proceed with following steps as needed.
  - **Requesters**
  - **Relying Parties**
  - **Issuing Authorities**
4. **New Partner:**
  - a. Click the **New [Partner Type]** button to display a fresh page for your definition.
  - b. Enter general information for the chosen partner type ([Table 46-6](#)).
  - c. **Trusted:** Click to select (or leave blank if this is not a trusted partner).
  - d. **Certificates:** Load any necessary certificates.
  - e. **Relying Party:** Enter Resource URLs, if needed.
  - f. **Issuing Authority:** Enter the Issuer ID of this Authority.
  - g. **Requester:** Enter Username Token credentials, if needed.
  - h. Click **Save** to submit (or click **Cancel** to dismiss the page) and then dismiss the confirmation window.
5. **Refine a Partner Search:** "[Refining Partner Searches](#) "
  - a. Perform Steps 1 and 2.
  - b. Define your query and click the **Search** button.
  - c. In the Search Results table, click the name of partner to view, edit, or remove.
6. **Edit a Partner:**
  - a. In the Search Results table, click the name of partner to edit and click the **Edit** button (or choose **Edit** from the **Actions** menu).
  - b. Make desired changes to partner information ([Table 46-6](#)).
  - c. Click **Apply** to submit the changes (or **Revert** to cancel changes) and then dismiss the confirmation window.
7. **Remove a Partner:** Use the Search controls to refine and submit your query, as needed.
  - a. In the Search Results table, highlight the row containing the partner to remove.

- b. Click the Delete (X) button (or choose Delete Selected from the Actions menu), then dismiss the confirmation window.

### 46.3.3 Refining Partner Searches

From the console Launch Pad, when you click Partners, all Partner types can be viewed from tabs. When you choose a specific Partner, relevant Search controls, and the Search Results table, become available.

Figure 46-3 illustrates a Requester Partner, where only the results differ from that of other Partner Types.

**Figure 46-3 Partner Search Controls**

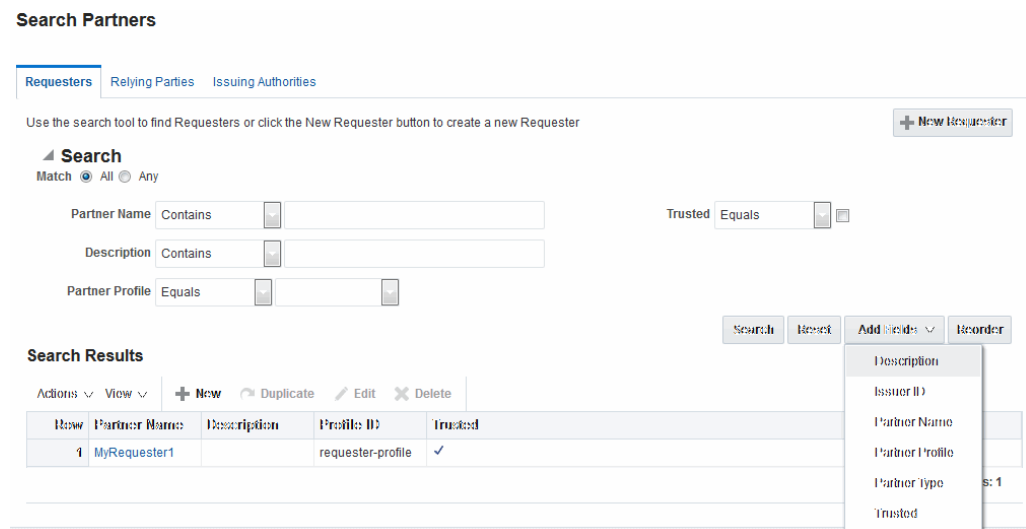

From the Search page you can simply select a name in the Search Results table, or use the controls to refine your search to locate a specific Partner or Partners with specific characteristics.

## 46.4 Managing Token Service Partner Profiles

The following topics describe Token Service Partner Profiles.

- [About Managing Partner Profiles](#)
- [Managing a Token Service Partner Profile](#)
- [Refining a Profile Search](#)

### 46.4.1 About Managing Partner Profiles

The following topics describe elements in the following pages:

- [Requester Profile: General](#)
- [Requester Profile: Token and Attributes](#)
- [Relying Party Profile: Token and Attributes](#)
- [Relying Party Profile Attributes](#)
- [Issuing Authority Profile: Token and Attributes](#)



- [Issuing Authority Profile: Token Mapping](#)

#### 46.4.1.1 Requester Profile: General

The Requester Profile page has the **General** tab that contains General elements for all profile types.

Figure 46-4 shows a completed Requester Profile page, with both a General tab and Token and Attributes tab.

**Figure 46-4 Requester Profile: General**

Table 46-7 describes the General elements for all profile types.

**Table 46-7 Profile: General**

Element	Description
Profile ID	A unique identifier for this profile
Description	Optional.
Profile Type	Type of profile, which cannot be edited: Requester, Relying Party or Issuing Authority.
Default Relying Party Profile <i>Requester Partner Profile Only</i>	<p>References the Relying Partner Profile to use, if the WS-Trust request does not reference the Relying Party (for example, the AppliesTo element is missing), or if the AppliesTo element could not be mapped to a known Relying Party Partner Profile.</p> <p>Choose a Relying Party profile to use as the default and enable or disable the following characteristics as needed:</p> <ul style="list-style-type: none"> <li>• Return error for missing claims. Indicates whether or not Security Token Service will return an error if the issued token does not contain claims that were requested by the client. Since the Relying Party Partner Profile defines the list of attributes/claims that can be included in the issued token, it is possible that some claims requested by the client cannot be returned.</li> <li>• Allow unmapped claims. Claims listed in a WS-Trust request are specified in a dialect that will be translated to map to local attributes using the Token and Attributes section. This flag indicates whether or not claims that cannot be translated should be referenced as is. This allows to control which claims can be requested by the client.</li> </ul>

**Table 46-7 (Cont.) Profile: General**

Element	Description
Default Token to Issue <i>Relying Party Only</i>	<p>This table indicates which Issuance Template to use to issue a token for Relying Parties linked to this profile.</p> <p>Choose a token type as the default for this profile:</p> <ul style="list-style-type: none"> <li>• SAML 1.1</li> <li>• SAML 2.0</li> <li>• Username</li> <li>• Custom</li> </ul> <p>Check the box beside Download Policy to associate a policy with the token. When checked, Security Token Service will download at runtime the WS-Security policy of the Relying Party referenced by the AppliesTo element in the RST. If present, Security Token Service will use that URL to download the policy, and then determine the type of token to return based on the information located in the policy.</p>

#### 46.4.1.2 Requester Profile: Token and Attributes

The Token Type Configuration section indicates which WS-Trust Validation Template to use to validate tokens contained in the OnBehalfOf element of the WS-Trust request, based on the token type.

This section defines mappings between WS-Trust claims requested by the client and local attribute names.

Figure 46-5 illustrates the Token and Attributes tab and accompanying tables for the Requester profile.

**Figure 46-5 Requester Profile: Token and Attributes**

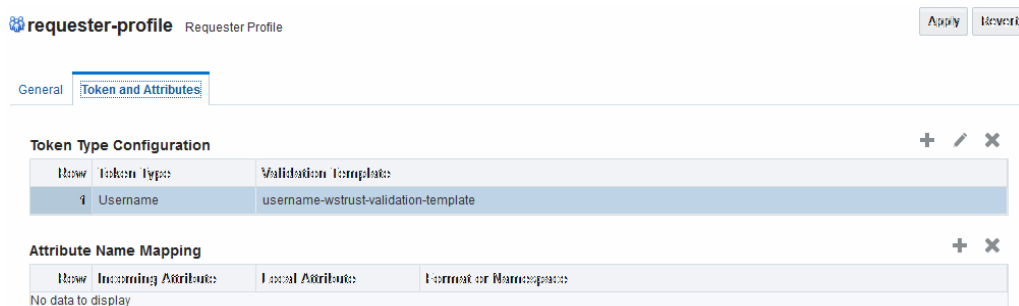

Table 46-8 describes Requester Profile Token and Attributes elements and controls.

Figure 46-6 illustrates the Token and Attributes defined for a Relying Party Profile.

**Table 46-8 Requester Profile: Token and Attributes**

Element	Description
Token Type Configuration	<p>Click the + above the table to display a dialog box and then make one selection from each of the following drop down lists:</p> <ul style="list-style-type: none"> <li>Token Type list provides all supported (and custom) token types deployed.</li> <li>Validation Template list contains all currently defined WS-Trust validation templates.</li> </ul>
Attribute Name Mapping	<p>This table defines how Security Token Service maps a claim, represented by its name and optional Format/Namespace, to a local attribute.</p> <p>Security Token Service supports the Infocard Claims dialect. To translate Infocard claims to local attributes, a mapping will need to be defined where the Incoming Attribute will contain the claim name and the Local Attribute will contain the local name (The Format/Namespace column will be empty).</p> <p>For example, one mapping could be:</p> <ul style="list-style-type: none"> <li>Incoming Attribute: surname</li> <li>Local Attribute: sn</li> </ul> <p>Another mapping could be:</p> <ul style="list-style-type: none"> <li>Incoming Attribute: givenname</li> <li>Local Attribute: givenname</li> </ul> <p>Another mapping could be:</p> <ul style="list-style-type: none"> <li>Incoming Attribute: emailaddress</li> <li>Local Attribute: mail</li> </ul>

#### 46.4.1.3 Relying Party Profile: Token and Attributes

An Administrator can define which Issuance Template should be used to issue a token for a Relying Party associated with this profile.

Also, it lists the attributes that might be included in an issued token, by their names, the source of those attributes, and whether or not the attributes should be included in the issued token only if requested by the client or always.

On this page, Relying Party Profiles require an Issuance Template in addition to the token type. Also, the attribute types differ from other profiles.

[Figure 46-6](#) illustrates the Token and Attributes defined for a Relying Party Profile.

**Figure 46-6 Relying Party Profile Token and Attributes**

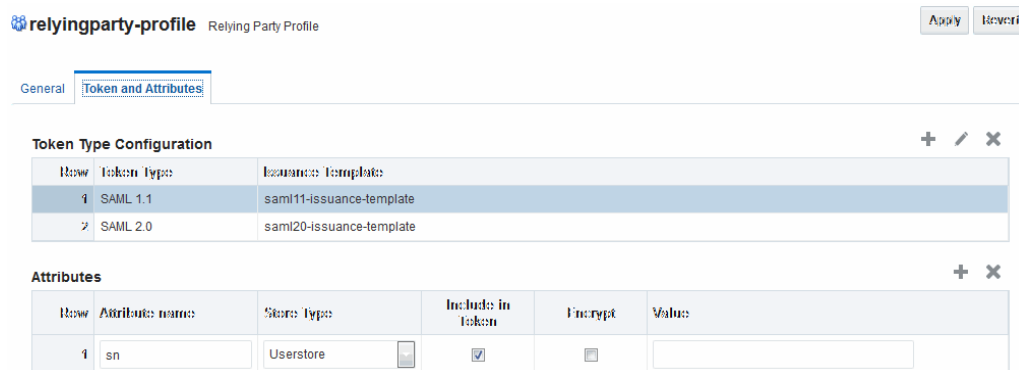

Table 46-9 describes the elements needed for the Relying Party Profile.

**Table 46-9 Relying Party Profile Requirements**

Element	Description
Token Type Configuration	<p>Click the + above the table to display a dialog box and then make one selection from each drop down list:</p> <ul style="list-style-type: none"> <li>Token Type list provides all supported (and custom) token types deployed.</li> <li>Issuance Template list contains all currently defined Issuance Templates.</li> </ul>
Attributes	<p>The attributes that might be included in an issued token:</p> <ul style="list-style-type: none"> <li>Attribute Name: Indicates the name of the attribute.</li> <li>Store Type: Indicates the source of the attribute:                             <ul style="list-style-type: none"> <li>Userstore: the default User Identity Store where the LDAP user record will be used to retrieve the attribute value.</li> <li>Incoming Token: the attribute will reference an element of the incoming token.</li> <li>Static: the value will be specified in the Value field.</li> </ul> </li> <li>Include in Token: Indicates whether or not the attribute should always be included in the issued token. If unchecked, the attribute will only be included if the client requested this attribute.</li> <li>Encrypt: Indicates whether or not the attribute should be encrypted.                             <p>Note: only supported for SAML 2.0. Also, the Encryption Certificate must be set in the Relying Party Partner entry, or it must be present in the WS-Trust request.</p> </li> <li>Value: Contains the value to be used if the Store Type is static value.</li> </ul> <p>See Also: "<a href="#">Relying Party Profile Attributes</a>".</p>

#### 46.4.1.4 Relying Party Profile Attributes

You can define attributes of a Relying Party profile and indicate the source and value of the attribute.

When defining an attribute, you can indicate:

- The attribute source: User Store (LDAP), Incoming Token Data or static value.

- Whether or not to include the attribute in the token only if requested by the client or in all tokens.
- Whether or not to encrypt the attribute (only SAML 2.0; requires the Relying Party Encryption Certificate).
- The value of the attribute if this is a static attribute.

Example: To include the mail attribute retrieved from LDAP in all outgoing tokens:

- Attribute Name: mail
- Store Type: User Store
- Include in Token: checked
- Encrypt: unchecked
- Value: empty

Example: To include the username element of an incoming Username Token in all outgoing tokens

- Attribute Name: STS\_SUBJECT\_ID
- Store Type: Incoming Token
- Include in Token: checked
- Encrypt: unchecked
- Value: empty

Example: To include a static attribute in all outgoing tokens:

- Attribute Name: rp-version
- Store Type: Static
- Include in Token: checked
- Encrypt: unchecked
- Value: 2.0

The following attributes are available from the incoming token data. The SAML attributes referenced by their names are also available as incoming token data:

#### **STS\_SUBJECT\_ID**

Contains the subject identifier (username for Username token, NameID Value for SAML assertions, Subject DN for X.509 certificates)

#### **STS\_NAMEID\_FORMAT**

Contains the SAML NameID Format.

#### **STS\_NAMEID\_QUALIFIER**

Contains the SAML NameID Format.

#### **STS\_SPNAME\_QUALIFIER**

Contains the SAML NameID Qualifier.

**STS\_SP\_PROVIDED\_ID**

Contains the SAML NameID SP Qualifier

**STS\_SESSION\_INDEX**

Contains the session index.

**STS\_AUTHENTICATION\_INSTANT**

Contains the authentication instant (current after Username token credentials validation, from the authentication statement for SAML Assertions, current for X.509 validation, current for Kerberos Validation, authentication instant for OAM Session Propagation tokens).

**STS\_AUTHENTICATION\_TIMEOUT**

Contains the session expiration time if set (applies to SAML assertions and OAM Session Propagation tokens if present).

**STS\_X509\_CN**

Contains the CN component of the X.509 Certificate's Subject DN

**STS\_X509\_OU**

Contains the OU component of the X.509 Certificate's Subject DN.

**STS\_X509\_O**

Contains the O component of the X.509 Certificate's Subject DN.

**STS\_X509\_L**

Contains the L component of the X.509 Certificate's Subject DN.

**STS\_X509\_ST**

Contains the ST component of the X.509 Certificate's Subject DN.

**STS\_X509\_C**

Contains the C component of the X.509 Certificate's Subject DN.

**STS\_X509\_DC**

Contains the DC component of the X.509 Certificate's Subject DN.

**STS\_X509\_\***

Contains the component identified by \* of the X.509 Certificate's Subject DN.

**STS\_X509\_VERSION**

Contains the version attribute of the X.509 Certificate.

**STS\_X509\_ISSUER\_X500\_PRINCIPAL\_NAME**

Contains the issuer DN of the X.509 Certificate.

**STS\_X509\_NOT\_AFTER**

Contains the not after attribute of the X.509 Certificate.

**STS\_X509\_NOT\_BEFORE**

Contains the not before attribute of the X.509 Certificate.

**STS\_X509\_SUBJECT\_X500\_PRINCIPAL\_NAME**

Contains the subject DN of the X.509 Certificate.

**STS\_X509\_SUBJECT\_ALTERNATIVE\_NAMES**

Contains the subject alternative name extension value of the X.509 Certificate.

**STS\_X509\_SERIAL\_NUMBER**

Contains the serial number of the X.509 Certificate.

**STS\_OAM\_LAST\_ACCESS\_TIME**

Contains the last access time of the OAM Session Propagation Token.

**STS\_OAM\_LAST\_UPDATE\_TIME**

Contains the last update time of the OAM Session Propagation Token.

**STS\_OAM\_CREATION\_TIME**

Contains the creation time of the OAM Session Propagation Token.

**STS\_KERBEROS\_PRINCIPAL\_SHORT**

Contains the Principal Short value of the Kerberos Token.

**STS\_KERBEROS\_PRINCIPAL\_FULL**

Contains the Principal Full value of the Kerberos Token.

**STS\_KERBEROS\_PRINCIPAL\_NODOMAIN**

Contains the Principal No Domain value of the Kerberos Token.

**STS\_SAML\_ASSERTION\_ID**

Contains the AssertionID of the SAML Assertion.

**STS\_SAML\_SUBJECT\_DNS**

Contains the Subject DNS attribute of the SAML Assertion.

**STS\_SAML\_SUBJECT\_IP\_ADDRESS**

Contains the Subject IP Address attribute of the SAML Assertion.

**STS\_SAML\_ASSERTION\_ISSUER**

Contains the Issuer of the SAML Assertion.

**STS\_SAML\_AUTHN\_INSTANT**

Contains the authentication instance of the SAML Assertion.

**STS\_SAML\_AUTHN\_METHOD**

Contains the authentication method of the SAML Assertion.

**46.4.1.5 Issuing Authority Profile: Token and Attributes**

The Issuing Authority Partner Profile defines settings that can be common to different Issuing Authority Partners.

The Token and Attributes section allows the Administrator to define mapping rules that is used to translate the name and value of attributes to local names and values.

[Figure 46-7](#) show the Token and Attributes: Issuing Authority section.

**Figure 46-7 Token and Attributes: Issuing Authority**

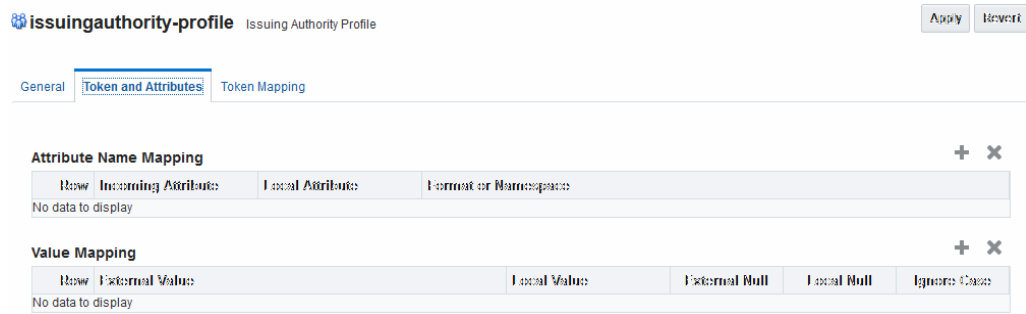

It is possible to define attribute mapping rules that will be applied to the attributes included in the Assertion, when extracting them from the token. There are two different sets of rules:

- Attribute name mapping where the name of a SAML Attribute can be translated to a local name (for example, firstname could be translated to givenname).
- Attribute value mapping where the value of a SAML Attribute can be translated to a local value (for example, President to CEO).
- [Table 46-10](#) describes the Token and Attributes elements for Issuing Authority.

**Table 46-10 Token and Attributes Elements: Issuing Authority**

Element	Description
Attribute Name Mapping	<p>Define an optional mapping between the name of a SAML Attribute and the local name of an attribute.</p> <p>The mapping is optional. If an attribute does not have a mapping defined, then its SAML attribute name will be used.</p> <ul style="list-style-type: none"> <li>• Incoming Attribute: Contains the external name of the attribute as it will appear in the Assertion.</li> <li>• Local Attribute: Contains the local name of the attribute.</li> <li>• Format or Namespace: Contains an optional Format or Namespace. If missing, the namespace value for mapping purposes will be assumed to be <code>urn:oracle:security:fed:attrnamespace</code> for SAML 1.1 Assertions or the format value for mapping purposes will be assumed to be <code>urn:oasis:names:tc:SAML:2.0:attrname-format:basic</code> for SAML 2.0 Assertions</li> </ul>



**Table 46-10 (Cont.) Token and Attributes Elements: Issuing Authority**

Element	Description
Value Mapping	<p>Define an optional value mapping for a SAML attribute. This will indicate how to translate an attribute value to a local value, if needed.</p> <p>Note: This attribute value mapping applies to an Attribute Name mapping. In order to define an attribute mapping for an attribute, it is required to first define an attribute name mapping for that attribute.</p> <ul style="list-style-type: none"> <li>• External Value: Contains the value of the SAML Attribute.</li> <li>• Local Value: Contains the local value that will be set, if the SAML attribute value matches the External Attribute/Local Null fields.</li> <li>• External Null: Represents a null SAML attribute value.</li> <li>• Local Null: Indicates if the local value should be null, if the SAML attribute value matches the External Attribute/Local Null fields.</li> <li>• Ignore Case: Indicates whether or not Security Token Service should ignore case when comparing the attribute value to the Local Attribute field.</li> </ul>

#### 46.4.1.6 Issuing Authority Profile: Token Mapping

Administrators can override the Mapping Rules defined in a SAML Validation Template with the ones defined in an Issuing Authority Partner Profile. Then the Security Token Service can map SAML Assertions based on rules specific to a set of Assertion Issuers.

Using the Token Mapping tab, Administrator can override the mapping rules. See [Figure 46-8](#) for more details.

[Table 46-10](#) describes the Token Mapping elements for the Issuing Authority.

**Figure 46-8 Issuing Authority Profile: Token Mapping Tab**

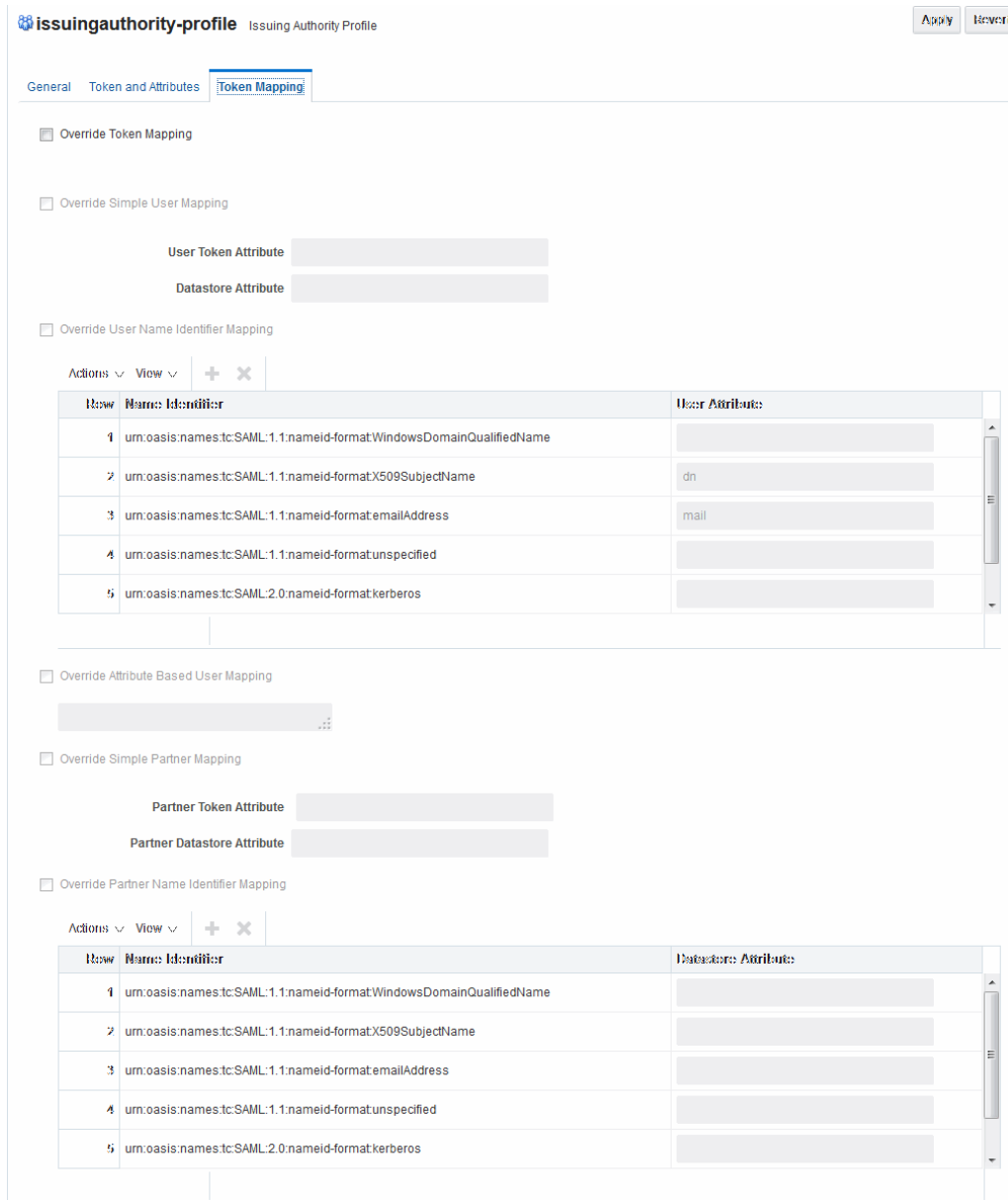

**Table 46-11 Issuing Authority Token Mapping Elements**

Element	Description
Override Token Mapping	Indicates whether or not the Mapping Rules defined in this section should override the ones listed in the SAML Validation Template used to process the assertion. This allows Security Token Service to use Mapping Rules that are specific to the Assertion Issuer. If true, all the Mapping Rules will be overridden by the settings listed in this section.

**Table 46-11 (Cont.) Issuing Authority Token Mapping Elements**

Element	Description
Override Simple User Mapping	<p>Simple user mapping consists of mapping the incoming token to a user record by using a single token attribute and matching it against a single user record attribute.</p> <ul style="list-style-type: none"> <li>• User Token attribute references an attribute from the incoming token that will be matched against the Datastore attribute (defined below) of a user record. The values can be STS_SUBJECT_ID for the NameID Value, or the name of an Attribute contained in the Assertion's AttributeStatement</li> <li>• Datastore attribute references the user record attribute that will be matched against the User token attribute referenced above</li> </ul>
Override User Name Identifier Mapping	<p>When enabled, define a NameID user mapping operation, which consists of mapping the incoming SAML Assertion to a user record by mapping the NameID Value to a single user record attribute, based on the NameID format.</p> <p>When enabled, Security Token Service will evaluate the NameID format, and based on the Name Identifier mapping table which user record attribute should be matched against the Name ID value contained in the Assertion. The Name Identifier mapping table holds the user record attributes to be used for the mapping operation. It contains standard NameID formats, but it can be customized to define custom Name ID formats.</p> <ul style="list-style-type: none"> <li>• To add custom NameID format, click the add button on the Name Identifier mapping table, and enter the custom URI.</li> <li>• To set an attribute for a specific NameID format to be used for mapping operation, set the user record attribute on the line for that format.</li> </ul>
Override Attribute Based User Mapping	<p>An Attribute Based User Mapping operation consists of mapping the incoming token to a user record by using an LDAP query and token attributes.</p> <p>The format of the LDAP query defines the mapping rule and specifies the token attributes to be used by their names, surrounded by % character. For example, an LDAP query that will map a token based on two token attributes (firstname and lastname) would be:</p> <pre data-bbox="800 1518 1271 1543">(&amp;(sn=%lastname)(givenname=%firstname%))</pre> <p>STS_SUBJECT_ID contains the NameID Value.  STS_NAMEID_FORMAT contains the NameID Format  STS_NAMEID_QUALIFIER contains the NameID Qualifier  STS_SAML_ASSERTION_ISSUER contains the Issuer of the Assertion  Attributes present in the Assertion's AttributeStatement</p>

**Table 46-11 (Cont.) Issuing Authority Token Mapping Elements**

Element	Description
Override Simple Partner Mapping	<p>A simple partner mapping operation consists of mapping the incoming token to a partner requester by using a single token attribute and matching it against a partner identification attributes.</p> <ul style="list-style-type: none"> <li>Partner Token attribute references an attribute from the incoming token that will be matched against the Partner Datastore attribute (defined below) of a Requester Partner. The values can be STS_SUBJECT_ID for the NameID Value, or the name of an Attribute contained in the Assertion's AttributeStatement.</li> <li>Partner Datastore attribute references the partner identification attribute that will be matched against the Partner token attribute referenced above.</li> </ul>
Override Partner Name Identifier Mapping	<p>When enabled, define the following: A NameID user mapping operation consists of mapping the incoming SAML Assertion to a user record by mapping the NameID Value to a single requester partner identification attribute, based on the NameID format.</p> <p>When enabled, Security Token Service will evaluate the NameID format, and based on the Name Identifier mapping table which partner identification attribute should be matched against the Name ID value contained in the Assertion. The Name Identifier mapping table holds the requester partner identification attributes to be used for the mapping operation. It contains standard NameID formats, but it can be customized to define custom Name ID formats.</p> <ul style="list-style-type: none"> <li>To add custom NameID format, click the add button on the Name Identifier mapping table, and enter the custom URI.</li> <li>To set an attribute for a specific NameID format to be used for mapping operation, set the requester partner identification attribute on the line for that format.</li> </ul>

## 46.4.2 Managing a Token Service Partner Profile

Users with valid Administrator credentials can use create, locate, view, edit, or remove a token service partner profile.

### Prerequisites

The prerequisites for Requester Partner Profiles are:

- A Relying Party Partner Profile must exist, in order to be able to set the default Relying Partner Profile.
- WS-Trust Validation Templates must exist in order to set the templates that will be used to validate tokens located in the OnBehalfOf element.

The prerequisites for Relying Partner Profiles are:

- Issuance Template must exist in order to configure which templates to use for token issuance operations.

There are no prerequisites for Issuing Authority Partner Profiles.

**To create, find, edit, or remove a partner profile**

1. In the Oracle Access Management Console, click **Federation** at the top of the window.
2. In the Federation console, select **Partner Profiles** from the **View** drop-down menu in the **Security Token Service** section.
3. Select the desired profile type tab and proceed with following steps as needed.
  - Requester Profiles
  - Relying Party Profiles
  - Issuing Authority Profiles
4. **New Profile:**
  - a. Click the **New [Profile Type]** button to display a fresh page for your definition.
  - b. Enter general information for the chosen profile type ([Table 46-7](#)) and click the **Next** button.
  - c. **Token and Attributes:** Use the appropriate table to provide details for the chosen profile type:
    - Requester Profile [Table 46-8](#)
    - Relying Party Profile [Table 46-9](#)
    - Issuing Authority Profile [Table 46-10](#)
  - d. Click **Save** to submit (or click **Cancel** to dismiss the page) and then dismiss the confirmation window.
5. **Refine a Profile Search:**

See [Refining a Profile Search](#).

  - a. Perform Steps 1 and 2.
  - b. Define your query and click the **Search** button.
  - c. In the Search Results table, click the name of partner to view, edit, or remove.
6. **Edit a Profile:**
  - a. In the Search Results table, click the name of profile to edit and click the **Edit** button (or choose **Edit** from the **Actions** menu).
  - b. Make desired changes to partner information.
    - Requester Profile [Table 46-8](#)
    - Relying Party Profile [Table 46-9](#)
    - Issuing Authority Profile [Table 46-10](#)
  - c. Click **Apply** to submit the changes (or **Revert** to cancel changes) and then dismiss the confirmation window.

7. **Remove a Profile:** To remove a profile, it is required not to be referenced anywhere else.

To remove a Requester Partner Profile, it is required that:

- No Requester Partner references the profile.
- No WS-Security Validation Template references the profile

To remove a Relying Party Partner Profile, it is required that:

- No Relying Party Partner references the profile.
- No Requester Partner Profile references the profile.

To remove an Issuing Authority Partner Profile, it is required that:

- No Issuing Authority Partner references the profile

If these prerequisites are met, proceed as follows:

- a. In the Search Results table, highlight the row containing the profile to remove.
- b. Click the Delete (X) button (or choose Delete Selected from the Actions menu), then dismiss the confirmation window.

### 46.4.3 Refining a Profile Search

As with Partner definitions, when you open the Partner Profiles node, all Partner Profiles nodes become available. When you choose a specific type of Partner Profile node, relevant Search controls, and the Search Results table, become available.

This one is for a Requester Profile. However, all controls are the same; only the results differ for different profile types.

Figure 46-3 illustrates a typical Search Profiles page.

**Figure 46-9 Search Partner Profiles Page: Requester Profiles**

**Search Partner Profiles**

Requester Profiles | Relying Party Profiles | Issuing Authority Profiles

Use the search tool to find Issuing Authority Profiles or click the New Issuing Authority Profile button to create a new Issuing Authority Profile + New Requester Profile

**Search**  
Match  All  Any

Profile ID Contains

Description Contains

Search Reset Add Fields Reorder

**Search Results**

Actions View + New Duplicate Edit Delete

Row	Profile ID	Description
1	requester-profile	

Number of Rows: 1

From the Search page you can simply select a name in the Search Results table to view or edit the Profile, or use the controls to refine your search to locate a specific Profile or a Profile with specific characteristics.

---

## Troubleshooting Security Token Service

Diagnose and fix some common problems encountered during Security Token Service configuration.

This chapter provides troubleshooting tips for Security Token Service:

- [Authorization Issues](#)
- [Endpoint Issues](#)
- [Mapping Operation Issues](#)

### 47.1 Authorization Issues

#### **Problem: Authorization Failure during Token Issuance operation**

During a WS-Trust request issuance operation, the Security Token Service returns an error.

#### **Error Message**

The following are sample error messages that can be seen in the logs:

```
<Error> <oracle.security.fed.controller.ApplicationController> <STS-12064>
<Exception: {0}
oracle.security.fed.event.EventException: oracle.security.fed.event.EventException:
Authorization Failure for Relying Party=%RELYING_PARTY_ID%, Requester=%REQUESTER_ID%
and User=%USER_ID%
```

When:

- %RELYING\_PARTY\_ID% indicates the Relying Party Partner ID.
  - If the WS-Trust request did not contain an AppliesTo element, then the %RELYING\_PARTY\_ID% is set to MissingRP
  - if the WS-Trust request contained an AppliesTo element but it could not be mapped to a Relying Party Partner, then the %RELYING\_PARTY\_ID% is set to UnknownRP
  - if the WS-Trust request contained an AppliesTo element and it was mapped to a Relying Party Partner, then the %RELYING\_PARTY\_ID% is set to Relying Party Partner ID.
- %REQUESTER\_ID% is set to the Requester Partner ID, if the incoming request was mapped to a Requester Partner. If %REQUESTER\_ID% is not null, it will be used when evaluating the Token Issuance Policy, against any present Identity Condition.

- %USER\_ID% is set to the User ID, if the incoming request was mapped to a user record. If %USER\_ID% is not null and if %REQUESTER\_ID% is null, it will be used when evaluating the Token Issuance Policy, against any present Identity Condition.

### Issue

The Token Issuance Policy evaluation failed due to one of the following reasons:

- No TokenServiceRP resource referencing the %RELYING\_PARTY\_ID% is defined and assigned to a Token Issuance Policy. In this case, create TokenServiceRP resource referencing the %RELYING\_PARTY\_ID% and assign it to a Token Issuance Policy.
- A TokenServiceRP resource referencing the %RELYING\_PARTY\_ID% exists and is assigned to a Token Issuance Policy, but the policy contains conditions that are not met. In this case, review the policy rules: if the policies are correct, then the client is not allowed to request a token; otherwise, update the policies/conditions to include the client's identity.

## 47.2 Endpoint Issues

### Problem: Endpoint not found

When accessing an Security Token Service endpoint that has been added via the Oracle Access Management Console, the server returns an error indicating that the page does not exist when retrieving the WSDL policy or that the endpoint does not exist.

### Error Message

The following are possible error messages:

- When retrieving the WSDL policy, a 404 HTTP error code is returned.
- When sending a WS-Trust request, an error is reported:

```
<Error> <oracle.webservices.service> <OWS-04115> <An error occurred for port:
PortableProvider: oracle.j2ee.ws.server.EndpointNotFoundException: /PATH.>
```

### Solution

Security Token Service is deployed but not enabled. To enable Security Token Service, perform the following operations:

1. In the Oracle Access Management Console, click **Configuration** at the top of the window.
2. In the Configuration console, click **Available Services**.
3. **Enable** the Security Token Service.

Security Token Service detects the change and publishes the endpoints. No restart is required.



## 47.3 Mapping Operation Issues

### Problem: Failure to map the AppliesTo element to a Relying Party Partner

When Security Token Service processes a WS-Trust request with an AppliesTo element referencing the Web Service Provider, the server will attempt to map the location contained in the AppliesTo element to an Security Token Service Relying Party Partner using the Resource URL defined in the Partner entry. If such a mapping fails, the server will log an Info message in the logs indicating that the operation failed and indicating what was the AppliesTo address used.

### Error Message

The following is a sample of an error message:

```
[2011-04-22T15:08:12.632-07:00] [oam_server1] [NOTIFICATION] [STS-15542]
[oracle.security.fed.eventhandler.sts.creation.v13.CreateV13TokenEventHandler] [tid:
[ACTIVE].ExecuteThread: '0' for
queue: 'weblogic.kernel.Default (self-tuning)'] [userId: <anonymous>] [ecid:
f00aaca2d3f3ded:125005ed:12f7f412274:-8000-0000000000000016,0]
[WEBSERVICE_PORT.name: wssuser-port] [APP:
oam_server] [J2EE_MODULE.name: sts] [WEBSERVICE.name: wssuser-serviceSoap12]
[J2EE_APP.name: oam_server] The mapping
of the AppliesTo element from the WS-Trust Request to a Relying Party Partner
failed: could not map
http://relying.party.test.com/testing/service
```

### Solution

If the AppliesTo location should have been mapped to a Relying Party Partner, then the Partner settings should be verified to ensure that the Resource URLs are correctly defined to:

- be the exact match of the AppliesTo address
- be a parent of the AppliesTo address.

For example, if the AppliesTo address is `http://relying.party.test.com/testing/service`, a parent could be `http://relying.party.test.com/testing/` or `http://relying.party.test.com/`. In both cases, the AppliesTo location would be mapped to a Relying Party Partner with any of those Resource URLs defined.

---



---

#### Note:

this message is recorded at Notification level, thus in order for Security Token Service to record it, the appropriate logging level must be set to include the Notification:1 level.

---



---

In certain cases, failure to correctly map the AppliesTo address to a Relying Party Partner will result in errors due to:

- Authorization evaluation failures
- Security Token Service not being able to retrieve certificate belonging to the Relying Party Partner.



# Part XI

---

## Managing Oracle Access Management Mobile and Social

This part documents Oracle Access Management Mobile and Social.

Mobile and Social serves as an intermediary between a user or client seeking to access protected resources, and the back-end Oracle Access Management and Oracle Identity Management services that protect the resources. Mobile and Social provides simplified client libraries that allow developers to quickly add feature-rich authentication, authorization, and Identity capabilities to registered applications. On the back-end, the Mobile and Social service's pluggable architecture lets system Administrators customize the access management services without having to update the installed software.

Part IX contains the following chapters:

- [Understanding Mobile and Social](#)
- [Configuring Mobile and Social Services](#)
- [Configuring Social Identity](#)
- [Configuring OAuth Services](#)
- [Configuring Social Identity System Settings](#)



---

## Understanding Mobile and Social

This chapter describes the purpose and capabilities of Oracle Access Management Mobile and Social. It includes the following topics.

- [Introducing Mobile and Social](#)
- [Understanding Mobile and Social Services](#)
- [Understanding the Mobile and Social Services Processes](#)
- [Using Mobile and Social Services](#)
- [Understanding Social Identity](#)
- [Understanding Social Identity Processes](#)
- [Using Social Identity](#)

### 48.1 Introducing Mobile and Social

The Oracle Access Management Mobile and Social service acts as an intermediary between a user or client seeking to access protected resources, and the back-end Access Management and Identity Management services that protect the resources.

Mobile and Social provides simplified client libraries that allow developers to quickly add feature-rich authentication, authorization, and identity capabilities to registered applications. On the back-end, the Mobile and Social server's pluggable architecture lets system administrators customize identity and access management services without updating the user's client software or mobile applications. Mobile and Social provides two complimentary feature sets:

- *Mobile and Social Services* (formerly *Mobile Services*) connects applications and devices to the enterprise Access Management and Identity Management services available in the Oracle Identity Access Management product suite. This makes it easy to utilize sophisticated authentication and authorization services functionality (such as mobile device and application registration, and device fingerprinting) to restrict access to authorized devices only. Client applications can also implement knowledge-based authentication, a powerful feature that goes beyond basic password-based authentication.

---

**Note:**

Device fingerprinting and knowledge-based authentication both require Oracle Adaptive Access Manager.

---

Mobile and Social Services can be configured to require a valid device and client credential and a User Token with each application token request. This ensures

that only an authorized user can access a protected resource, and then only if the user is running an authorized application on an authorized device. Mobile and Social Services also provides easy access to User Profile Services if Mobile and Social is integrated with an LDAP compliant directory server.

---

---

**Note:**

Prior to version 11.1.2.3, Mobile and Social Services was named Mobile Services.

---

---

- *Social Identity* allows Mobile and Social to serve as the relying party when interacting with popular cloud-based identity authentication and authorization services, such as Google, Yahoo, Facebook, Foursquare, Windows Live, Twitter, and/or LinkedIn. After deploying Mobile and Social, a user is provided with multiple log-in options without the need to implement each provider individually. This allows users to access protected resources using their credentials from a trusted Identity Provider.

---

---

**Note:**

Prior to version 11.1.2.2, Social Identity was named Internet Identity Services.

---

---

- *OAuth Services* allows organizations to implement the open standard OAuth 2.0 Web authorization protocol in an Access Manager environment. OAuth enables a client to access Access Manager protected resources that belong to another user (that is, the resource owner). Applications that use Mobile and Social Services, and applications that use OAuth Services can co-exist on the same desktop or mobile device, but each requires its own separate implementation.

In addition to tight integration with Access Manager, Mobile and Social is "pre-wired" to work with other back-end Identity and Access Management Service offerings, including Oracle Adaptive Access Manager and a variety of LDAP compliant directory servers. On the front-end, Mobile and Social provides easy to use SDKs for integration of client applications on the Java, Android, and iOS platforms. The client applications then use simple REST calls to communicate with the Mobile and Social server.

---

---

**Note:**

REST (REpresentational State Transfer) is the software architectural style with which the World Wide Web has been developed. It is lightweight and especially well-suited to building web-based applications and services.

---

---

You can configure Mobile and Social Services and Social Identity to work together. For example, use Social Identity to let users authenticate with Google, Facebook, Twitter, and so on, and use Mobile and Social Services to (a) provide local authentication functionality, or (b) generate a User Token by accepting a User Identity assertion from a social Identity Provider. Mobile and Social Services can also enhance device registration security when used in conjunction with Social Identity.

**Note:**

Mobile and Social provides security layer functionality to registered applications that run on either Android or iOS devices, or in a Java SE JVM, or that communicate with the service using REST calls. If you require additional mobile functionality, ADF Mobile, a complimentary Oracle product offering, provides an application development framework for creating full-featured applications for iOS-powered devices. For more information, see the *Oracle Fusion Middleware Mobile Developer's Guide for Oracle Application Development Framework*.

The following sections contain additional information and documentation links regarding the installation and deployment of Mobile and Social.

- [Installation Combinations for Mobile and Social](#)
- [Deployment Constraints for Mobile and Social](#)
- [Enabling Mobile and Social](#)

### 48.1.1 Installation Combinations for Mobile and Social

You install Mobile and Social together with Access Manager. You can configure Mobile and Social to run by itself, or in combination with either Access Manager or Oracle Adaptive Access Manager (OAAM), or you can deploy all three together.

Depending on the software deployed alongside Mobile and Social, the available features may vary. [Table 48-1](#) provides the details.

**Table 48-1 Features in Mobile and Social Based on the Companion Services Installed**

Feature	Mobile and Social Only	Mobile and Social + Access Manager	Mobile and Social + OAAM	Mobile and Social + Access Manager + OAAM
Access Manager token support using native Access Manager authentication dialogs	Available	Available		
JWT token support for authentication and authorization	Available	Available	Available	Available
Ability to uniquely identify connecting mobile devices (Device fingerprinting)		Available		Available
Basic (limited) device security checks during device registration, access requests	Available		Available	

**Table 48-1 (Cont.) Features in Mobile and Social Based on the Companion Services Installed**

Feature	Mobile and Social Only	Mobile and Social + Access Manager	Mobile and Social + OAAM	Mobile and Social + Access Manager + OAAM
Advanced device security checks during device registration and access requests, including risk-based access controls (for example, allow or deny access based on geolocation and other device attributes)		Available		Available
Multi-step authentication support (knowledge-based authentication and one time password support)		Available		Available
Interact with a Directory server and support User Profile services	Available	Available	Available	Available
Relying party support for Internet-based Identity Providers (Facebook, Google, Twitter, LinkedIn, Yahoo)	Available	Available	Available	Available

See the *Oracle Fusion Middleware Installation Guide for Oracle Identity and Access Management* for installation details,

## 48.1.2 Deployment Constraints for Mobile and Social

The following list contains information and links regarding several Mobile and Social deployments.

- If deploying Mobile and Social together with Access Manager, both can be deployed together on the same server, either in the same domain or in separate domains. For details, see the *Oracle Fusion Middleware Installation Guide for Oracle Identity and Access Management*.
- If deploying Mobile and Social alongside Oracle Access Manager 10g or 11gR1 PS1, Mobile and Social and Oracle Access Manager need to be installed on different servers in different domains.

See "[Deploying Mobile and Social With Oracle Access Manager](#)"



---

**Note:**

If Access Manager is already installed, you cannot add Mobile and Social to an Oracle Access Management installation by extending the OAM domain. Attempting to do so will result in an error similar to the following:

```
CFGFWK-64071- the selection conflicted with templates
already installed in the domain OAM with database policy
store 11.1.1.3.0
```

---

- If deploying Mobile and Social with a WebGate, Mobile and Social can generate the Oracle Access Management token that clients need to access the WebGate-protected resources. The following restrictions apply:
  - If you deployed Oracle Access Management 11gR2 (11.1.2), Mobile and Social can generate a token that can access either an 11g WebGate or a 10g WebGate.
  - If you deployed either Access Manager 11gR1 (11.1.1) or 10g, Mobile and Social can generate an Oracle Access Management token that can access a 10g WebGate only.
- When moving Mobile and Social from a test environment to a production environment, see [Configuring Social Identity After Running Test-to-Production Scripts](#).

### 48.1.3 Enabling Mobile and Social

To leverage the Mobile and Social functionality, the service should be explicitly enabled.

Follow these steps to enable the Mobile and Social service.

1. Log in to the Oracle Access Management Console.  
The Launch Pad opens.
2. Click **Available Services** in the **Configuration** pane.  
The **Available Services** page opens.
3. Click **Enable** next to **Mobile and Social**.

## 48.2 Understanding Mobile and Social Services

Mobile and Social Services connect applications running on client devices to the security services and products available in the Oracle Identity Access Management product suite.

In addition, User Profile Services is a Mobile and Social Services feature that connects client applications to many popular LDAP compliant directory servers.

The following sections contain more detailed information regarding the Mobile and Social Services portion of Mobile and Social.

- [Mobile and Social Components](#)
- [Introducing Authentication Services and Authorization Services](#)
- [Understanding the Mobile and Social Services Authorization Flow](#)

- [Understanding Single Sign-on \(SSO\) for Mobile and Social Services](#)
- [Introducing the Mobile and Social Services Client SDK](#)
- [Introducing User Profile Services](#)

## 48.2.1 Mobile and Social Components

Mobile and Social Services consists of a server component, server-side device store, and a Mobile and Social Services Client Software Development Kit.

The details of the components as follows:

- A server component that interfaces with your backend Identity Services infrastructure. The server acts as an intermediary between supported client applications (and the users using those applications) and your backend Identity services. This arrangement decouples the client applications from the backend infrastructure so that you can modify your backend infrastructure without having to update your client programs. You can enable the Mobile and Social service to run by itself or in combination with the Access Manager service and/or the OAAM product as discussed in [Introducing Mobile and Social](#).
- A server-side device store that can store security material, such as security tokens and security information required by the OAAM Security Handler Plug-in. The server-side device store provides several benefits: It improves security because tokens managed by the server-side device store are not sent to the client application where they can be copied if the device or client app is compromised; it eliminates the need for mobile client applications to manage and synchronize security material; and finally it allows security material to be shared and synchronized among multiple client apps.
- A Mobile and Social Services Client Software Development Kit (Client SDK) is available for Android and iOS devices and Java. It is used to build authentication, authorization, and directory-access functionality into applications that run on mobile and desktop devices. The Mobile and Social Services Client SDK can also be used to build a mobile single sign-on (SSO) agent application (for Android and iOS devices only). Mobile SSO is described in [Understanding Single Sign-on \(SSO\) for Mobile and Social Services](#). The Mobile and Social Mobile and Social Services Client SDK is described in [Introducing the Mobile and Social Services Client SDK](#).

## 48.2.2 Introducing Authentication Services and Authorization Services

Authentication and Authorization Services lets you extend an existing authentication and authorization infrastructure to include mobile and non-mobile applications.

Mobile and Social Services supports the following common token types:

- A User Token grants the token bearer with the permissions associated with the person who has been authenticated.
- An Access Token grants access to a specific protected resource, such as a web resource or a URL.
- A Client Token grants access to a non-mobile hardware device, such as a web application or server application.
- A Client Registration Handle (similar to a Client Token) is also used by Mobile and Social Services. It represents a mobile client application running on a mobile

device. Mobile and Social uses the Client Registration Handle to register mobile devices, whereas non-mobile Service Providers use Client Tokens to authenticate non-mobile devices.

A mobile device is a device that runs a mobile operating system, such as the Android mobile operating system from Google or the iOS mobile operating system from Apple, while a non-mobile device is a device that runs a non-mobile operating system, such as Mac OS X, Windows 7, and Lynx desktop. Because mobile devices and non-mobile devices present different security challenges, mobile authentication and non-mobile authentication are managed separately in Mobile and Social. New mobile devices come online much more frequently and therefore require greater scrutiny, including heightened fraud detection measures.

---



---

**Note:**

A non-mobile device can use either mobile services or non-mobile services as long as the correct input is provided.

---



---

Mobile and Social supports Oracle Access Manager tokens (if Access Manager is installed with Mobile and Social) and JWT (JSON Web Token) tokens. Each token type has a corresponding mobile and a non-mobile Service Provider. Mobile and Social provides six pre-configured Authentication Service Providers:

- OAM Authentication
- Mobile OAM Authentication
- JWT Authentication
- Mobile JWT Authentication
- JWT-OAM Authentication
- Mobile JWT-OAM Authentication

[Table 48-2](#) describes the Authentication Service Providers.

**Table 48-2 Mobile and Non-Mobile Authentication Service Providers in Mobile and Social Services**

Authentication Service Provider	Description
OAMAuthentication	Lets users running a web application from a desktop device authenticate using Access Manager.
MobileOAMAuthentication	Lets users using mobile devices authenticate using Access Manager
JWTAuthentication	Lets users running a web application from a desktop device authenticate using the JSON Web Token format. JSON Web Token is a compact token format that is suitable for space-constrained environments such as HTTP Authorization headers.
MobileJWTAuthentication	Lets users using mobile devices authenticate using the JSON Web Token format.

**Table 48-2 (Cont.) Mobile and Non-Mobile Authentication Service Providers in Mobile and Social Services**

Authentication Service Provider	Description
JWTOAMAuthentication	Allows lightweight, long-duration JWT tokens to be exchanged for OAM tokens. OAM tokens provide SSO and OAM resource access to clients. This provider allows users using non-mobile applications to get a new OAM token without having to provide credentials if they have a valid, long-duration JWT token.
MobileJWTOAMAuthentication	Allows lightweight, long-duration JWT tokens to be exchanged for OAM tokens. OAM tokens provide SSO and OAM resource access to clients. This provider allows users using mobile applications to get a new OAM token without having to provide credentials if they have a valid, long-duration JWT token.

### 48.2.3 Understanding the Mobile and Social Services Authorization Flow

The Mobile and Social Services authorization flow is used if the client application implements mobile security using the Mobile and Social Client SDKs for Android, iOS, or Java, or if the client app goes through a Mobile SSO Agent app (covered later) to establish mobile security.

In this flow the client app (or the Mobile SSO Agent) collects user inputs and maintains the user session on the mobile device.

Diagrams depicting the Mobile and Social Services authorization flow appear in:

- [Registration Flow for a Mobile Device With User Authentication](#)
- [Authentication Flow for a User With a Registered Device](#)
- [Flow of REST Calls for User Authentication](#)
- [Authentication Flow for User With a Mobile Browser-Based Web App](#)

### 48.2.4 Understanding Single Sign-on (SSO) for Mobile and Social Services

Mobile Single Sign-on (Mobile SSO) lets a user run multiple mobile applications on the same device without having to provide credentials for each one.

Both native and browser-based applications can participate in Mobile SSO.

---



---

**Note:**

Mobile and Social Services apps and Mobile OAuth apps require separate SSO implementations. For information about single sign-on for Mobile OAuth applications, see [Understanding Mobile OAuth Services Server-Side Single Sign-on](#).

---



---

## Understanding the Mobile SSO Agent App

A special app installed on a mobile device can be designated as a Mobile SSO Agent. This app serves as a proxy between the remote Mobile and Social server and the other apps on the device that need to authenticate with the back-end Identity services. The Agent can either be a dedicated agent (that is, an app that serves no other purpose), or a business (client) app that also provides agent functionality.

---

---

**Note:**

Before an app can use the Mobile SSO agent app to authenticate with the Mobile and Social server, you must configure the app as either a Mobile SSO Agent or Client on the server. For more information about configuring Mobile and Social Services security for Mobile SSO, see [Defining Service Domains](#).

---

---

The Mobile SSO Agent handles device registration and advanced authentication schemes (including multi-factor authentication and one time password authentication), so this functionality does not have to be built into each mobile application. When the Mobile SSO Agent is present, user credentials are never exposed to the mobile business applications. The Mobile SSO Agent and SSO Client interact as follows:

- The SSO Client app sends the device registration request, the application registration request, and the User Token request to the SSO Agent.
- The SSO Agent makes the necessary acquisitions on behalf of the SSO Client.
- The SSO Client app then requests any Access Tokens it needs using the registration handle and User Token.
- The SSO Agent app stores tokens and security material on behalf of the mobile SSO Client, similar to the server-side device store.

A browser-based business app can also be configured to use a Mobile SSO Agent for authentication. If that is the case, launching a browser-based business app invokes the Mobile SSO Agent and causes the agent to collect a user name and password, and send them to the Mobile and Social server. If the business app and the agent are authorized for SSO, the Mobile and Social server authorizes access. The agent then requests an Access Token for the resource (on behalf of the business app) and redirects the browser to the URL of the business app with the Access Token included in the headers.

From the user's perspective, native and browser-based apps open on the device without asking the user to provide credentials. If the agent is not installed on the mobile device, or if the business app is not approved for Mobile SSO, the user will have to directly and independently send his or her credentials to the Mobile and Social server with each and every app that is launched.

The Mobile SSO Agent can time-out idle sessions, manage global logout for all apps, and assist in device selective wipe outs. Furthermore, it supports basic offline authentication. The agent one-way encrypts user passwords for local storage. During offline authentication, the agent validates the user name and password with the locally stored version. The agent then enforces all session idle time-outs and local password expiration policies.

When using a mobile SSO agent, apps open on the device without asking the user to provide credentials. If the agent is not installed on the mobile device, or if the business

app is not approved for Mobile SSO, the user will have to directly and independently send his or her credentials to the Mobile and Social server with each and every app that is launched.

Oracle does not provide a pre-built Mobile SSO Agent, however, documentation is provided so that you can build a Mobile SSO Agent app using the Mobile and Social Services Client SDK for Android or iOS. For more information about creating a Mobile SSO Agent app, refer to either the Android or the iOS Mobile and Social Services SDK documentation in the *Oracle Fusion Middleware Developer's Guide for Oracle Access Management*.

---



---

**Note:**

The Mobile SSO Agent is only supported on Android and iOS devices.

---



---

## 48.2.5 Introducing the Mobile and Social Services Client SDK

The Mobile and Social Services Client SDK contains individual SDKs for Android and iOS devices, and for Java Virtual Machines (JVMs).

[Table 48-3](#) documents each Mobile and Social Services Client SDK feature and the software on which it works.

**Table 48-3** *Android, iOS, and Java Features of the Mobile and Social Services Client SDK*

Feature	Android	iOS	Java
Build a mobile application that can acquire Client Registration Handle, User, and Access Tokens through a Mobile and Social Server	4	4	
Build a desktop application that can acquire Client, User, and Access Tokens through a Mobile and Social Server			4
Interact with a Directory server and implement User Profile Services	4	4	4
Create a mobile single sign-on (SSO) application	4	4	

## 48.2.6 Introducing User Profile Services

User Profile Services makes it possible to build an application that lets a user in your organization access the User Profile Services from mobile devices.

User Profile Services allows Web, mobile, and desktop applications to perform a variety of LDAP compliant directory server tasks including:

- Create, read, update, and delete functionality for users and groups
- Search functionality

- Org (organization) chart reporting functionality

Towards this end, the Mobile and Social server can interface with many popular LDAP compliant directory servers including:

- Microsoft Active Directory
- Novell eDirectory
- Oracle Directory Server Enterprise Edition
- Oracle Internet Directory
- Oracle Unified Directory
- Oracle Virtual Directory
- Open LDAP
- WebLogic Server Embedded LDAP

Refer to the *Oracle Fusion Middleware Developer's Guide for Oracle Access Management* for sample code that demonstrates how to use the SDK for User Profile Services.

---

---

**Note:**

Any device capable of HTTP communication can use User Profile Services by sending REST calls to the Mobile and Social server. See "Sending Mobile and Social REST Calls With cURL" in the *Oracle Fusion Middleware Developer's Guide for Oracle Access Management*.

---

---

## 48.3 Understanding the Mobile and Social Services Processes

When a user tries to access a protected resource, Mobile and Social requires either a Client Token (if the user is connecting through a server or a computer which securely stores client credentials) or a Client Registration Handle (if the user is using a mobile device). Client devices (including mobile devices) and client applications must register with Mobile and Social before access to protected resources can be granted.

---

---

**Note:**

Applications are also typically configured to require a User Token and an Access Token.

---

---

Client applications running on mobile devices follow this high-level authentication process before the mobile application can access a protected resource.

1. The user enters a user name and password at the application login screen and authenticates with the Mobile and Social server.
2. If a mobile device has not previously registered with the Mobile and Social server, the server sends the mobile device a Client Registration Handle after authenticating the user.
3. The Client Registration Handle is submitted back to the Mobile and Social server to get a User Token.

4. The Client Registration Handle and User Token are submitted back to the Mobile and Social server to get an Access Token.

A non-mobile application can also make use of Authentication Services provided by Mobile and Social Services. In such cases, a Client Token takes the place of the Client Registration Handle. After the Client Token is obtained, a User Token and Access Token can be requested as documented above. Additional scenarios are documented in these sections.

- [Registration Flow for a Mobile Device With User Authentication](#)
- [Authentication Flow for a User With a Registered Device](#)
- [Flow of REST Calls for User Authentication](#)
- [Authentication Flow for User With a Mobile Browser-Based Web App](#)
- [Authorization Using the Mobile OAuth Authorization Flow](#)

### 48.3.1 Registration Flow for a Mobile Device With User Authentication

When the mobile device attempting to access a protected resource has not previously registered with Mobile and Social, a Mobile SSO Agent must be installed.

The registration authentication process is documented in the following flow. [Figure 48-1](#) and [Figure 48-2](#) follow the text and illustrate the process.

1. The user launches an application on a mobile device.
2. The application redirects the user to the Mobile SSO Agent.
3. The Mobile SSO Agent displays a login page.
4. The user enters a user name and password.
5. The Mobile SSO Agent sends the user name and password to the Mobile and Social server along with the device attributes and application ID.
6. The Mobile and Social server forwards the user name and password to Access Manager which authenticates the user.
7. The Mobile and Social server sends device attributes and other authentication results to the OAAM Mobile Security Handler Plug-in which executes the policy stored on the OAAM server.

---

**Note:**

OAAM has two registration flows—active and passive. The active flow prompts the user with a challenge before allowing the device registration process to proceed. The passive flow continues without challenging the user.

---

The OAAM Security Handler Plug-in creates two security handles (snippets of data that Mobile and Social stores with either the Mobile SSO Agent or the business application itself). Each handle stores a name, value, and expiration timestamp.

- The `oaam.device` handle represents the mobile device. (Different client applications on the same device all have the same device handle value.)



OAAM uses this handle as a key to retrieve the full device profile stored in the OAAM database. This handle has a relatively long life span.

- The `oaam.session` handle represents an OAAM login session for a client application. (Each client application on a device has a unique session handle value.) OAAM uses this handle as a key to retrieve details about the OAAM session stored in the OAAM database. When the user logs out from the client application, the `oaam.session` handle is removed.
8. The Mobile and Social server returns the Mobile Client Registration Handle and OAAM device and session handles to the Mobile SSO Agent.
  9. The Mobile SSO Agent gets a User Token by passing the Client Registration Handle and OAAM device handles that it previously received to the server.
  10. The Mobile SSO Agent requests an Access Token from Access Manager. The request contains the Client Registration Handle and OAAM device handles. See [Figure 48-2](#).

**Figure 48-1 First Time Device/Application Registration and Authentication Process**

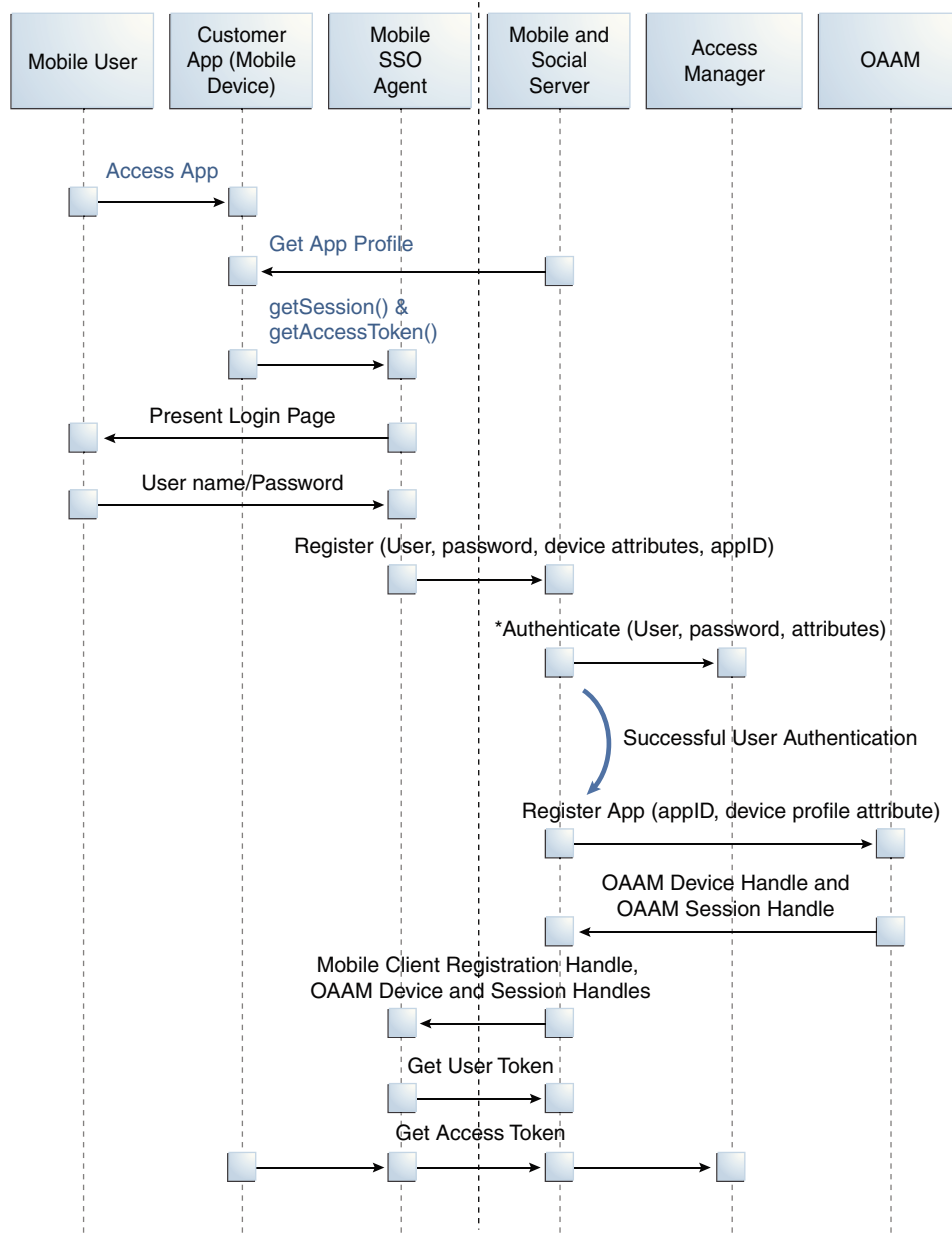

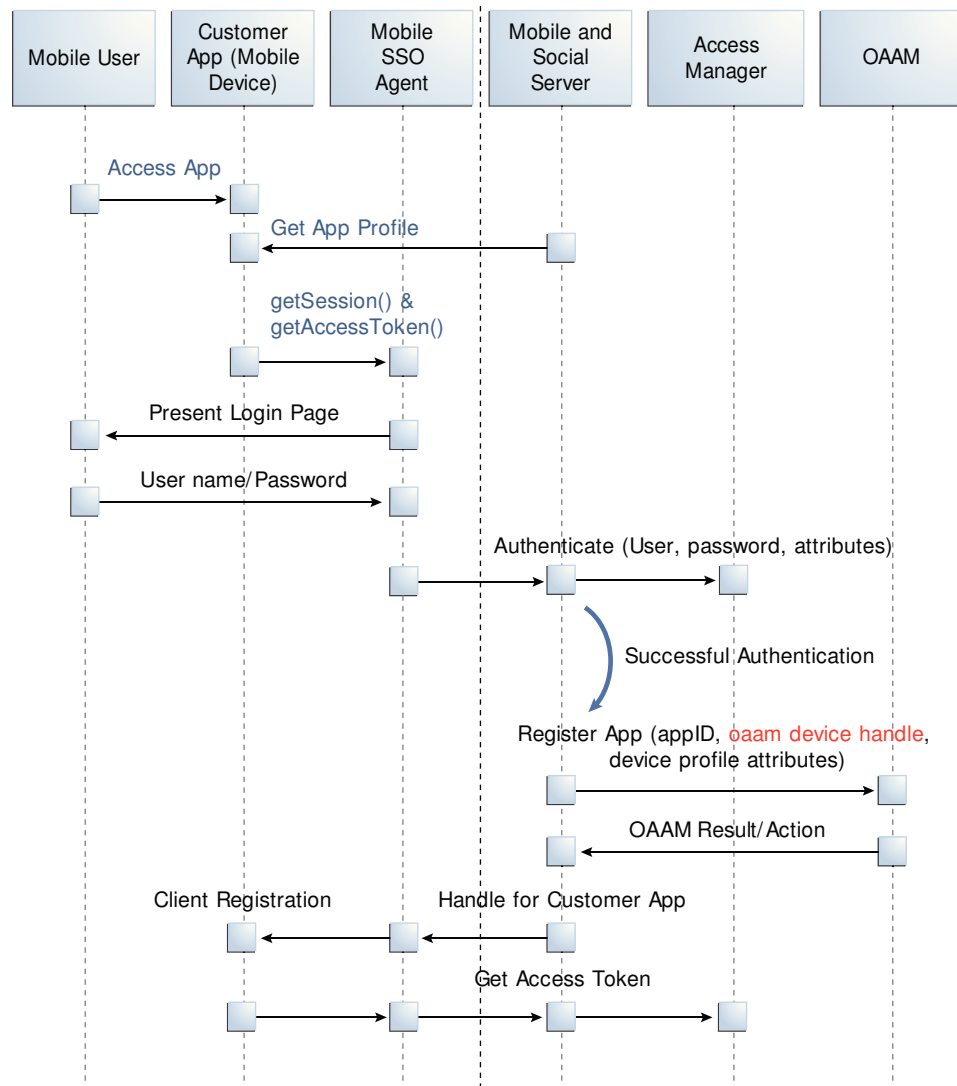
**Figure 48-2 Mobile SSO Agent Requests Access Token from Access Manager**

### 48.3.2 Authentication Flow for a User With a Registered Device

When a user with a mobile device (already registered with Mobile and Social) is launching a Mobile and Social compatible business application, the Mobile SSO Agent is already installed and the user needs to access a protected resource that requires an Access Token.

The business application must first acquire the User Token before it can request the Access Token. The accompanying figures (Figure 48-3 and Figure 48-4) illustrate the process.

1. The user launches the business application on a mobile device.
2. The business application asks the Mobile SSO Agent for a User Token and one of the following occurs.
  - a. If a valid User Token exists in the local credential store, the Mobile SSO Agent returns it to the business application. The business application inserts the User Token into a direct request to the Mobile and Social server for the Access Token. The flow completes when the business application uses the Access

Token returned by the server to access the protected resource (as in [Figure 48-3](#)).

**Figure 48-3 Mobile SSO Agent Has Valid Access Token in Credential Store**

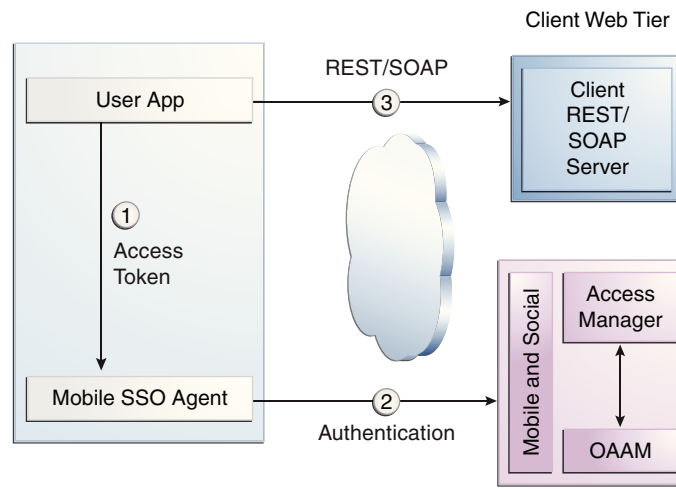

- b. If a valid User Token does not exist in the local credential store, the login flow continues (as in [Figure 48-4](#)).
3. The Mobile SSO Agent presents a login page and the user enters a user name and password.
4. The Mobile SSO Agent sends the user name, password, and Client Registration Handle to the Mobile and Social server. (Step 2 in [Figure 48-4](#)).
5. The Mobile and Social server validates the Client Registration Handle, authenticates the user credentials (with either the JWT token service or the Access Manager token service), invokes OAAM for risk analysis and then returns the User Token to the Mobile SSO Agent. (Step 3 in [Figure 48-4](#)).
6. The Mobile SSO Agent stores a copy of the user token in its local credential store and returns the User Token to the business application. (Step 4 in [Figure 48-4](#)).
7. The business application uses the User Token to make a direct request to the Mobile and Social server for the Access Token. (This step is not shown in the diagram.)
8. The Mobile and Social server returns the Access Token to the Mobile SSO Agent.
9. The business application uses the Access Token to make calls to the resource protected by Access Manager or Oracle Enterprise Gateway (OEG). (Step 5 in [Figure 48-4](#)).

**Figure 48-4 Mobile SSO Agent Does Not Have Valid Access Token in Credential Store**

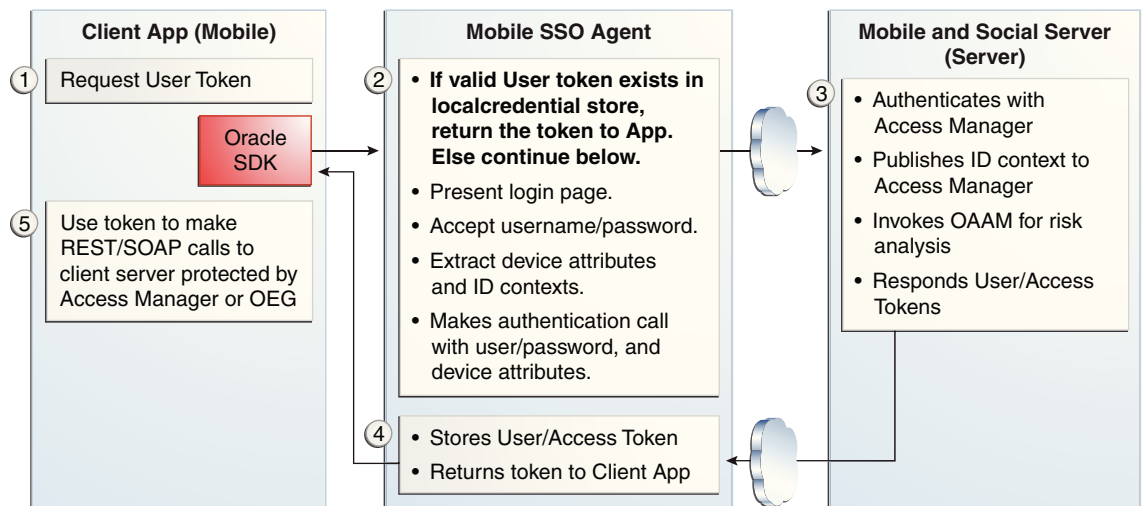

### 48.3.3 Flow of REST Calls for User Authentication

An application running on a mobile device interfaces with the Mobile SSO Agent, which communicates with the Mobile and Social server using REST calls.

The server interfaces with Access Manager and OAAM as needed and returns the necessary tokens to the Mobile SSO Agent (again using REST calls). The agent forwards the tokens back to the application, which can now access the protected resource using either REST or SOAP calls. The process is documented in the following flow. [Figure 48-5](#) follows the text and illustrates the process.

1. The user launches an application on a mobile device.
2. Because the client application needs to access a resource protected by Access Manager, the client application asks the Mobile SSO Agent for an Access Token.
3. The Mobile SSO Agent gets the Application Profile from the Mobile and Social server.
4. The Mobile SSO Agent prompts for a user name and password.
5. The Mobile SSO Agent sends the user name and password to the Mobile and Social server along with the device attributes and application ID.
6. The Mobile and Social server registers the device and authenticates the user.
7. The server returns an Access Token to the Mobile SSO Agent.
8. The Mobile SSO Agent saves the hashed password in its local credential store.
9. The Mobile SSO Agent passes the Access Token to the client application.
10. The client application accesses the protected resource by presenting the Access Token.

**Figure 48-5 User Authentication Using REST**

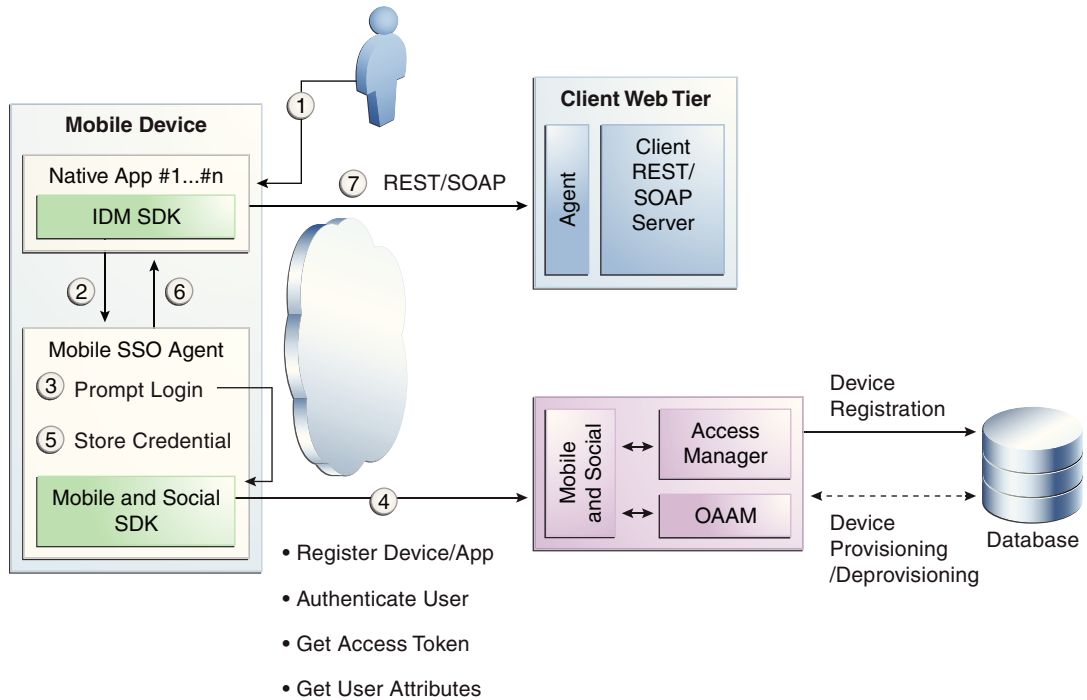

### 48.3.4 Authentication Flow for User With a Mobile Browser-Based Web App

When a user with a Mobile and Social registered mobile device is launching a Mobile and Social compatible browser-based web application, the Mobile SSO Agent is installed.

The legacy authentication process is documented in the following flow. [Figure 48-6](#) follows the text and illustrates the process.

1. The user opens a URL in a web browser on a mobile device.
2. The application web server redirects the browser to Access Manager.
3. Access Manager sends the web browser a URL redirect.
4. The web browser responds to the redirect by launching the Mobile SSO Agent.  
 If the agent is not installed, a link with instructions to install the Mobile SSO Agent application is displayed.
5. The Mobile SSO Agent displays the User login page.
6. The user enters a user name and password.
7. The Mobile SSO Agent sends the user name, password, and Client Registration Handle to the Mobile and Social server. (This step is not shown in the diagram.)
8. The Mobile and Social server validates the Client Registration Handle, authenticates the credentials with Access Manager, publishes the ID context to the Access Manager server, and invokes OAAM for risk analysis.

9. Access Manager returns a User Token or an Access Token to the Mobile and Social server which, in turn, returns the User Token or the Access Token to the Mobile SSO Agent. (This step is not shown in the diagram.)
10. The Mobile SSO Agent directs the browser to the Mobile and Social server where it injects a cookie.
11. The Mobile SSO Agent sends the web browser a URL redirect and an Access Token.
12. The mobile web browser responds to the redirect and opens the original web URL because the access request now includes an Access Token.
13. The application web server sends the requested pages to the mobile web browser.

**Figure 48-6 Authenticating User From Browser-based Web App on Registered Mobile Device**

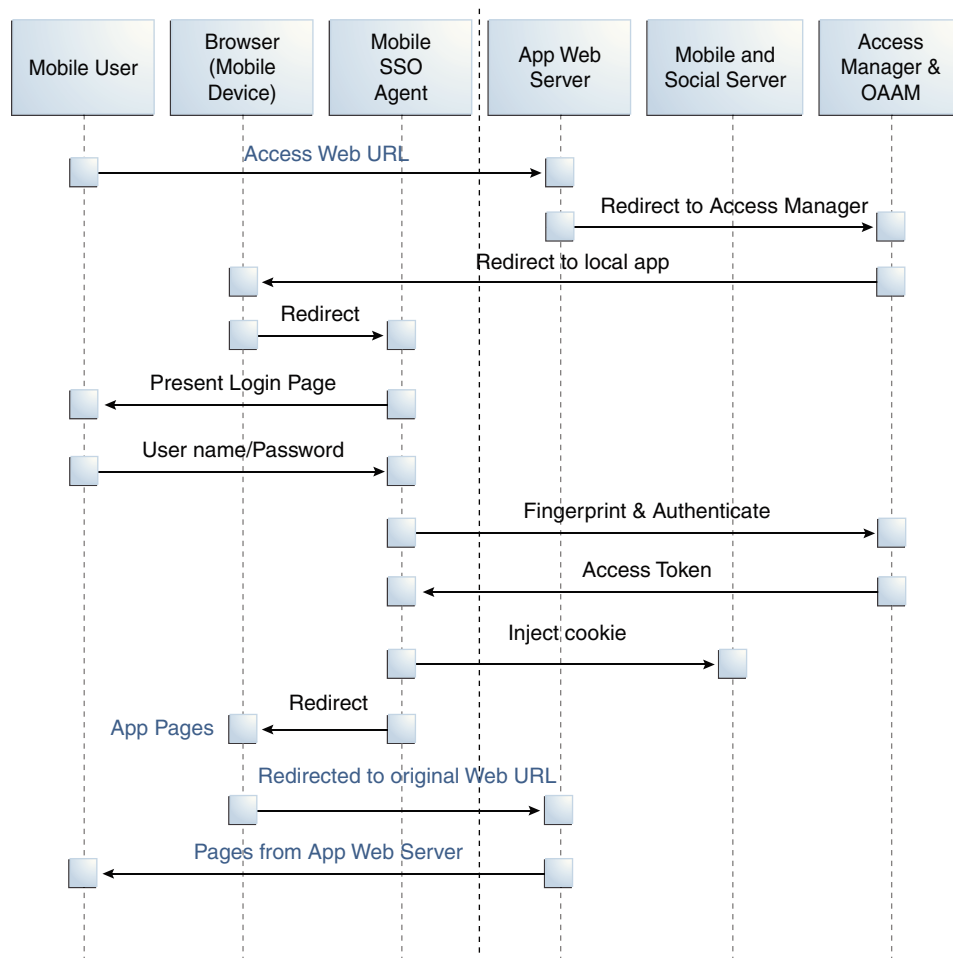

### 48.3.5 Authorization Using the Mobile OAuth Authorization Flow

Interactions between a mobile app and the Oracle Access Management OAuth service in the context of Mobile and Social Services describe the Mobile OAuth authorization flow.

To understand the difference between the legacy authorization flow and the Mobile OAuth authorization flow, see [Understanding the Mobile and Social Services Authorization Flow](#).

For a detailed look at the OAuth authorization flow in the context of the OAuth Service, see [Understanding OAuth Services Authorization for Mobile Clients](#).

1. The mobile app requests a client verification code by sending a device token.

The OAuth service returns the client verification code. If the APNS/GCM option is enabled, the OAuth service returns half of the code using push notification, and the other half over HTTPS. Push notification provides an extra level of assurance for confirming the identity of the application and device.

2. The mobile app requests an authorization code by sending device claims and the client verification code.

The OAuth service:

- Authenticates the user
- Requests the user's consent to register the app (optional)
- Invokes OAAM for risk analysis
- Returns the authorization code using push notification (optional) and HTTPS

3. The mobile app requests a Client Token by sending the authorization code and device claims.

The OAuth service returns the Client Token using push notification (optional) and HTTPS.

4. The mobile app requests an Access Token by sending the Client Token, the authorization code, and the device claims.

The OAuth service returns the Access Token.

5. The mobile app requests access to the protected resources using the Access Token. (Not shown in the diagram.)

The resource server returns the protected resources to the client application. (Not shown in the diagram.)



Figure 48-7

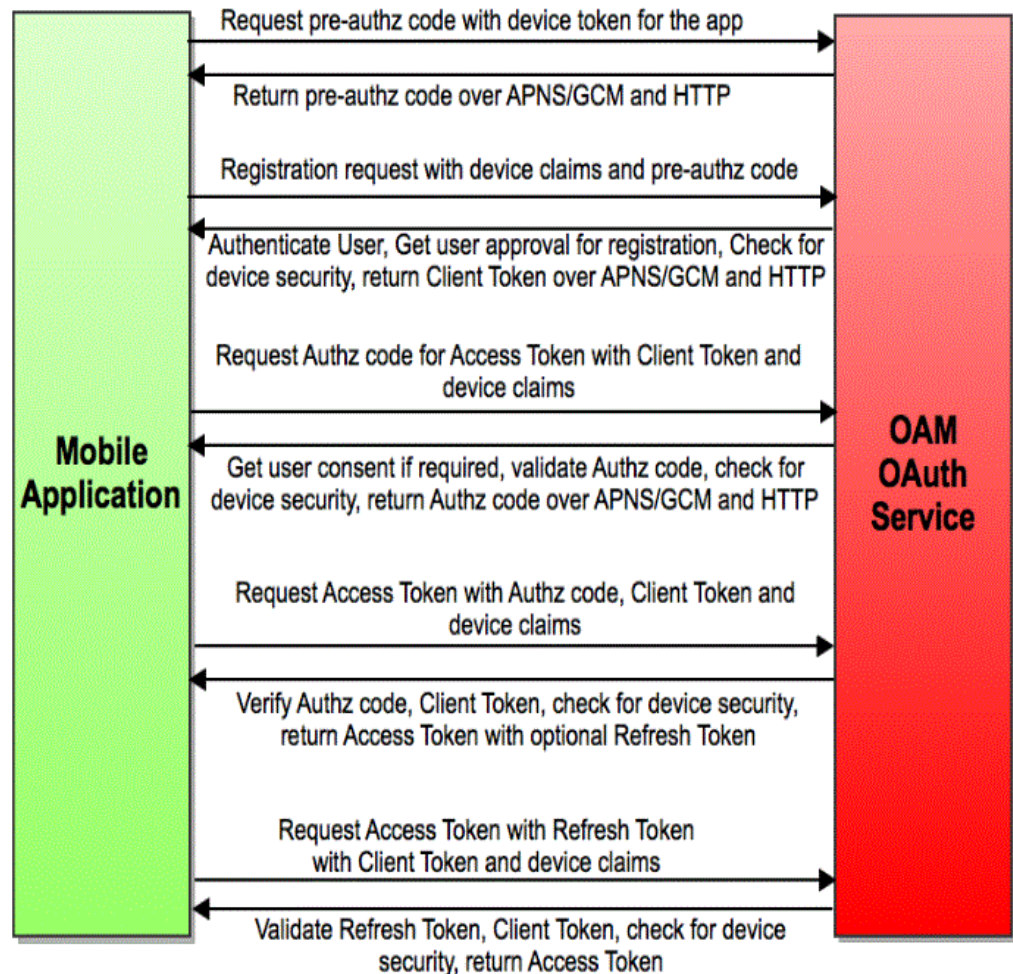

## 48.4 Using Mobile and Social Services

Practical aspects of using and operating Mobile and Social Services include:

- [Protecting the Mobile Client Registration Endpoint](#)
- [Token Requirements for Mobile and Social Server](#)
- [Protecting User Profile Services And Authorization Services](#)
- [How Mobile and Social Services Work with Oracle Access Manager](#)
- [How Mobile and Social Services Work with Oracle Adaptive Access Manager Services](#)

### 48.4.1 Protecting the Mobile Client Registration Endpoint

A mobile device attempting to access a protected resource must register with the Mobile and Social server as the server rejects anonymous requests sent to its registration endpoint.

Additionally, each Service Domain should be configured to require either a User password or a User Token to register an application. The following is a sample registration endpoint for mobile clients and mobile applications:

```
https:// host : port /idaas_rest/rest/mobileservice1/register
```

When registering with the Mobile and Social server, client applications using either the Java Client SDK or the REST API must present valid credentials to the server using one or more of the following schemes:

- HTTP Basic Authentication
- User ID and Password (UIDPASSWORD)
- OAM Token Authentication

Client applications using the Android or iOS SDK will acquire a Client Registration Handle which uses the UIDPASSWORD authentication scheme to secure registration.

## 48.4.2 Token Requirements for Mobile and Social Server

The Android, iOS, and Java SDKs will send the tokens, credentials, and other data required by the Mobile and Social server.

[Table 48-4](#) describes the tokens required and returned based on the client device or application.

---



---

**Note:**

For a detailed look at the credentials, see “Mobile and Social Services REST Reference: Authentication and Authorization” in the “Sending Mobile and Social REST Calls With cURL” chapter of the *Oracle Fusion Middleware Developer’s Guide for Oracle Access Management*.

---



---

**Table 48-4 Token Requirements for the Mobile and Social Server**

Device or App Type Seeking to Register	Token(s), Credentials, and/or Data Required by the Mobile and Social Server	Type of Token Returned
Non-Mobile Device (Unregistered)	An ID and password associated with a client application sent over HTTPS.	Client Token
Mobile SSO <i>Agent</i> App	<ul style="list-style-type: none"> <li>• A user ID and password sent over HTTPS.</li> <li>• Device profile data for the Mobile Device.</li> <li>• The name of the application (that is, the Client ID).</li> </ul> <p><b>Note</b> - An Administrator must also add the name of the mobile SSO Agent to a Service Domain.</p>	Client Registration Handle

**Table 48-4 (Cont.) Token Requirements for the Mobile and Social Server**

Device or App Type Seeking to Register	Token(s), Credentials, and/or Data Required by the Mobile and Social Server	Type of Token Returned
Mobile SSO <i>Client</i> App (For example, a business application that uses the Mobile SSO Agent App to register with Mobile and Social.)	<ul style="list-style-type: none"> <li>• One of the following: A user ID and password sent to the Mobile and Social server over HTTPS.</li> <li style="text-align: center;">- or -</li> <li>• A User Token.</li> <li>• Device profile data for the Mobile Device.</li> <li>• The name of the application (that is, the Client ID).</li> </ul> <p><b>Note</b> - An Administrator must also add the name of the mobile SSO Client application to a Service Domain.</p> <ul style="list-style-type: none"> <li>• The <code>oaam.device</code> handle (if Mobile and Social is integrated with OAAM).</li> <li>• Mobile SSO Client Registration Handle (previously obtained for the SSO agent), if the SSO Client application tries to register through the SSO agent application.</li> </ul>	Client Registration Handle

### 48.4.3 Protecting User Profile Services And Authorization Services

You can choose to protect User Profile Services and Authorization Services when configuring a Mobile and Social Services Service Domain.

**User Profile Services** - Configure User Profile Services security by making the following selections for the Service Profile:

- Choose the Authentication Service Provider (OAMAuthentication, MobileOAMAuthentication, JWTAuthentication, Mobile JWT Authentication, Social Identity Authentication, and so on)
- Protect the service by requiring a "Secured Application" security token and a "Secured User" security token
- Set the "Allow Read" and "Allow Write" options

**Authorization Services** - Configure Authorization Services security by making the following selections for the Service Profile:

- Choose the Authentication Service Provider (OAMAuthentication, MobileOAMAuthentication, JWTAuthentication, Mobile JWT Authentication, Social Identity Authentication, and so on)
- Protect the service by requiring a "Secured Application" security token and a "Secured User" security token.

#### 48.4.4 How Mobile and Social Services Work with Oracle Access Manager

Developers can quickly create applications that access resources protected by either Oracle Access Management Access Manager, or the 10g or 11gR1 PS1 (11.1.1.5) versions of Oracle Access Manager.

The Mobile and Social SDK handles authentication programatically after it collects user credentials using the credential collection interface. The SDK then uses the Mobile and Social REST interfaces to authenticate the user with the token service configured for the application. For more information about the Mobile and Social Services' authentication flow with Access Manager, see [Registration Flow for a Mobile Device With User Authentication](#).

#### 48.4.5 How Mobile and Social Services Work with Oracle Adaptive Access Manager Services

Oracle Adaptive Access Manager (OAAM) can be used to make runtime authentication decisions, such as blocking authentication if the user is authenticating from an unauthorized country or location.

The following functionality is also supported.

- Multi-part login flows - for example, OAAM can challenge the user with knowledge-based authentication questions, or require the user to authenticate using one-time password (OTP) functionality if OAAM detects a risky or unusual usage pattern (using the device at unusual hours or if the user is geographically distant from the place where authentication last took place).
- Check device attributes (such as the MAC Address assigned to a device) and verify that the device is not jail broken. Based on device attributes, OAAM can allow or deny access.
- Device-selective wipeouts are also an option when using OAAM together with Mobile and Social.
- Based on registered device info, OAAM can white-list or black-list specific devices.

For more information about using Mobile and Social with OAAM, see [Configuring Mobile and Social Services for Oracle Adaptive Access Manager](#).

### 48.5 Understanding Social Identity

Social Identity lets Mobile and Social serve as the relying party (RP) when interacting with cloud-based Identity Authentication and Authorization Services, such as Google, Yahoo, Facebook, Twitter, Windows Live, Foursquare and/or LinkedIn.

Allowing users to log in to a protected resource using their credentials from a trusted Identity Provider is a convenience for the user. By deploying Mobile and Social, you can provide users with a convenient multiple log-in option without the need to implement each Provider individually. Users can use their credentials from cloud-based identity services to log in to any of the following application types.

- *Web applications that run on Java-compliant application servers.* To add Social Identity functionality to a Web application, a developer connects the Web application to the Mobile and Social server using the Social Identity Client SDK. For details, see

the "Developing Applications Using the Social Identity Client SDK" chapter in the *Oracle Fusion Middleware Developer's Guide for Oracle Access Management*.

- *Applications protected by either Access Manager, or the 10g or 11.1.1.5 versions of Oracle Access Manager.* Applications protected by either the Access Manager service in the Oracle Access Management product, or the 10g or 11gR1 PS1 versions of Oracle Access Manager can be configured to work with Social Identity without using an SDK. For details about the authentication flow, see [Authentication Flow for a User With Access Manager and Social Identity](#).
- *Mobile applications running Android or iOS.* Mobile applications running Android or iOS can be configured to authenticate with an Social Identity Provider. To connect to the Mobile and Social server, Android and iOS applications use the Mobile and Social Services SDKs for those platforms. A separate SDK is not required.

Social Identity provides services for Identity Providers that support the following standards:

- OpenID version 2.0
- OpenID Simple Registration Extension 1.0
- Open ID Attribute Exchange Extension 1.0
- OpenID Provider Authentication Policy Extension 1.0
- OAuth 1.0 and 2.0

Native support for the Identity Providers listed in [Table 48-5](#) is provided by Mobile and Social after installation.

**Table 48-5 Identity Providers That Mobile and Social Natively Supports**

Identity Provider	Supported Protocol
Facebook	OAuth 2.0
Google	OAuth 2.0
LinkedIn	OAuth 2.0
Twitter	OAuth 2.0
Yahoo	OpenID 2.0
Foursquare	OAuth 2.0
Windows Live	OAuth 2.0

Java programmers can add relying party support for additional OpenID and OAuth Identity Providers by implementing a Java interface and using the Mobile and Social console to add the Java class to the Mobile and Social deployment. For more information, see the "Extending the Capabilities of the Mobile and Social Server" chapter in the *Oracle Fusion Middleware Developer's Guide for Oracle Access Management*.

## 48.6 Understanding Social Identity Processes

Various flows govern the authentication scenarios involving the user, the Mobile and Social server (the relying party), and related parties:

- [Basic Flow for Social Identity Authentication](#)
- [Authentication Flow for a Returning User With a Local Account](#)
- [Authentication Flow for a New User With No Local Account](#)
- [OAuth Flow For Access Token Retrieval](#)
- [Authentication Flow for a User With Access Manager and Social Identity](#)
- [Authentication Flow for a Local User](#)

### 48.6.1 Basic Flow for Social Identity Authentication

The following scenario documents the basic authentication process when using Social Identity.

1. A user requests access to a protected resource and is redirected to Mobile and Social.
2. Mobile and Social (RP) asks the user if they would like to log in using their credentials from, for example, Google (the Identity Provider).
3. Mobile and Social redirects the user to a Google login page where a user name and password is entered.
4. Google verifies the credentials and redirects the user back to Mobile and Social. At the same time the Identity Provider returns identity attributes to Mobile and Social based on its configuration.

If the user does not have an account with your organization, the user can be prompted to register for one; the registration form will be prepopulated with the information that the Identity Provider returns.

---

---

**Note:**

In the case of Access Manager, a user **MUST** register locally, otherwise access is not given. If not using Access Manager, the user is redirected to the protected resource and allowed access even if they don't register. For details, see [How Social Identity Works with Oracle Access Manager](#).

---

---

### 48.6.2 Authentication Flow for a Returning User With a Local Account

The local Identity repository determines that the user already has a local account. Consequently Mobile and Social does not prompt to create one.

This scenario describes the authentication flow between the User, the Mobile and Social server (the relying party), the Identity Provider, and the local user authentication service (represented by Local Auth and ID Repository in the diagram). [Figure 48-8](#), following the text, illustrates the process.

1. The user opens a URL for a protected resource in a web browser and the Mobile and Social server presents the user with a login page and a menu of Identity Providers (Google, Yahoo, Facebook, Windows Live, Foursquare, Twitter, or LinkedIn) from which to choose.
2. The user chooses an Identity Provider.

3. The Mobile and Social server redirects the user to the selected Identity Provider and a login page is displayed.
4. The user enters a user name and password and, upon authentication, the Identity Provider sends the Mobile and Social server an authentication assertion.
5. The Mobile and Social server checks with the Identity repository to see if the user has a local account.

The Identity repository could be a directory server, a database, Oracle Identity Manager, or similar. The user is determined to be a User with a local account:

- If a mobile application or a directly-integrated Web application is authenticating with Mobile and Social, the Mobile and Social server sends an authentication assertion to the user's browser.
  - If an application protected by Access Manger is authenticating, Access Manager creates the session for the user only if the user has a local account. (Newly registered users count as local account holders.)
6. The user's browser sends the authentication assertion sent by Mobile and Social to the protected resource's Access Management Service.
  7. The Access Management Service carries out additional authentication steps as needed.
  8. The Access Management Service allows the user access to the protected resource.

**Figure 48-8 Authenticating a Returning User with a Local Account**

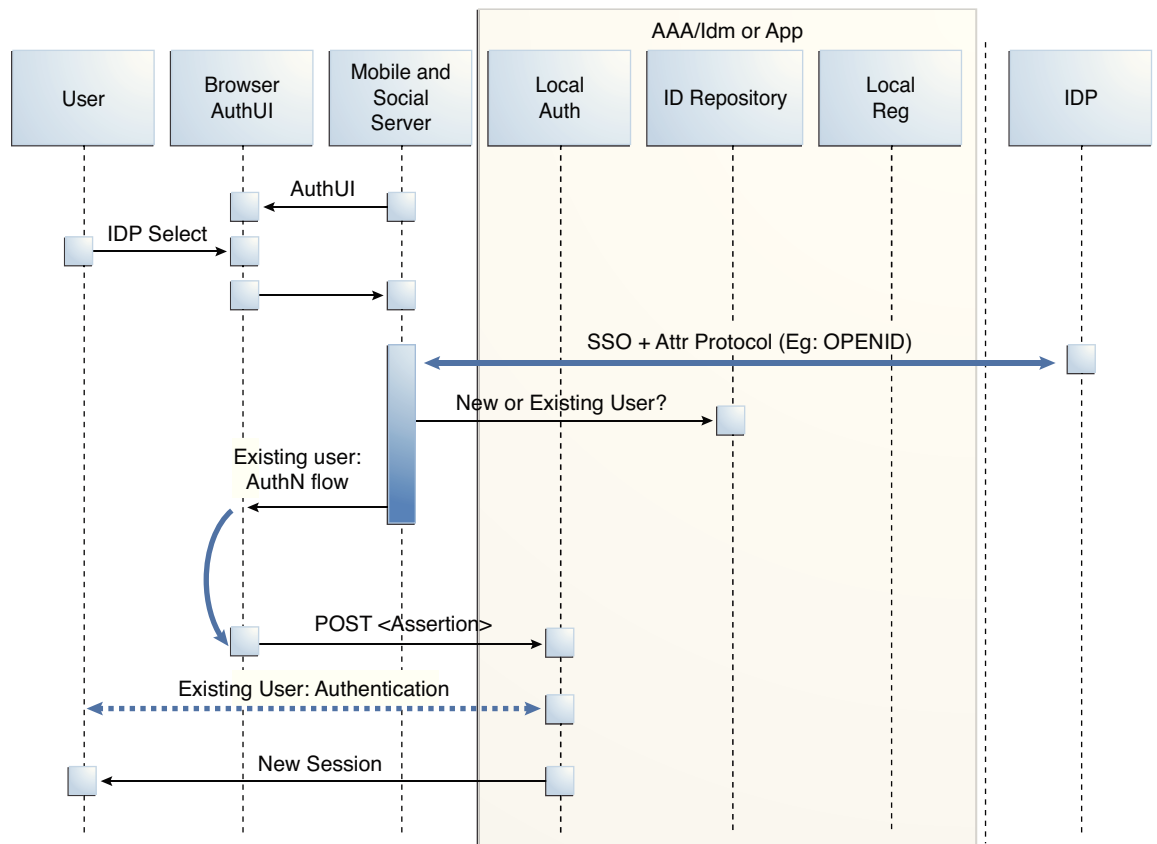

### 48.6.3 Authentication Flow for a New User With No Local Account

For a user who does not have a local account, the Mobile and Social prompts to create one.

This scenario describes the authentication flow between the User, the Mobile and Social server (the relying party), the Identity Provider, and the local User authentication service (represented by Local Auth and ID Repository in the diagram). [Figure 48-9](#), following the text, illustrates the process.

1. The user opens a URL for a protected resource in a web browser and the Mobile and Social server (RP in the diagram) presents the user with a login page and a menu of Identity Providers (Google, Yahoo, Facebook, Twitter, or LinkedIn) from which to choose.
2. The user chooses an Identity Provider.
3. The Mobile and Social server redirects the user to the selected Identity Provider which displays a login page.
4. The user enters a user name and password and, upon user authentication, the Identity Provider sends the Mobile and Social server an authentication assertion.
5. The Mobile and Social server checks with the Identity repository to see if the User has a local account.

The Identity repository could be a directory server, a database, Oracle Identity Manager or similar. The user is determined to be a user who does not have a local account. Mobile and Social proceeds as follows:

- If the Identity Provider uses the Open ID protocol, the Mobile and Social server retrieves the user's profile attributes by processing data in the previously obtained authentication assertion.
  - If the Identity Provider uses the OAuth protocol, the Mobile and Social server makes a separate HTTP call to the Identity Provider with the previously obtained Access Token to retrieve the user's profile attributes.
6. The Mobile and Social server sends a new user registration form to the user's browser.

The registration form is pre-populated with the user profile attributes sent by the Identity Provider in the previous step.

7. The user completes the registration form and sends it to which interfaces with the user registry (either a directory server or Oracle Identity Manager) to create the account.

In cases where an Access Token is retrieved from the Identity Provider, the Access Token is also returned to the client application by way of Mobile and Social.

8. The Access Management Service for the client application carries out additional authentication steps as needed.
9. The Access Management Service allows the user access to the protected resource.

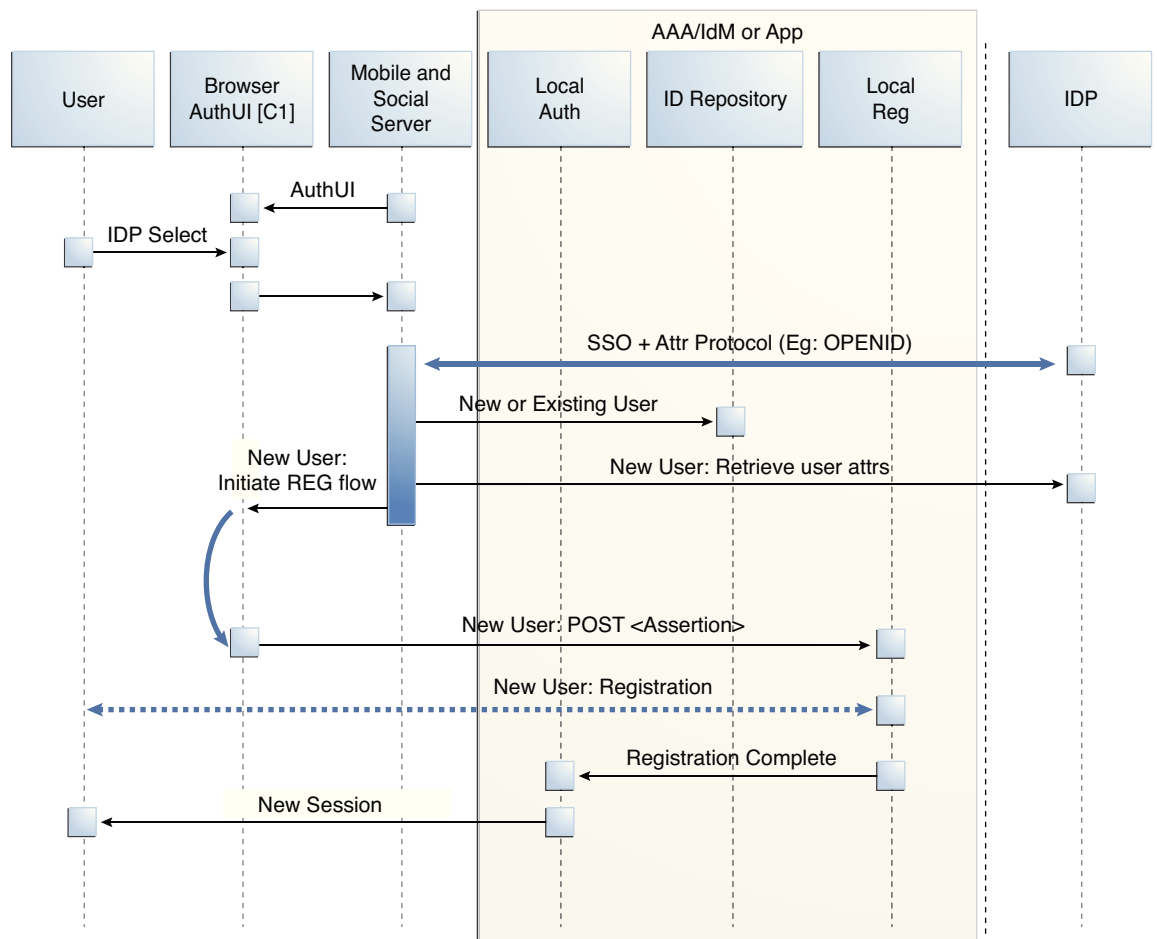

**Figure 48-9 Authenticating a New User with No Local Account**

#### 48.6.4 OAuth Flow For Access Token Retrieval

OAuth authentication and Access Token retrieval flow is between the User, the relying party, and OAuth Identity Provider. The server interfaces with the OAuth Identity Provider to get an authorization code and Access Token to access a resource protected by the OAuth Identity Provider.

This section provides supplemental detail about the OAuth authentication and Access Token retrieval flow between the User, the Mobile and Social server (the relying party), and an OAuth Identity Provider. (Facebook, Foursquare, and Windows Live use the OAuth 2.0 protocol, and LinkedIn and Twitter use the OAuth 1.0 protocol.) The Client application in this scenario could be either a Web application running on a Java-compliant application server, or a mobile application. [Figure 48-10](#), following the text, illustrates the process.

1. The user opens the client application which returns a protected web page to the user's browser.
2. The user attempts to open the protected resource on the client application.
3. The client application asks the Mobile and Social server for an Access Token so that the user can access the protected resource.

If Mobile and Social has the valid Access Token in its cache, it will forward the Access Token to the client application and the authentication scenario would skip to step 10. This flow assumes Mobile and Social does not have the Access Token in its local cache.

4. Because the Access Token is not in its local cache, on behalf of the user, Mobile and Social initiates an authorization request (utilizing HTTP headers to embed an OAuth Client ID, scope information, and a redirect URL) with the OAuth Identity Provider.
5. The OAuth Identity Provider displays a login page.
6. The user enters a user name and password into the OAuth Identity Provider login page and gives consent to the Identity Provider to provide the user's profile attributes to the Mobile and Social server (and, by extension, the client application).
7. The OAuth Identity Provider sends an authorization code to the Mobile and Social server.
8. The Mobile and Social server sends an Access Token request to the OAuth Identity Provider.  
Included in the request is the authorization code received in the previous step and the OAuth Client ID and client credential.
9. The OAuth Identity Provider returns an Access Token to the Mobile and Social server.
10. The Mobile and Social server caches the Access Token (with the User ID and the OAuth Client ID) and forwards the Access Token to the client application.
11. The client application uses the Access Token to access the protected resource and returns the protected page to the user's browser.

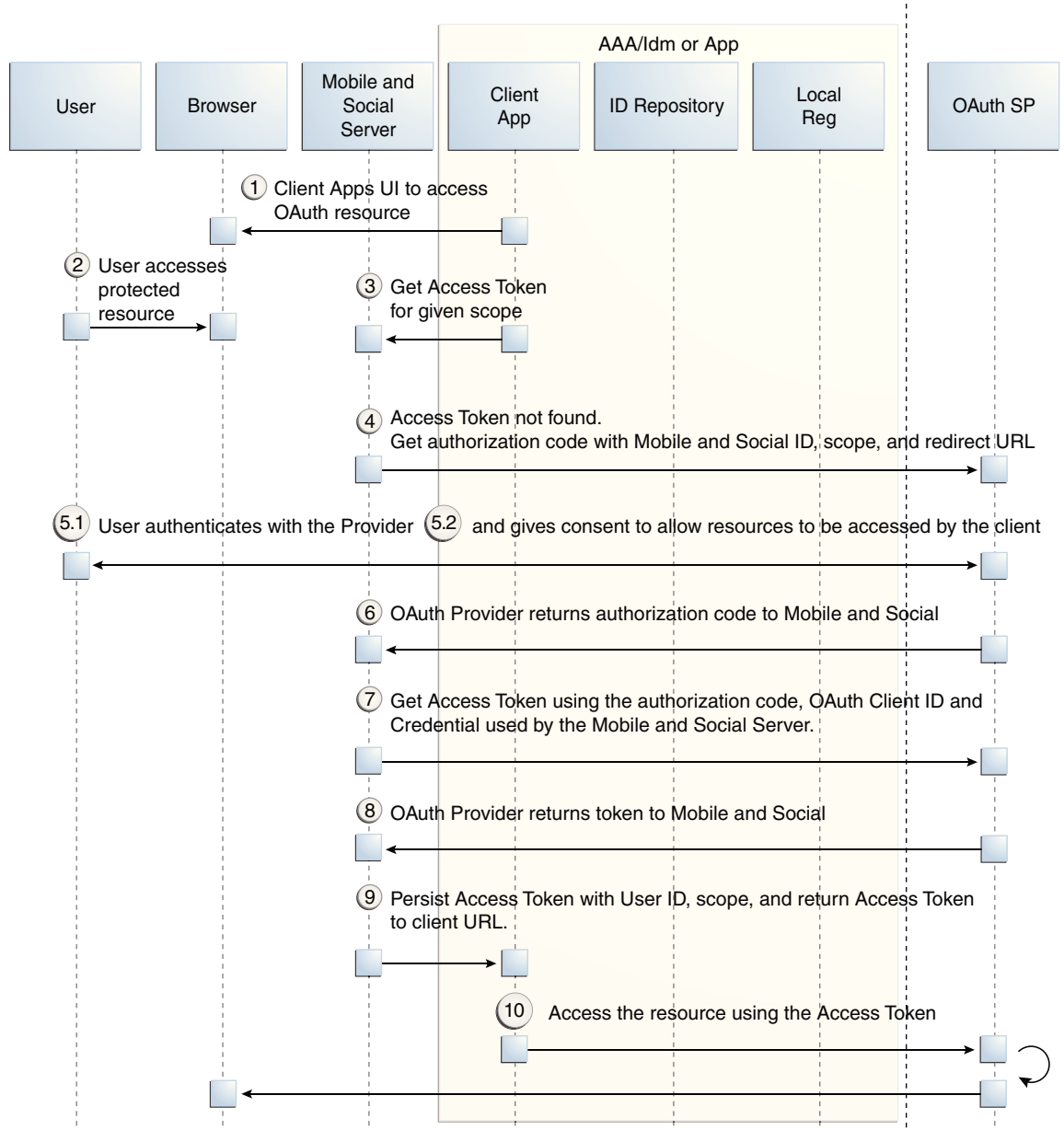
**Figure 48-10 Authenticating a User With an OAuth Identity Provider**

### 48.6.5 Authentication Flow for a User With Access Manager and Social Identity

The user must either have a local account or must register for a local account when prompted; otherwise Access Manager will not let the user access the protected resource and the User will be redirected to the login page.

This scenario describes the authentication process between the User, Access Manager, the Mobile and Social server (the relying party), and the Identity Provider.

[Figure 48-11](#), following the text, illustrates the process.

1. The user attempts to open a protected resource on the client application.
2. The WebGate protecting the resource intercepts the access request.

3. Access Manager identifies the authentication policy protecting the resource and redirects the user to a login page provided by the Mobile and Social server.
4. The login page presents a menu of Social Identity Providers.
5. The user chooses an OpenID Identity Provider and Access Manager redirects the user's browser to the Mobile and Social server, which redirects the user's browser to the login page for the selected Social Identity Provider (Google, Facebook, Twitter, and so on).
6. The user types a user name and password into the Social Identity Provider's login page.  
The Identity Provider completes the authentication process and requests the User's consent to share Identity information (if applicable).
7. When authentication is complete, the Social Identity Provider redirects the browser back to the Mobile and Social server.  
After further processing of Identity assertions supplied by the Identity Provider and after retrieving user identity information, the Mobile and Social server redirects the user's browser to Access Manager. This time HTTP headers in the page request provide Access Manager with the user's authentication status and attributes.
8. Access Manager creates a user session and redirects the user to the protected resource.

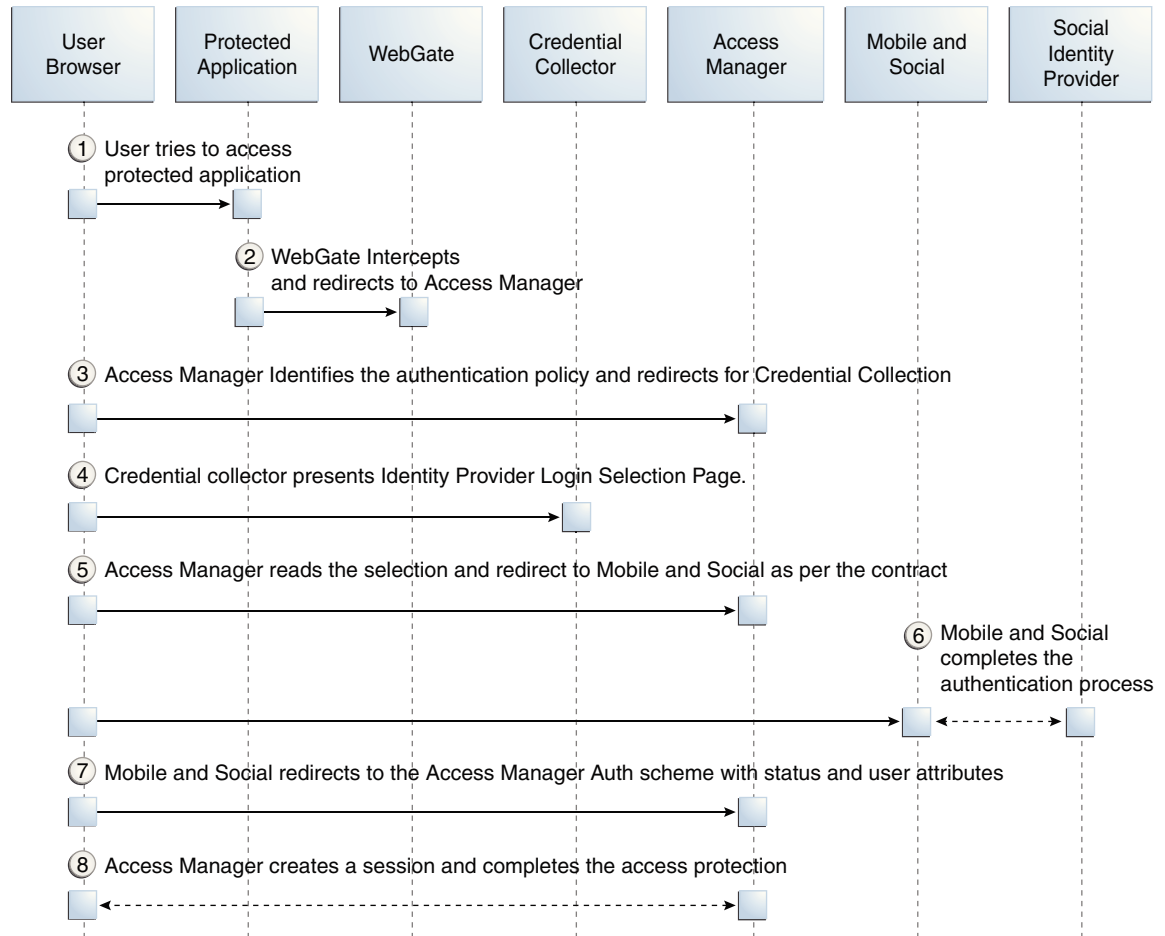
**Figure 48-11 Authenticating a User with Access Manager**

### 48.6.6 Authentication Flow for a Local User

When the user chooses not to authenticate through a Social Identity Provider, the authentication can be done using a local account.

Figure 48-12, following the text, illustrates the process.

1. The user opens a URL for a protected resource in a web browser and the Mobile and Social server presents the user with a login page and a menu of Identity Providers from which to choose.
2. The user chooses to use local authentication and types a user name and password at the login page.
3. The client application's Access Management Service carries out additional authentication steps as needed.
  - If using the JWT Token Service, a User Token may be created.
  - The OAM Token Service does not return tokens during the local authentication flow.
4. The Access Management Service creates a session for the user and the user accesses the protected resource.

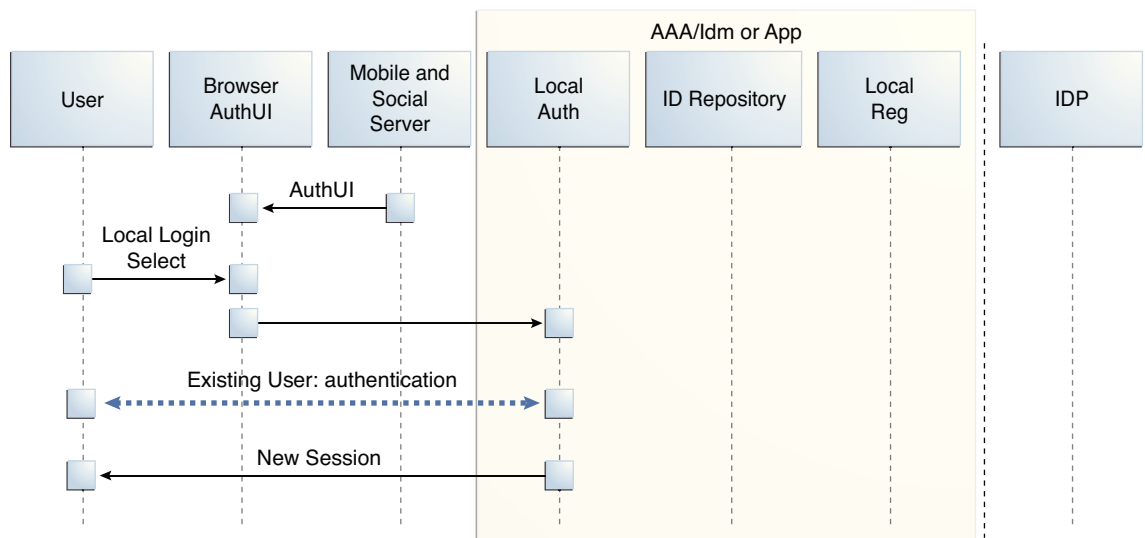
**Figure 48-12 Authenticating a User Locally**

## 48.7 Using Social Identity

There are various options for how you might use the Social Identity:

- [How Social Identity Works with Oracle Access Manager](#)
- [How Social Identity Works with Mobile and Social Services](#)
- [About the Social Identity SDK](#)

---

### See Also:

For examples of ways to integrate Social Identity, see [Understanding Social Identity Processes](#).

---

### 48.7.1 How Social Identity Works with Oracle Access Manager

Users can choose to log in to Access Manager protected resources using credentials from a Social Identity Provider if you integrate Social Identity with Access Manager.

In this arrangement, users enter their Identity Provider credentials. Access Manager forwards the User's login request to Mobile and Social, which completes the authentication process with the Identity Provider in the background. Mobile and Social (the relying party) redirects the User to Access Manager. At the same time, Mobile and Social provides Access Manager with the User's authentication status and User attributes, which were sent by the Identity Provider. For more information about how Access Manager uses Social Identity for authentication, see [Authentication Flow for a User With Access Manager and Social Identity](#).

### 48.7.2 How Social Identity Works with Mobile and Social Services

You can configure Mobile and Social Services to allow mobile devices to authenticate using Social Identity.

After an Identity Provider verifies a user's credentials, Social Identity can prompt the user to create an account with your organization. To pre-populate the new user

registration form with data returned from the Identity Provider, refer to the "Developing Applications Using the Social Identity Client SDK" chapter in the *Oracle Fusion Middleware Developer's Guide for Oracle Access Management*.

### **48.7.3 About the Social Identity SDK**

Developers who maintain Java-compliant Web applications can add Social Identity functionality to their Web offering using the Mobile and Social Social Identity SDK.

This SDK is available for Java-powered Web applications only. For information about the SDK, see the "Developing Applications Using the Social Identity Client SDK" chapter in the *Oracle Fusion Middleware Developer's Guide for Oracle Access Management*.





---

## Configuring Mobile and Social Services

Mobile and Social provides a graphical user interface for configuring Mobile and Social Services. (Prior to version 11.1.2.3, Mobile and Social Services was named Mobile Services.)

This chapter describes how to use the Oracle Access Management Console to configure Mobile and Social Services and contains the following topics.

- [Opening the Mobile and Social Services Configuration Page](#)
- [About Mobile and Social Services Configuration](#)
- [Defining Service Providers](#)
- [Defining Service Profiles](#)
- [Defining Security Handler Plug-ins](#)
- [Defining Application Profiles](#)
- [Defining Service Domains](#)
- [Using the Jailbreak Detection Policy](#)
- [Configuring Mobile and Social Services with Other Oracle Products](#)

---

**Note:**

Mobile and Social Services can be configured from the command line using WLST. For more information about the Mobile and Social WLST commands, see the *Oracle Fusion Middleware WebLogic Scripting Tool Command Reference*.

---

---

**WARNING:**

Only use tools provided with OAM Mobile and Social to change passwords, security credentials, or keys. Specifically, do not use Oracle Enterprise Manager (EM) for this purpose, because it is not compatible with the Mobile and Social credential store.

---

### 49.1 Opening the Mobile and Social Services Configuration Page

You can open the **Configuration** page of the Mobile and Social Services through **Mobile Security**.

To open the Mobile and Social Services configuration page in the Oracle Access Management Console:

1. In the Oracle Access Management Console, click **Mobile Security** at the top of the window.
2. Click **Mobile and Social Services**.

## 49.2 About Mobile and Social Services Configuration

The *Welcome to Mobile and Social - Mobile and Social Services* configuration page is divided into separate panels that can be expanded and collapsed by clicking the arrow button in the top left corner of the panel.

The following sections contain more information about the Mobile and Social Services panels.

- [Service Providers](#)
- [Service Profiles](#)
- [Security Handler Plug-ins](#)
- [Application Profiles](#)
- [Service Domains](#)

---

---

**Note:**

Mobile and Social includes pre-configured objects to support typical deployment scenarios. These objects are designed to help you get Mobile and Social up and running with only minor modifications required. Each section lists the pre-configured objects available after installation.

---

---

### 49.2.1 Service Providers

A Service Provider is defined for each back-end service that you are making available to client applications.

By configuring the back-end service as a Service Provider, the Mobile and Social server knows how to communicate with it. You can configure a back-end service as one of the following Service Provider types.

- **Authentication Service Provider** - Interfaces with an Identity Provider so that the back-end service can authenticate users, mobile devices, client applications, access permissions, and issue authentication tokens accordingly. Mobile and Social supports Access Manager and JSON Web Tokens (JWT) with their own Service Provider and Service Profile configuration objects. Further, mobile client authentication and non-mobile client authentication is managed separately so each token type has a separate mobile and non-mobile Service Provider and Service Profile. The following pre-configured Authentication Service Providers are available for typical deployments.
  - OAMAuthentication - Oracle Access Manager Authentication Token Service Provider
  - MobileOAMAuthentication - Mobile Oracle Access Manager Authentication Token Service Provider
  - JWTAuthentication - JSON Web Token Authentication Service Provider

- MobileJWTAuthentication - Mobile JSON Web Token Authentication Service Provider
- JWTOAMAuthentication - Allows lightweight, long-duration JWT tokens to be exchanged for OAM tokens. OAM tokens provide SSO and OAM resource access to clients. This provider allows users using non-mobile applications to get a new OAM token without having to provide credentials if they have a valid, long-duration JWT token.
- MobileJWTOAMAuthentication - Allows lightweight, long-duration JWT tokens to be exchanged for OAM tokens. OAM tokens provide SSO and OAM resource access to clients. This provider allows users using mobile applications to get a new OAM token without having to provide credentials if they have a valid, long-duration JWT token.
- InternetIdentityAuthentication -The Social Identity JSON Web Token Authentication Service Provider provides pre-configured support for apps using Mobile and Social Services to accept an authentication result from the Mobile and Social Social Identity.  
See [Understanding Social Identity](#).

See [Defining, Modifying or Deleting an Authentication Service Provider](#) for instructions on how to create a custom Authentication Service Provider.

- **Authorization Service Provider** - Interfaces with a back-end Identity Provider that makes authorization (access) decisions. The pre-configured OAMAuthorization Authorization Service Provider is provided for typical deployments.

See [Defining, Modifying or Deleting an Authorization Service Provider](#) for instructions on how to create a custom Authorization Service Provider.

- **User Profile Service Provider** - Interfaces with a directory server to lookup and update User Profile records. The pre-configured User Profile Service Provider is provided for typical deployments.

See [Defining, Modifying or Deleting a User Profile Service Provider](#) for instructions on how to create a custom User Profile Service Provider.

## 49.2.2 Service Profiles

After defining a Service Provider, you configure one or more *Service Profiles* for it. A Service Profile is a logical envelope that defines a Service Endpoint URL for a Service Provider on the Mobile and Social server.

You can create multiple Service Profiles for a Service Provider to define different token capabilities and service endpoints. Each Service Provider instance requires at least one corresponding Service Profile. Mobile and Social includes a pre-configured Service Profile for each pre-configured Service Provider configuration object.

See [Service Providers](#)

## 49.2.3 Security Handler Plug-ins

A *Security Handler Plug-in* enhances security by consulting additional logic for trust and risk analysis. Such additional logic may deny certain risky operations.

The Security Handler Plug-in applies the logic during Authentication Service operations, including client application registration. Using a Security Handler Plug-in

is optional. The Security Handler Plug-ins provided with this version of the software are optimized for mobile applications. If used, only apply it to mobile-related Service Domains, its authentication services, and client applications. Do not use a Security Handler Plug-in with a non-mobile application.

Mobile and Social invokes the Security Handler Plug-in during sensitive security operations (such as authentication) as well as during operations that involve token acquisition. Mobile and Social includes the following preconfigured Security Handler Plug-ins:

- The `OAAMSecurityHandlerPlugin` enables the sophisticated device registration and risk-based strong authentication logic available in Oracle Adaptive Access Manager.
- The `Default Security Handler Plug-in` offers more limited device registration logic.

#### 49.2.4 Application Profiles

An *Application Profile* describes the configuration and security properties of the client application that will consume services provided by the Service Provider. An Application Profile is required either when mobile applications are used, or when a non-mobile application is used with a service that does not have secured application protection.

Attributes defined include an Application Profile name, a short description of the application, a list of name-value attribute pairs, and its mobile configuration settings. (Mobile configuration settings include options such as the maximum duration in minutes that the Profile can be cached, the number of allowable authentication retries, and whether offline authentication is allowed.) You can also choose which mobile device attributes (such as `phonecarriername`, `phonenumbers`, `osversion`, and so on) are required for the application. A single Application Profile can be assigned to multiple Service Domains.

#### 49.2.5 Service Domains

A *Service Domain* is a logical grouping that serves to associate a Service Profile with an Application Profile and (optionally) a Security Handler Plug-in. A Service Domain specifies how applications are allowed to access services in Mobile and Social.

Typically an organization should have one Service Domain for managing mobile apps, and a separate Service Domain for managing non-mobile apps. When creating a Service Domain you:

- Decide whether the Service Domain is for managing mobile applications or desktop applications.
- Choose an authentication scheme and, optionally, a Security Handler Plug-in for the Service Domain.
- Add one or more Mobile SSO Agents and configure which agents have priority over the others.
- Add one or more applications to the Service Domain and configure which can use a Mobile SSO Agent.
- Choose at least one Service Profile for the Service Domain.
- Configure security settings to protect the Service Domain services.

Mobile and Social includes the following pre-configured Service Domains:

- The Default (Service Domain) is pre-configured for non-mobile applications.
- The Mobile Service Domain is pre-configured for mobile applications.

Use one of these Service Domains as a template to create your own, or modify them to suit the needs of your organization. Only mobile authentication Service Profiles can be added to a mobile Service Domain.

## 49.3 Defining Service Providers

A Service Provider is defined for each back-end service that is available to client applications.

This configures how the Mobile and Social server will interface with the defined back-end Service Provider. Depending on the services that you are providing, you may only need to configure one or two of the available Service Provider options. For example, if you are only providing authentication services, you do not need to define the User Profile Service Provider or Authorization Service Provider.

You need to familiarize yourself with the following topics to define Service Providers:

- [Defining, Modifying or Deleting an Authentication Service Provider](#)
- [Defining, Modifying or Deleting an Authorization Service Provider](#)
- [Defining, Modifying or Deleting a User Profile Service Provider](#)

### 49.3.1 Defining, Modifying or Deleting an Authentication Service Provider

An *Authentication Service Provider* allows Mobile and Social to authenticate users, client applications, and access permissions using a back-end Authentication Service by way of a token exchange.

Upon successful authentication and verification, a token may be returned to the client application. The following authentication types are supported.

- When installed with Access Manager, Mobile and Social supports JSON Web Tokens (JWT) and Access Manager (OAM) tokens.
- When installed without Access Manager, only the JSON Web Token (JWT) type is supported.

---

---

**Note:**

See [Deployment Constraints for Mobile and Social](#) for information about deploying Mobile and Social with a Webgate.

---

---

The following topics include information regarding Authentication Service Providers:

- [Pre-Configured Authentication Service Providers](#)
- [JWT-OAM Token Authentication Service Provider](#)
- [Creating an Authentication Service Provider](#)
- [Editing or Deleting an Authentication Service Provider](#)

- [Using User Credentials to Exchange a JWT Token for an OAM Token](#)
- [Configuring OAM to use the JWT-OAM and PIN Token Service Provider](#)

### 49.3.1.1 Pre-Configured Authentication Service Providers

Mobile and Social provides pre-configured Authentication Service Providers for the Authentication Services listed.

See [Table 49-1](#) for details.

For each token type (Access Manager and JWT), Mobile and Social provides separate "out-of-the-box" mobile and non-mobile (or *desktop*) Service Provider configurations. Separate configurations are provided so that you can optimize each to best meet the needs of each access mode. Mobile devices must use a mobile Service Provider, however, non-mobile devices can use either a mobile service provider or a non-mobile service provider if correct input is provided.

Mobile Service Providers use Client Registration Handles to register mobile devices, whereas non-mobile Service Providers use Client Tokens to authenticate non-mobile devices. The Client Token capability in Mobile and Social can be disabled, but the Client Registration Handle capability cannot.

**Table 49-1 Pre-configured Authentication Service Providers**

Authentication Service	Mobile and Social Service Provider Name	Description
Access Manager	OAMAuthentication	<p>Provides pre-configured support for users using desktop devices to authenticate using Access Manager.</p> <p>This Service Provider can issue a Client Token, but it cannot register mobile devices.</p> <p>The following Java class implements this Service Provider:</p> <pre>oracle.security.idaas.rest.provider.token.OAMSDKTokenServiceProvider</pre>
Mobile Access Manager	MobileOAMAuthentication	<p>Provides pre-configured support for users using mobile devices to authenticate using Access Manager.</p> <p>This Service Provider supports registering new devices using a Client Registration Handle when the User authenticates.</p> <p>The following Java class implements this Service Provider:</p> <pre>oracle.security.idaas.rest.provider.token.MobileOAMTokenServiceProvider</pre>

**Table 49-1 (Cont.) Pre-configured Authentication Service Providers**

<b>Authentication Service</b>	<b>Mobile and Social Service Provider Name</b>	<b>Description</b>
JSON Web Token	JWTAuthentication	<p>Provides pre-configured support for users using non-mobile applications to authenticate using the JSON Web Token format. JSON Web Token is a compact token format that is suitable for space-constrained environments such as HTTP Authorization headers.</p> <p>This Service Provider can issue a Client Token, but it cannot register new devices using a Client Registration Handle.</p> <p>The following Java class implements this Service Provider:</p> <pre>oracle.security.idaas.rest.provider.token.JWTTokenServiceProvider</pre>
Mobile JSON Web Token	MobileJWTAuthentication	<p>Provides pre-configured support for users using mobile devices to authenticate using the Mobile JSON Web Token format.</p> <p>This Service Provider supports registering new devices using a Client Registration Handle.</p> <p>The following Java class implements this Service Provider:</p> <pre>oracle.security.idaas.rest.provider.token.MobileJWTTokenServiceProvider</pre>
JWT-OAM Token Provider	JWTOAMAuthentication	<p>Allows lightweight, long-duration JWT tokens to be exchanged for OAM tokens. OAM tokens provide SSO and OAM resource access to clients. This provider allows users using non-mobile applications to get a new OAM token without having to provide credentials if they have a valid, long-duration JWT token.</p>
Mobile JWT-OAM Token Provider	MobileJWTOAMAuthentication	<p>Allows lightweight, long-duration JWT tokens to be exchanged for OAM tokens. OAM tokens provide SSO and OAM resource access to clients. This provider allows users using mobile applications to get a new OAM token without having to provide credentials if they have a valid, long-duration JWT token.</p>

**Table 49-1 (Cont.) Pre-configured Authentication Service Providers**

Authentication Service	Mobile and Social Service Provider Name	Description
Social Identity Web Token	InternetIdentityAuthentication	<p>Provides pre-configured support for apps using Mobile and Social Services to accept an authentication result from Social Identity (for example, Google, Facebook, Twitter, and so on).</p> <p>This Service Provider supports registering new devices using a Client Registration Handle. After the User authenticates with the Identity Provider, this Service Provider issues a User Token to the requesting client application. The User Token allows the User to obtain a Client Registration Handle for the device.</p> <p>This service uses the same Java class as the JSON Web Token service, but it is configured with two additional name-value attribute pairs.</p> <p>The following Java class implements this Service Provider:</p> <pre>oracle.security.idaas.rest.provider.token.JWTTokenServiceProvider</pre>

### 49.3.1.2 JWT-OAM Token Authentication Service Provider

The `JWTOAMAuthentication` and the `MobileJWTOAMAuthentication Service Provider` types require further explanation. The JWT-OAM token provider lets mobile and non-mobile clients use a JSON Web Token (JWT) to retrieve an OAM User token and an OAM Master token.

Depending on your deployment, you may want to have a long-duration JWT token instead of one or more long-duration OAM tokens. A JWT token is lightweight and makes an ideal token to hold for a long duration.

Using the JWT-OAM token exchange feature, your application authenticates the user with a user name and password, then obtains a JWT token, an OAM user token, and an OAM master token. You can configure the JWT token to have a very long duration compared to the duration of OAM tokens. Once the OAM tokens expire, clients use the still-valid long-duration JWT token to get OAM tokens again.

The presence of OAM tokens can provide mobile and non-mobile clients with access to resources protected by Access Manager. Exchanging a JWT token for OAM tokens benefits the user, who does not need to provide credentials to get new OAM tokens to replace the expired tokens.

As an added security measure, Mobile and Social can require users to enter an additional credential, such as a PIN, when using a JWT user token to get an OAM token.

See [Using User Credentials to Exchange a JWT Token for an OAM Token](#).

### 49.3.1.3 Creating an Authentication Service Provider

You can create an authentication service provider and modify its default attributes and values.

To create an Authentication Service Provider:



1. Access the Mobile and Social Services configuration page.

See [Opening the Mobile and Social Services Configuration Page](#).

2. Click **Create** in the **Service Providers** section and choose **Create Authentication Service Provider**.

The Authentication Service Provider Configuration page displays.

3. Enter values for the Authentication Service Provider properties.
  - **Name** - Type a unique name for this Authentication Service Provider.
  - **Description** - (Optional) Type a short description that will help you or another Administrator identify this service in the future.
  - **Service Provider Java Class** - Type the name of the Java class that implements this Authentication Service Provider.
4. Add or delete Authentication Service Provider Attributes and their values based on either [Table 49-2](#) (OAMAuthentication and the MobileOAMAuthentication Service Provider types), [Table 49-4](#) (JWTAuthentication and the MobileJWTAuthentication Service Provider types), or [Table 49-5](#) (JWT-OAM Authentication Service Provider Default Attributes).

---



---

**Note:**

If you created a custom Authentication Service Provider, use the Attributes panel to further configure it. For the JWTAuthentication and MobileJWTAuthentication Service Providers, custom attributes are not used.

---



---

- [Table 49-2](#) and [Table 49-3](#) are specific to a Mobile and Social integration with Access Manager. The values in [Table 49-2](#) apply to both the OAMAuthentication and the MobileOAMAuthentication Service Provider types. The values in [Table 49-3](#) configure the Webgate agent.

**Table 49-2 Access Manager Authentication Service Provider Default Attributes**

Name	Default Value	Notes
OAM_VERSION	OAM_11G	Either <b>OAM_11G</b> or <b>OAM_10G</b> , depending on the Oracle Access Manager version in use.
DEBUG_VALUE	0	

**Table 49-2 (Cont.) Access Manager Authentication Service Provider Default Attributes**

Name	Default Value	Notes
TRANSPORT_SECURITY	OPEN	Specify the method for encrypting messages between this AccessGate and the Access Servers. The encryption methods need to match. Valid values include: <ul style="list-style-type: none"> <li>– OPEN</li> <li>– SIMPLE</li> <li>– CERT</li> </ul> To update these settings, see <a href="#">Configuring Mobile and Social Services to Work With Access Manager in Simple and Certificate Mode</a> .
OAM_SERVER_1	localhost: 5575	Specify the host name and port number of the primary Oracle Access Management server.
OAM_SERVER_1_MAX_CONNECTIONS	4	Specify the maximum number of connections that this Mobile and Social instance can establish with OAM_SERVER_1. The default value is 4.
OAM_SERVER_2	oam_server_2: 5575	Specify the host name and port number of the secondary Oracle Access Management server.
OAM_SERVER_2_MAX_CONNECTIONS	4	Specify the maximum number of connections that this Mobile and Social instance can establish with OAM_SERVER_2. The default value is 4.
IDContextEnabled	true	Add this attribute with a value of true to enable Identity Context, as described in <a href="#">Configuring Oracle Access Management Mobile and Social</a> .

**Table 49-2 (Cont.) Access Manager Authentication Service Provider Default Attributes**

Name	Default Value	Notes
OAM_LOCAL_MODE	true	<p>Specifies if Mobile and Social should use "local mode" or "remote mode" to communicate with the OAM server. If the attribute value is set to <b>false</b>, Mobile and Social communicates with OAM over TCP/IP. If set to <b>true</b> (or if this attribute is undefined), Mobile and Social uses a direct connection to communicate with OAM.</p> <p>Prior to version 11.1.2.3, Mobile and Social only communicated with OAM using TCP/IP (that is, remote mode). Now communication defaults to local, which is faster.</p> <p>To configure Mobile and Social to communicate with OAM 10g, set the OAM_LOCAL_MODE attribute to <b>false</b>.</p>

**Table 49-3 Webgate Agent for Authentication Service Provider Default Attributes**

Name	Default Value	Notes
Webgate ID		Type the Webgate agent name that identifies the Webgate instance to which you are connecting.
Encrypted Password	Copy and paste the encrypted password for the Webgate ID	Locate the <i>OAM-Domain-Directory/output/Profile-Name/ObAccessClient.xml</i> file and copy the encrypted password value located in the element <code>ParamName=accessClientPassword</code> .

- [Table 49-4](#) is specific to connecting a Mobile and Social server to JWT Authentication Service Providers. The configuration values in this section apply to both the JWTAuthentication and the MobileJWTAuthentication Service Provider types.

**Table 49-4 JWT Authentication Service Provider Default Attributes**

Name	Default Value	Notes
Identity Directory Service Name	Select from the menu the Directory Service that should be used to verify the User.	The JWT token service verifies the user with a directory server.

**Table 49-4 (Cont.) JWT Authentication Service Provider Default Attributes**

Name	Default Value	Notes
Crypto Scheme	RS512	The cryptographic algorithm used to sign the contents of the JWT token. The default value is RS512. (RSA encryption using SHA-512 hash algorithm.)
Validity Period	3600	The length of time in seconds that the token is considered to be valid. The default value is 3600.
Relying Party Token	Enabled	Select Enabled if the Service Provider should accept security tokens from an external issuer.
Issuer		If <i>Relying Party Token</i> is enabled, specify the Security Token Service issuer

[Table 49-5](#) is specific to the JWTOAMAuthentication and the MobileJWTOAMAuthentication Service Provider types.

**Table 49-5 JWT-OAM Authentication Service Provider Default Attributes**

Name	Default Value	Notes
OAM_VERSION	OAM_11G	Either <b>OAM_11G</b> or <b>OAM_10G</b> , depending on the Oracle Access Manager version in use.
DEBUG_VALUE	0	
TRANSPORT_SECURITY	OPEN	Specify the method for encrypting messages between this AccessGate and the Access Servers. The encryption methods need to match. Valid values include: <ul style="list-style-type: none"> <li>- <b>OPEN</b></li> <li>- <b>SIMPLE</b></li> <li>- <b>CERT</b></li> </ul>
OAM_SERVER_1	localhost:5575	Specify the host name and port number of the primary Oracle Access Management server.
OAM_SERVER_1_MAX_CONNECTIONS	4	Specify the maximum number of connections that this Mobile and Social instance can establish with OAM_SERVER_1. The default value is 4.
OAM_SERVER_2	oam_server_2:5575	Specify the host name and port number of the secondary Oracle Access Management server.

**Table 49-5 (Cont.) JWT-OAM Authentication Service Provider Default Attributes**

Name	Default Value	Notes
OAM_SERVER_2_MAX_CONNECTIONS	4	Specify the maximum number of connections that this Mobile and Social instance can establish with OAM_SERVER_2. The default value is 4.
user.Authenticator	<ul style="list-style-type: none"> <li>- Default value for JWTOAMAuthenticator provider: oracle.security.idaas.rest.provider.token.OAMSDKTokenServiceProvider</li> <li>- Default value for MobileJWT OAMAuthentication provider: oracle.security.idaas.rest.provider.token.JWTTokenServiceProvider</li> </ul>	<p>Optional. Specify which of two available authenticators to use for user authentication.</p> <ul style="list-style-type: none"> <li>- For OAM Authentication: oracle.security.idaas.rest.provider.token.OAMSDKTokenServiceProvider</li> <li>- For IDS Authentication: oracle.security.idaas.rest.provider.token.JWTTokenServiceProvider</li> </ul>
UserAuthenticationInput	UIDPASSWORD	Specify how the client application should authenticate the user. The only supported value is UIDPASSWORD.

**Table 49-5 (Cont.) JWT-OAM Authentication Service Provider Default Attributes**

Name	Default Value	Notes
UserAuthenticationOutput	USERTOKEN	<p>Specify all possible token types that the client application will receive if user authentication is successful.</p> <p>Configure this parameter with any combination of the following:</p> <ul style="list-style-type: none"> <li>– USERTOKEN: :JWTUT</li> <li>– USERTOKEN: :OAMUT</li> <li>– USERTOKEN::OAMMT</li> </ul> <p>JWTUT specifies the JWT-type user token.</p> <p>OAMUT specifies the OAM-type user token.</p> <p>OAMMT specifies the OAM-type master token.</p> <p>If no value is supplied, all three token types are assumed.</p>
TokenExchangeInput	JWT_UT+CRED	<p>Specifies what is required to exchange a JWT type user token for an OAM token.</p> <p>Configure this parameter with one of the following:</p> <ul style="list-style-type: none"> <li>– JWT_UT</li> <li>– JWT_UT+CRED</li> </ul> <p>JWT_UT specifies that a JWT type user token is required to get OAM tokens.</p> <p>JWT_UT+CRED specifies that, in addition to a JWT user token, an additional credential such as a personal identification number is required to get OAM tokens.</p> <p>If no value is supplied, the token exchange feature is disabled.</p>
TokenExchangeOutput	USERTOKEN: :OAMUT, USERTOKEN: :OAMMT	<p>Configure this parameter with any combination of the following:</p> <ul style="list-style-type: none"> <li>– USERTOKEN: :OAMUT</li> <li>– USERTOKEN: :OAMMT</li> </ul> <p>OAMUT specifies the OAM type user token.</p> <p>OAMMT specifies the OAM type master token.</p>

**Table 49-5 (Cont.) JWT-OAM Authentication Service Provider Default Attributes**

Name	Default Value	Notes
OAM_LOCAL_MODE	true	<p>Specifies if Mobile and Social should use "local mode" or "remote mode" to communicate with the OAM server. If the attribute value is set to <b>false</b>, Mobile and Social communicates with OAM over TCP/IP. If set to <b>true</b> (or if this attribute is undefined), Mobile and Social uses a direct connection to communicate with OAM.</p> <p>Prior to version 11.1.2.3, Mobile and Social only communicated with OAM using TCP/IP (that is, remote mode). Now communication defaults to local, which is faster.</p> <p>To configure Mobile and Social to communicate with OAM 10g, set the OAM_LOCAL_MODE attribute to <b>false</b>.</p>

5. Click Create to create the Service Provider configuration object.

#### 49.3.1.4 Editing or Deleting an Authentication Service Provider

You can edit or delete an Authentication Service Provider.

Select the Service Provider in the panel and click Edit or Delete on the panel's tool bar.

#### 49.3.1.5 Using User Credentials to Exchange a JWT Token for an OAM Token

As an added security measure, Mobile and Social can require users to enter an additional credential, such as a PIN, when using a JWT user token to get an OAM token.

To enable the user PIN requirement, specify the `JWT_UT+CRED` parameter as described in [Table 49-5](#) when configuring the `TokenExchangeInput` attribute.

To use this feature, the user PIN or other credential must be present in the user entry in the directory server. Mobile and Social does not put restrictions on credential values; it simply validates the credential value submitted by the user with the value present in the user entry. For security reasons, user credentials should be saved as hashed attributes.

See [Configuring OAM to use the JWT-OAM and PIN Token Service Provider](#) for the steps required to get this configuration to work.

#### 49.3.1.6 Configuring OAM to use the JWT-OAM and PIN Token Service Provider

You can configure OAM to use the JWT-OAM and the PIN Token Service Provider.

To configure:

1. Open your directory server and extend the LDAP Schema for the PIN Attribute. After the LDAP schema change, you can add new users and modify existing users to have a PIN value.
  - a. Create the PIN attribute.

Figure 49-1 provides an example on how to use Oracle Directory Services Manager (ODSM) and Oracle Unified Directory (OUD).

**Figure 49-1 Using ODSM to create the PIN attribute in OUD**

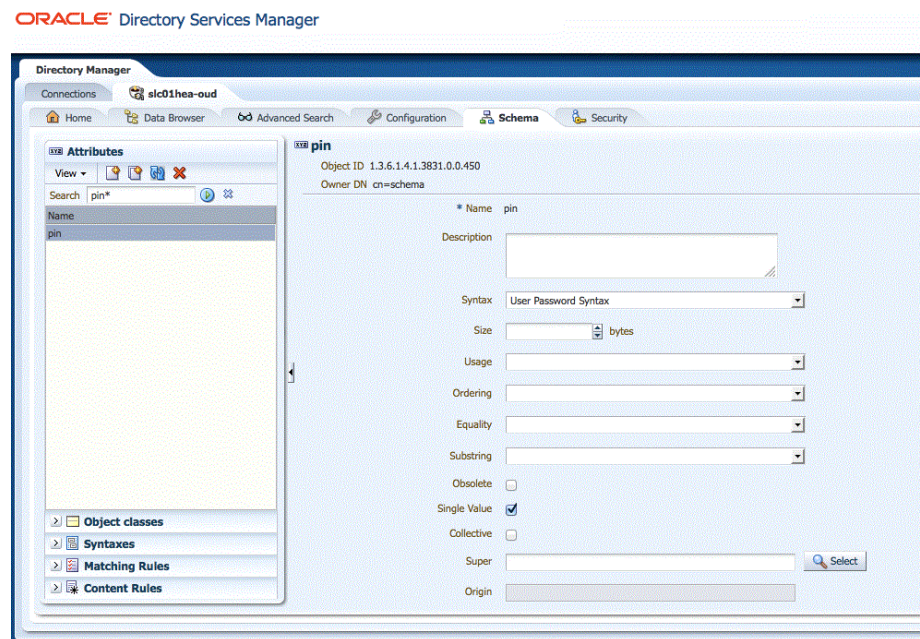

- b. Create a PINPERSON object class.

Figure 49-2 provides an example using Oracle Directory Services Manager (ODSM).

**Figure 49-2 Using ODSM to create the pinperson object class**

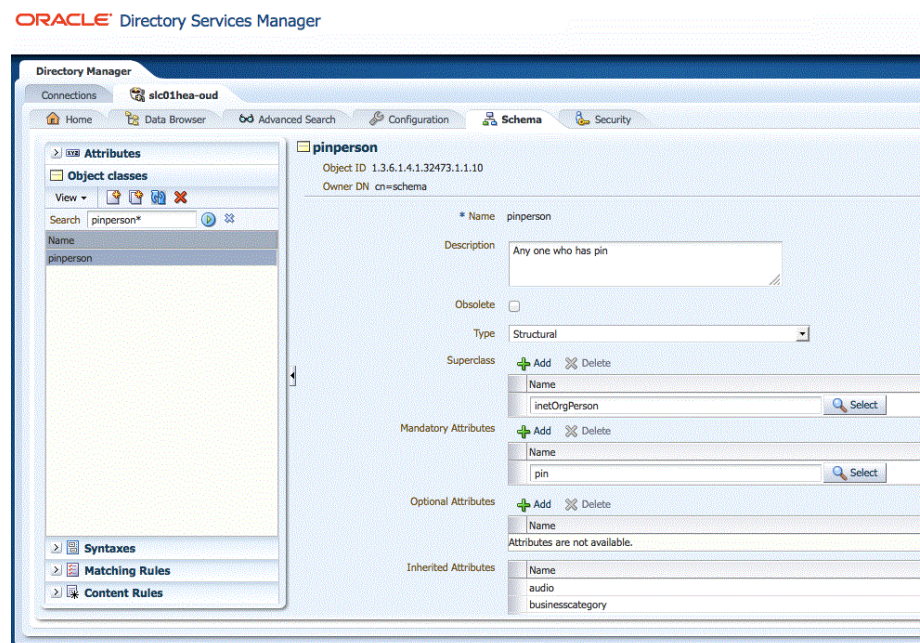

2. Using the OAM Console, create a new IdentityStore for the external LDAP server that you extended to use the PIN attribute.



- a. Log in to the OAM Console and click **Configuration** at the top of the window.
- b. Click **User Identity Stores**.
- c. Click the **Create** button to create a new IdentityStore in OAM ID Stores.  
See [Figure 49-3](#) for details.

**Figure 49-3 Using the OAM Console to create an IdentityStore**

The screenshot shows the configuration page for a new Identity Store named 'msmad'. The page is divided into several sections:

- General Information:** Store Name: msmad, Store Type: AD: Microsoft Active Directory, Description: (empty).
- Location and Credentials:** Location: domain2.bitzerqa1.com:389, Bind DN: CN=Administrator,CN=.
- Users and Groups:**
  - Login ID Attribute: userprincipalname
  - User Password Attribute: userPassword
  - User Search Base: OU=Users,OU=msm,DC=domain2,DC=
  - User Filter Object Classes: user
  - Group Name Attribute: cn
  - Group Search Base: OU=Roles,OU=msm,DC=domain2,DC=
  - Group Filter Classes: group
- Cache Settings:**
  - Enable Group Membership Cache: (checked)
  - Group Membership Cache Maximum Size: 10000
  - Group Membership Cache Time to Live (in seconds): 0
- Connection Details:**
  - Minimum Pool Size: 10
  - Maximum Pool Size: 50
  - Wait Timeout (in seconds): 120
  - Inactivity Timeout (in seconds): 0
  - Results time limit (in seconds): 0
  - Retry Count: 3
  - Referral Policy: follow
- Password Management:**
  - Enable Password Management: (checked)

Buttons at the top right include 'System Store', 'Duplicate', 'Test Connection', and 'Apply'.

3. Add a new OAM authentication module for the new Identity Store.
  - a. In the OAM console, click **Application Security** at the top of the window.
  - b. Select **Create Custom Authentication Module** from the **Create (+)** drop-down menu in the **Plug-ins** section.
  - c. On the **General** tab, type a **Name**--for example, `PINBasedUserPlugIn`.
  - d. On the **Steps** tab, type the following values:
    - Step Name:** UI
    - Plug-in Name:** UserIdentificationPlugIn
    - Plug-in Parameters:**
      - **KEY\_LDAP\_FILTER:** `(&(uid={KEY_USERNAME})(pin={cred}))`

- **KEY\_IDENTITY\_STORE\_REF:** OUDIdentityStore (This data store has to be added first to do this step.)
  - **KEY\_SEARCH\_BASE\_URL:** ou=users,dc=ngam,dc=oracle,dc=com
- e. On the **Steps Orchestration** tab, choose **UI** from the **Initial Step** menu.
4. Add a new authentication scheme.
    - a. In the OAM console, click **Application Security** at the top of the window.
    - b. Select **Create Authentication Scheme** from the **Create (+)** drop-down menu in the **Access Manager** section.
    - c. Complete the form:
      - Name:** PINBasedUserAuthNScheme
      - Authentication Level:** 3
      - Challenge Method:** FORM
      - Authentication Module:** Choose the authentication module you created in the previous step--for example, PINBasedUserPlugin.
  5. Change the authentication policy to use the new authentication scheme.
    - a. In the OAM console, click **Application Security** at the top of the window.
    - b. Click **Application Domains** in the **Access Manager** section.
    - c. Find the **IAM Suite** domain and open the **OICTokenExchangePolicy** policy.
    - d. From the **Authentication Scheme** drop-down menu, choose **PINBasedUserAuthNScheme**.
  6. Configure the (Mobile) JWTOAMAuthenticationProvider.
    - a. In the OAM console, click **Mobile Security** at the top of the window.
    - b. Click **Mobile and Social Services**.
    - c. Open the **MobileJWTOAMAuthentication** service provider for editing.
    - d. From the **Identity Directory Service Name** drop-down menu, choose the directory service that points to the IdentityStore you created in step 2.
    - e. If a desktop (or non-mobile) service is required, repeat steps a and b to configure the JWTOAMAuthentication provider.
  7. Create an application profile.
    - a. In the OAM console, click **Mobile Security** at the top of the window.
    - b. Click **Mobile and Social Services**.
    - c. In the **Application Profiles** section, click the **Create** button and create a new application profile (for example, mobileapp1).
  8. Update the MobileServiceDomain.
    - a. In the OAM console, click **Mobile Security** at the top of the window.

- b. Click **Mobile and Social Services**.
- c. In the Service Domains section, find the **MobileServiceDomain** domain and open it for editing.
- d. In the **Application Profiles** section (subtab), add the application profile you created in the previous step (mobileapp1).
- e. Click the **Service Profiles** subtab to open it and change the **Authentication Service** to MobileJWTOAuthAuthentication.

## 49.3.2 Defining, Modifying or Deleting an Authorization Service Provider

An *Authorization Service Provider* allows a back-end Identity service to make authorization decisions on behalf of a connected application.

The following topics provide information about Authorization Service Providers:

- [Creating an Authorization Service Provider](#)
- [Editing or Deleting an Authorization Service Provider](#)
- [Pre-Configured Authorization Service Provider](#)

### 49.3.2.1 Creating an Authorization Service Provider

You can create an authorization service provider and modify its attributes and values.

To create:

1. Access the Mobile and Social Services configuration page.

See [Opening the Mobile and Social Services Configuration Page](#)

2. Click **Create** in the **Service Providers** section and choose **Create Authorization Service Provider**.

The Authorization Service Provider Configuration page displays.

3. Enter values for the Authorization Service Provider properties.
  - **Name** - Type a unique name for this Authorization Service Provider.
  - **Description** - (Optional) Type a short description that will help you or another Administrator identify this service in the future.
  - **Service Provider Java Class** - Type the name of the Java class that implements this Authorization Service Provider.
4. Add or delete Authorization Service Provider Attributes and their values.

[Table 49-6](#) lists the attributes for the Access Manager Authorization Service Provider.

**Table 49-6 Access Manager Authorization Service Provider Default Attributes**

Name	Value	Notes
OAM_VERSION	OAM_11G	Either <b>OAM_11G</b> or <b>OAM_10G</b> , depending on the Oracle Access Manager version in use.
DEBUG_VALUE	0	
TRANSPORT_SECURITY	OPEN	Specify the method for encrypting messages between this AccessGate and the Access Servers. The encryption methods need to match. Valid values include: <ul style="list-style-type: none"> <li>• <b>OPEN</b></li> <li>• <b>SIMPLE</b></li> <li>• <b>CERT</b></li> </ul>
OAM_SERVER_1	localhost:5575	Specify the host name and port number of the primary Oracle Access Management server.
OAM_SERVER_1_MAX_CONNECTION	4	Specify the maximum number of connections that this Mobile and Social instance can establish with OAM_SERVER_1. The default value is 4.
OAM_SERVER_2	oam_server_2:5575	Specify the host name and port number of the secondary Oracle Access Management server.
OAM_SERVER_2_MAX_CONNECTION	4	Specify the maximum number of connections that this Mobile and Social instance can establish with OAM_SERVER_2. The default value is 4.

5. Configure the Webgate agent by creating a new agent or entering values for an existing agent as per [Table 49-7](#). The Webgate agent configuration values are specific to the integration between Mobile and Social Services and Access Manager.

**Table 49-7 Webgate Agent for Authorization Service Provider Default Attributes**

Name	Value	Notes
Webgate ID		Type the Webgate agent name that identifies the Webgate instance to which you are connecting.
Encrypted Password	Copy and paste the encrypted password for the Webgate ID	Locate the <i>OAM-Domain-Directory/output/Profile-Name/ObAccessClient.xml</i> file and copy the encrypted password value located in the element <code>ParamName=accessClientPasswd</code> .

6. Click Create to create the Service Provider configuration object.

### 49.3.2.2 Editing or Deleting an Authorization Service Provider

You can edit or delete an Authorization Service Provider.

Select the Service Provider in the panel and click Edit or Delete on the panel's tool bar.

### 49.3.2.3 Pre-Configured Authorization Service Provider

Mobile and Social provides a pre-configured Authorization Service Provider for Access Manager named the OAMSDKAuthZServiceProvider.

The

`oracle.security.iamas.rest.provider.authorization.OAMSDKAuthZServiceProvider` Java class implements the pre-configured Authorization Service Provider.

## 49.3.3 Defining, Modifying or Deleting a User Profile Service Provider

A *User Profile Service Provider* allows an application to query and update a directory server.

Many LDAP compliant directory servers are supported including:

- Microsoft Active Directory
- Novell eDirectory
- Oracle Directory Server Enterprise Edition
- Oracle Internet Directory
- Oracle Unified Directory
- Oracle Virtual Directory (using the Oracle Internet Directory template)
- OpenLDAP
- IBM Tivoli Directory Server (using the OpenLDAP template)
- WebLogic Server Embedded LDAP

Mobile and Social includes a pre-configured User Profile Service Provider that your organization can use, or you can create your own. Before you can create a User Profile Service Provider you must first create an *Identity Directory Service* profile. The (IDS) is a flexible service used by Access Manager as the means for accessing multiple identity data stores. For more information about the Identity Directory Service, see [Managing the Identity Directory Service User Identity Stores](#).

The following sections contain more information about User Profile Service Providers.

- [Creating a User Profile Service Provider](#)
- [Editing or Deleting a User Profile Service Provider](#)
- [Pre-Configured User Profile Service Provider](#)

### 49.3.3.1 Creating a User Profile Service Provider

You can create a User Profile Service Provider and modify its attributes and values.

To create:

1. Access the Mobile and Social Services configuration page.

See [Opening the Mobile and Social Services Configuration Page](#).

2. Click **Create** in the **Service Providers** section and choose **Create User Profile Service Provider**.

The Service Provider Configuration page displays.

3. Enter values for the User Profile Service Provider properties.

- **Name** - Type a unique name for this User Profile Service Provider.
- **Description** - (Optional) Type a short description that will help you or another Administrator identify this service in the future.

4. Add or delete User Profile Service Provider Attributes and their values.

See [Table 49-8](#) for details.

---

**Note:**

LDAP attribute names are generally not case sensitive but when communicating with the Oracle Identity Governance Framework (IGF), LDAP attribute names *are* case sensitive.

---

**Table 49-8 User Profile Service Provider Default Attribute Names and Values**

Name	Value	Notes
accessControl	false	Supported values include <b>true</b> or <b>false</b> (enable/disable, respectively) depending on whether the accessControl feature is to be disabled or enabled.
adminGroup	cn=Administrators,ou=groups,ou=myrealm,dc=base_domain	If accessControl is enabled, specify the distinguished name (DN) of the adminGroup to see if the User is in it.
selfEdit	true	Supported values include <b>true</b> or <b>false</b> depending on if the User can edit his or her profile for the accessControl feature. This is also one of the accessControl feature's configuration properties.
proxyAuth	-	Supported values include <b>true</b> or <b>false</b> depending on if the proxyAuth feature is enabled or disabled, respectively. This attribute is required only if proxyAuth is supported and the Administrator does not want to use the proxyAuth feature.  This attribute is not included in a new installation of Mobile and Social. An Administrator can add this property.

5. In the **Identity Directory Service** section, choose from the **Name** menu the Identity Directory Service profile to use with this User Profile Service Provider.
  - To create an Identity Directory Service profile.  
See [Creating an Identity Directory Service Profile](#).
  - If you choose either of the default Identity Directory Services (`userrole` or `idxuserrole`) you can't view or edit the configuration values in this section.
  - If you choose an Identity Directory Service connection that you or another administrator created, select the **View** option to view and edit additional properties.  
See [Editing or Deleting a User Profile Service Provider](#).
6. Click **Create** to create the Service Provider configuration object.

### 49.3.3.2 Editing or Deleting a User Profile Service Provider

You can edit or delete a User Profile Service Provider.

Select the Service Provider in the panel and click Edit or Delete on the panel's tool bar.

### 49.3.3.3 User Profile Service Provider Configuration Properties

When you edit a User Profile Service Provider that you or another Administrator has already created, the additional User Profile Service Provider Configuration properties for the Identity Directory Service connection appears.

The additional User Profile Service Provider Configuration properties are as follows:

**Name** - The name of this User Profile Service Provider.

**Description** - (Optional) Type a short description that will help you or another Administrator identify this service in the future.

#### Attributes

Add or delete User Profile Service Provider Attributes and their values.

See [Table 49-8](#) for details.

---



---

#### Note:

LDAP attribute names are generally not case sensitive but when communicating with the Oracle Identity Governance Framework (IGF), LDAP attribute names *are* case sensitive.

---



---

**Table 49-9 User Profile Service Provider Default Attribute Names and Values**

Name	Default Value	Notes
<code>accessControl</code>	<code>false</code>	Supported values include <b>true</b> or <b>false</b> (enable/disable, respectively) depending on whether the accessControl feature is to be disabled or enabled.

**Table 49-9 (Cont.) User Profile Service Provider Default Attribute Names and Values**

Name	Default Value	Notes
adminGroup	cn=Administrators,ou=groups,ou=myrealm,dc=base_domain	If accessControl is enabled, specify the distinguished name (DN) of the adminGroup to see if the User is in it.
selfEdit	true	Supported values include <b>true</b> or <b>false</b> depending on if the User can edit his or her profile for the accessControl feature. This is also one of the accessControl feature's configuration properties.
proxyAuth	true	Supported values include <b>true</b> or <b>false</b> depending on if the proxyAuth feature is enabled or disabled, respectively. This attribute is required only if proxyAuth is supported and the Administrator does not want to use the proxyAuth feature.  This attribute is not included in a new installation of Mobile and Social. An Administrator can add this property.

### Identity Directory Service

**Name** - The Identity Directory Service profile that connects the User Profile Service Provider to one or more directory servers. For more information about the Identity Directory Service.

See [Managing the Identity Directory Service User Identity Stores](#).

- If either of the default Identity Directory Services are selected (either `userrole` or `idxuserrole`) you cannot view or edit the configuration values.
- If an Identity Directory Service connection that you or another Administrator created is selected, you can view and edit the configuration values as needed.

### Relationship Configuration

Type the URI segment used to access the corresponding column in the Identity Directory Service. Use **Add** to add a new relationship or **Remove** to remove a configured relationship.

- **Access URI** - Type a URI segment that will be used to access a corresponding data column in the Identity Directory service. For example, if `memberOf` is the Access URI, then:

```
http://host:port/.../idX/memberOf
```

would be the URI to access related entities of an entity with ID `idX`.

- **Identity Directory Service Relation** - Choose the Directory Service relationship that is to be accessed by the **Access URI** segment. You can configure relationships on the **Relationships** tab in the **Identity Directory Service** configuration section



provided that the Identity Directory Service *is not* the pre-configured UserProfile Identity Provider. (You cannot configure Identity Directory Service relationships for the *UserProfile* Service Provider.)

- **Entity URI Attribute** - Type the JSON attribute name to be used in the URI response sent from the Mobile and Social server. For example, if *person-uri* is the specified entity URI attribute, the URI response would be as follows:

```
{ {"person-uri":uriY1, ...}, {"person-uri":uriY2, ...}, ... }
```

where *uriY1* and *uriY2* are the direct URIs to access each of the related entities.

- **Scope for Requesting Recursion** - Use Scope attribute values with the scope query parameter to retrieve a nested level of attributes in a relationship search. To access related entities recursively, type the value to be used. The Mobile and Social default configuration uses two scope attribute values: *toTop* and *all*. If the **Scope for Requesting Recursion** value is the attribute value *all*, then the following REST URI example is used to make the request:

```
http://host:port/.../idX/reports?scope=all
```

In this example, the URI returns the entities related to the entity with ID *idX*, as well as all further related entities.

#### 49.3.3.4 Pre-Configured User Profile Service Provider

Mobile and Social provides a pre-configured User Profile Service Provider for LDAP-compliant directory servers named *UserProfile*.

This Service Provider allows lookup and update tasks to be performed on directory objects using Mobile and Social.

## 49.4 Defining Service Profiles

A *Service Profile* defines a Service Endpoint URL for a Service Provider on the Mobile and Social server.

Each Service Provider instance requires at least one corresponding Service Profile instance. You can create multiple Service Profiles for a single Service Provider; each Service Profile will define different token capabilities and service endpoints for the Service Provider.

---



---

### Note:

One Service Profile can be assigned to multiple Service Domains. In general, mobile Service Profiles should be assigned to mobile Service Domains, and non-mobile Service Profiles should be assigned to non-mobile Service Domains. See [Defining Service Domains](#).

---



---

Add one or more Service Profiles after having created the required Service Provider(s).

You need to familiarize yourself with the following topics to define Service Profiles:

- [Defining, Modifying, and Deleting an Authentication Service Profile](#)
- [Defining, Modifying and Deleting an Authorization Service Profile](#)
- [Defining, Modifying and Deleting a User Profile Service Profile](#)

## 49.4.1 Defining, Modifying, and Deleting an Authentication Service Profile

You can define, modify, and deleting an Authentication Service Profile.

The following topics include information about Authentication Service Profiles:

- [Creating an Authentication Service Profile](#)
- [Editing or Deleting an Authentication Service Profile](#)

### 49.4.1.1 Creating an Authentication Service Profile

You can create an Authentication Service Profile and modify its attributes and values.

To create:

1. Access the Mobile and Social Services configuration page.  
See [Opening the Mobile and Social Services Configuration Page](#).
2. Click **Create** in the **Service Profiles** section and choose **Create Authentication Service Profile**.

The Authentication Service Profile Configuration page displays.

3. Enter values for the Authentication Service Profile general properties.

**Table 49-10 Authentication Service Profile Default General Properties**

Name	Notes
Name	Type a unique name for this Authentication Service Profile.
Description	(Optional) Type a short description that will help you or another Administrator identify this service in the future.
Service Type	Shows the type of Service Profile that you are creating (either a <b>User Profile Service</b> , an <b>Authentication Service</b> , or an <b>Authorization Service</b> ).The value is read-only.
Service Endpoint	<p>Create a unique uniform resource identifier (URI) address for this service by typing a string in the box; for example, <code>localhost:5575</code>.</p> <ul style="list-style-type: none"> <li>• If creating an <i>Authentication Service</i> Profile, the <b>URI Category Information</b> section shows the URIs that will be created to create, validate, manage, and delete the Profile's client, user, and Access Tokens, as well as the "Client Registration Handle" URI that is used to register devices.</li> <li>• If creating an <i>Authorization Service</i> Profile, the <b>URI Category Information</b> section shows the authorization URI category that will be created on the Service.</li> <li>• If creating a <i>User Profile Service</i> Profile, the <b>URI Category Information</b> section shows the URI categories that will be created on the Service (one URI to manage Users, and another to manage Groups).</li> </ul>
Service Provider	Choose the Service Provider on which this Service Profile should be based. The contents of this list are determined by the Service Type. A Service Provider must be defined before you can create a corresponding Service Profile.

**Table 49-10 (Cont.) Authentication Service Profile Default General Properties**

Name	Notes
Service Enabled	Select the box to enable the service; clear the box to disable.

- Select an option under Token Support and URI Category Information to enable support for the token type on the service, or clear the option box to disable support for the token type on the service.

Token Support applies to Authentication Service Profiles only. The corresponding uniform resource identifier (URI) is listed alongside each token type.

**Table 49-11 Token Support and URI Category Information Default Properties**

Name	Notes
Client Registration Handle	Required for mobile token services so that the client device can register with the Mobile and Social server. The server issues a Client Registration Handle after authenticating the user. When OAAM and its Security Handler Plug-in is used in conjunction with a mobile Authentication Service, the Plug-in can run fraud detection and risk analysis policy checks, enhancing authenticity and the trust level of a client. To add an Authentication Service Profile to a mobile Service Domain, Client Registration Handle must be enabled. Client Registration Handles are not used in non-mobile Service Domains.
Client Token	Select to enable Client Tokens on the Service. A Client Token is a security grant issued by the Mobile and Social server to prove that a non-mobile device or client is authenticated. The server issues a Client Token after authenticating the client based on a name and password or other credentials. Client Tokens are optional in non-mobile Service Domains. They are not used in mobile Service Domains.
User Token	Select to enable User Tokens on the Service. A User Token is a security grant issued by the Mobile and Social server to prove that a user is authenticated. A User Token can be used to request an Access Token.
Access Token	Select to enable Access Tokens on the Service. An Access Token is a security grant issued by the Mobile and Social server so that a client application can access a specific protected resource. A client application can get an Access Token by presenting a User Token, provided that the user is authorized to access the resource.

- Click Create to create the Service Profile configuration object.

#### 49.4.1.2 Editing or Deleting an Authentication Service Profile

You can edit or delete an Authentication Service Profile.

Select the Service Profile in the panel and click **Edit** or **Delete** on the panel's tool bar.

### 49.4.2 Defining, Modifying and Deleting an Authorization Service Profile

The following topics include information regarding Authentication Service Profiles:

- [Creating an Authorization Service Profile](#)

- [Editing or Deleting an Authorization Service Profile](#)

#### 49.4.2.1 Creating an Authorization Service Profile

You create an Authorization Service Profile from the Mobile and Social Services configuration page.

To create:

1. Access the Mobile and Social Services configuration page.  
See [Opening the Mobile and Social Services Configuration Page](#).
2. Click **Create** in the **Service Profiles** section and choose **Create Authorization Service Profile**.

The Authorization Service Profile Configuration page displays.

3. Enter values for the Authorization Service Profile general properties.

**Table 49-12 Authorization Service Profile Default General Properties**

Name	Notes
Name	Type a unique name for this Authorization Service Profile.
Description	(Optional) Type a short description that will help you or another Administrator identify this service in the future.
Service Type	Shows the type of Service Profile that you are creating (either a <b>User Profile Service</b> , an <b>Authentication Service</b> , or an <b>Authorization Service</b> ).The value is read-only.
Service Endpoint	Create a unique uniform resource identifier (URI) address for this service by typing a string in the box; for example, localhost:5575. <ul style="list-style-type: none"> <li>• If creating an <i>Authentication Service</i> Profile, the <b>URI Category Information</b> section shows the URIs that will be created to create, validate, manage, and delete the Profile's client, user, and Access Tokens, as well as the "Client Registration Handle" URI that is used to register devices.</li> <li>• If creating an <i>Authorization Service</i> Profile, the <b>URI Category Information</b> section shows the authorization URI category that will be created on the Service.</li> <li>• If creating a <i>User Profile Service</i> Profile, the <b>URI Category Information</b> section shows the URI categories that will be created on the Service (one URI to manage Users, and another to manage Groups).</li> </ul>
Service Provider	Choose the Service Provider on which this Service Profile should be based. The contents of this list are determined by the Service Type. A Service Provider must be defined before you can create a corresponding Service Profile.
Service Enabled	Select the box to enable the service; clear the box to disable.

4. Click **Create** to create the Service Profile configuration object.

#### 49.4.2.2 Editing or Deleting an Authorization Service Profile

You can edit or delete an Authorization Service Profile.

To edit or delete:

1. Select the Service Profile in the panel.
2. Click Edit or Delete on the panel's tool bar.

### 49.4.3 Defining, Modifying and Deleting a User Profile Service Profile

The following topics include information about Authentication Service Profiles:

- [Creating a User Profile Service Profile](#)
- [Editing or Deleting a User Profile Service Profile](#)

#### 49.4.3.1 Creating a User Profile Service Profile

To create a User Profile Service Profile:

1. Access the Mobile and Social Services configuration page.

See [Opening the Mobile and Social Services Configuration Page](#)

2. Click **Create** in the **Service Profiles** panel in the home area and choose **Create User Profile Service Profile**.

The User Profile Service Profile Configuration page displays.

3. Enter values for the User Profile Service Profile general properties.

**Table 49-13** *User Profile Service Profile Default General Properties*

Name	Notes
Name	Type a unique name for this Authorization Service Profile.
Description	(Optional) Type a short description that will help you or another Administrator identify this service in the future.
Service Type	Shows the type of Service Profile that you are creating (either a <b>User Profile Service</b> , an <b>Authentication Service</b> , or an <b>Authorization Service</b> ).The value is read-only.
Service Endpoint	Create a unique uniform resource identifier (URI) address for this service by typing a string in the box; for example, <code>localhost:5575</code> . <ul style="list-style-type: none"> <li>• If creating an <i>Authentication Service</i> Profile, the <b>URI Category Information</b> section shows the URIs that will be created to create, validate, manage, and delete the Profile's client, user, and Access Tokens, as well as the "Client Registration Handle" URI that is used to register devices.</li> <li>• If creating an <i>Authorization Service</i> Profile, the <b>URI Category Information</b> section shows the authorization URI category that will be created on the Service.</li> <li>• If creating a <i>User Profile Service</i> Profile, the <b>URI Category Information</b> section shows the URI categories that will be created on the Service (one URI to manage Users, and another to manage Groups).</li> </ul>

**Table 49-13 (Cont.) User Profile Service Profile Default General Properties**

Name	Notes
Service Provider	Choose the Service Provider on which this Service Profile should be based. The contents of this list are determined by the Service Type. A Service Provider must be defined before you can create a corresponding Service Profile.
Service Enabled	Select the box to enable the service; clear the box to disable.

- Click Create to create the Service Profile configuration object.

#### 49.4.3.2 Editing or Deleting a User Profile Service Profile

To edit or delete a User Profile Service Profile:

- Select the Service Profile in the panel.
- Click Edit or Delete on the panel's tool bar.

## 49.5 Defining Security Handler Plug-ins

A *Security Handler Plug-in* enhances security by consulting additional logic for trust and risk analysis.

Such additional logic may deny access based on certain risky operations. Mobile authentication invokes the Security Handler Plug-in during sensitive security operations; for example, during virtually all token acquisition operations including client application registration.

---



---

#### Note:

Security Plug-in usage is optional. If used, it should only be applied to mobile-related Service Domains and its authentication services and client applications.

---



---

Mobile and Social includes the following pre-configured Security Handler Plug-ins.

- `OAAMSecurityHandlerPlugin` enables sophisticated device and client application registration logic as well as the advanced risk and fraud analysis logic found in OAAM.
- `Default` offers very limited risk analysis logic.

The following topics include information about defining Security Handler Plug-ins:

- [Creating a Security Handler Plug-in](#)
- [Editing or Deleting a Security Handler Plug-in](#)
- [Device Fingerprinting and Device Profile Attributes](#)

### 49.5.1 Creating a Security Handler Plug-in

You can create a security handler plug-in from the Mobile and Social Services configuration page.

To create:

1. Access the Mobile and Social Services configuration page.  
See [Opening the Mobile and Social Services Configuration Page](#).
2. Click **Create** in the **Security Handler Plug-ins** section.  
The Security Handler Plug-in Configuration page displays.
3. Enter values for the Security Handler Plug-in general properties.

**Table 49-14 Security Handler Plug-in General Properties**

Name	Notes
Name	Type a unique name for this Authorization Service Profile.
Description	(Optional) Type a short description that will help you or another Administrator identify this service in the future.
Security Handler Class	Choose the Java class that defines the Security Handler Plug-in that you want to use. This release of Mobile and Social supports two Security Handler Plug-ins, the <code>DefaultSecurityHandlerPlugin</code> and the <code>OAAMSecurityHandlerPlugin</code> .

4. Enter name-value pairs for the Security Handler Plug-in Attributes.
  - See [Setting Up OTP E-Mail Integration](#) for descriptions of the `OaamSecurityHandlerPlugin` attributes.
  - The `DefaultSecurityHandlerPlugin` has a single attribute setting, `allowJailBrokenDevices`. This specifies if jail-broken client devices should be allowed or denied access to protected resources. Set the attribute's value to `false` to deny access (default setting) or set it to `true` to allow access. The `OAAMSecurityHandlerPlugin` does not need to be configured for jailbreak enforcement.  
See [Creating a New Jailbreak Detection Policy with the Oracle Access Management Console](#).
5. Click **Create** to create the Security Handler Plug-in configuration object.

### 49.5.2 Editing or Deleting a Security Handler Plug-in

You can edit or delete a Security Handler Plug-in.

Select the definition in the panel and click **Edit** or **Delete** on the panel's tool bar.

### 49.5.3 Device Fingerprinting and Device Profile Attributes

When a mobile application is started, Mobile Client SDK logic in the application will attempt to detect a number of Device Profile attributes. A particular combination of Device Profile attribute values is treated as a device finger print.

Some Device Profile attributes are general attributes that cannot uniquely identify a device, such as OS Type, OS Version, language locale setting, network setting, and geographic location. Some attributes are hardware identifiers that can uniquely identify a device. An example of a hardware identifier is a MAC Address on a mobile device. The mobile OS type and version will dictate the kinds of Device Profile attributes that can be detected.

When a mobile application requests a token through the Mobile Client SDK, the SDK logic will send the Device Profile attributes as a part of an HTTP request. This set of Device Profile attributes enhances security by creating an audit trail for devices that assists device identification.

When the OAAM Security Plug-in is used, a particular combination of Device Profile attribute values is treated as a device finger print, known as the *Digital Finger Print* in the OAAM Administration Console. Each finger print is assigned a unique fingerprint number. Each OAAM session is associated with a finger print and the finger print makes it possible to log (and audit) the devices that are performing authentication and token acquisition.

## 49.6 Defining Application Profiles

An *Application Profile* defines the client application that will consume services provided by the Service Providers.

A single Application Profile can be assigned to multiple Service Domains.

The following topics include information on how to define Application Profiles:

- [Creating an Application Profile](#)
- [Editing or Deleting an Application Profile](#)

### 49.6.1 Creating an Application Profile

You can create an application profile from the Mobile and Social Services configuration page.

To create:

1. Access the Mobile and Social Services configuration page.

See [Opening the Mobile and Social Services Configuration Page](#).

2. Click **Create** in the **Application Profiles** section.

The Application Profiles Configuration page displays.

3. Enter values for the Application Profile general properties.

**Table 49-15 Application Profile General Properties**

Name	Notes
Name	The value must be a unique one that distinguishes the application from all other applications on the server. This value and the application name value embedded in the client application must match.
Description	(Optional) Type a short description that will help you or another Administrator identify this service in the future.

4. Enter name-value pairs for the attributes used by the Mobile and Social server to perform server functions for this application; for example, creating a Client Registration Handle.



- **Mobile.clientRegHandle.baseSecret** is a mandatory attribute used by the server as a private secret to sign each Client Registration Handle for this application.
  - **userId4BasicAuth** is the user ID attribute used by the server and the application to perform HTTP Basic authentication.  
See [Protecting the Mobile Client Registration Endpoint](#).
  - **sharedSecret4BasicAuth** is the shared secret attribute used by the server and application to perform HTTP Basic authentication.
5. Define the Mobile Application Profile properties.
    - **Jailbreak Detection** - Select the **Enabled** box to activate Jailbreak Detection for this application, or clear the box to disable it. If Jailbreak Detection is grayed out, the Jailbreak Detection Policy is disabled in Mobile and Social.  
See [Using the Jailbreak Detection Policy](#).
    - **Mobile Configuration** - Select this option to expose additional mobile configuration settings on the Application Profile Configuration page.
  6. Click **Create** to create the Application Profile configuration object.  
See [Editing or Deleting an Application Profile](#) for information about properties that you can configure only after you have already created an Application Profile.

## 49.6.2 Editing or Deleting an Application Profile

You can edit or delete an Application Profile.

To edit or delete an Application Profile:

1. Select the definition in the panel.
2. Click Edit or Delete on the panel's tool bar.

## 49.6.3 Application Profile Properties

When you edit a User Profile Service Provider that you or another Administrator has already created, the additional Application Profile properties appears.

The additional Application Profile properties are as follows:

- **Configuration Settings**
  - **Profile Cache Duration** - The maximum amount of time that the Application Profile details cached on the mobile device will remain valid. If the time is elapsed when the mobile client application requests the Application Profile, the cached Profile is replaced with a freshly downloaded version. If the time is not elapsed, the cached Profile is used.
  - **Authentication Retry Count** - The maximum number of retries that a User is allowed if invalid credentials are provided during registration/authentication. This setting is not honored in the iOS Mobile SDK.
  - **Offline Authentication** - Select the **Allowed** box to allow users to log in and authenticate to the application locally. Clear the box to block users from authenticating locally.

- **Claim Attributes** - The set of attributes that will be fetched from the device and passed to the server during registration/authentication.
- **Social Identity WebView** - Choose **Embedded** if users should be presented with the Mobile and Social login page inside the application using the embedded WebView class, or choose **External** if the login page should be presented in an external browser.
- **Platform Specific Settings**
  - **URL Scheme** - Type the URL scheme that is used to invoke this mobile client application, as configured in the application itself.
  - **Apple iOS Bundle ID** - Type the unique Bundle ID that is configured in the mobile client application. Each iOS mobile application has a unique Bundle ID.
  - **Android Package** - Type the fully qualified name of an activity in the Android application. This activity should have `<data android:scheme="xyz" />` in its `<intent-filter>`.

---

**Note:**

The scheme (xyz) should be the same as the URL scheme.

---

For details regarding the `<data>` element, please see the following web page:

<http://developer.android.com/guide/topics/manifest/data-element.html>

- **Android Application Signature** - Enter the signature of the Android application. You can obtain the signature from the certificate with which the application is signed. On Linux, you can obtain the signature using the following command:

```
keytool -exportcert -alias <alias_name> -keystore
<keystore_name> -storepass <keystore_password> | xxd -c 256
-ps
```

---

**Note:**

The signature obtained using the above command will have a carriage return after 256 characters. Remove it before entering the signature in this field.

---

You can also retrieve the signature programmatically.

See "Invoking the Mobile Single Sign-on Agent App" in the *Oracle Fusion Middleware Developer's Guide for Oracle Access Management*.

- **Custom Settings / Mobile Custom Attributes** - Configure attributes or properties specific to the mobile client application. Mobile Custom Attributes are returned by the server to the mobile application as part of the Application Profile

## 49.7 Defining Service Domains

You need to create a *Service Domain* to associate Service Profiles with Application Profiles and the corresponding configuration settings.

When the Create Service Domain page is displayed, you can:

- Choose if the Service Domain is for managing mobile applications or desktop applications.
- Choose an authentication scheme and, optionally, a Security Handler Plug-in for the Service Domain.
- Add one or more Mobile SSO Agents to the Service Domain and configure which agents have priority over others.
- Add one or more applications to the Service Domain and configure which applications can use a Mobile SSO Agent.
- Choose at least one Service Profile for the Service Domain.
- Configure security settings to protect the Service Domain's selected services.

See [Creating a Service Domain](#).

See [Editing or Deleting a Service Domain](#).

### 49.7.1 Creating a Service Domain

You can create a service domain from the Mobile and Social Services configuration page.

To create a service domain:

1. Access the Mobile and Social Services configuration page.  
See [Opening the Mobile and Social Services Configuration Page](#).
2. Click **Create** in the **Service Domains** panel in the home area.  
The Create Service Domain Configuration page displays.
3. Enter values for the Service Domain general properties.

**Table 49-16** *Service Domain General Properties*

Name	Notes
Name	Type a unique name for this Service Domain.
Description	(Optional) Type a short description that will help you or another Administrator identify this service in the future.
Type	Choose <b>Mobile Application</b> or <b>Desktop Application</b> . A <i>mobile application</i> is an application that runs on a mobile operating system, such as the Android or iOS operating systems. A <i>desktop application</i> is an application that runs on a non-mobile operating system.

**Table 49-16 (Cont.) Service Domain General Properties**

Name	Notes
Credential for Registering an Application	If configuring a mobile Service Domain, choose the minimum credential level required to register an application. If you choose <b>User Password</b> , the server will prompt the User for a user name and password every time an application is registered, even if a mobile single sign-on agent is installed on the device. If you choose <b>User Token</b> , the server asks the mobile SSO agent to provide the User name and password. Subsequent application registrations on that device then will use the User Token issued to the mobile SSO agent for that purpose. User Password provides added security around the application registration process. User Token makes the application registration process more convenient for the User.
Authentication Scheme	If configuring a mobile Service Domain, choose <b>Mobile Service Authentication</b> or <b>Social Identity Authentication</b> . If you choose <i>Mobile Service Authentication</i> , the client will prompt the User for a User name and password. If you choose, <i>Social Identity Authentication</i> , the client will redirect to the Mobile and Social server and the User will use Social Identity to authenticate with an Identity Provider, for example Google or Facebook. This selection determines which Authentication Service Profiles you can choose on the <b>Service Profile Selection</b> configuration screen.
Security Handler Plug-in Name	<b>Security Handler Plug-in Name</b> - If configuring a mobile Service Domain, choose the Security Handler Plug-in to use. For information about the available Security Handler Plug-ins, see <a href="#">Security Handler Plug-ins</a> .

4. Use one or all of the following options to add or select Application Profiles.
 

If configuring a mobile domain, only mobile apps can be selected. Similarly, if configuring a non-mobile domain, only desktop apps can be selected

  - a. Click **Browse Application Profiles** (under Application Profile Selection) to open a Search window from which you can search for one or more previously configured Application Profiles to add to the Service Domain. Select the Profiles to add and click **Select**.
  - b. Alternately, if you know the exact name of the Application Profile, click **Add** and type the name directly into the table.

**Table 49-17 Application Profile Selection Properties**

Name	Notes
Application Profile Name	The name that uniquely identifies the client application to Mobile and Social.

**Table 49-17 (Cont.) Application Profile Selection Properties**

Name	Notes
Mobile Single Sign-on (SSO) Configuration	<p>If configuring a mobile Service Domain, choose if each application should participate in mobile single sign-on as an SSO Agent, as an SSO Client, or not at all (None).</p> <ul style="list-style-type: none"> <li>Choose <b>None</b> if this application does not want to participate in mobile SSO and instead wants to perform User authentication with the Mobile and Social server directly.</li> <li>Choose <b>As an SSO Agent</b> if the application is a mobile single sign-on agent that can accept authentication requests from other apps. For details about creating a custom mobile SSO agent, refer to the Android or iOS SDK information in the <i>Oracle Fusion Middleware Developer's Guide for Oracle Access Management</i>.</li> <li>Choose <b>As an SSO Client</b> if the application is configured to work with mobile single sign-on and it delegates user authentication and user session management responsibilities to a mobile SSO agent.</li> </ul>
Agent Priority	<p>Displays the numerical ranking for applications that are configured as mobile SSO Agents. When multiple agent apps are installed on the device, the Agent application with highest priority (smallest numerical rank) acts as the Agent application for all other Agent apps. If that Agent is deleted from the device, the Agent with the next highest ranking becomes the active Agent. Click <b>Move Up</b> and <b>Move Down</b> to reorder the agents by priority.</p>
Description	(Optional) Type a short description that will help you or another Administrator identify this service in the future.

- Click **Next** to select a Service Profile.

The Service Profile page displays.

- Use one or both of the following options to add at least one Service Profile to the Service Domain.

For a mobile Service Domain, you can add one Service Profile for each authentication, authorization, and User Profile Services Service Provider. For a non-mobile Service Domain, you can add multiple Service Profiles for each authentication, authorization, and User Profile Services Service Provider.

- Click **Select** to open a Search window from which you can search for a previously configured Service Profile. If configuring a mobile Domain, you can only select a mobile-compatible Authentication Service Profile. Similarly, if configuring a non-mobile domain, you can only select a desktop-compatible Authentication Service Profile. Select the Profile to assign and click **Select**. If you know the exact name of the Service Profile, click **Add** and type the name directly into the table.
- Click **Create** to create a new Service Profile.

**Table 49-18 Service Profile Selection Properties**

Name	Notes
Authentication Service	(Optional) Displays the name of the Authentication Service Profile configured for this Service Domain and the corresponding Service Endpoint. If creating a new Service Profile, see <a href="#">Defining, Modifying, and Deleting an Authentication Service Profile</a>
Authorization Service	(Optional) Displays the name of the Authorization Service Profile configured for this Service Domain and the corresponding Service Endpoint. If creating a new Service Profile, see <a href="#">Defining, Modifying and Deleting an Authorization Service Profile</a>
User Profile Service	(Optional) Displays the name of the User Profile Service Profile configured for this Service Domain and the corresponding Service Endpoint. If creating a new Service Profile, see <a href="#">Defining, Modifying and Deleting a User Profile Service Profile</a>

7. Click **Next** to configure Service Protection (authentication).  
The Service Protection page displays.
8. Configure authentication for the Service Profile using one of the following options.
  - a. If you previously selected a User Profile Service for this Service Domain, configure the security settings to protect it.

**Table 49-19 User Profile Service Protection Properties**

Name	Notes
Authentication	Choose from the menu the Authentication Service Profile configured for this Service Domain, with which you would like to protect this User Profile service.
Secured Application	Select to require the client application to authenticate, either by presenting a Client Resource Handle or a Client Token.
Secured User	Select to require a User to authenticate, either by presenting a User Token or an Access Token, where the access token is previously acquired with a User Token.
Allow Read	Select to allow users to view User Profile data.
Allow Write	Select to allow users to update User Profile data.

- b. If you previously selected an Authorization Service for this Service Domain, configure the security settings to protect it.

**Table 49-20 Authorization Service Protection Properties**

Name	Notes
Authentication	Choose the Authentication Service Profile configured for this Service Domain, with which you would like to protect this Authorization service.
Secured Application	Select to require the client application to authenticate, either by presenting a Client Resource Handle or a Client Token.
Secured User	Select to require a User to authenticate, either by presenting a User Token or an Access Token, where the access token is previously acquired with a User Token.

9. Click **Next** to verify your selections.
10. Click **Finish** to create the Service Domain.

### 49.7.2 Editing or Deleting a Service Domain

You can edit or delete a Service Domain.

To edit or delete:

1. Select the definition in the panel.
2. Click **Edit** or **Delete** on the panel's tool bar.

## 49.8 Using the Jailbreak Detection Policy

Jailbreaking is the process of removing or circumventing the limitations that manufacturers impose on their mobile devices. While legal, jailbreaking can present a heightened security risk to protected resources. To counter this risk, Mobile and Social provides a preconfigured Jailbreak Detection Policy for iOS devices.

The Jailbreak Detection Policy consists of one or more statements that instruct a client application (built using the Mobile and Social SDK for iOS) to search for files that may indicate the device is jailbroken. The Mobile and Social server sends the Policy statements to the iOS client application. The client device then returns a *true* (jailbreaking is detected) or *false* value back to the Mobile and Social server. This value is forwarded to the Security Handler Plug-in and, depending on the security policies of the Security Handler Plug-in in use, Mobile and Social can allow access, deny access, or wipeout any Mobile and Social specific data from the application.

- If the *Default* Security Handler Plug-in is active and the policy logic says the device is jail broken, the Plug-in can ALLOW or DENY access to the client device depending on how the `allowJailBrokenDevices` Plug-in attribute is set.
- If the *Oaam* Security Handler Plug-in is active and the policy logic says the device is jail broken, the Plug-in can ALLOW or BLOCK access to the client device depending on how the OAAM policy rules are configured.

Additionally, if a device is blacklisted, lost or stolen, this Plug-in can send a WIPEOUT command that will delete any Mobile and Social specific data from the device and block the device from future requests. If the user recovers the missing device, the device can be reset in OAAM.

See [Defining Security Handler Plug-ins](#).

---

---

**Note:**

OAAM's BLOCK and Mobile and Social's DENY mean the same thing.

---

---

The following topics include additional information.

- [Creating a New Jailbreak Detection Policy with the Oracle Access Management Console](#)
- [Editing a Jailbreak Detection Policy](#)

## 49.8.1 Creating a New Jailbreak Detection Policy with the Oracle Access Management Console

You can create a new Jailbreak Detection Policy with the Oracle Access Management Console from the Mobile and Social Services configuration page.

If you choose to create a new Jailbreak Detection Policy using XML, click the **Load** button to overwrite the default Policy completely. A schema file is available from customer support.

To create a new Jailbreak Detection Policy:

1. Access the Mobile and Social Services configuration page.

See [Opening the Mobile and Social Services Configuration Page](#).

2. Click **Jailbreak Detection Policy** in the navigation pane.

The **Jailbreak Detection Policy** page displays.

3. Click Add to configure the Conditions and Detection Logic properties for a new **Jailbreak Detection Policy**.
  - **Jailbreak Detection** - Select **Enabled** to turn the Jailbreak Detection Policy on, or clear this option to turn it off for all client Application instances. If you enable the Jailbreak Detection Policy here, you can disable it on an application by application basis. If you disable the Policy here, you cannot enable or disable the feature on an application by application basis.
  - **Min OS Version** - The minimum iOS version to which the policy applies. If the value is 1.0, the policy will apply to iOS devices running at least version 1.0 of iOS.
  - **Max OS Version** - The maximum iOS version to which the policy applies. If the value is empty, a maximum iOS version number is not checked so the policy applies to any iOS version higher than the value specified for Min OS Version.
  - **Min Client SDK Version** - The minimum Mobile and Social Client SDK version number. For example, 11.1.2.0.0.
  - **Max Client SDK Version** - The maximum Mobile and Social Client SDK version number. For example, 11.1.2.3.0.
  - **Policy Expiration Duration** - Type the length of time in seconds that the SDK on the iOS client device should wait before expiring the local copy of the policy and retrieving a newer version.



- **Auto Check Period** - Type the interval of time in minutes that the iOS client device should wait before executing the Jailbreak Detection Policy statements again.
- **Detection Location** - The iOS client device uses a logical-OR operator to evaluate Policy statements. Add a Detection Location as follows:
  - **File Path** - Type the absolute path to the file or directory on the device for which the Detection Policy should search.
  - **Action** - Select **Exists** which instructs the Detection Policy to evaluate whether it can access a file path.
  - **Success** - Select if the Policy should flag the device as jail broken if the specified files or directories are found on the device. Use this option if the policy is checking for unauthorized files or directories. Clear this option if the Policy should flag the device as jail broken if the specified files or directories are *not* found. (Use this option if checking for *required* files or directories.)

## 49.8.2 Editing a Jailbreak Detection Policy

In most cases you can use the **Policy Statements** editor on the Jailbreak Detection Policy Configuration page to change a Jailbreak Detection Policy.

To edit a Jailbreak Detection Policy:

1. Access the Mobile and Social Services configuration page.

See [Opening the Mobile and Social Services Configuration Page](#).

2. In the **Jailbreak Detection Policy** section, select one of the following:

- To append changes to the Jailbreak Detection Policy, click **Load** in the tool bar, browse to the XML file that contains the Jailbreak Detection Policy statements that you want to append, choose **Append after existing policy statements**, and click OK. A schema file is available from customer support.
- To overwrite the Jailbreak Detection Policy, click **Load** in the tool bar, browse to the XML file that contains the Jail-Breaking Detection Policy statements that you want to load, choose **Overwrite existing policy statements**, and click OK. A schema file is available from customer support.
- To edit the Jailbreak Detection Policy, select it in the Policy Statements table to display its properties, make changes.

See [Creating a New Jailbreak Detection Policy with the Oracle Access Management Console](#).

3. Click **Apply**.

## 49.9 Configuring Mobile and Social Services with Other Oracle Products

The following topics include information on how to configure Mobile and Social with other Oracle products:

- [Configuring Mobile and Social Services for Access Manager](#)
- [Configuring Mobile and Social Services for Oracle Adaptive Access Manager](#)

## 49.9.1 Configuring Mobile and Social Services for Access Manager

The following topics describe how to configure Mobile and Social to work with different versions of Access Manager:

- [Configuring Mobile and Social Services to Work With Access Manager in Simple and Certificate Mode](#)
- [Configuring an Authentication Service Provider for Remote Oracle Access Manager Server 10g](#)
- [Configuring an Authentication Service Provider for Remote Access Manager 11gR2 or Oracle Access Manager 11gR1 PS1](#)

---

---

**Note:**

During installation, the Oracle Fusion Middleware Configuration Wizard generates a domain that supports both Mobile and Social and Access Manager.

See "Configuring Mobile and Social" in the *Oracle Fusion Middleware Installation Guide for Oracle Identity and Access Management*.

---

---

### 49.9.1.1 Configuring Mobile and Social Services to Work With Access Manager in Simple and Certificate Mode

You can configure Mobile and Social Services to work with Access Manager if Access Manager is configured in Simple Mode.

Change the Server Mode to Simple

1. In the Oracle Access Management Administration Console, click **Configuration** at the top of the window.
2. Click **Server Instances**. Click **Search** and click `oam_server1` in the Search Results.
3. Click **Open**.
4. In the **OAM Proxy** section, choose **Simple** from the **Mode** menu and click **Apply**.

Change the Webgate Communication Mode to Simple

1. In the Oracle Access Management Administration Console for the target Webgate, click **Application Security** at the top of the window.
2. In the **Webgates** tab, click **Search**.
3. Select the target Webgate and open it for editing.
4. Change the security mode for the Webgate to **Simple**, then click **Apply**.

The system creates a new directory for the Webgate under `~/oam-domain/output/accessgate-oic` with the following files:

- `aaa_cert.pem`
- `aaa_key.pem`

- `cwallet.sso`
- `ObAccessClient.xml`
- `password.xml`

Change the OIC OAMASDKAuthNProvider Security Mode to Simple

1. Copy the `.jks` files from the `~/oam-domain/output/webgate-ssl` directory to the `~/oam-domain/config/fmwconfig` directory.
2. Go to the `~/oam-domain/output/accessgate-oic` directory and open `password.xml`.

Copy the `passwd` value from the file.

3. Open the Oracle Access Management Administration Console.

The Launch Pad opens.

Go to the **Mobile and Social** panel and click **Mobile and Social Services > Service Providers > Authentication Service Providers > OAMAuthentication**.

4. Add the following name-value pairs to the Attributes table.

Name	Value
PASSPHRASE	The <code>passwd</code> value from step 2.
KEYSTORE	<i>&lt;fully qualified path&gt;</i> /oam-domain/config/fmwconfig/oamclient-keystore.jks
TRUSTSTORE	<i>&lt;fully qualified path&gt;</i> /oam-domain/config/fmwconfig/oamclient-truststore.jks

5. In the **Attributes** table, locate `TRANSPORT_SECURITY` and change the value from `OPEN` to `SIMPLE` or `CERT` and click **Save**.
6. Restart the Oracle Access Management server.

#### 49.9.1.2 Configuring an Authentication Service Provider for Remote Oracle Access Manager Server 10g

You need to configure an Authentication Service Provider to work with a remote instance of the Oracle Access Manager 10g server.

To configure an authentication service provider for remote Oracle Access Manager server 10g:

1. Log into the 10g Console and create the WG Profile.  
The OAM 10g Access Management Service must be turned on.
2. Navigate through the Mobile and Social Console to **Mobile and Social Services > Service Providers > Authentication Service Providers**.
3. Click **New** to create a new Authentication Service Provider configuration.
4. Enter the appropriate values for the parameters.
  - a. Change `OAM_VERSION` to `OAM_10G` from `OAM_11G`.

- b. Change `WEBGATE_ID` to the name you previously used to create the WG profile.
  - c. Change `OAM_SERVER_1` to the *hostname:port#* of the machine hosting the OAM 10G server.
  - d. Add a new parameter named `AuthNURL` and populate it with the URL for any protected resource; for example, `http://server1.example.com/index.html`.
5. Save the Authentication Service Provider configuration.
  6. Navigate through the Mobile and Social console to Mobile and Social Services > Service Profiles > Authentication Services > OAMAuthentication.
  7. From the Service Provider drop down menu, select the Authentication Service Provider just created; for example, `10GOAMAuthentication`.
  8. Check the **Client Token** checkbox.
  9. Uncheck the **Access Token** checkbox.
  10. Save the OAMAuthentication configuration.

If Mobile and Social is configured to work with a remote instance of the Oracle Access Manager 10g server, you must also do either of the following:

- Define a `uid` attribute in the directory DN entry for user records in the Oracle Access Manager `UserStore`.
- Define a unique directory user entry attribute that can be used to identify the directory user entry in Mobile and Social.

---



---

**Note:**

Mobile and Social can dynamically obtain the unique directory user attribute name from Oracle Access Manager version 11g but the earlier 10g release requires that you specify the attribute to use when configuring Mobile and Social. If this attribute is not set, Client Token validation will fail in Mobile and Social.

---



---

The following procedure demonstrates setting the value to `CN`. Set the value to a unique user entry as configured on your directory server; `uid` or `loginid` may also be possible choices. Before beginning, confirm that the Oracle Access Manager DN for `UserStore` does not include a `uid` attribute for the Application Profile `profileid1`, and that the DN is as follows:

```
"CN=profileid1 profileid1, OU=Test, ..."
```

Complete the next steps upon confirming that both are true.

1. Open the Application Profile Configuration page for `profileid1` in Mobile and Social.

See [Defining Application Profiles](#).

2. In the Attributes section, add the following name-value pair and click Apply.

**Name:** `userPrincipalAttrValue`

**Value:** CN

3. Open the Service Provider Configuration page for your Oracle Access Manager 10g Authentication Service Provider.

See [Defining, Modifying or Deleting an Authentication Service Provider](#).

4. In the Attributes section, add the following name-value pair and click Apply.

**Name:** userPrincipalAttrName

**Value:** CN

### 49.9.1.3 Configuring an Authentication Service Provider for Remote Access Manager 11gR2 or Oracle Access Manager 11gR1 PS1

You can configure an Authentication Service Provider to work with releases 11gR2 and 11gR1 PS1.

The differences for the 11gR1 PS1 release console are documented in notes in each 11gR2 step.

---



---

**Note:**

See [Deployment Constraints for Mobile and Social](#) for information about deploying Mobile and Social with a Webgate.

---



---

To configure an authentication service provider for Remote Access Manager 11gR2 or Oracle Access Manager 11gR1 PS1:

1. Log into the Oracle Access Management Console and register a Webgate (OAM Agent) for Mobile and Social.

Be sure to enable the following options.

- Allow Management Operations
- Allow Token Scope Operations
- Allow Master Token Retrieval
- Allow Credential Collector Operations

---



---

**Note:**

If using an OAM 11.1.1.*n* release console, enable **Allow Management Operations**.

---



---

2. Navigate through the Mobile and Social Console to **Mobile and Social Services > Service Providers > Authentication Service Providers**.
3. Click **New** to create a new Authentication Service Provider configuration.
4. When using an OAM 11.1.2 release console, enter the following values:
  - a. Keep the default value of OAM\_VERSION as OAM\_11G.

- b. Change `WEBGATE_ID` to the name you previously used to create the WG profile.
- c. Change `OAM_SERVER_1` to the *hostname:port#* of the machine hosting the OAM 11G server.

---

**Note:**

If using an OAM 11.1.1.*n* release console:

- a. Change the default value of `OAM_VERSION` to `OAM_10G`.
  - b. Change `WEBGATE_ID` to the name you previously used to create the WG profile.
  - c. Change `OAM_SERVER_1` to the *hostname:port#* of the machine hosting the OAM 11.1.1.5 server.
  - d. Add a new parameter named `AuthURL` and populate it with the URL for any protected resource; for example, `http://server1.example.com/index.html`.
- 

- 5. Save the Authentication Service Provider configuration.
- 6. Navigate through the Mobile and Social Console to **Mobile and Social Services > Service Profiles > Authentication Services > OAMAuthentication**.
- 7. From the Service Provider drop-down menu, select the Authentication Service Provider just created; for example, `10GOAMAuthentication`.
- 8. Select the **Client Token** checkbox.
- 9. Clear the **Access Token** checkbox only if using OAM 11g R1 PS1.
- 10. Save the OAMAuthentication configuration.
- 11. Merge the CSF wallet files.

OAM 11G generates the `cwallet.sso` file when the administrator creates the WG profile for Mobile and Social. To communicate with this WG profile, the administrator must merge the secret value in `cwallet.sso` into the Mobile and Social wallet.

---

**Note:**

Use the following command to display the wallet before and after the merge for verification that the merge has been successful.

```
orapki wallet display -wallet wallet_location
```

---

- a. Copy `cwallet.sso` from OAM (`~/domain-home/output`) to the Mobile and Social host machine directory, `/tmp/oam`.
- b. Copy `cwallet.sso` from the Mobile and Social host machine directory (`~/config/fmwconfig`) to the Mobile and Social host machine directory, `/tmp/oic`.

- c. Download `merge-creds.xml` to the Mobile and Social host machine directory, `/tmp`.

The following is a sample `merge-creds.xml` file.

#### Sample `merge-creds.xml`

```
<?xml version="1.0" encoding="UTF-8" standalone="yes"?>
<jpsConfig xmlns="http://xmlns.oracle.com/oracleas/schema/11/jps-
config-11_1.xsd"
 xmlns:xsi="http://www.w3.org/2001/XMLSchema-instance"
 xsi:schemaLocation=
 "http://xmlns.oracle.com/oracleas/schema/11/jps-config-11_1.xsd"
 schema-major-version="11" schema-minor-version="1">

<serviceProviders>
<serviceProvider

class="oracle.security.jps.internal.credstore.ssp.SspCredentialStoreProvider
"
 name="credstoressp" type="CREDENTIAL_STORE">
<description>File-based credential provider</description>
</serviceProvider>
</serviceProviders>

<serviceInstances>
<!-- Source file-based credential store instance -->
<serviceInstance location="/tmp/oam" provider="credstoressp"
 name="credential.file.source">
</serviceInstance>

<!-- Destination file-based credential store instance -->
<serviceInstance location="/tmp/oic" provider="credstoressp"
 name="credential.file.destination">
</serviceInstance>
</serviceInstances>

<jpsContexts>
<jpsContext name="FileSourceContext">
<serviceInstanceRef ref="credential.file.source"/>
</jpsContext>

<jpsContext name="FileDestinationContext">
<serviceInstanceRef ref="credential.file.destination"/>
</jpsContext>
</jpsContexts>
</jpsConfig>
```

- d. Set the `PATH` variable to include `~/oracle_common/bin:~/oracle_common/common/bin:~`
- e. Initialize the WebLogic Scripting Tool by running `wlst.sh` on the command line.
- f. Run the `migrateSecurityStore WLST` command.

Following is sample syntax for the WLST command.

```
$ wlst.sh
```

```
wls:/offline> connect("weblogic", "weblogic-passwd", "localhost:<port>")
```

```
wls:/WLS_IDM/serverConfig>
migrateSecurityStore(type="credStore",configFile="/tmp/merge-creds.xml",
src="FileSourceContext",dst="FileDestinationContext")
```

12. Restart the Mobile and Social server.

## 49.9.2 Configuring Mobile and Social Services for Oracle Adaptive Access Manager

You can configure a Service Domain to use the Oracle Adaptive Access Manager (OAAM) device registration functionality.

To configure a Service Domain, open the Service Domain Configuration page and choose the **OAAMSecurityHandlerPlugin** option from the **Security Handler Plugin Name** list.

See [Creating a Service Domain](#).

---

---

**Note:**

During installation, the Oracle Fusion Middleware Configuration Wizard can generate a domain that supports both Mobile and Social and Oracle Adaptive Access Manager. Mobile and Social requires at least Oracle Adaptive Access Manager version 11g Release 2. For more information, see the "Configuring Mobile and Social" chapter in the *Oracle Fusion Middleware Installation Guide for Oracle Identity and Access Management*.

---

---

The following topics describe how to configure the required policies, conditions, rules, and actions to complete integration between Mobile and Social and OAAM:

- [OAAM Support in Mobile and Social](#)
- [Configuring the WebLogic Administration Domain](#)
- [Configuring OAAM if Social Identity Authentication is Enabled in Mobile and Social Services](#)
- [Setting up a Lost or Stolen Device Rule](#)
- [Configuring Blacklisted Devices and Applications](#)
- [About OAAM Sessions for Mobile Applications](#)
- [Registering Users for OAAM Authentication](#)
- [Setting up OAAM Knowledge-Based Authentication](#)
- [Setting up OAAM One Time Password](#)

### 49.9.2.1 OAAM Support in Mobile and Social

Here is a list of OAAM policies supported by Mobile and Social.

[Table 49-21](#) displays the supported OAAM policies (by OAAM checkpoint).



**Table 49-21 OAAM Policies Supported By Mobile and Social**

Checkpoint	Supported Policies
Post-Authentication	OAAM Post-Authentication Security OAAM User vs Themselves OAAM User vs. All Users OAAM Does User Have Profile OAAM Predictive Analysis Policy
Challenge	OAAM Challenge Policy
Device Identification	OAAM Device ID Policy OAAM System Deep Analysis Flash Policy OAAM System Deep Analysis No Flash Policy

Mobile and Social and OAAM also use similar terminology to describe the security actions that can be taken to respond to authentication and authorization events.

[Table 49-22](#) maps the Mobile and Social term to the OAAM term.

**Table 49-22 Mapping Terms Between OAAM and Mobile and Social**

OAAM Action Groups	Mobile and Social Actions
OAAM Allow	ALLOW
OAAM Block	DENIED
OAAM Challenge	CHALLENGE
OAAM Black-Listed Mobile Device	WIPE_OUT
OAAM Lost Device	WIPE_OUT

Use the Oracle Adaptive Access Manager Administrator's Console to customize OAAM policies and rules.

### 49.9.2.2 Configuring the WebLogic Administration Domain

Before you start to configure any OAAM policies, you need to complete the the following tasks:

- [Creating an Administrator for OAAM Administration](#)
- [Adding Oracle Access Management Server as Target of OAAM Data Source](#)

#### 49.9.2.2.1 Creating an Administrator for OAAM Administration

You can create an Administrator for OAAM administration from the Oracle WebLogic Administration Console.

To create:

1. Log into the Oracle WebLogic Administration Console for your WebLogic administration domain.

2. In the **Domain Structure** tab on the left side of the page, select **Security Realms**.
3. On the **Summary of Security Realms** page, select the realm that you are configuring; for example, *myrealm*.
4. Click **New** and provide the required information to create a User in the security realm: Name (for example, *user1*), Description (optional), Provider (enter DefaultAuthenticator), Password, and Confirm Password.
5. Click to select the new created User.
6. Click the **Groups** tab.
7. Assign to the User all groups with an OAAM prefix.
8. Click **Save**.

#### 49.9.2.2 Adding Oracle Access Management Server as Target of OAAM Data Source

You can add Oracle Access Management Server as a target of OAAM data source.

To add:

1. Log in to the Oracle WebLogic Administration Console for your WebLogic administration domain.
2. In the **Domain Structure** tab on the left side of the page, select **Services**.
3. On the **Summary of Services** page, select Data Sources.
4. Open OAAM\_SERVER\_DS in the Data Sources table.
5. Click the **Targets** tab.
6. Select *oam\_server1*.
7. Click **Save**.

#### 49.9.2.3 Configuring OAAM if Social Identity Authentication is Enabled in Mobile and Social Services

If Mobile and Social Services is configured to accept an authentication result from Social Identity, you can configure OAAM to work with Mobile and Social when users authenticate.

To configure OAAM if Social Identity Authentication is enabled in Mobile and Social Services:

1. Log into the OAAM Administration Console.
2. Click Policies and search for the OAAM Mobile and Social Integration Post-Authentication Security policy.
3. In the policy find the following rule: **Mobile device is not registered**.
4. Add a condition:
  - a. Search on "Session: Check value in comma separated values."
  - b. Add the following:  
Parameter Key : oic.userIdType

Value to Check : URI

Return if in list : false

#### 49.9.2.4 Setting up a Lost or Stolen Device Rule

You can set up a Lost or Stolen Device Rule for each device reported as missing by adding the Device ID to the *OAAM Lost or Stolen Devices* device group.

Users should report lost or stolen devices to the support department so that the missing device can be added to the OAAM Lost or Stolen Device group. Then if an authentication attempt comes from the missing device, OAAM can send Mobile and Social a DENY or WIPE\_OUT action to wipe out the application's data associated with the Mobile and Social server. If a User recovers a missing device, the device status can be reset in OAAM.

To set up a Lost or Stolen Device Rule:

1. Log into the OAAM Administration Console.
2. Double-click **Sessions** in the Navigation pane.  
The Sessions Search page displays.
3. Search by **User Name**, **Client Application** name, **Device ID** or similar to find the lost or stolen device.
4. Click the Session ID in the **Search Results** table.  
The Session Details page opens.
5. Click **Add to Group**.  
The Add to Group pop-up window opens.
6. In the **Choose Data Type to Add** section, choose **Device** and click **Next**.
7. Select the **OAAM Lost or Stolen Devices** Group and click **Next**.
8. Verify your selection and click **Finish**.
9. Click **OK**.

#### 49.9.2.5 Configuring Blacklisted Devices and Applications

Rules can be configured to block access to specific devices or applications.

The following topics include additional information:

- [Setting up a Blacklisted Device Rule](#)
- [Setting up a Blacklisted Application Rule](#)

##### 49.9.2.5.1 Setting up a Blacklisted Device Rule

You can create a Blacklisted Device Rule for each device to which you want to block access.

To set up a Blacklisted Device Rule by adding the Device ID to the *OAAM Black-listed Mobile Devices* group:

1. Log in to the OAAM Administration Console.

2. Double-click **Sessions** in the Navigation pane.  
The Sessions Search page displays.
3. Use the Search page to find the device to block. For example, search by a **User Name**, a **Client Application** name, a **Device ID**, and so on.
4. Click the Session ID in the **Search Results** table.  
The Session Details page opens.
5. Click **Add to Group**.  
The Add to Group pop-up window opens.
6. In the **Choose Data Type to Add** section, choose **Device** and click **Next**.
7. Select the **OAAM Black-listed mobile devices** Group and click **Next**.
8. Verify your selection and click **Finish**.
9. Click **OK**.

#### 49.9.2.5.2 Setting up a Blacklisted Application Rule

The task of adding a Blacklisted Application Rule is broken into the following tasks sequentially.

To add the application to the *OAAM Blacklisted Mobile Devices* group:

- [Creating a New Alert Group](#)
- [Creating a Generic Strings Group to Store Blacklisted Application Names](#)
- [Creating a New Blacklisted Application Rule](#)

##### 49.9.2.5.2.1 Creating a New Alert Group

You can create a new alert group from the OAAM Administration Console.

To create:

1. Log in to the OAAM Administration Console.
2. Double-click **Groups** in the Navigation pane.  
The Groups Search page displays.
3. Click **New Group**.  
The Create Group pop-up window opens.
4. Complete the form as follows and click **Create**:
  - **Group Name** - Type OAAM Blacklisted mobile application used. (This is the name of the mobile application to be blacklisted.)
  - **Group Type** - Choose **Alerts** from the menu.
  - **Cache Policy** - Choose **Full Cache** from the menu.
  - **Description** - Type Session coming from a blacklisted mobile application.

5. Click the **Alerts** tab.
6. Click the **Add member to this group** button.  
The Add Alerts pop-up window opens.
7. In the **Options to add a new element** section, choose **Create new Alerts**.

Complete the form as follows and click **Add**:

- **Alert Type** - Choose **Fraud** from the menu.
- **Alert Level** - Choose **Medium** from the menu.
- **Alert Message** - Type `Session coming from a blacklisted mobile application`.

The **Add Alerts** window displays a message confirming that the new element was created successfully.

#### 49.9.2.5.2.2 *Creating a Generic Strings Group to Store Blacklisted Application Names*

You can create a generic strings group to store blacklisted application names.

To create:

1. Double-click **Groups** in the Navigation pane.  
The Groups Search page displays.
2. Click **New Group**.  
The Create Group pop-up window opens.
3. Complete the form as follows and click **Create**:
  - **Group Name** - Type `OAAM blacklisted mobile application`.
  - **Group Type** - Choose **Generic Strings** from the menu.
  - **Cache Policy** - Choose **Full Cache** from the menu.
  - **Description** - Type `OAAM blacklisted mobile application`.
4. Click the **Generic Strings** tab, then click the **Add member to this group** button.
5. Type the name of the app.

The **Add Generic Strings** window displays a message confirming that the new element was created successfully.

Click OK.

#### 49.9.2.5.2.3 *Creating a New Blacklisted Application Rule*

You can add a new rule for a blacklisted mobile application.

To create a rule:

1. Double-click **Policies** in the Navigation pane.  
The Policies Search page displays.
2. Choose **Post authentication** from the **Checkpoint** menu, then click **Search**.

3. Click **OAAM Post-Authentication Security**.  
The OAAM Post-Authentication Security page opens.
4. Click the **Rules** tab.
5. Click the Add Rule button.  
Complete the form as follows and click **Add**:
  - **Rule Name** - Type `Check for blacklisted mobile applications`.
  - **Rule Status** - Choose **Active** from the menu.
  - **Rule Notes** - Type `Check if application is in the Oaam blacklisted mobile application group`.
6. Click the **Conditions** tab.
7. Click **Add Conditions**.  
The Add Condition pop-up window opens.
8. Complete the form as follows and click **Search**:
  - **Condition Name** - Type `Check Current Session`
  - **Type** - Choose **In Session** from the menu.
9. In the table of results, click **Session: Check Current Session using the filter conditions**.  
The filter condition details display.
10. Do the following and click **Save**:
  - a. Under **Check if** select **Client Application**.
  - b. Select **in** as the operator.
  - c. Select **Group** as the Target Type.
  - d. Select **Generic Strings** as the Group Type.
  - e. Select **OAAM blacklisted mobile application** as the Group Name.

In English the condition reads as "Check if the Client Application is in the "OAAM blacklisted mobile application" group."
11. Click the **Results** tab.
12. Choose **OAAM Block** from the **Action Group** menu.
13. Choose **OAAM Blacklisted application used** from the **Alert Group** menu.
14. Click **Apply**.

#### 49.9.2.6 About OAAM Sessions for Mobile Applications

The OAAM Session is a commonly used conceptual entity in OAAM rule execution.

A rule can use a session attribute as input (for example, Client App Name and OAAM Device ID) and affect the status of the session at the output (that is, changing the status

to "Blocked"). When OAAM is used in a non-mobile environment such as a web browser, there is a one-to-one relationship between a user authentication session (an OAM session, for example) and the OAAM session. For example, each OAAM session contains data associated with the following fields:

- User ID
- Client IP Address
- OAAM Device ID and Fingerprint
- (Auth) Status: Success, Pending, Blocked, and so on
- Client Application Name

In a mobile application environment, different apps running on the same device used by the same user are expected to have different OAAM sessions, even in a mobile SSO scenario. For example, assume the following apps are installed on a mobile device:

- SSO Security Agent App
- White Pages App
- Expense Report App

These apps are listed together as participants of the same Service Domain and they all participate in single sign-on. A user just needs to log in once using the mobile SSO agent app. This means that there will only be a single User Authentication session (that is, a single Access Manager session) shared by multiple apps on the same device. On the other hand, if the user uses all three apps simultaneously within the same Access Manager session, each mobile application will have its own OAAM session entry and three OAAM sessions will be seen in the OAAM Admin Console.

The reason to have separate OAAM sessions for each mobile application is to allow rules to take the mobile client application into account. The same rule can block sessions from some apps, while letting sessions from other apps succeed. (The Blacklisted Application Rule in [Setting up a Blacklisted Application Rule](#) is an example of this.) A more sophisticated rule can consider multiple factors from a session; for example an Expense Report application might rate as security sensitive while a "White Pages" (directory look-up) application might rate as less sensitive. The same Risky-IP rule may block sessions from the Expense Report application but not the White Pages app, even if the sessions come from the same medium-risky IP address.

#### 49.9.2.7 Registering Users for OAAM Authentication

OAAM provides strong authentication features, such as Knowledge-Based Authentication and One-Time Password.

One-Time Password delivers a password using e-mail or a mobile text message. These features require end users to register a security profile that may contain security questions, mobile phone numbers, and e-mail addresses.

The following topics include information on setting up these authentication processes:

- [Setting up OAAM Knowledge-Based Authentication](#)
- [Setting up OAAM One Time Password](#)

#### 49.9.2.7.1 Setting up OAAM Knowledge-Based Authentication

Mobile and Social provides support for Knowledge-Based Authentication (KBA) if OAAM is installed.

KBA is the default option for Strong Authentication in OAAM. Administrators do not need to perform extra configuration for KBA to work. Users should use the OAAM Managed Server Console to record their KBA questions in their User Profile registration.

#### 49.9.2.7.2 Setting up OAAM One Time Password

Mobile and Social provides One Time Password (OTP) support if OAAM is installed.

OTP allows end users to authenticate themselves by entering a server generated one-time-password that might be received by either SMS or e-mail. Because the one-time-password is sent out-of-band, the risk is reduced that someone other than the valid user could obtain access to it.

The following topics include additional information:

- [Setting Up OTP E-Mail Integration](#)
- [Setting Up OTP Integration for SMS Messages](#)
- [Changing the OAAM Challenge Policy Trigger Combination](#)

##### 49.9.2.7.2.1 Setting Up OTP E-Mail Integration

You can configure either SMTP or UMS so that Mobile and Social can send the e-mail.

Mobile and Social can send e-mail in either of the following ways.

- Using the included SMTP client.
- Using the Oracle User Messaging Service (UMS).

This topics includes a procedure for each of these integrations. Choose either Setting Up SMTP for E-mail or Setting Up UMS for E-mail to begin.

---

---

**Note:**

*Configure either SMTP or UMS. Do not configure both.*

---

---

After configuring the SMTP or UMS attribute values, enable the Challenge Types on the OAAM server as documented in this section's third procedure, Enable "Challenge Types" on the OAAM Server for E-mail.

Setting Up SMTP for E-mail

1. Access the Mobile and Social Services configuration page.  
See [Opening the Mobile and Social Services Configuration Page](#).
2. In the **Security Handler Plugins** section on the right side of the screen, click **OaamSecurityHandlerPlugin** and click **Edit** in the tool bar.
3. In the **Attributes** section provide values for the following attribute names and click **Apply**.  
**mail.smtp.host** - The SMTP server host.



- mail.smtp.port** - The SMTP server port.
- mail.smtp.security.type** - The SMTP security type. Either SSL or TLS.
- mail.smtp.user** - The user name to log on to the SMTP server.
- mail.smtp.fromadd** - The Mobile and Social "From" address, for example:  
*mobileadmin@example.com*
- mail.smtp.password** - The password for the `mail.smtp.user` account.
- mail.smtp.truststore.location** - The file name with the location of the trust store to be used to validate the server identity.
- mail.smtp.keystore.location** - The file name of the key store containing the client certificate.
- mail.smtp.keystore.password** - The key store password.
- mail.smtp.truststore.password** - The trust store password.
4. Complete the steps in Enable "Challenge Types" on the OAAM Server for E-mail.  
Setting Up UMS for E-mail
    1. Access the Mobile and Social Services configuration page.  
See [Opening the Mobile and Social Services Configuration Page](#).
    2. In the **Security Handler Plugins** section on the right side of the screen, click **OaamSecurityHandlerPlugin** and click **Edit** in the tool bar.
    3. In the **Attributes** section provide values for the following attribute names and click **Apply**.
 

**ums.service.uri** - The UMS server Web service URL, for example:  
`http://<UMS Server URL>:<UMS Port>/ucs/messaging/webservice`

**ums.username** - The user name for the UMS server.

**ums.password** - The password for the UMS server.

**ums.from.address** - The Mobile and Social "From" address, for example:  
*mobileadmin@example.com*

**ums.from.name** - The Mobile and Social "From" name.

**ums.email.enabled** - Set to `true`.
  4. Complete the steps in Enable "Challenge Types" on the OAAM Server for E-mail.  
Enable "Challenge Types" on the OAAM Server for E-mail
    1. Log into the OAAM Administration Console.
    2. Choose **Environment > Properties** in the Navigation pane and double-click **Properties**.  
The Properties Search page displays.
    3. In the **Search** box, type `bharosa.uio.default.register.userinfo.enabled` in the **Name** field and click **Search**.  
Click to select the record in the **Search Results** section, change the value to `true`, and click **Save**.

4. In the **Search** box, type `bharosa.uio.default.userinfo.inputs.enum.email.enabled` in the **Name** field and click **Search**.

Click to select the record in the **Search Results** section, change the value to `true`, and click **Save**.

5. In the **Search** box, type `bharosa.uio.default.challenge.type.enum.ChallengeEmail.available` in the **Name** field and click **Search**.

Click to select the record in the **Search Results** section, change the value to `true`, and click **Save**.

#### 49.9.2.7.2.2 Setting Up OTP Integration for SMS Messages

Mobile and Social sends SMS messages using the Oracle UMS.

Complete Setting Up SMS Using UMS and then Enable "Challenge Types" on the OAAM Server for SMS.

#### Setting Up SMS Using UMS

1. Access the Mobile and Social Services configuration page.  
See [Opening the Mobile and Social Services Configuration Page](#).
2. In the **Security Handler Plugins** section on the right side of the screen, click **OaamSecurityHandlerPlugin** and click **Edit** in the tool bar.
3. In the **Attributes** section provide values for the following attribute names and click **Apply**.

**ums.service.uri** - The UMS server Web service URL, for example:

`http://<UMS Server URL>:<UMS Port>/ucs/messaging/webservice`

**ums.username** - The user name for the UMS server.

**ums.password** - The password for the UMS server.

**ums.from.address** - The Mobile and Social "From" address, for example:  
`mobileadmin@example.com`

**ums.from.name** - The Mobile and Social "From" name.

**ums.email.enabled** - Set to `true`.

4. Complete the steps in the Enable "Challenge Types" on the OAAM Server for SMS.

#### Enable "Challenge Types" on the OAAM Server for SMS

1. Log into the OAAM Administration Console.
2. Choose **Environment > Properties** in the Navigation pane and double-click **Properties**.

The Properties Search page displays.

3. In the **Search** box, type `bharosa.uio.default.register.userinfo.enabled` in the **Name** field and click **Search**.

Click to select the record in the **Search Results** section, change the value to `true`, and click **Save**.

4. In the **Search** box, type `bharosa.uio.default.challenge.type.enum.ChallengeSMS.available` in the **Name** field and click **Search**.

Click to select the record in the **Search Results** section, change the value to `true`, and click **Save**.

#### 49.9.2.7.2.3 *Changing the OAAM Challenge Policy Trigger Combination*

OAAM evaluates the Challenge policy when an event triggers the Challenge action. You can change the OAAM Challenge Policy Trigger Combination from the OAAM Administration Console.

If KBA is active for a User, the system challenges the User with questions from the OAAM Challenge Question Action Group. If the User fails the OAAM challenge questions three times, the system starts the OAAM SMS Challenge Action group.

You can reorder the Action Group using OAAM Challenge Policy trigger combinations. So other Challenge Action Groups, such as the OAAM Challenge E-Mail group or the OAAM Challenge SMS group, will take precedence over the OAAM Challenge question.

To change the OAAM Challenge Policy Trigger Combination:

1. Log in to the OAAM Administration Console.
2. Double-click **Policies** in the Navigation pane.  
The Policies Search page displays.
3. Choose **Challenge** from the **Checkpoint** menu, then click **Search**.
4. Click to select **OAAM Challenge Policy** in the **Search Results** table.
5. Click the **Trigger Combinations** tab.
6. Click **Reorder**.

The **Reorder Trigger Combinations** pop-up window opens.

7. Use the controls to move trigger combinations to higher or lower positions.



---

## Configuring Social Identity

Mobile and Social provides a graphical user interface for configuring Social Identity. (Prior to version 11.1.2.2, Social Identity was named Internet Identity Services.)

This chapter describes how to use the Oracle Access Management Console to configure Mobile and Social Services and contains the following topics.

- [Opening the Manage Social Identity Page](#)
- [Understanding Social Identity Configuration](#)
- [Defining Social Identity Providers](#)
- [Defining Service Provider Interfaces](#)
- [Defining Application Profiles](#)
- [Integrating Social Identity With Mobile Applications](#)
- [Linking Social Identity Provider Accounts](#)

---

**Note:**

Social Identity can also be configured from the command line using WLST.

See Mobile and Social Commands in *WebLogic Scripting Tool Command Reference for Identity and Access Management*.

---

---

**WARNING:**

Only use tools provided with OAM Mobile and Social to change passwords, security credentials, or keys. Specifically, do not use Oracle Enterprise Manager (EM) for this purpose, because it is not compatible with the Mobile and Social credential store.

---

### 50.1 Opening the Manage Social Identity Page

You can open the Manage Social Identity page in the Oracle Access Management Console.

To open:

1. In to the Oracle Access Management Console, click **Federation** at the top of the window.
2. Click **Social Identity**.

3. Click an OAuth Identity Domain to configure it.

## 50.2 Understanding Social Identity Configuration

The *Welcome to Mobile and Social - Social Identity* configuration page is divided into separate panels that can be expanded and collapsed by clicking the arrow button in the top left corner of the panel.

The following sections contain more information about the Social Identity panels.

- [Social Identity Providers](#)
- [Service Provider Interfaces](#)
- [Application Profiles](#)

### 50.2.1 Social Identity Providers

The Social Identity Providers panel is used to edit the (preconfigured) configuration details for Identity Providers such as Google, Facebook, Twitter, and the like. Once established, you should not need to modify these settings very often.

You can also define configuration details for Social Identity Providers that you add yourself by implementing the `oracle.security.iamas.rp.spi.IdentityProvider` Java interface. For information about adding additional Social Identity Providers, see "Extending the Capabilities of the Mobile and Social Server" in the *Oracle Fusion Middleware Developer's Guide for Oracle Access Management*.

More information on Social Identity Providers is in

See [Defining Social Identity Providers](#) .

### 50.2.2 Service Provider Interfaces

The Service Provider Interface refers to the set of rules that govern the authentication flow for the specified Application Profile.

Mobile and Social provides the following Service Provider Interfaces:

- **DefaultServiceProviderInterface** - provides support for web applications that run on Java-compliant application servers.
- **OAMServiceProviderInterface** - provides support for web applications that run on the Access Manager service.

More information on Service Provider Interfaces is in [Defining Service Provider Interfaces](#).

---

---

**Note:**

A Java developer can write custom implementations of one or more of the Identity Provider interface contracts. Use the **Service Provider Interfaces** section only if you need to add a custom Service Provider created by a developer.

---

---

### 50.2.3 Application Profiles

An Application Profile defines an application that uses Social Identity Provider services on the Mobile and Social server.

You can use this panel to configure mobile applications, web applications that run on Java-compliant application servers, and web applications that are integrated with Access Manager to use Social Identity.

- If a web application is not integrated with Access Manager, integrate the Social Identity login page with the web application. See the "Developing Applications Using the Social Identity Client SDK" chapter in the *Oracle Fusion Middleware Developer's Guide for Oracle Access Management* for details.
- If the web application is integrated with Access Manager, edit the preconfigured Application Profile named OAMApplication. When Access Manager and Mobile and Social are installed together during Oracle Access Management installation, both products are registered as trusted partners and the preconfigured Application Profile is included. As a result, you do not need to write code to integrate web applications that are integrated with Access Manager and Social Identity. The *OAMApplication* Application Profile that is included with Mobile and Social is preconfigured to work with Access Manager and requires only minor configuration changes to get working in your environment.

More information on Application Profiles is in [Defining Application Profiles](#).

## 50.3 Defining Social Identity Providers

The Social Identity Provider collects configuration details for Identity Providers such as Google, Facebook, Twitter, and the like.

Once created, you should not need to modify Social Identity Provider settings very often. The following sections provide information regarding creating, modifying and deleting Social Identity Providers.

- [Creating a Social Identity Provider](#)
- [Editing or Deleting a Social Identity Provider](#)
- [Generating the Consumer Key and Consumer Secret for OAuth Providers](#)
- [Troubleshooting Facebook Social Identity Providers](#)

### 50.3.1 Creating a Social Identity Provider

Social Identity Providers can also be created using the WebLogic Scripting Tool.

See Mobile and Social Commands in *WebLogic Scripting Tool Command Reference for Identity and Access Management*.

1. Access the Manage Social Identity page as described in [Opening the Manage Social Identity Page](#).
2. Click **Create** in the **Social Identity Provider** panel in the home area.

The Create New Social Identity Provider configuration page displays.

3. Enter values for the Social Identity Provider properties.

- **Name** - Type a unique name for this Authentication Service Provider.
- **Description** - (Optional) Type a short description that will help you or another Administrator identify this service in the future.
- **Social Identity Provider Protocol** - Select the Identity Provider Protocol from the drop down menu.
  - OpenID
  - OAuth
  - Custom

Select **Custom** to configure a custom Identity Provider. Your choice here will change the displayed Protocol Attributes and User Attributes Returned panels to reflect properties more specific to the authentication protocol being used by the Social Identity Provider - either OpenID or OAuth.

- **Implementation Class** - Based on the Social Identity Provider Protocol selection, the appropriate provider-specific implementation of the `oracle.security.idaas.rp.spi.IdentityProvider` Java interface will be populated in this field. (If Custom, enter the corresponding implementation class that should interact with the Identity Provider.) The Mobile and Social server will use this information to communicate with this Social Identity Provider.
4. Enter values for the Protocol Attributes properties based on the protocol being used by the Social Identity Provider previously selected: OpenID (Table 50-1) or OAuth (Table 50-2). (If Custom, add all values required by the custom Provider and related to the authentication protocol used.)
- Provide values required by the Identity Provider implementing the OpenID protocol as specified in Table 50-1.

**Table 50-1 OpenID Protocol Attributes**

Name	Values	Notes
Yadis Endpoint	Must be an absolute HTTP or HTTPS URL	Type the published URL that accepts OpenID authentication protocol messages for this Identity Provider. Mobile and Social uses this URL to make user authentication requests.
Hashing Algorithm	<ul style="list-style-type: none"> <li>- SHA256 is a 256-bit key length algorithm</li> <li>- SHA1 is a 160-bit key length algorithm</li> <li>- None</li> </ul>	Choose a signature algorithm. Mobile and Social uses this value internally to configure the Session Type and Association Type properties for communicating with the Identity Provider.



**Table 50-1 (Cont.) OpenID Protocol Attributes**

Name	Values	Notes
Authentication Policy	Choose Yes to request that an authentication policy be applied by the OpenID Provider when authenticating a user. Otherwise, choose No.	Usage of PAPE (Provider Authentication Policy Extension) allows web developers to request other modifications to the flow, such as asking that the Identity Provider re-prompt the User for their password.
Authentication Policy Maximum Age	Provide a value greater than or equal to zero seconds. Specify 0 to force a password re-prompt.	Type the maximum length of time in seconds that a User who has not <i>actively</i> authenticated can use a login session before being required to authenticate using the requested authentication policy. Use this parameter to ensure that the login session of the user at the Identity Provider is recent.
Preferred Authentication Policies		Type zero or more URIs separated by a space that represent authentication policies that the Identity Provider must satisfy when authenticating the user. For example:  <code>http://schemas.openid.net/pape/policies/2007/06/phishing-resistant</code>  <code>http://schemas.openid.net/pape/policies/2007/06/multi-factor</code>

- Provide values required by the Identity Provider implementing the OAuth protocol as specified in [Table 50-2](#).

**Table 50-2 OAuth Protocol Attributes**

Name	Value	Notes
Authorization URL	The Identity Provider's published OAuth authorization URL. If an Identity Provider changes a published OAuth URL, update this value to match.	Mobile and Social directs the User to this URL after the Identity Provider returns the request token (see <i>Request Token URL</i> ). The Identity Provider verifies the User's identity, and the User grants the Identity Provider permission to release the User's protected information to the Mobile and Social server.
Access Token URL	Type the Identity Provider's published access token URL.	Mobile and Social uses this URL to request an access token from the Identity Provider after the User authorizes the request token (using the <i>Authorization URL</i> ).

**Table 50-2 (Cont.) OAuth Protocol Attributes**

Name	Value	Notes
Request Token URL	Type the Identity Provider's published Request Token URL. (Not applicable to Facebook.)	Mobile and Social uses this URL to obtain a request token from the Identity Provider. After the Identity Provider grants the request token, the Mobile and Social server directs the User to the Identity Provider's <i>Authorization URL</i> . (The term <i>temporary credentials</i> supplants the terms <i>request token</i> and <i>request secret</i> in RFC 5849, <i>The OAuth 1.0 Protocol</i> .)
Profile URL	Type the Identity Provider's published Profile URL.	Mobile and Social uses this URL to request User attributes based on a OAuth access token.
Consumer Key	Type the value that the Mobile and Social server should use to identify itself to the Identity Provider.	See <a href="#">Generating the Consumer Key and Consumer Secret for OAuth Providers</a> for information about requesting a Consumer Key from the Identity Provider.
Consumer Secret	Type the secret that the Mobile and Social server should use to establish ownership of the Consumer Key.	See <a href="#">Generating the Consumer Key and Consumer Secret for OAuth Providers</a> for information about requesting a Consumer Secret from the Identity Provider.
Server Time Sync	If the Mobile and Social server and a remote Identity Provider are not time synchronized, type the number of minutes of skew to add to the current server time when sending requests to the remote Provider. This field accepts both positive and negative integers.	Typically LinkedIn requires synchronized server time values. Not applicable for Facebook or Twitter.  In the <b>Attribute Name</b> column type the local application attribute name that should be assigned to the attribute name returned by the OpenID Identity Provider. In the <b>Attribute Schema Name</b> column, type the URL where the Mobile and Social server can request user data from the Identity Provider.  If you add attributes in the Attribute Name column that the Identity Provider does not support, those attributes will not be available in Mobile and Social.

5. Add values to the User Attributes Returned panel based on the Social Identity Provider Protocol previously selected: OpenID, OAuth or Custom.

- **OpenID:** In the **Attribute Name** column type the local application attribute name that should be assigned to the attribute name returned by the Identity Provider. In the **Attribute Schema Name** column, type the URL where the Mobile and Social server can request user data from the Identity Provider. If you add attributes in the Attribute Name column that the Identity Provider does not support, those attributes will not be available in Mobile and Social. [Table 50-3](#) and [Table 50-4](#) lists the user attributes supported by Google and Yahoo.

**Table 50-3 User Attributes Returned By Google**

Attribute	Description
country	Requests the user's home country. Must be set to: <code>http://axschema.org/contact/country/home</code>
email	Requests the user's Gmail address. Must be set to: <code>http://axschema.org/contact/email</code>
firstname	Requests the user's first name. Must be set to: <code>http://axschema.org/namePerson/first</code>
language	Requests the user's preferred language. Must be set to: <code>http://axschema.org/pref/language</code>
lastname	Requests the user's last name. Must be set to: <code>http://axschema.org/namePerson/last</code>

**Table 50-4 User Attributes Returned By Yahoo**

Attribute	Description
gender	Requests the user's gender. Must be set to: <code>http://axschema.org/person/gender</code>
email	Requests the user's e-mail address. Must be set to: <code>http://axschema.org/contact/email</code>
fullname	Requests the user's full name. Must be set to: <code>http://axschema.org/namePerson</code>
language	Requests the user's preferred language. Must be set to: <code>http://axschema.org/pref/language</code>
nickname	Requests the user's preferred name. Must be set to: <code>http://axschema.org/namePerson/friendly</code>
Timezone	Requests the user's preferred time zone. Must be set to: <code>http://axschema.org/pref/timezone</code>

- **OAuth:** Specify the User Attributes that the OAuth Identity Provider should return. In the **Attribute Name** column type the local application attribute name that corresponds to the attribute name returned by the Identity Provider. In the **Attribute Schema Name** column, type the Identity Provider attribute name. For OAuth Providers, **Attribute Name** values and **Attribute Schema Name** values are usually the same.

**Note:**

LinkedIn does not return an e-mail address or an unencrypted login ID when it returns User Identity attributes to Mobile and Social. Please note this limitation when using Identity attributes from LinkedIn to pre-populate the registration form for Users.

[Table 50-5](#) and [Table 50-6](#) lists the user attributes supported by Foursquare and Windows Live.

**Table 50-5 User Profile Attributes Returned By Foursquare**

Attribute	Description
id	Requests the user's ID.
firstname	Requests the user's first name.
lastname	Requests the user's last name.
contact.email	Requests the user's email address.
homecity	Requests the user's home city.
gender	Requests the user's gender.
photo	Requests the user's photo.

**Table 50-6 User Profile Attributes Returned By Windows Live**

Attribute	Description
id	Requests the user's ID.
first_name	Requests the user's first name.
last_name	Requests the user's last name.
name	Requests the user's name.
link	Requests the user's link.
email.preferred	Requests the user's preferred e-mail address.
gender	Requests the user's gender.
locale	Requests the user's local.
updated_time	Requests the updated time.

- Custom: In the **Attribute Name** column type the local application attribute name that should be assigned to the attribute name returned by the Custom Identity Provider. In the **Attribute Schema Name** column, type the URL where the Mobile and Social server can request user data from the Identity Provider.

6. Click **Create** to create the Social Identity Provider configuration object.

## 50.3.2 Editing or Deleting a Social Identity Provider

You can edit or delete a Social Identity Provider.

Select the Provider in the panel and click **Edit** or **Delete** on the panel's tool bar. See [Creating a Social Identity Provider](#) for attribute descriptions.

## 50.3.3 Generating the Consumer Key and Consumer Secret for OAuth Providers

The following sections describe how to generate the Consumer Key and Consumer Secret for the Social Identity Providers that support the OAuth protocol.

- [Generating a Consumer Key and Consumer Secret for Facebook](#)
- [Generating a Consumer Key and Consumer Secret for Twitter](#)
- [Generating a Consumer Key and Consumer Secret for LinkedIn](#)
- [Generating a Consumer Key and Consumer Secret for Foursquare](#)
- [Generating a Consumer Key and Consumer Secret for Windows Live](#)
- [Generating a Consumer Key and Consumer Secret for Google](#)

---

---

**Note:**

The steps in this section are accurate as of the date that this documentation was published. The steps required to create a Consumer Key and Consumer Secret using the Facebook, Twitter, and LinkedIn web sites are subject to change at any time.

---

---

### 50.3.3.1 Generating a Consumer Key and Consumer Secret for Facebook

You can generate a Consumer Key and Consumer Secret for Facebook.

To generate:

1. Open the following URL in a web browser:

<https://developers.facebook.com/apps>

2. Click **Create New App**.
3. Complete the Create New App form.

Facebook creates the application and assigns it a unique App ID and App Secret.

4. Complete the information in the **Basic Info** section.

In the **Select how your application integrates with Facebook** section, select **Website with Facebook Login**.

5. In the **Site URL** field, provide the URL where the Mobile and Social Server can be reached. For example:

`http://OAM-Hosted-Machine: Port /`

6. Click **Save Changes**.

7. From the Mobile and Social Console, open the "Social Identity Providers" > "Facebook" configuration page as described in section [Editing or Deleting a Social Identity Provider](#).

8. Paste the App ID in the **Consumer Key** field and paste the App Secret in the **Consumer Secret** field.

Click **Apply** to save your changes.

### 50.3.3.2 Generating a Consumer Key and Consumer Secret for Twitter

You can generate a Consumer Key and Consumer Secret for Twitter.

To generate:

1. Open the following URL in a web browser:

<https://dev.twitter.com/apps/new>

2. Complete the Create an application form.

In the **Callback URL** field provide the URL where the Mobile and Social Server can be reached. For example:

`http://OAM-Hosted-Machine:Port/oic_rp/return`

Twitter creates the application and assigns it a unique Consumer key and Consumer secret.

3. (Optional) Configure your Twitter application as needed and save your changes.
4. From the Mobile and Social Console, open the "Social Identity Providers" > "Twitter" configuration page as described in section [Editing or Deleting a Social Identity Provider](#).
5. Paste the Consumer Key in the **Consumer Key** field and paste the Consumer Secret in the **Consumer Secret** field.

Click **Apply** to save your changes.

### 50.3.3.3 Generating a Consumer Key and Consumer Secret for LinkedIn

You can generate a Consumer Key and Consumer Secret for LinkedIn.

To generate:

1. Open the following URL in a web browser:

<https://www.linkedin.com/secure/developer?newapp=>

2. Complete the Add New Application form.

In the **OAuth User Agreement** section, add the URL in the **OAuth Redirect URL** field where the Mobile and Social Server can be reached. For example:

`http://OAM-Hosted-Machine:Managed Server Port/`

3. Click **Add Application**.

LinkedIn creates the application and assigns it a unique API Key and Secret Key.

4. From the Mobile and Social Console, open the "Social Identity Providers" > "LinkedIn" configuration page as described in section [Editing or Deleting a Social Identity Provider](#).
5. Paste the API Key in the **Consumer Key** field and paste the Secret Key in the **Consumer Secret** field.

Click **Apply** to save your changes.

#### 50.3.3.4 Generating a Consumer Key and Consumer Secret for Foursquare

You can generate a Consumer Key and Consumer Secret for Foursquare.

To generate:

1. Open the following URL in a web browser:  
<https://foursquare.com/developers/register>
2. Fill in the application name and website URL.
3. Enter the URL where the Mobile and Social Server can be reached in the Callback URL field.

For example:

`http://OAM-Hosted-Machine:Port/`

4. Save your changes.  
From the screen that is displayed, copy the 'Client ID' and 'Client secret' codes.
5. From the Mobile and Social Console, open the "Social Identity Providers" > "Foursquare" configuration page as described in section [Editing or Deleting a Social Identity Provider](#).
6. Paste the Client ID in the **Consumer Key** field and the Client Secret in the **Consumer Secret** field and click **Apply** to save your changes.

#### 50.3.3.5 Generating a Consumer Key and Consumer Secret for Windows Live

You can generate a Consumer Key and Consumer Secret for Windows Live.

To generate:

1. Open the following URL in a web browser:  
<https://manage.dev.live.com/>
2. Sign in with your Windows Live ID and password.
3. Click **Create Application**.
4. Fill in the application name.
5. Read and accept the terms of use.

From the screen that is displayed, copy the 'Client ID' and 'Client secret' codes.

6. From the Mobile and Social Console, open the "Social Identity Providers" > "Windows Live" configuration page as described in section [Editing or Deleting a Social Identity Provider](#).

7. Paste the Client ID in the **Consumer Key** field and the Client Secret in the **Consumer Secret** field and click **Apply** to save your changes.

### 50.3.3.6 Generating a Consumer Key and Consumer Secret for Google

You can generate a Consumer Key and Consumer Secret for Google.

To generate:

1. Open the following URL in a web browser:

<https://code.google.com/apis/console>

2. Under APIs & auth (on the left side) click **Credentials**.

3. Under OAuth click **Create new Client ID**.

The Create Client ID form opens.

4. Complete and submit the form.

The new Client ID and secret are added.

5. From the Mobile and Social Console, open the "Social Identity Providers" > "Google" configuration page as described in section [Editing or Deleting a Social Identity Provider](#).

6. Paste the Client ID in the **Consumer Key** field and the Client Secret in the **Consumer Secret** field.

Click **Apply** to save your changes.

## 50.3.4 Troubleshooting Facebook Social Identity Providers

This section documents known configuration issues that affect the Facebook Social Identity Provider.

- [Configuring WebLogic Server for Facebook Compatibility](#)
- [Configuring WebLogic Server 10.3.5 and Older for Facebook Compatibility](#)

### 50.3.4.1 Configuring WebLogic Server for Facebook Compatibility

You can configure WebLogic Server from the WebLogic Console to support Facebook.

To configure:

1. Open the WebLogic Console.

`http://host:port/console`

2. Choose *Domain* > **Environment** > **Servers** > *Managed Server*.

3. Click the **SSL** tab, then click **Advanced**.

4. Click **Lock and Edit** configuration.

5. Change the **Host Name Verifier** to None.

6. Restart the Managed Server.



If **Host Name Verifier** is not set to **None**, the following error may display when trying to access a protected resource if Facebook is the Identity Provider:

```
Exception in processRequest method: oracle.security.idaas.rp.RPException:
oracle.security.idaas.rp.RPException: Request failed:
```

#### 50.3.4.2 Configuring WebLogic Server 10.3.5 and Older for Facebook Compatibility

Facebook's SSL certificate contains \*.facebook.com as a wildcard host identifier. WebLogic Server versions 10.3.5 and older have a problem verifying host names that contain wildcards that can lead to communication failures between Facebook and installations of Oracle Access Management Mobile and Social deployed on WebLogic Server.

The following workarounds are available:

- If using WebLogic Server versions 10.3.5 or older, follow these steps:
  1. In the administration console, choose **servers > oam\_server\_where\_Mobile\_and\_Social\_is\_deployed > SSL > Advanced**.
  2. Change **Hostname Verifier** to **NONE**.
- This WebLogic Server bug has been fixed in version 10.3.6 as follows: A new custom host name verifier `SSLWLSWildcardHostnameVerifier` was implemented, derived from the default host name verifier, so that it supports everything the default host name verifier does, including SANs. You must configure your WebLogic server to use this custom host name verifier if support for wildcard certificates is required during the SSL handshake. One option is to use the following WebLogic property:
 

```
-
Dweblogic.security.SSL.hostnameVerifier=weblogic.security.utils.SSLWLSWildcardHostnameVerifier
```

## 50.4 Defining Service Provider Interfaces

The Service Provider Interface refers to the set of rules that govern the authentication flow for the specified Application Profile.

Mobile and Social provides the following Service Provider Interfaces.

- **DefaultServiceProviderInterface** - provides support for web applications that run on Java-compliant application servers.
- **OAMServiceProviderInterface** - provides support for web applications that run on the Access Manager service.

If necessary, a Java developer can write custom implementations of one or more of the Identity Provider interface contracts. This section includes the following topics:

- [Creating a Service Provider Interface](#)
- [Editing or Deleting an Service Provider Interface](#)
- [Adding a Custom Service Provider Interface Implementation](#)

### 50.4.1 Creating a Service Provider Interface

You can create a Service Provider Interface from the Social Identity Home Page.

1. Open the Social Identity Home Page in the Oracle Access Management Console as described in [Opening the Manage Social Identity Page](#).
2. Click **Create** in the **Service Provider Interface** panel in the home area.  
The Create New Service Provider Interface configuration page displays.
3. Enter values for the Service Provider Interface properties.
  - **Name** - Type a unique name for this Authentication Service Provider.
  - **Description** - (Optional) Type a short description that will help you or another Administrator identify this service in the future.
4. Enter values for the Interface Information properties as specified in [Table 50-7](#).

**Table 50-7 Service Provider Interface Information Properties**

Name	Notes
IDP Selector	Choose the IDP Selector implementation class for the custom Provider. NOTE: The console will not check the validity of the provided class.
Post IDP Selector	Choose the Post IDP Selector implementation class for the custom Provider.
IDP Interaction Provider	Choose the IDP Interaction Provider implementation class for the custom Provider.
Registration Status Check	Choose the Registration Status Check implementation class for the custom Provider.
Session Creation Provider	Choose the Session Creation Provider implementation class for the custom Provider.

5. Click **Create** to create the Service Provider Interface configuration object.

## 50.4.2 Editing or Deleting an Service Provider Interface

You can edit or delete a Service Provider Interface.

Select the Provider in the panel and click Edit or Delete on the panel's tool bar. See [Creating a Service Provider Interface](#) for attribute descriptions.

## 50.4.3 Adding a Custom Service Provider Interface Implementation

To add a custom interface implementation, You can create a new Social Identity Provider and choose a mix of custom and/or default implementation classes as needed to meet your business objectives.

See "Developing Applications Using the Social Identity Client SDK" in the *Oracle Fusion Middleware Developer's Guide for Oracle Access Management* for information.

## 50.5 Defining Application Profiles

An Application Profile defines an application that uses Social Identity Provider services on the Mobile and Social server.

Use this panel to configure mobile applications, web applications that run on Java-compliant application servers, and web applications that are integrated with Access Manager to use Social Identity.

- If a web application is not integrated with Access Manager, integrate the Social Identity login page with the web application. See the "Developing Applications Using the Social Identity Client SDK" chapter in the *Oracle Fusion Middleware Developer's Guide for Oracle Access Management* for details.
- If the web application is integrated with Access Manager, edit the preconfigured Application Profile named OAMApplication. When Access Manager and Mobile and Social are installed together during Oracle Access Management installation, both products are registered as trusted partners and the preconfigured Application Profile is included. As a result, you do not need to write code to integrate web applications that are integrated with Access Manager and Social Identity. The OAMApplication Application Profile that is included with Mobile and Social is preconfigured to work with Access Manager and requires only minor configuration changes to get working in your environment.

Typically, when a WebGate is configured in Access Manager, an Application Domain is created involving resources and policies. In Mobile and Social, OAMApplication is the Application Profile that corresponds to the Access Manager Application Domain. So, if you define 10 WebGates in Access Manager, and each represents an application that needs to use Mobile and Social for user authentication, use OAMApplication as a template to create 10 corresponding Application Profiles with names that match the 10 Application Domains.

---

---

**Note:**

When you install a WebGate to protect an application in Access Manager, the WebGate setup automatically creates an Application Domain that has LDAP as the authentication mechanism. To use Mobile and Social authentication, change the Authentication Scheme to OICScheme.

---

---

This section provides help for the Create Application Profile wizard and the Edit Application Profiles page.

The following sections contain more information.

- [Creating an Application Profile](#)
- [Editing or Deleting an Application Profile](#)

### 50.5.1 Creating an Application Profile

You can create an application profile.

The following steps describes how to create an application profile:

1. Access the Manage Social Identity page as described in [Opening the Manage Social Identity Page](#).
2. Click **Create** in the **Application Profiles** panel in the home area.  
The Create New Application Profile configuration page displays.
3. Enter values for the general Application Profile properties.

- **Name** - Displays the context name of the web application or mobile application. This name should match the name registered with the agent protecting the resource. If the application is integrated with Access Manager, the Application Domain name as defined in Access Manager is displayed. This should be the same value as that of the Name defined in the Mobile and Social Services Application Profile, if applicable.
- **Description** - (Optional) Type a short description that will help you or another Administrator identify this service in the future.
- **Shared Secret** - For mobile or web applications, provide the security secret that the application and the Mobile and Social server share to facilitate secure communication. This is needed to use the Mobile and Social user registration functionality. It can be any string.
- **Return URL** - This value is not used if the application is a mobile application but it is a mandatory attribute. So for mobile applications, use the Mobile Application Return URL. For web applications, provide the URL that Mobile and Social should use to send back authentication responses. If the application is integrated with Access Manager, provide the following URL which Mobile and Social uses to send back authentication responses:  

```
http://oam-host:port/oam/server/dap/cred_submit
```
- **Mobile Application Return URL** - For mobile applications, provide the URL that Mobile and Social should use to send back authentication responses. This value should match the mobile application's return URL.

4. Enter values for the following Application Profile configuration properties.

- **Login Type** - If configuring a non-mobile application, choose **Local Authentication and Social Identity Provider Authentication** if the User login page should let users choose between authenticating locally and authenticating using an Identity Provider. If configuring either a mobile application or a non-mobile application, choose **Social Identity Provider Authentication only** if the User login page should not give the users the option of authenticating locally.

The Mobile and Social login page supports Social Identity Provider Authentication only. Local login is not supported.

---

---

**Note:**

If configuring a mobile application, choose **Social Identity Provider Authentication only** from the **Login Type** menu. The **Local Authentication and Social Identity Provider Authentication** option is not valid for mobile applications.

---

---

- **Enable Browser Popup** - Choose **Yes** if the login page should open in a pop-up window. This value should be false if this is a mobile application.
- **User Registration** - Choose **Enabled** to allow users to register with the application after authenticating against a Social Identity Provider. The login page for the application will show a User Registration form and prompt the User to register. The User can complete the form and register, or click the Skip Registration button. Choose **Disabled** if the login page should not show a User Registration form and should not prompt the User to register.

- **Registration URL** - Type the URL that the system should forward the User to so that the User can register for a local account. Typically the User is directed to a form with fields that correspond to the registration service attributes defined in the Application Profile. An encrypted token with attribute objects in a map are also passed to the client application as a parameter. These attributes are used to pre-populate the registration page with the User's profile data.
  - **UserID Attribute** - Type the attribute name that is used to uniquely identify the User. This attribute name should also appear in the **Application User Attribute** section of the Application Profile Configuration page.
  - **User Profile Service Endpoint** - Choose the User Profile Service endpoint that the application should use. The User Profile Service directs the application to the LDAP Directory service where the User will be created upon registration. User Profile Service endpoints are configured in Mobile and Social Services.
  - **Authentication Service Endpoint** - The Authentication Service endpoint determines how the user should be authenticated when local login is requested. If a mobile application, choose `InternetIdentityAuthentication` or any custom authentication of the type `InternetIdentityAuthentication`.
    - Choose `/oamauthentication` to forward the authentication request to Access Manager. The authentication scheme associated with the Mobile and Social Authentication Policy inside the IAMSuite Application domain determines how the user will be authenticated.
    - Choose `/internetidentityauthentication` to use the Identity Store specified in the corresponding endpoint.
  - **Application Profile Properties** - Click **Add** to add Application Profile attributes to the table. The following are supported.
    - `app.passwd.field` - Encrypts the password on the registration page. Add `password` as the value. To mask the password with asterisks (\*) on the registration page, add the `app.passwd.field` property and add `password` as the value.
    - `oic.app.idp.oauth.token` - Instructs Mobile and Social to include the OAuth Access Token as part of the final redirect to the application. Add `true` as the value. Only applies if the User selected an OAuth provider (Facebook, Twitter, LinkedIn).
    - `oic.app.user.token` - Creates a JWT User Token when a User authenticates with an Identity Provider and gets redirected back to the application. Add `true` as the value. This token contains the Identity Provider related URI and the User identifier value on record with the Identity Provider. Use this token to access other protected Mobile and Social REST services, for example the User Profile REST Service.
5. Click **Add** to add the Application User Attributes that the Social Identity Provider should return to the application after authentication.

Configure more details for these attributes in the following Registration Service Details with Application User Attribute Mapping step.

6. Add rows to the Registration Service Details with Application User Attribute Mapping table to map local (User) registration attributes to the application attributes provided by the Social Identity Provider.

Add any additional Application User Attributes in the previous step first. The following definitions apply to the Registration Service Details with Application User Attribute Mapping table properties.

- **Registration Service Attribute** - Choose from the menu the registration service attribute to configure.
- **User Attribute Display Name** - For the attribute in the **Registration Service Attribute** column, type the name that should appear on the User registration form. This is the attribute name that the user sees.
- **Read-only** - Select to prevent the user from updating the attribute value. The attribute value will display grayed-out on the form and the user will be blocked from making updates.

---

**Note:**

Do not select the **Read-only** option for *First Name* and *Last Name* if Yahoo is the Social Identity Provider. Yahoo does not return values for these attributes. Selecting the Read-only option will cause user registration to fail and an exception error to display.

---

- **Mandatory** - Select to make the attribute a required item on the user registration form.
  - **Application User Attribute** - Choose the attribute that corresponds to the attribute in the Registration Service Attribute column.
7. Click **Next** to configure the Service Provider Interface.  
The Service Provider Interface page displays.
  8. Choose the DefaultServiceProviderInterface from the drop down menu.  
For information about the Service Provider Interface, see [Defining Service Provider Interfaces](#).
  9. Click **Next** to configure the Social Identity Provider.  
The Social Identity Provider page displays. Use this section to select one or more Social Identity Providers, and to map local application user attributes to Social Identity Provider attributes. For example, to use an e-mail address as the unique local user identifier when Google is the Social Identity Provider:
    - a. Select **Google** in the **Social Identity Provider** column.  
A two-column table opens.
    - b. Create the mapping as follows:
      - i. Choose **uid** in the first row of the **Application User Attribute** column.
      - ii. Choose **e-mail** in the **Social Identity Provider User Attributes** column.
  10. Click **Finish** to create the **Application Profile**.

## 50.5.2 Editing or Deleting an Application Profile

You can edit or delete an Application Profile.

Select the Profile in the panel and click Edit or Delete on the panel's tool bar. See [Creating an Application Profile](#) for attribute descriptions.

## 50.6 Integrating Social Identity With Mobile Applications

You can configure Mobile and Social Services to allow applications on mobile devices to authenticate using Social Identity.

Any application that needs to use Social Identity must have a corresponding Application Profile in Social Identity. If you want a mobile application to use Social Identity, the application needs to have a profile under Social Identity and under Mobile and Social Services.

1. Under Social Identity, open the Create Application Profile wizard.
2. Populate the Application Profile attributes with values applicable to the mobile application being protected and click Next.

See [Creating an Application Profile](#) for attribute definitions.

3. Select the Service Provider Interface and click Next.

See [Defining Service Provider Interfaces](#).

4. Select the Social Identity Provider and click Next.

See [Understanding Social Identity Configuration](#).

5. View the Application Profile summary and click Finish to create the Application Profile.

6. Under Mobile and Social Services, open the Create Service Domain wizard.

If modifying an existing Service Domain, open it for editing. See [Defining Service Profiles](#) for information.

7. Complete the form as follows.

- For **Type**, select **Mobile Application**.
- For **Authentication Scheme**, select **Social Identity Authentication**.

See [Defining Service Domains](#) for information.

8. In the **Application Profile Selection** section, add the Mobile and Social Services Application Profile that represents the mobile application being protected and choose if it will participate in mobile SSO as an agent, a client or not at all.

Select the appropriate Application Profile by browsing existing Profiles or entering a name. The Application Profile must already be created. (To create Mobile and Social Services Application Profiles, see [Defining Application Profiles](#); for Social Identity Application Profiles, see [Defining Application Profiles](#).)

9. Click **Next** to select (or create) a Service Profile.

See [Defining Service Profiles](#).

10. Click **Next** to select the Service Protection.

For example, use `InternetIdentityAuthentication` as the authentication service to protect the User Profile Services.

11. Click **Next** to view the Create Service Domain summary.

12. Click **Finish** to create the Service Domain.

---

---

**Note:**

See "Integrating Social Identity With a Mobile Application" in the "Developing Applications Using the Social Identity Client SDK" chapter of the *Oracle Fusion Middleware Developer's Guide for Oracle Access Management* for more information.

---

---

## 50.7 Linking Social Identity Provider Accounts

Social Identity Account Linking allows users to link several Internet identities together with an existing or new local user account.

The following sections contain information about how to enable and use this feature.

- [Social Identity Provider Account Linking Flow](#)
- [Social Identity Provider Account Linking Configuration](#)

### 50.7.1 Social Identity Provider Account Linking Flow

When a user logs in successfully as a local user using an Identity Provider, the Linked Accounts page is displayed. The user can link the Identity Provider to this local account from the Linked Accounts page.

The following sequence documents the steps in the Account Linking Flow.

1. The user lands at the Mobile and Social Login Page.
2. The user is prompted to log in locally or with an Identity Provider.
3. The user selects Identity Provider Login (for example, Google) and enters password credentials.

Once authenticated (and if determined that the user is already registered with a local account), the user is automatically logged in as the local user and then presented with a Linked Accounts page that has the option to link the Identity Provider to this local account.

By clicking the link next to Google, the user will link the local account to the Google Identity Provider account. The user may choose to link and unlink additional Identity Providers from this page. [Figure 50-1](#) illustrates this scenario.

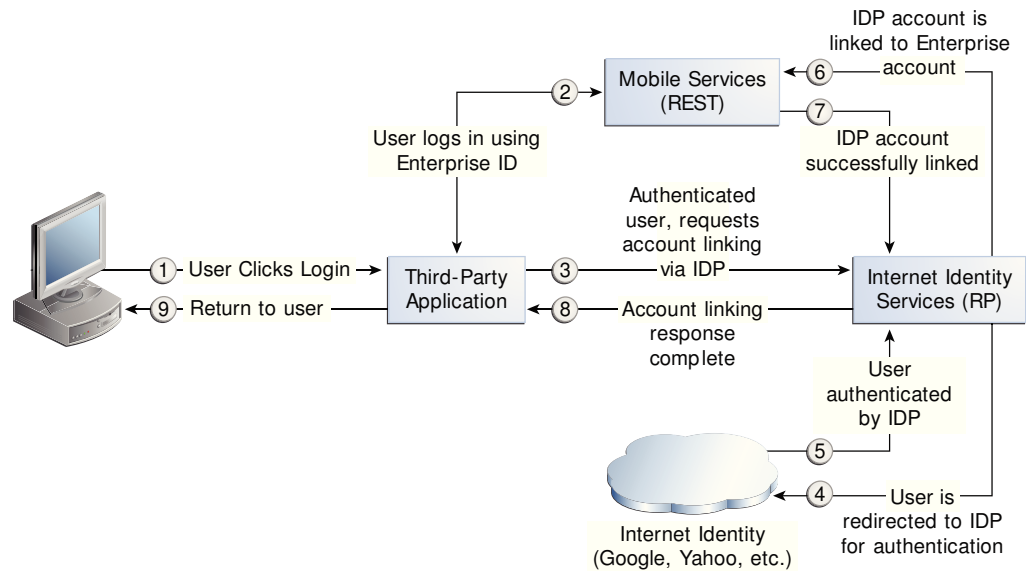

**Figure 50-1 Social Identity Account Linking**

Additional scenarios include:

- If the user logs into an Identity Provider account without having a local account and selects the Register option after Identity Provider authentication, an enterprise ID will be created and the Identity Provider account will be automatically associated with this enterprise ID. In other words, the user logs in with the Identity Provider Login ID and Mobile and Social creates a local account with the same user name as the Identity Provider Login ID. The user is then redirected to the linked accounts page associated with the newly created local account. From this page, the user may choose to link or unlink Identity Provider accounts or return back to the application.
- If the user logs in using the local account only, in the app the user has to choose the linked accounts page displaying Identity Providers. From this page, the user may choose to link (or unlink) Identity Provider accounts or return back to the app. When the accounts are linked, Social Identity will detect that the user is linked to a local account even when the user logs in using Identity Provider credentials.

---

**Note:**

The linked accounts page can be provided by the relying party (by way of Social Identity) or a third-party application that hosts the options for linking accounts. In either case, the following items will need to be provided:

- An API call (for example, `AccountLinkingHelper.getProviders()`) listing the various Identity Providers that can be linked. This will include linkage status and IDs.
  - An RP-specific account linking page (for example, `linkedAccounts.jsp`) that will display the various Identity Providers that can be linked. This will include linkage status and IDs.
-

## 50.7.2 Social Identity Provider Account Linking Configuration

You can configure Social Identity Provider Account Linking properties and enable account linking.

The properties documented in [Table 50-8](#) need to be configured to use Account Linking. They are set in the Application Profile Properties table.

**Table 50-8 Account Linking Properties**

Property	Details
<code>app.acct.link.enabled</code>	This configuration property is set to true to enable Account Linking.
<code>app.acct.link.attr</code>	Specify the OAM entity attribute name that corresponds to the LDAP attribute where the multi-valued account linking information is to be stored. Use the OAM entity attribute name defined in the IDS Profile. To look up this name in the OAM console, choose <b>Configuration &gt; User Identity Stores &gt; IDS Profiles</b> . Select the identity profile and click edit, then click <b>Entity Attributes</b> . The Entity Attributes page lists both the entity attribute names defined by OAM, and the corresponding LDAP physical attributes. Use the OAM name listed in the first column. Note: This value is case-sensitive.

The following should also be taken into account when enabling Account Linking.

- Ensure the proxy setting is correct. This setting can be found by navigating the Oracle Access Management Console: **System Configuration > Mobile & Social > Mobile & Social Settings**.
- Images for Identity Provider icons or logos can only be specified using WLST. If the image path starts with `http`, the image is retrieved from the location using the `img` tag. Otherwise, it uses the internal references that come with Social Identity.
- Ensure that the username attribute and the account linking attribute are different. If they are the same then it can cause inconsistent behavior. For example, you can set the username attribute to `uid` and the linking attribute to `mail`.
- Set the Shared Secret for the application. Set the Auth Scheme on the authentication policy to point to `OICScheme` and ensure that the settings are correct. For example, the `MatchLDAPAttribute` should match the username attribute set in the relying party Application Profile, typically `uid`.

---

# Configuring Social Identity System Settings

You need to configure the Social Identity System settings for the Oracle Access Management Social Identity.

You need to perform the following tasks to configure the Social Identity System settings:

- [Accessing the Social Identity Settings Interface](#)
- [Logging and Auditing](#)
- [Deploying Mobile and Social With Oracle Access Manager](#)
- [Configuring Social Identity After Running Test-to-Production Scripts](#)
- [Configuring Social Identity for High Availability \(HA\)](#)
- [Enabling the REST Client to Specify a Tenant Name](#)

## 51.1 Accessing the Social Identity Settings Interface

Use the Social Identity Settings page in the Oracle Access Management Console to configure system level settings.

You can perform many Social Identity configuration tasks from the command line using the WebLogic Scripting Tool (WLST). See the *Oracle Fusion Middleware WebLogic Scripting Tool Command Reference*.

To access the Social Identity settings interface:

1. In the Oracle Access Management Console, click **Configuration** at the top of the window.
2. Select **Social Identity** from the **View** menu in the **Settings** section.

### 51.1.1 Social Identity Settings Page

You can configure Social Identity settings if a proxy server is in place between the Social Identity server and an Identity Provider.

The form fields on the Social Identity Settings page are as follows:

- **Proxy URL** - Choose the protocol to use to connect to the proxy server (HTTP or HTTPS), then type the proxy server host name and port number.
- **Proxy Authentication** - Type the user name and password required to authenticate with the proxy server.
- **SAE Token Validity Period** - Type the number of seconds that the system should wait before expiring the Secured Attribute Exchange token. SAE is the default

scheme used to secure communication between the Social Identity server and any application integrating directly with Social Identity.

## 51.2 Logging and Auditing

See "Monitoring Oracle Fusion Middleware" in the *Administering Oracle Fusion Middleware* for information about Fusion Middleware logging.

See "Configuring and Managing Auditing" in the *Securing Applications with Oracle Platform Security Services*.

## 51.3 Deploying Mobile and Social With Oracle Access Manager

Mobile and Social can be configured for use with either Oracle Access Manager 10g or 11gR1 PS1.

For this to work, however, Oracle Access Manager and Mobile and Social need to be installed on different servers in different domains. Mobile and Social and Oracle Access Manager then need to be configured to work together. The following procedure documents how to do this using Oracle Access Manager 11gR1 PS1. **Before you Begin** - Install Social Identity on Host 1 and Oracle Access Manager 11gR1 PS1 on Host 2.

To deploy mobile and social with Oracle Access Manager:

1. Log on to the Oracle Access Management Console on Host 2 and create a Webgate profile for Social Identity using the default settings.
2. In Social Identity, create an Authentication Service Provider for Oracle Access Manager 11.1.1.5.

See [Creating an Authentication Service Provider](#).

Set the Attributes as described in the following table.

**Table 51-1 Attribute Settings for an Oracle Access Manager 11gR1 PS1 Authentication Service Provider**

Name	Value
OAM_VERSION	OAM_10G
DEBUG_VALUE	0
TRANSPORT_SECURITY	OPEN
OAM_SERVER_1	<i>host:port</i>
OAM_SERVER_1_MAX_CONN	4
OAM_SERVER_2	<i>host:port</i>
OAM_SERVER_2_MAX_CONN	4
AuthNURL	wl_authen://Authen/Basic

3. In Social Identity, create a Service Profile for the Authentication Service Provider that you created in the previous step.

See [Defining Service Profiles](#).

4. In Social Identity, create a Service Domain.

See [Creating a Service Domain](#).

5. Merge the `cwallet.sso` file on Host 2 with the `cwallet.sso` file on Host 1 as follows:

a. Copy `cwallet.sso` from Host 2 to Host 1.

b. On Host 1 type

```
mkdir /tmp/oam /tmp/oic# cp <host>/cwallet.sso /tmp/oam # cp config/fmwconfig/
cwallet.sso /tmp/oic
```

c. Create file `merge-creds.xml`:

```
<?xml version="1.0" encoding="UTF-8" standalone="yes"?>
<jpsConfig xmlns="http://xmlns.oracle.com/oracleas/schema/11/jps-config-11_1.xsd"
xmlns:xsi="http://www.w3.org/2001/XMLSchema-instance"
xsi:schemaLocation="http://xmlns.oracle.com/oracleas/schema/11/jps-config-11_1.xsd"
schema-major-version="11" schema-minor-version="1">
 <serviceProviders>
 <serviceProvider
class="oracle.security.jps.internal.credstore.ssp.SspCredentialStoreProvider"
name="credstoressp" type="CREDENTIAL_STORE">
 <description>File-based credential provider</description>
 </serviceProvider>
 </serviceProviders>
 <serviceInstances>
 <!-- Source file-based credential store instance -->
 <serviceInstance location="/tmp/oam" provider="credstoressp"
name="credential.file.source">
 </serviceInstance>
 <!-- Destination file-based credential store instance -->
 <serviceInstance location="/tmp/oic" provider="credstoressp"
name="credential.file.destination">
 </serviceInstance>
 </serviceInstances>
 <jpsContexts>
 <jpsContext name="FileSourceContext">
 <serviceInstanceRef ref="credential.file.source"/>
 </jpsContext>
 <jpsContext name="FileDestinationContext">
 <serviceInstanceRef ref="credential.file.destination"/>
 </jpsContext>
 </jpsContexts>
</jpsConfig>
```

d. Set the path variable to include `$MW_HOME/oracle_common/bin`:  
`$MW_HOME/oracle_common/common/bin`

e. Execute the command to merge the `cwallet.sso` files:

```
wlst.shwlst:/> migrateSecurityStore(type="credStore", configFile="/tmp/
mergecreds.xml",src="FileSourceContext",dst="FileDestinationContext")
```

f. Copy the merged file to `config/fmwconfig`:

```
cp /tmp/oic/cwallet.sso /scratch/kerwin/wls10/user_projects/domain/base_domain/cfnfig/
fmwconfig
```

g. Restart the OAM Server on Host 1.

## 51.4 Configuring a Webgate to Support Social Identity

You can configure a Webgate for use with the OAuth Service. The Webgate serves as a proxy so that client authorization and token endpoint requests access the Webgate instead of accessing the Oracle Access Management server directly.

To configure a WebLogic environments only:

1. Install the Oracle HTTP Server 11g Webgate for OAM using the instructions in *Installing Webgates for Oracle Access Manager*.
2. Configure the Webgate by defining the following resource and creating an authentication policy and authorization policy.

- a. Open the Oracle Access Management console.
- b. Under **Access Manager**, click **Application Domains**.
- c. Find the target domain and open it for editing.
- d. Select the **Resources** tab.
- e. Create the following resource. If you are using the existing IAMSuiteAgent Host Identifier, the resource is already present and can be searched on using the **Resource URL** field.

```
/ms_oauth/oauth2/ui/**
```

Click to select the resource, then click the **Edit** button.

- f. Under the **Protection** heading, choose the following options from the menus and click **Apply**:

**Protection Level** - Protected

**Authentication Policy** - Protected HigherLevel Policy

**Authorization Policy** - Protected Resource Policy

These settings allow the Webgate to perform user authentication and user authorization.

- g. Add the following resources and set the **Protection Level** to **Excluded**:

```
/ms_oauth/oauth2/endpoints/**
/ms_oauth/oauth2/oammsui/**
/ms_oauth/style/**
/ms_oauth/img/**
/oam/**
```

The Webgate does not protect Excluded resources and allows them to be accessed.

3. Add the following lines to the `mod_wl_ohs.conf` file and restart the Webgate. For `WebLogicPort`, be sure to add the managed port details for your environment.

```
the following directive proxies all the OAuth requests
<IfModule weblogic_module>
 WebLogicHost host123.us.example.com
 WebLogicPort 17100
 Debug ON
```

```

 WLogFile /tmp/weblogic.log
 MatchExpression /ms_oauth/*
</IfModule>
the following directive proxies all the OAM managed server requests.

<IfModule weblogic_module>
 WebLogicHost host123.us.example.com
 WebLogicPort 17100
 Debug ON
 WLogFile /tmp/weblogic.log
 MatchExpression /oam/*
</IfModule>

```

4. Update the Access Manager Load Balancing settings as follows:
  - a. In the Oracle Access Management console, click **Configuration** at the top of the window.
  - b. Select **Access Manager** from the **View** menu in the **Settings** section.
  - c. In the **Load Balancing** section, change the **OAM Server Host** and the **OAM Server Port** settings to the Webgate's host and port settings.
  - d. Click **Apply**.
5. Complete the following steps.

- a. Open `$ORACLE_HOME/ORACLE_IDM1/oam/server/apps/` and locate the `oam-server.ear` file. For example:

```
cd /scratch/test/Oracle/Middleware/Oracle_IDM1/oam/server/apps
```

- b. Back up the `.ear` file:

```
cp oam-server.ear oam-server.ear.original
```

- c. Create a temporary directory and go to that directory:

```
mkdir tmp-ear
cd tmp-ear/
```

- d. Extract the `oam-server.ear` file into the `tmp-ear` directory:

```
jar -xvf ../oam-server.ear
```

- e. Create another temporary directory inside `tmp-ear` and go to that directory:

```
mkdir tmp-ms-war
cd tmp-ms-war
```

You should be in this directory:

```
/scratch/test/Oracle/Middleware/Oracle_IDM1/oam/server/apps/tmp-ear/tmp-ms-war
```

- f. Extract the `ms_oauth.war` into the `tmp-ms-war` directory:

```
jar -xvf ../ms_oauth.war
```

- g. Open the `WEB-INF/web.xml` file for editing and update it by adding comment tags around the `security-constraint` as follows:

```
<!-- BEGIN: Comment the following security constraint if either the OAM
Webgate is front-ending OAM in a WebSphere setup or if the WebLogic server
```

```

Domain Agent is not used.
<security-constraint>
 <web-resource-collection>
 <web-resource-name>OAuthSecuredResources</web-resource-name>
 <url-pattern>/oauth2/ui/*</url-pattern>
 </web-resource-collection>
 <auth-constraint>
 <role-name>valid-users</role-name>
 </auth-constraint>
</security-constraint>
END of security constraint needing to be commented -->

```

- h. Recreate the .war file in the tmp-ms-war directory:

```
jar cvf ms_oauth.war
```

- i. Copy the updated .war file to the parent directory, then remove the tmp-ms-war directory located in tmp-ear/:

```
cp /scratch/test/Oracle/Middleware/Oracle_IDM1/oam/server/apps/tmp-ear/tmp-
ms-war/ms_oauth.war /scratch/test/Oracle/Middleware/Oracle_IDM1/oam/server/
apps/tmp-ear
```

```
rm -rf /scratch/test/Oracle/Middleware/Oracle_IDM1/oam/server/apps/tmp-ear/
tmp-ms-war
```

- j. Create the oam-server.ear archive in the tmp-ear directory:

```
jar cvf oam-server.ear .
```

- k. Copy the tmp-ear/oam\_server.ear archive file to the parent directory:

```
cp /scratch/test/Oracle/Middleware/Oracle_IDM1/oam/server/apps/tmp-ear/oam-
server.ear /scratch/test/Oracle/Middleware/Oracle_IDM1/oam/server/apps/oam-
server.ear
```

- l. Restart the WebSphere server.

The Webgate will now reverse-proxy OAuth URLs as well as OAM managed server URLs. All authorization and token endpoint requests are now accessed using the Webgate host and port values instead of the actual OAM host and port values.

## 51.5 Configuring Social Identity After Running Test-to-Production Scripts

When you move Social Identity from a test environment to a production environment, you need to configure Social Identity on each production machine after you run the Test-to-Production scripts.

To configure Social Identity after running Test-to-Production scripts:

1. In the Oracle Access Management Console, click **Application Security**.
2. Click **Authentication Schemes** in the **Access Manager** section.
3. Find the OICScheme scheme and open it for editing.
4. Update the **Challenge Redirect URL** value to point to the production machine (not the test machine) and click **Apply**.

For example: `https://production_machine:port/oic_rp/login.jsp`



5. Run the following WLST command to update the Social Identity credential store framework (CSF) entry to point from the test machine to the production machine.

```
createCred(map="OIC_MAP", key=" https://<production machine host>:<production
machine port>/oam/server/dap/cred_submit ", user="=<description>", password="
DCC5332B4069BAB4E016C390432627ED", desc="<description>");
```

For `password`, use the value from the `RPPartner` entry, `TapCipherKey` attribute in `oam-config.xml`, located in the `domain home/config/fmwconfig` directory on the production machine.

6. In the Oracle Access Management Console:
  - a. Click **Mobile Security** at the top of the window.
  - b. Click **Mobile and Social Services**.
  - c. In the **Application Profiles** section, select **OAMApplication** and click **Edit**. (If using an application profile name other than `OAMApplication`, edit that instead.)
  - d. Update the **Registration URL** field host name and port to point to the production machine.
  - e. Click **Apply**.

## 51.6 Configuring Social Identity for High Availability (HA)

You can configure Social Identity for High Availability.

See "Configuring High Availability for Social Identity" in the *High Availability Guide* for information about configuring Social Identity High Availability.

## 51.7 Enabling the REST Client to Specify a Tenant Name

You can enable the REST client to specify the tenant name.

See "Specifying the Tenant Name in the Header" in the *Oracle Fusion Middleware Developer's Guide for Oracle Access Management*.

To enable the REST client:

1. Navigate to the following directory:

```
~/OAM-Domain-dir/bin
```

2. In a text editor, add the following line to the `./startManagedWebLogic.sh` file:

```
MT_OPTION="-Doracle.multitenant.headername=MY-MT-NAME"
JAVA_OPTIONS="${MY_OPTIONS} ${JAVA_OPTIONS}" export JAVA_OPTIONS
```

---



---

### Note:

If you do not specify the JVM option, the server will expect the client to use the default header name, `X-ID-TENANT-NAME`.

---



---

3. Save the file.



# Part XII

---

## Managing the Oracle Access Management OAuth Service

The Oracle Access Management OAuth Service allows organizations to implement the open standard OAuth 2.0 Web authorization protocol in an Access Manager environment. OAuth enables a client to access Access Manager protected resources that belong to another user (that is, the resource owner).

Part IX contains the following chapters:

- [Understanding OAuth Services](#)
- [Configuring OAuth Services](#)



---

## Understanding OAuth Services

OAuth provides a method to exchange identity credentials for an access token. This token, in return, can be used for granting access of private resources in a user's account on one service provider site to a second, consumer site without having to divulge the identity credentials to the consumer site.

Oracle Access Management implements the OAuth Core 2.0 specifications to offer OAuth Services. This chapter describes the purpose and capabilities of the Oracle Access Management OAuth Services.

This section describes the following topics:

- [About Oracle Access Management OAuth Services](#)
- [Understanding OAuth Services Authorization for Web Clients](#)
- [Understanding OAuth Services Authorization for Mobile Clients](#)
- [Understanding the OAuth Services Components](#)
- [About OAuth Services Tokens](#)
- [Understanding the Authorization and Authentication Endpoints](#)
- [Enforcing Access Control](#)
- [Understanding Mobile OAuth Services Server-Side Single Sign-on](#)
- [OAuth Services Plug-ins](#)

### 52.1 About Oracle Access Management OAuth Services

OAuth is an open standard authorization protocol that provides authentication and access control between a Client (including mobile apps and Web services) and a Resource Owner (or Service Provider) on the Web.

Oracle Access Management OAuth Services is based on this standard and designed:

- To address enterprise-level extranet use cases.
- To provide secure mobile access to APIs.
- To leverage built-in Oracle Access Management features (including authentication schemes, strong authentication, fraud detection, session management and federated authentication).
- To secure confidential clients with a high level of security.

Oracle Access Management OAuth Services are available for Web clients or for mobile clients. OAuth Services for Web clients implement the standard OAuth 2.0 use cases.

In this case, the clients rely on a Client ID/Client Password (or secret) to secure itself. For an example, see <http://tools.ietf.org/html/rfc6749#page-4>.

Mobile OAuth Services is an extension on top of the standard OAuth specification in which the identity of the mobile client is secured through application registration, and a credential specific to the mobile client is included with a request for access. As mobile clients store passwords on mobile devices, they can not be confidential like Web clients so the identity of the mobile client is established through device/app registration before accessing REST or Web services using the OAuth Services Access Token. Thus, the key difference between the standard Web and mobile OAuth Services use cases is that the mobile client is secure before it can request an Access Token (through device/app registration) whereas a standard OAuth Web client uses a credential like password or an assertion to self identify. See [Configuring OAuth Services in 12c](#) for details on configuring OAuth Services.

See Also,

- [Understanding OAuth Services Authorization for Web Clients](#)
- [Understanding OAuth Services Authorization for Mobile Clients](#)

## 52.2 Understanding OAuth Services Authorization for Web Clients

In the most common OAuth scenario, the Client accessing the protected resource is issued a different set of credentials than those of the user. (In this case, the user does not disclose their credentials to the client.) Oracle Access Management OAuth Services acts as the intermediary Authorization Server, interacting directly with the Client, the service hosting the user's protected resource (Resource Owner) and the server on which the resource is located (Resource Server).

It issues access tokens to a Client that has (already) successfully authenticated with the Resource Server - in effect, authorizing the client to access private resources or activities on the server. A single Authorization Server instance can issue access tokens accepted by multiple resource servers.

---

---

**Note:**

OAuth does not impose special requirements on the interaction between a Resource Server and an Authorization Server.

---

---

The following sections describe web-based scenarios in which OAuth Services works.

- [Understanding 3-Legged Authorization](#)
- [Understanding 2-Legged Authorization](#)

The scenarios introduce the concept of OAuth Services endpoints. For detailed information on these endpoints, see [Understanding the Authorization and Authentication Endpoints](#). The scenarios also use terms documented in [Understanding the OAuth Services Components](#) including the following:

- The Resource Owner refers to the user requesting access to a protected resource.
- The Client is the mobile app or Web service through which the Resource Owner is requesting access to a protected resource.
- OAuth Services refers to the Authorization Server, Oracle Access Management.

- The Resource Server is the machine on which the protected resource is stored. It can be any website or Web service where restricted resources are located; for example, a photo sharing site, a blogging platform and an online bank service control access to private resources and activities. The Resource Server is deployed in a different location from Oracle Access Management and the Client. The Resource Server needs to be capable of accepting and responding to protected resource requests using access tokens. The Resource Server must also validate the access token with OAuth Services as described in [Enforcing Access Control](#).

### 52.2.1 Understanding 3-Legged Authorization

In 3-legged authorization, the Resource Owner grants access to an OAuth-enabled Client to request access to resources stored on an OAuth protected Resource Server.

Oracle Access Management OAuth Services validates the Resource Owner's identity and presents the owner with a consent form in a Web browser when approval is required. The third leg in this authorization scheme is the step in which the user grants or denies the client access. The following text has more details and [Figure 52-1](#) illustrates the process.

---

---

**Note:**

A WebGate proxy is required to use 3-legged authorization with an external LDAP directory server. See [Configuring a WebGate to Protect OAuth Services](#) for details.

---

---

1. The Resource Owner (user) undertakes an action in the user-agent (a browser, for example) that requires the Client web service (or app) to access protected resources belonging to the user on a different site.
2. The Client initiates the OAuth flow by invoking the OAuth Services authorization endpoint to get a request token. The Client sends its identifier, the requested scope, and a redirection URI to which the Authorization Server will direct the user-agent once access is granted or denied.
3. OAuth Services redirects the user-agent to request the Resource Owner's password credentials.
4. Access Manager displays a login page requesting a user name and password from the Resource Owner. OAuth Services supports all authentication schemes provided by Access Manager.
5. The Resource Owner enters a user name and password.
6. Access Manager validates the credentials, returns a request token and redirects the user-agent to OAuth Services.
7. OAuth Services determines that the Resource Server requires the user's consent before the authorization code can be sent to the Client.
8. OAuth Services displays the user consent form.

Web-based clients require the consent form to be protected by a WebGate. For details, see [Configuring a WebGate to Protect OAuth Services](#).

9. The user approves the request.

10. OAuth Services returns an authorization code to the Client using the redirection URI.

---

---

**Note:**

The Authorization Code grant type is required for 3-legged authorization. See [Clients - Identity Federation and OAuth Services](#) for details.

---

---

11. The Client sends the authorization code in a POST request (including the redirection URI used to obtain the authorization code for verification) to the token endpoint and requests an OAuth access token. When making the request, the Client authenticates with OAuth Services.
12. If the client type requires client credentials, the OAuth Services authenticates the client credentials, validates the authorization code, and ensures that the redirection URI received matches the URI previously used to return the authorization code. OAuth Services also validates the requested scope based on the Resource Server's configuration and the user's consent details.
13. OAuth Services returns an access token to the Client.  
*A refresh token* may also be returned with the access token if the client sends a refresh token request. For more information, see [About OAuth Services Tokens](#).
14. The Client presents the access token to the Resource Server.
15. The Resource Server validates the access token by sending a request to the OAuth Services token endpoint and waits for a success or failure response.
16. OAuth Services validates and sends the token success or failure response back to the Resource Server.
17. If the token is deemed valid, the Resource Server returns the requested resource to the Client.

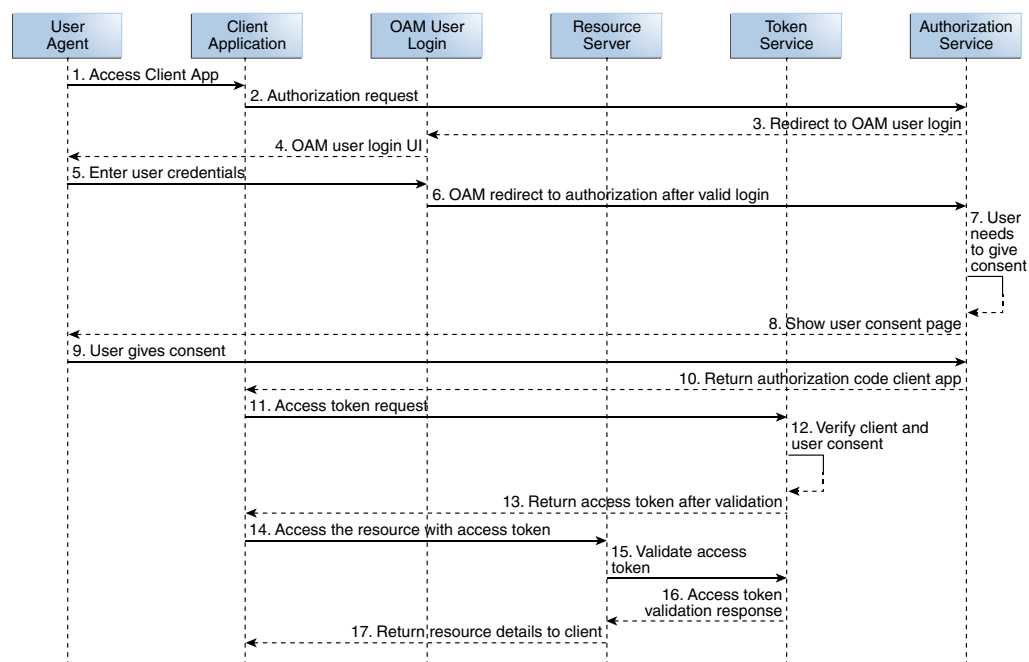

**Figure 52-1 OAuth 3-Legged Flow Diagram**

## 52.2.2 Understanding 2-Legged Authorization

In 2-legged authorization, the OAuth Client is pre-approved to access resources; thus, the user consent form step (described in [Understanding 3-Legged Authorization](#)) is not required. In this scenario, Access Manager returns a request token to the Client which the client sends to OAuth Services to request an access token. Because the request token is pre-authorized, OAuth token service returns an access token to the Client without displaying the consent form. This arrangement fits a service-to-service model, especially when the requesting service (Client) and the Resource Server are in a close partnership and Resource Owner approval is either assumed or not required.

---



---

### Note:

The Client Credentials grant type or the Resource Owner Credentials grant type are required for 2-legged authorization. See [Configuring Clients](#) for more information.

---



---

## 52.3 Understanding OAuth Services Authorization for Mobile Clients

The Mobile OAuth Services authorization scenario supports mobile apps that run in a browser as well as device-native apps that do not use a browser or just use the browser during user authentication.

This scenario provides enhanced security support (in addition to the baseline security measures defined in the OAuth 2.0 specification) including:

- Client apps must be registered with OAuth Services in the Identity Domain that your organization uses to manage Mobile OAuth Services clients.
- Mobile applications must register with Oracle Access Management prior to using OAuth Services and each registration is specific to one app on the device. After the application registration, the mobile app will have a client token. It uses this

token as the security credential for making Access Token requests. In comparison, the OAuth web client uses either a credential-like password or an assertion to identify itself.

- This scenario supports user consent management. If consent management is enabled, the client app prompts the user to accept or decline the app's request to register with Access Manager.

**Note:**

This consent is controlled with the "Require User Consent for Client Registration" attribute under the Service Profiles. If set, the user will be asked to confirm app registration; if off, the user will not be asked. See [Configuring Service Profiles](#).

- Except for access tokens (and user tokens if server-side SSO is disabled), the server does not send security material, such as OAAM device and session handles to the client on the mobile device, but stores it in the Server-Side Device Store. Access tokens are both sent to the client and stored in the Server-Side Device Store to provide for validation and life cycle management.
- The OAM server component can restrict token delivery to a specific app installed on a specific device by sending part of a token through HTTPS, and sending the other part through push notification using either the Apple Push Notification Service (APNS) or Google Cloud Messaging (GCM). [Figure 52-2](#) illustrates this.

**Figure 52-2 Using a Split Request to get a Client Verification Code**

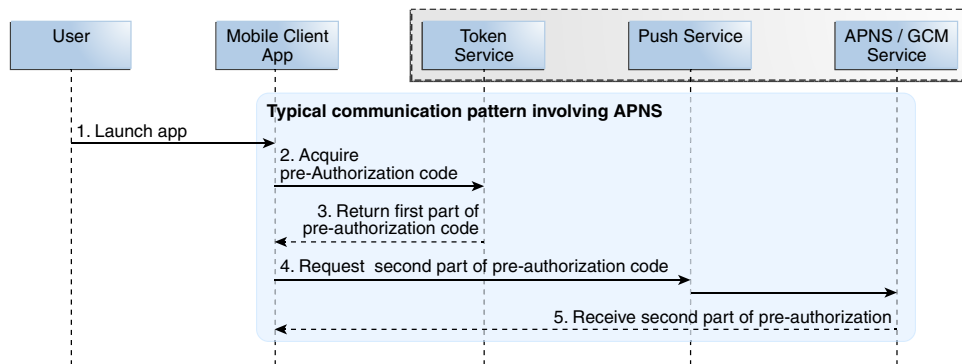

The following scenario describes the additional interactions that Oracle Access Management undertakes when authenticating with a mobile client. The process is illustrated in [Figure 52-3](#).

1. The Resource Owner opens the Client mobile app.  
An Oracle Access Management administrator has already registered this Client app as a Mobile OAuth Services Client.
2. The Mobile Client sends the client ID and the device token to OAuth Services and requests a client verification code.
3. OAuth Services returns half of the client verification code over HTTPS or HTTP.  
See [Figure 52-2](#). This behavior can be configured in the Mobile Service Settings section of the OAuth Services Profile configuration page.

- If the security level is set to **Advanced**, all codes and tokens are returned using both HTTP and push notification.
- If the security level is set to **Standard** mode, all codes and tokens are sent over HTTP only.

**The rest of this scenario (beginning with step 4) contains details for when the security level is set to Advanced.**

4. The Mobile client requests the second half of the client verification code from the OAuth Services push endpoint.  
The push endpoint forwards the request to the APNS or the GCM service depending on the mobile device's operating system.
5. The APNS or GCM service sends the second half of the client verification code to the Client app.
6. The Mobile client requests an authorization code from OAuth Services by sending the client verification code and the device token.
7. OAuth Services redirects the request to Access Manager.
8. Access Manager sends a login page to the user-agent so that the user can log in.
9. The Resource Owner (user) enters a user ID and password.
10. Access Manager validates the login and redirects to OAuth Services.
11. OAuth Services is configured to obtain the user's approval to register the device. (It will not ask for the user's consent to register if **Require User Consent for Client Registration** is disabled on the OAuth Services Profile Configuration page.)
12. The consent page is sent to the Resource Owner.
13. The Resource Owner provides (or denies) consent.
14. OAuth Services checks the Oracle Adaptive Access Manager (OAAM) plug-in to determine if additional authentication steps are required.
15. The plug-in determines that an additional challenge question is required.
16. The OAAM challenge question is sent to the Resource Owner.
17. The Resource Owner provides the challenge answer which is forwarded to the OAAM plug-in.
18. The OAAM plug-in validates the challenge answer.
19. OAuth Services uses the mobile redirect URI to return half of the authorization code that the mobile app will need to request a client token.
20. The Mobile OAuth Services client requests the second half of the authorization code from OAuth Services push endpoint.  
The push endpoint forwards the request to the APNS or GCM service.
21. The mobile client app receives the second half of the authorization code from the APNS or GCM service.

The mobile client app assembles the authorization code in preparation for requesting a client token.

22. After validating the authorization code, the Mobile OAuth client uses the code to request the first half of the client token from the OAuth Services token endpoint.
23. The token endpoint returns the first half of the client token to the mobile client.
24. The mobile client requests the second half of the client token from the OAuth Services push endpoint.
25. The APNS or GCM service sends the second half of the client token to the mobile client app.

The mobile client assembles the client token as well as a refresh token. The client can use the refresh token to request a new client token.

26. The mobile client prepares to request an access token by completing the following steps:
  - The Client requests and receives a client verification code from OAuth Services.
  - The Client requests and receives the first part of the authorization code from OAuth Services.
  - The resource owner does not need to log in if the user session is still valid.
  - User consent may be required based on the Resource Server scope to which the Client is requesting access.
  - The OAAM plug-in does not repeat its challenge.
  - The client requests the second part of the authorization code.

27. The APNS or GCM service returns the second half of the authorization code for the access token.

The Client assembles the authorization code in preparation for the access token request.

28. The mobile client requests an access token by sending the client token and the access token authorization code.
29. The token endpoint sends the access token to the client. This behavior depends on whether the Security Level setting in the Mobile Service Settings section of the OAuth Services Profile configuration page is set to Advanced or Standard.
30. The Mobile OAuth Services client requests access to the protected resources by sending the access token to the Resource Server.
31. The Resource Server validates the access token with the OAuth Services token service. The Resource Server can also validate the token locally. If the certificates are configured correctly, JWT token signing is verified at the Resource Server.
32. The OAuth Services token service sends a response to the Resource Server.
33. The Resource Server sends the requested resources to the mobile client.

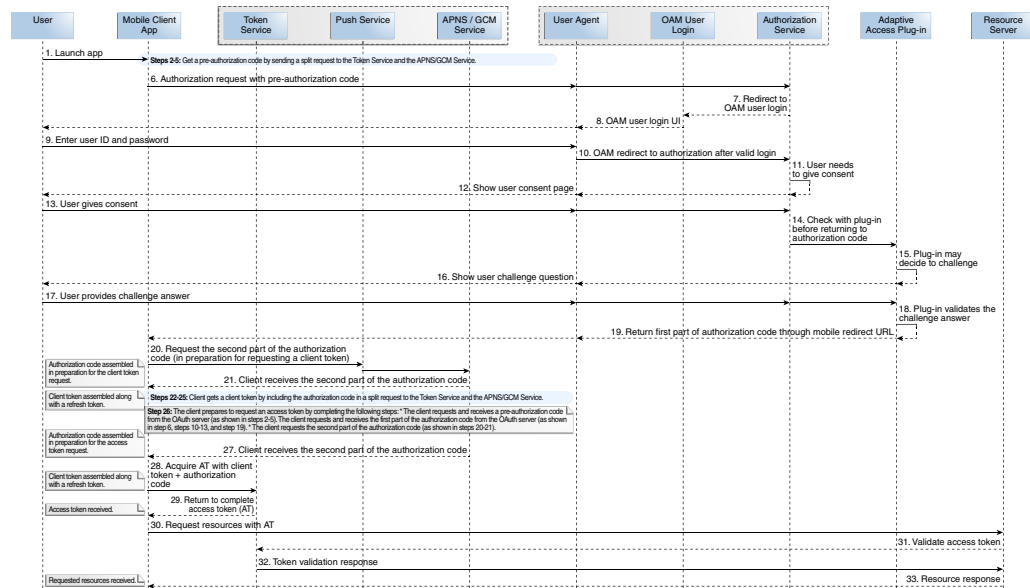
**Figure 52-3 The Complete Mobile App Authorization Request Flow**

## 52.4 Understanding the OAuth Services Components

The following sections contain information about the Identity Domains configuration options. Information in the following sections applies to both Identity Federation and Mobile Security OAuth Services except for the Jailbreak Detection Policy which is specific to Mobile Security OAuth Services. See [Configuring OAuth Services](#) for details on configuring these components.

- [Identity Domains - Identity Federation and OAuth Services](#)
- [Service Profiles - Identity Federation and OAuth Services](#)
- [Clients - Identity Federation and OAuth Services](#)
- [Service Providers - Identity Federation and OAuth Services](#)
- [Resource Servers - Identity Federation and OAuth Services](#)
- [Plug-Ins - Identity Federation and OAuth Services](#)
- [Server Settings - Identity Federation and OAuth Services](#)
- [Jailbreak Detection Policy - OAuth Services](#)
- [Token Life Cycle Management - Identity Federation and OAuth Services](#)

### 52.4.1 Identity Domains - Identity Federation and OAuth Services

Identity Domains are entities that contain all artifacts required to provide standard OAuth Services or Mobile OAuth Services.

Each Identity Domain is an independent entity. One of the primary use cases of the Identity Domain is for multi tenants deployments. Each Identity Domain will correspond to a tenant. This can apply to different departments in an organization if there is a need for independence. This will also be useful for cloud deployments where each Identity Domain can correspond to a separate tenant or entity. The following

artifacts are just some of the components configured within an OAuth Services Identity Domain.

- One or more Service Profiles
- One or more Clients
- A Service Provider
- One or more Resource Servers
- Plug-ins
- Server Settings
- Token Life Cycle Management (search for and revoke tokens across an Identity Domain)

For information on configuring Identity Domains, see [Configuring Identity Domains](#).

### 52.4.2 Service Profiles - Identity Federation and OAuth Services

You can configure a service profile that defines clients, Custom and System Resource Servers, mobile service settings, and so on.

A Service Profile defines the following settings:

- The clients with whom OAuth Services can interact
- The Custom and System Resource Servers that OAuth Services protects and to which it provides access
- Refresh token settings, token expiration settings, and the option to enable the token life-cycle management
- The User Profile Service and Consent Management Service profiles
- The enabled security profile plug-ins
- The mobile service settings, including security settings for the supported mobile platform(s)
- The root URL for the OAuth Services endpoints

You can create multiple Service Profiles, if necessary. Different Service Profiles may be needed if different clients or resources need to be grouped, or different token settings are required, or there are different service endpoints with different configuration settings. Being able to create multiple Service Profiles gives flexibility to configuration options although in most cases it may not be needed. For information on configuring Service Profiles, see [Configuring Service Profiles](#).

### 52.4.3 Clients - Identity Federation and OAuth Services

The Client initiates the OAuth protocol by invoking the OAuth Services.

Client profiles must be created using the OAuth Services interface (in the Oracle Access Management Console) before the protocol can be initiated. At a minimum, client profiles include the application name, a client ID, and one or more URIs to which OAuth Services will redirect the user-agent once access is granted or denied. An OAuth Services Client can be defined as Web, Public or Mobile.

- Web clients are assigned with a client ID and secret. These clients can interact with the OAuth Services server by sending the client ID and secret as part of an authorization header. It is up to each individual client to determine how the secret issued to them is securely stored.
- Public clients are assigned with a client ID but no secret. Typically these profiles pertain to browser based applications like Javascript or can be mobile based apps.
- Mobile clients are assigned with a client ID and the secret is dynamically generated as part of a mobile client's registration flow with OAuth Services. (The registration flow is proprietary and was developed by extending the OAuth specification.)

The client ID and secret are explained in the following bullet points.

- The Client ID is a unique string that represents the registration information and is required for each client. You can create a unique client ID or have OAuth Services generate one. OAuth Services compares the defined Client ID with the value the client sends over HTTPS or HTTP as part of an authorization request. If the values do not match, the request is rejected. Client IDs are Base64 encoded when they are sent as authorization header.
- The Client secret is the client password. You can create a unique client secret or have OAuth Services generate one. Web clients are required to have a Client ID and a Client secret. Mobile clients and Public clients, on the other hand, do not have a client secret and are given only a Client ID.

To request an access token, the client obtains authorization from the resource owner. The authorization is expressed in the form of an authorization grant, which the client uses to request the access token. The OAuth 2.0 specification provides authorization grant types for different security use cases. OAuth Services has implemented some of these grant types. Web, Public and Mobile Clients can access the various OAuth Services grant types that are appropriate to them. For example, the Client Verification Code grant type is only relevant to mobile clients. The following grant types are supported by OAuth Services.

---

---

**Note:**

(For general information about the OAuth specification grant types, see <http://tools.ietf.org/html/rfc6749#section-1.3>.)

---

---

- Authorization Code - The Resource Owner logs in using Oracle Access Management. The token endpoint exchanges the authorization code along with client credentials for an access token. The Authorization Code grant type is required for 3-legged flows.
- Resource Owner Credentials - The Resource Owner provides the client with a user name and password. This is only suitable for highly trusted client applications because the client could abuse the password, or the password could unintentionally be disclosed to an attacker. Per the OAuth 2.0 specification, the authorization server and client should minimize use of this grant type and utilize other grant types whenever possible. The Resource Owner Credentials grant type is required for 2-legged authorization scenarios.
- Client Credentials – The client requests an access token using only its client credentials (or another supported means of authentication). This is suitable if the

client is requesting access to protected resources under its control, or those of another resource owner when previously arranged with the authorization server. The Client Credentials grant type is required for 2-legged authorization scenarios.

- Refresh Token - Select this option to return a refresh token together with an access token in the token response. See [About OAuth Services Tokens](#) for more information.
- JWT Bearer - Allows a JWT assertion to be used to request an OAuth Services access token.
- SAML 2 Bearer - Allows a SAML2 assertion to be used to request an OAuth Services access token.
- OAM Credentials - Used to request OAM tokens, such as a master token, an access token, or an OAuth Services access token.
- Client Verification Code - Used by Mobile OAuth Services clients to request a pre-verification code which subsequently gets used in mobile client flows.

Privileges and Allowed Scopes can also be configured on a client by client basis. OAuth Services allows for the configuration of scopes to bypass the need for user consent. Thus, you can configure Privileges to define which clients are allowed which grant types. If applicable, the Client will then obtain an authorization grant that can be exchanged with OAuth Services for an access token. For information on configuring Clients, see [Configuring Clients](#).

#### 52.4.4 Service Providers - Identity Federation and OAuth Services

The Service Provider settings are used to manage the connection between OAuth Services and Access Manager, the back-end authorization Service Provider that supports OAuth Services. The OAuthServiceProvider is the default Service Provider for the DefaultDomain Identity Domain although a Custom Service Provider can be created.

In this release, OAuth Services provides support for both OAM authentication (most authentication modules can be invoked, usually user/credential based plugins) and IDS authentication. Any features not provided through OAM or IDS authentication will require a custom service provider. Each Identity Domain can only have one Service Provider.

---

---

**Note:**

Currently, authentication modules that have multi step orchestration in OAM can not be invoked; this refers to 2-legged OAuth Services scenarios. For 3-legged scenarios, there is no limitation on invoking OAM authentication modules because authentication is done through a browser flow.

---

---

For information on configuring Service Providers, see [Configuring the Service Provider](#).

#### 52.4.5 Resource Servers - Identity Federation and OAuth Services

Resource Servers settings are independently configured in a profile for each remote resource server that contains applications or services to be protected by OAuth Services.



The Resource Server profile does not define the resource server specific settings like the endpoint or security protection - only OAuth Services related configurations.

Part of the Resource Server configuration involves defining *scope*. Scope determines the range of access the Client will have to the protected resource. Based on the scope setting, Oracle Access Management restricts access and informs the Client of the scope in the access token issued. Thus, an OAuth Services access token with proper scope needs to be obtained in order for a Client application to access a Resource Server.

The client provides a scope string in it's request to OAuth Services. The scope can be a URL or a string literal. After successful authentication and authorization, OAuth Services includes the scope in the Access Token. For example, if an OAuth client requests access to a resource for a specific end user, OAuth Services would create an Access Token with the scope defined as `UserProfile.me` and the client could access the User Profile Resource Server with the `/me` endpoint. (See [Table 52-1](#).) In turn, the User Profile Resource Server will decide whether the client can access the resource with acquired access token or not. The following is true in regards to scope.

- A Resource Server can have one or more scope(s) associated with it.
- Multiple Resource Servers can be created if there is a need, for example, to have different token settings or to modify the default security protection (like not allowing revocation of consent). Each will have it's own set of scope definitions. This is not a common scenario
- The client sends the scope parameter as part of an authorization request. If any part of the scope parameter value is invalid, OAuth Services sends the client application an `invalid_scope` error response. If the scope parameter value is valid, it gets embedded as part of the authorization code and access tokens.

OAuth Services provides two out-of-the-box services modeled as Resource Servers and protected with an Access Token. For information on the User Profile Services and Consent Management Services Resource Servers, see the following sections.

- [User Profile Services](#)
- [Consent Management Services](#)

For configuration information, see [Configuring Custom Resource Servers](#), [Configuring User Profile Services](#), and [Configuring Consent Management Services](#).

#### 52.4.5.1 User Profile Services

The default **UserProfile** User Profile Services configuration is a Resource Server created during Oracle Access Management OAuth Services installation.

This configuration allows your organization to use OAuth 2.0 to interact with a back-end LDAP directory server and perform the REST operations documented in [Table 52-1](#) on Person, Group, and Relationship entities. See the *Oracle Fusion Middleware Developer's Guide for Oracle Access Management* for more details on using REST to interact with the User Profile Services.

**Table 52-1 Default User Profile Services Endpoint Operations**

Resource Endpoint (URI)	HTTP(S) Methods	Use Details
<code>http://host:port/ms_oauth/resources/userprofile/me</code>	GET allows read PUT allows update	The OAuth client can request <i>read</i> and <i>update</i> privileges for the specified user's profile.

**Table 52-1 (Cont.) Default User Profile Services Endpoint Operations**

Resource Endpoint (URI)	HTTP(S) Methods	Use Details
<code>http://host:port/ms_oauth/resources/userprofile/users</code>	GET allows read, search POST allows create PUT allows update DELETE allows delete	The OAuth client can request <i>create, read, search, update, and delete</i> privileges for any user profile.
<code>http://host:port/ms_oauth/resources/userprofile/groups</code>	GET allows read, search POST allows create PUT allows update DELETE allows delete	The OAuth client can request <i>create, read, search, update, and delete</i> privileges for any group profile.
<code>http://host:port/ms_oauth/resources/userprofile/secretkey</code>	GET allows read POST allows create DELETE allows delete	Used by Oracle Mobile Authenticator to read, create or delete secret key for given user. The secret key is used by OMA to generate a one time pin.

User Profile Services receives and responds to HTTPS requests using the service-specific endpoints for Person, Group, and Relationship entities. Each service endpoint can be individually disabled if it is not needed. If there are users across multiple user repositories, you can create multiple instances of User Profile Services; for example, if a company uses different repositories for different organizations this would be useful. Creating multiple user profile services may not be common though. See [Introducing User Profile Services](#) for more information. For information on configuring User Profile Services, see [Configuring User Profile Services](#). The following sections contain details on specific User Profile Services configurations.

- [Proxy Authentication](#)
- [Securing User Profile Services Activity](#)
- [Entity Relationship](#)

#### 52.4.5.1.1 Proxy Authentication

Proxy authentication allows a user to control the security of middle tier applications by preserving client identities and privileges through all tiers, and auditing actions taken on behalf of clients.

For example, this feature allows the identity of a user using a web application (also known as a "proxy") to be passed through the application to the database server. Oracle Unified Directory (OUD) and Active Directory (AD) are few directory servers that support proxy authentication. Proxy authentication delivers the following security benefits.

- A limited trust model, by controlling the users on whose behalf middle tiers can connect, and the roles the middle tiers can assume for the user.
- Accountability, by preserving the identity of the real user through to the database, and enabling auditing of actions taken on behalf of the real user.

- Flexibility, by supporting environments in which users are known to the database, and in which users are merely "application users" of which the database has no awareness.

Oracle Access Management provides the ability to add proxy authentication features on top of directory servers that do not support it. The Access Control option is simply Proxy Authentication support for directory servers that do not have built in support for proxy authentication.

Proxy Authentication and Access Control were previously available in Mobile Services and now this support is available in OAuth Services. Without Proxy Authentication or Access Control enabled, communication with directory servers is done using the administrator user account; in this case, the administrator can perform any operations on any user. By enabling this feature, the logged in user can only perform operations for which privilege has been granted.

#### 52.4.5.1.2 Securing User Profile Services Activity

Security considerations are very important when implementing User Profile Services.

For example, a user with write access to UserProfile.me can change their own UID or mail address causing a serious breach. Because of this it is possible to limit the scope of all URI to read only and you should be careful about granting write access to any scope. You can also configure read and write access independently on a per-attribute basis.

Security protection is defined within the Scopes table of the configured User Profile Service. Adding a URI allows you to select whether the service endpoint is enabled, whether read or write access is allowed, whether the URI is protected by an access token, and whether user consent is required.

The Oracle Access Management Console also allows fine-grained configuration of the attributes that can be modified. You can also add custom attributes or remove default attributes. [Table 52-2](#) documents the out-of-the box configurable attributes for each scope setting.

**Table 52-2 User Profile Resource Server - Scope Settings**

Scope	HTTP(S) Method	Resource URI	Attributes
UserProfile.me	GET PUT	/me	uid, mail, description, commonname, firstname, lastname
UserProfile.users	GET POST PUT DELETE	/users	uid, mail, description, commonname, firstname, lastname
UserProfile.groups	GET POST PUT DELETE	/groups	name, description

**Table 52-2 (Cont.) User Profile Resource Server - Scope Settings**

Scope	HTTP(S) Method	Resource URI	Attributes
UserProfile.secretkey.management	GET POST DELETE	/secretkey	There are no attributes needed.

#### 52.4.5.1.3 Entity Relationship

An entity relationship is an association between two entities such as Users and Groups.

The entity types can be the same or different. For example, the memberOf entity is a relationship between a user and a group while the manager entity is a relationship between two users. Client applications can create, read or delete relationships using the User Profile Services relationship endpoint. The following REST operations illustrate how to create a memberOf relationship. In these examples, the relationship endpoint is memberOf, the source entity URI is user-uri and the destination-entity URI is group-uri.

Create User "John"

```
curl -H "Content-Type: application/json" --request POST http://localhost:port/ms_oauth/resources/userprofile/users -d '{"uid":"John"Anderson","commonname":"John Anderson","firstname":"John"}'
```

Create Group "Group1"

```
curl -H "Content-Type: application/json" --request POST http://localhost:port/ms_oauth/resources/userprofile/groups -d '{"description":"group1 testing","commonname":"group1"}'
```

Create memberOf relationship

```
curl -H "Content-Type: application/json" --request POST http://localhost:port/ms_oauth/resources/userprofile/users/memberOf -d '{"group-uri":"\idaas_rest\rest\userprofile\group\group1", "user-uri":"\idaas_rest\rest\userprofile\people\John"}'
```

#### 52.4.5.2 Consent Management Services

The default Consent Management Services configuration is labeled **ConsentManagement** and handles consent storage, retrieval, revocation, and consent validation operations. If you select the **Require User Consent** option Oracle Access Management displays to the user a consent form so that access to the requested resource can be approved or denied by the user. The Require User Consent option can be enabled on a scope by scope basis. For example, you can require user consent for a scope request that allows "write" access but not "read" access. Consent data is stored in the Oracle Access Management database. For information on configuring Consent Management Services, see [Configuring Consent Management Services](#).

---

---

**Note:**

The Clients configuration page has a **Bypass User Consent** option. If this option is selected, the Client setting overrides the Resource Server setting. For information on configuring Clients, see [Configuring Clients](#).

---

---

Any consent operation requires an access token of the Client Credentials grant type (as discussed in [Clients - Identity Federation and OAuth Services](#)) and the desired Consent Management scope. A user (through the client) requests access to a resource protected by OAuth Services. The request contains an access token, the client identifier and the user identifier. OAuth Services retrieves the configured scopes and, if allowed, grants consent by adding the scope to the access token. The access token is added to the authorization header in the HTTP request which is used to retrieve, grant or revoke consent using the endpoints provided by the Consent Management Service. For details on using REST interfaces to interact with Consent Management Services, see *Oracle Fusion Middleware Developer's Guide for Oracle Access Management*.

---

---

**Note:**

Multiple Consent Management Services are not necessary.

---

---

## 52.4.6 Plug-Ins - Identity Federation and OAuth Services

Plug-ins enhance security by consulting additional logic for trust and risk analysis. (Such additional logic may deny certain risky operations.) Plug-ins apply the logic during authentication operations, including client application registration for mobile apps.

The following plug-in types are available for use with OAuth Services and Mobile OAuth Services.

- The *Custom Token Attributes Plug-in* defines security policy around the token service provider.
- The *Authorization and Consent Service Plug-in* defines security policy around interactions where authorization and user consent are granted. This plug-in type can influence claims in a generated token as well.
- The *Client Plug-in* defines a security policy for Clients in an Identity Domain.
- The *Resource Server Profile Plug-in* defines a security policy for Resource Servers in an Identity Domain.

The following plug-in types are available for use with Mobile OAuth Services only:

- The *Mobile Security Manager Plug-in* is for use with Oracle Mobile Security Suite (OMSS). The Mobile Security Manager (MSM) component (part of OMSS) collects a rich set of mobile device data. This plug-in gathers that information and also invokes the MSM compliance policy, which checks the compliance status of the device. Finally, the plug-in sends the device information and the compliance status to the Adaptive Access Plug-in. For information about configuring the Mobile Security Manager plug-in, see [Plug-in Configuration Page](#).
- The *Adaptive Access Plug-in* is for use with Oracle Adaptive Access Manager (OAAM). It runs fraud detection and risk analysis policy checks that further

validates that the user connection is authentic and can be trusted. The Adaptive Access Plug-in can utilize mobile device attribute values collected by the Mobile Security Manager Plug-in, or, if Oracle Mobile Security Suite is not available, the Adaptive Access plug-in can use mobile device attribute values that the Mobile OAuth Services obtains during mobile app requests. If the Mobile Security Manager Plug-in is active, it runs first and passes device data to the Adaptive Access Plug-in, which runs second.

For more information, see [OAuth Services Plug-ins](#).

For each plug-in type only one instance can be active at a time at the service profile level. For example, you can create and save different instances of the Client Plug-in at the Identity Domain level, but at the Service Profile level you can only assign one Client Plug-in instance at a time. Optional plug-ins can be configured to provide additional security. For information on configuring plug-ins, see [Configuring Plug-Ins](#).

### 52.4.7 Server Settings - Identity Federation and OAuth Services

The Server Settings page is for configuring general server settings for the Identity Domain under which it is accessed.

For information on configuring Server Settings, see [Server Settings](#).

### 52.4.8 Jailbreak Detection Policy - OAuth Services

A preconfigured Jailbreaking Detection Policy for iOS devices can search for files that indicate a device is jail broken and, if found, deny that device access to OAuth Services.

This setting tab is displayed and for use with Mobile OAuth Services only. For information on configuring the Jailbreak Detection Policy, see [Jailbreak Detection Policy](#).

### 52.4.9 Token Life Cycle Management - Identity Federation and OAuth Services

You can search for tokens using criteria such as user ID, client ID/name, client IP address, service profile, assertion token category, and token creation/expiration time. Using the Token Life Cycle Management page, you can revoke a token that have been issued.

For information on configuring Token Life Cycle Management, see [Token Life Cycle Management](#).

## 52.5 About OAuth Services Tokens

OAuth Services generates a Client Token, a User Token and an Access Token.

The Client Token is generated by OAuth Services when using the Client Credentials grant type without any scope for confidential clients, or for mobile clients. The User Token is generated by OAuth Services using the User Credentials grant type without any scope. The Access Token is generated with supported grant types using scope parameters. See [Clients - Identity Federation and OAuth Services](#) for details on grant types.

---

**Note:**

A user and client can provide credentials in the form of a JWT token or an assertion for verification and generation of one of the three tokens. It is possible to use a Client Token or a User Token generated by OAuth Services as a Client Assertion or a User Assertion respectively but that is not common.

---

The Refresh Token is also generated by OAuth Services. It is issued when an offline scope is presented in the Access Token request and usually has a higher expiration time than the Access Token. A Refresh token can be used to get an Access Token. The following sections contain additional details.

- [OAuth Services Access Tokens](#)
- [OAuth Services Refresh Tokens](#)
- [Mobile OAuth Services Client Tokens](#)

### 52.5.1 OAuth Services Access Tokens

If OAuth Services determines that a user must consent to the request for access to a protected resource, a consent form is displayed. After the user consents, OAuth Services returns an authorization code to the Client service provider. The Client then sends the authorization code to the Token Endpoint and requests an OAuth Services Access Token. (When making the request, the Client authenticates with OAuth Services.) If received, the Access Token allows access to the protected resources. See [Understanding the Authorization and Authentication Endpoints](#) for details on the Token Endpoint.

Oracle Access Management can embed custom attributes in Access Tokens. Custom attributes are configured as part of the Service Profile or the Custom Resource Server. They are defined as static or dynamic.

- **Static Attributes** - Attribute name and value pairs where the value is fixed at the time that you define the attribute. For example, `name1=value1`.
- **Dynamic Attributes** - User-profile specific attributes. You must also configure the **User Store** setting on the Service Profile Configuration page. This setting defines the source of the User Profile attributes. The User Profile Service (and/or the underlying IDS interface) may be used to retrieve attribute names and values. Because dynamic attributes are user related, the user consent page (if configured) shows that the configured attributes are being shared with clients and resources.

[Configuring Service Profiles](#) and [Configuring Service Profiles](#) contain more information. Keep the following guidelines in mind when configuring custom attributes:

- Do not use the same name for a static and dynamic attribute.
- Avoid using the same name when adding custom attributes to the service profile configuration and the scope configuration. If you define the same attribute name in both locations, the scope-based attribute value takes precedence.

Custom attributes appear as claims in access tokens. JWT-based access tokens contain standard JWT claims along with OAuth Services specific ones. For example:

- Standard

```
"exp":1357596398000,
"iat":1357589198000,
"aud":"oam_server1",
"iss":"OAuthServiceProfile",
"prn":null,
"jti":"340c8324-e49f-43cb-ba95-837eb419e068",
```

- OAuth Services Specific

```
"oracle.oauth.user_origin_id":"john101",
"oracle.oauth.user_origin_id_type":"LDAP_UID",
"oracle:idm:claims:client:macaddress":"1C:AB:A7:A5:F0:DC",
"oracle.oauth.scope":"brokerage",
"oracle.oauth.client_origin_id":"oauthssoapplid",
"oracle.oauth.grant_type":"oracle-idm:/oauth/grant-type/resource-access-token/
jwt"
```

These claims are available as part of the access token generated by OAuth Services. Because the custom attributes appear as claims in a JWT-based access token, the following naming restrictions apply:

- Avoid JWT standard claim names.
- Avoid names with an "Oracle" prefix (as shown above)

## 52.5.2 OAuth Services Refresh Tokens

OAuth Services can be configured to allow the Client to use a refresh token to obtain additional access tokens with identical or narrower scope.

The refresh token is used when the access token is no longer valid. The purpose of a refresh token is to improve security. Access tokens are short-lived, so if stolen, they are only useful for a limited period. Refresh tokens are longer-lived, but are less frequently sent to the server, thus reducing the likelihood that they will be stolen.

Any scope can request and use a refresh token, however, the refresh token is typically used when the user is offline. When configuring a Resource Server, the administrator can designate one scope to be the offline scope. If an access token request includes the scope designated as the offline scope, the server will include the refresh token with the access token. If the offline scope field is not configured, the server will not issue a refresh token. See [Custom Resource Servers Configuration Page](#) for details.

The client must be configured to use the refresh token. See [Service Profile Configuration Page](#) and [Web Clients Configuration Page](#) for information about refresh token settings.

## 52.5.3 Mobile OAuth Services Client Tokens

Mobile applications must register with Oracle Access Management prior to using OAuth Services and each registration is specific to one app on the device.

After the application registration, the mobile app will have a Client Token. It uses this token as the security credential for making Access Token requests. See [Understanding Mobile OAuth Services Server-Side Single Sign-on](#) for details.

## 52.6 Understanding the Authorization and Authentication Endpoints

OAuth Services has four authentication endpoints that receive and respond to HTTPS requests: *the authorization endpoint*, *the token endpoint*, *the push endpoint*, and *the user consent revocation endpoint*. Each endpoint is a URL that clients use to make requests.



The authentication endpoints are:

- **Authorization Endpoint** – The client uses the Authorization Endpoint to get authorization from the resource owner to access the requested resources. The client application initiates the Authorization Endpoint request by sending its identifier, a requested scope defining the resource to which it wants access, and a redirection URI to which OAuth Services will direct the web browser once access is granted or denied. This endpoint accepts the HTTPS request. The URI for this endpoint always ends in *authorize*. For example:

```
http(s)://<host>:<port>/ms_oauth/oauth2/endpoints/
<yourOAuthServiceName>/authorize
```

- **Token Endpoint** – The client application interacts with the Token Endpoint to exchange an authorization code grant for an access token. It is also used for Client Credentials grant type and resource owner credentials grant type to get an access token. The client uses a Refresh token to obtain a new access token. The URI for this endpoint always ends in *token*. For example:

```
http(s)://<host>:<port>/ms_oauth/oauth2/endpoints/
<yourOAuthServiceName>/token
```

- **Push Endpoint** – Mobile OAuth Services client apps interact with the push endpoint to obtain (depending on configuration) part of the authorization codes, and/or part of the client tokens, access tokens, and refresh tokens that are sent through either the Apple Push Notification Service (APNS) or the Google Cloud Messaging (GCM) service. It can also be used for Mobile Client Verification code, Authorization Code and Client Tokens. For example, the end point for requesting data from APNS is:

```
http(s)://<host>:<port>/ms_oauth/oauth2/endpoints/oauthservice/push
```

- **User Consent Revocation Endpoint** - Resource owners (end-users), who authenticate and authorize client applications using the browser-based authorization endpoint flow, use this endpoint to revoke their consent to client applications. For example:

```
http(s)://<host>:<port>/ms_oauth/oauth2/ui/
<yourOAuthServiceName>/showrevokeconsent
```

When configuring clients with authorization code grant in the OAuth server, you also need to provide at least one client redirect URI where the server can return authorization credentials to the client.

- **Client Redirect URIs** – The OAuth Services server returns authorization credentials to the client using the URI specified in the request provided that it exactly matches a URI configured in the client profile.

## 52.7 Enforcing Access Control

Typically, an OAuth Services client application makes REST calls to services deployed on remote servers. These calls, carrying an access token, need to be validated before the call can go through. Enforcing access control is accomplished by sending a previously obtained access token to a resource server defined in OAuth Services.

Exceptions to this are the native User Profile and Consent Management Services that are enforced by OAuth Services. The options for validation within the Oracle stack are Oracle API Gateway (OAG) and Oracle Web Services Manager. (An OAG filter

validates the Oracle Access Management OAuth Services token before allowing access to the resource.) Custom code can also be written to provide access control.

---

**Note:**

WebGates do not support validating access tokens.

---

## 52.8 Understanding Mobile OAuth Services Server-Side Single Sign-on

The server-side single sign-on (SSO) feature allows multiple mobile apps on a device to share a single user session that resides on the OAM server and not with the client.

This feature saves JWT and OAM user tokens in the Server-Side Device Store, and maintains the user session in the browser with cookies. Thus, the server session is not tied to the client. Session time-out values are configurable at the Service Profile level for the client token, user token, and access token. The access token time-out value can also be overridden at the Resource Server level.

Keeping sensitive session info on the server (and not on the device) reduces the risk of the tokens being copied if the device or client app is compromised. For 2-legged flows, if server-side single sign-on is turned off (it is on by default), the user token is not stored on the server but sent to the client on the mobile device. You can enable and disable this feature using the Mobile OAuth Services Service Profile configuration page. For 3-legged flows, server-side single sign-on is always automatically enabled.

- [Understanding the Server-Side Single Sign-On Credential Collection Options](#)
- [Understanding Server-Side SSO For Mobile OAuth Services 3-Legged Flows](#)
- [Understanding Server-Side SSO For Mobile OAuth Services 2-Legged Flows](#)

### 52.8.1 Understanding the Server-Side Single Sign-On Credential Collection Options

Developers in your organization can implement single sign-on in a client app by using an external browser, an embedded browser, or by using a native app registered with Mobile and Social Services as an SSO proxy.

This section briefly discusses the different approaches.

- [External Browser Approach](#)
- [Embedded Browser Approach](#)
- [Native App Proxy Approach](#)

#### 52.8.1.1 External Browser Approach

The mobile app switches to an external browser, which executes the logic for user authentication and user consent management.

A shared browser cookie maintains the user session and can be used to provide SSO across multiple apps. The external browser uses a typical Web SSO mechanism that supports OAM user authentication, JWT user authentication, third-party user authentication, and social authentication (using the Social Identity service). One drawback to using an external browser is the screen "flickering" that occurs when the application context switches between the browser and the application.

### 52.8.1.2 Embedded Browser Approach

The mobile app uses its own embedded browser. Because the browser cookie cannot be shared across multiple apps, OAM and third-party user authentication cannot be used.

Instead, Mobile OAuth Services uses a JWT user session token stored in the Server-Side Device Store. When additional apps are launched, SSO is established using device identification together with the shared JWT user session token. The embedded browser approach eliminates the screen “flickering” that occurs when the application context switches between the application and the external browser (as discussed in [External Browser Approach](#)).

### 52.8.1.3 Native App Proxy Approach

If a native app is already installed on the device, it can facilitate SSO by serving as a proxy between the browser-based app and the Mobile OAuth Services SSO Servlet on the OAM server.

As needed, the Servlet registers the device and app with OAM and obtains the tokens required to authenticate the app in the browser so that it can access the OAM-protected resource. To use this approach, native apps must use Mobile and Social Services to authenticate with Access Manager. This approach can be used for 2-legged flows.

## 52.8.2 Understanding Server-Side SSO For Mobile OAuth Services 3-Legged Flows

Server-side SSO is always enabled for Mobile OAuth Services 3-legged scenarios. The Mobile OAuth Services server executes the logic for user authentication and user consent management, collects the user credentials, and provides the required SSO functionality.

Users log in once and gain access to all systems without being prompted to log in again. For JWT, third-party, and social authentication, the OAM server stores the user token in the Device Store, whereas OAM authentication stores the OAM\_ID (representing an OAM session) in the Device Store. When the user token or OAM\_ID expires, the user is prompted to log in again.

When implementing mobile 3-legged scenarios, enable the **Authorization Code** grant type by going to the Mobile OAuth Services Clients configuration page in the Oracle Access Management Console. Apps should implement the mobile 3-legged flows documented in the *Oracle Fusion Middleware Developer’s Guide for Oracle Access Management*.

Apps that use a Mobile OAuth Services 3-legged scenario should collect credentials using a mobile browser (as discussed in [Understanding the Server-Side Single Sign-On Credential Collection Options](#)). To specify an authentication type using the Oracle Access Management Console, open the Mobile OAuth Services Service Profile configuration page and under **Mobile Service Settings**, choose an option for **Consent Service Protection**. The following sections describe these options.

### OAM Authentication or Third-Party Access Management

If using OAM authentication or Third-Party Access Management, Access Manager (or a third-party access management product) is responsible for user authentication. Any OAM authentication method that supports login through the browser is an option. Because Access Manager supports SSO using an OAM\_ID cookie, this flow must use an external browser (as discussed in [External Browser Approach](#)). Following authentication, the user token is stored in the Server-Side Device Store.

Oracle Access Management supports session synchronization so that 2-legged flows can get OAM tokens later. For example, the first app registers with the server using the 3-legged flow. Next, a second app completes the 2-legged registration using the existing session established by the first app. Thus a 3-legged flow session can register additional apps using a 2-legged flow by using the same session created during the first app registration.

### **JWT Authentication**

JWT authentication is an authentication mechanism provided by Mobile and Social for mobile applications. In this case, Mobile and Social hosts the user interface for user login. It accepts a user name and password for authentication, using the configured user store for user authentication. The user store can be configured in Mobile and Social or in Oracle Access Management. It is configured using the User Authenticator under User Store in OAuth Services profile.

As discussed previously, JWT user authentication is the only authentication type that supports single sign-on using an embedded browser. (If the ability to use multiple apps on the same mobile device is not a requirement, then either OAM authentication or third-party authentication is sufficient.) JWT authentication can also be used with external browsers, but the application will need to switch from the app to the browser and back again when Mobile and Social checks the user token in the Device Store for single sign-on.

### **Social Authentication**

Social authentication allows app users to authenticate using social identity providers such as Facebook and Twitter. This type of authentication requires the Oracle Access Management Social Identity service (part of Mobile and Social). If using social authentication, the Oracle Access Management server redirects the user to the social identity provider for authentication. For single sign-on, an external browser is required. Following authentication, the user token is stored in the Server-Side Device Store. Social Authentication is supported for 3-legged flows only.

## **52.8.3 Understanding Server-Side SSO For Mobile OAuth Services 2-Legged Flows**

Apps that use Mobile OAuth Services 2-legged scenarios should collect user credentials using the native iOS or Android user interface although you are limited to username/password-based OAM authentication or IDS (directory server).

By switching to an external browser, you can use the usual supported authentication schemes, including OAM user authentication, third-party authentication, and JWT user authentication.

Unlike with mobile 3-legged scenarios, you can choose to disable the server-side single sign-on feature with mobile 2-legged scenarios. To disable it, open the Mobile OAuth Services Service Profile Configuration page and clear the **Enable Server-Side Single Sign-On** option. (Server-Side SSO can also be set using WLST.)

- If Server-Side SSO is enabled, the server collects user credentials on behalf of the client and provides SSO. Additional apps (that is, apps that share the same device profile) have to register with the server the first time they are launched. You can require the user to authenticate every time an app is registered, or you can allow the registration to happen automatically in the background without involving the user. Configure the `msAlwaysShowLogin` attribute on the Service Profile page to select the desired behavior.

- If the `msAlwaysShowLogin` Service Profile attribute is set to `true`, the user has to enter a user name and password in the native app to register the app and get a client token.
- If the attribute is set to `false`, the server automatically registers apps using the server-side user token.

Once registered, subsequent access requests from apps on the device typically result in the server providing a client token and allowing access. (In some cases the user may not get access right away—for example, if Oracle Adaptive Access Manager rules are active.)

- If Server-Side SSO is disabled, *the client* collects the user credentials and must also provide SSO. On a first access attempt the user enters a user name and password in the native app to register the device. The server returns a user token that the device stores locally. Subsequent access requests from apps on the device must use the stored user token to register the apps and gain access.

For mobile 2-legged scenarios, enable the **Resource Owner** grant type by going to the Mobile OAuth Services Clients configuration page in the Mobile Oracle Access Management Console. Apps should implement the mobile 2-legged flows documented in the *Oracle Fusion Middleware Developer's Guide for Oracle Access Management*. The following sections give an overview of SSO options.

- [OAuth Mobile SSO Servlet Authentication](#)
- [Using SSO Between Native Apps and an External Browser](#)

### 52.8.3.1 OAuth Mobile SSO Servlet Authentication

If a user using a mobile browser (external or embedded) needs to access a protected Web resource, and there is a native app that uses Mobile and Social Services to authenticate with OAM already installed on the device, the native app can register the device on behalf of the Web app and gain access to the resource without requiring the user to sign on.

This single sign-on approach utilizes the OAuth Mobile SSO Servlet that was added to the OAM server in release 11.1.2.3. For configuration steps, see [Configuring Mobile OAuth for SSO Servlet Authentication](#).

### 52.8.3.2 Using SSO Between Native Apps and an External Browser

Another alternative utilizing a native app and an app running in an external browser is to implement 2-legged flows in the native app using the OAuth Services REST API.

Server-side SSO can be enabled or disabled. The native app registers the device and user, and exchanges an OAM token to get an OAM\_ID cookie (which is the OAM master token). The native app can then launch the external browser and inject the OAM\_ID cookie so that users accessing WebGate-protected resources with an external browser will not be prompted to log in every time. For information about implementing the 2-legged flows, see the *Oracle Fusion Middleware Developer's Guide for Oracle Access Management*.

## 52.9 OAuth Services Plug-ins

Oracle Adaptive Access Manager (OAAM) is an optional product that can screen Mobile OAuth Services transactions using a provided security plug-in.

Together, OAAM and the plug-in provide mobile-client fraud detection, knowledge-based authentication (for two-factor authentication after user name and password

authentication), and one time password functionality. If the Oracle Mobile Security Suite is deployed, the Mobile Security Manager plug-in gathers additional mobile device data for OAAM to screen.

To use OAAM with Mobile OAuth Services, the Adaptive Access security plug-in must be installed. This plug-in can add value during app registration when client tokens or user tokens are being validated or refreshed, and during token exchange.

OAAM rules and policies are defined in Oracle Adaptive Access Manager. The following is a brief description of the OAAM and Adaptive Access Plug-in features.

- The Adaptive Access Plug-in enhances security by screening mobile app registration requests for both 2-legged and 3-legged flows. The plug-in runs fraud detection and risk analysis policy checks.
- Knowledge-based authentication (KBA) and one time password authentication (OTA) can also be integrated into the mobile app registration process. The OAuth Service REST API flows include sample challenge requests and responses that a developer will need to implement in your app(s).
- Following registration, the Adaptive Access Plug-in screens user tokens for security violations instead of simply checking if the user token is valid. The result of this screening is either *allowed* or *denied*.

Using the Mobile Security Manager Plug-in Together With the Adaptive Access Plug-in

The Mobile Security Manager Plug-in is for use with Oracle Mobile Security Suite (OMSS). The Mobile Security Manager (MSM) component (part of OMSS) collects a rich set of mobile device data and passes it to the Adaptive Access Plug-in for use by OAAM. If Oracle Mobile Security Suite is not available, the Adaptive Access plug-in uses mobile device attribute values that the Mobile OAuth Services server obtains during mobile app requests.

---



---

**Note:**

The Mobile Security Manager plug-in requires special configuration before it can be used. See [Configuring the Mobile Security Manager Plug-in](#) for details.

---



---

If the Mobile Security Manager Plug-in is active, it runs first and sends its data to the Adaptive Access Plug-in, which runs second. The Adaptive Access Plug-in checks the results of the MSM compliance policy that reports the compliance status of the device. If the compliance policy response is negative, the Adaptive Access Plug-in denies the mobile app request; If the response is positive, the Adaptive Access Plug-in passes the device data to Oracle Adaptive Access Manager for stronger authentication checks and risk evaluation. The Mobile Security Manager plug-in gets device info and checks the MSM compliance policy in the following cases:

- During the app registration flow following user authentication.
- As part of the client token and user token validation process.

For more information:

- See "[Understanding OAuth Services Authorization for Mobile Clients](#)" for a detailed look at when in the Mobile OAuth Services flow OAAM interacts with mobile apps.

- See [Plug-Ins - Identity Federation and OAuth Services](#) for summary information about the various OAuth Services plug-ins.
- See [Configuring Plug-Ins](#) for information about configuring the adaptive-access plug-in.





---

## Configuring OAuth Services

Oracle Access Management provides a graphical user interface for configuring OAuth Services. The configuration options are available within the Identity Federation or Mobile Services interfaces depending on the licensing procured.

This chapter describes how to use the Oracle Access Management Console to enable OAuth Services and configure the OAuth Services components.

- [Enabling OAuth Services](#)
- [Configuring OAuth Services Components in an Identity Domain](#)
- [Configuring OAuth Services Settings](#)
- [Configuring OAuth Services for Third-Party JWT Bearer Assertions](#)
- [Configuring a WebGate to Protect OAuth Services](#)
- [Configuring OAM Session Synchronization](#)
- [Configuring Mobile OAuth for SSO Servlet Authentication](#)
- [Configuring the Mobile Security Manager Plug-in](#)

---

**Note:**

OAuth Services can be configured from the command line using WLST. For more information about the Mobile and Social WLST commands, see the *Oracle Fusion Middleware WebLogic Scripting Tool Command Reference*.

---

### 53.1 Enabling OAuth Services

Oracle Access Management OAuth Services has to be explicitly enabled in order to use it.

A license for Oracle Access Management Identity Federation (if using web clients only) or Mobile and Social (if using web and mobile clients) is required to enable it. Once correct licensing is procured, enable Identity Federation or Mobile and Social by clicking Available Services in the Configuration Launch Pad of the Oracle Access Management Console. These section links contain more details.

- [Understanding the Oracle Access Management Console](#)
- [Available Services of the Common Configuration Section](#)
- [Enabling Identity Federation](#)
- [Enabling Mobile and Social](#)

## 53.2 Configuring OAuth Services Components in an Identity Domain

To use Oracle Access Management OAuth Services, you will need to configure an Identity Domain. OAuth Services ships with a default Identity Domain named **DefaultDomain**.

You can create additional domains as needed. Each OAuth Services Identity Domain has a universally unique identifier (UUID) that specifically identifies it on the Internet.

Access to the Identity Domain configuration page is dependent on whether you have enabled Identity Federation OAuth Services or Mobile and Social OAuth Services. [Figure 53-1](#) contains two screenshots: the top displays the Mobile OAuth Identity Domains and the bottom displays the Federation (web only) OAuth Identity Domains. Note that both contain the DefaultDomain. To access the appropriate page, do the following.

- Click **Mobile Security** at the top of the Oracle Access Management Console and then click Mobile OAuth Services.
- Click **Federation** at the top of the Oracle Access Management Console and then click OAuth Services.

**Figure 53-1 Mobile (top) and Federation (bottom) Identity Domain Screens**

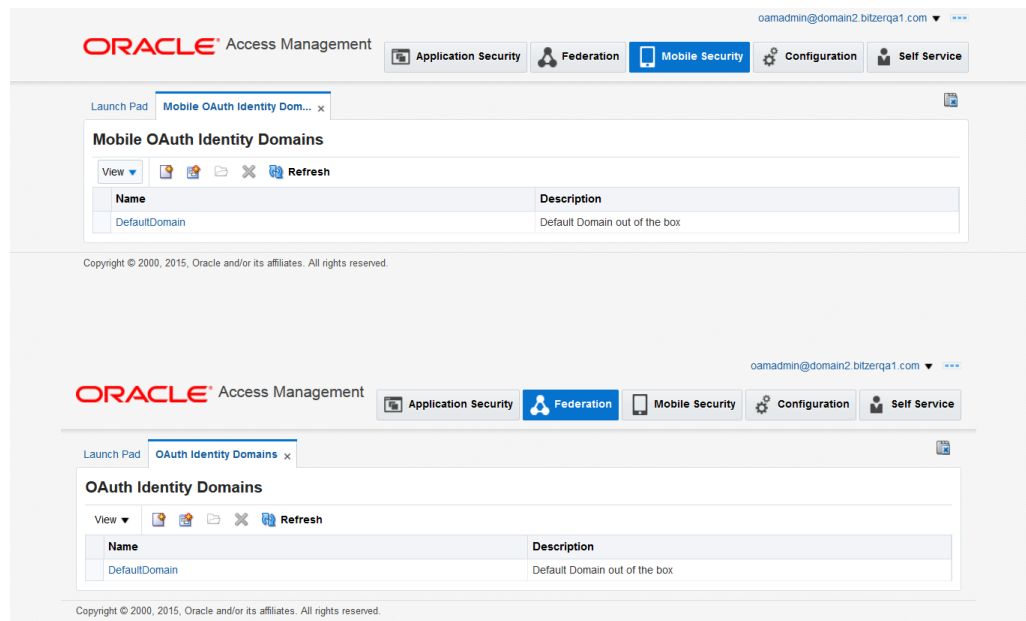

[Figure 53-2](#) is a screenshot of the Identity Federation OAuth Services DefaultDomain configuration page. To access this page, click DefaultDomain (or any custom domain that might have been created) from the Identity Federation Identity Domain configuration page. (If OAuth Services is accessed by clicking a Mobile Security configured domain, a third OAuth Mobile Clients table is also displayed on the Clients tab of the selected domain.)

**Figure 53-2 Identity Federation DefaultDomain Configuration Page**

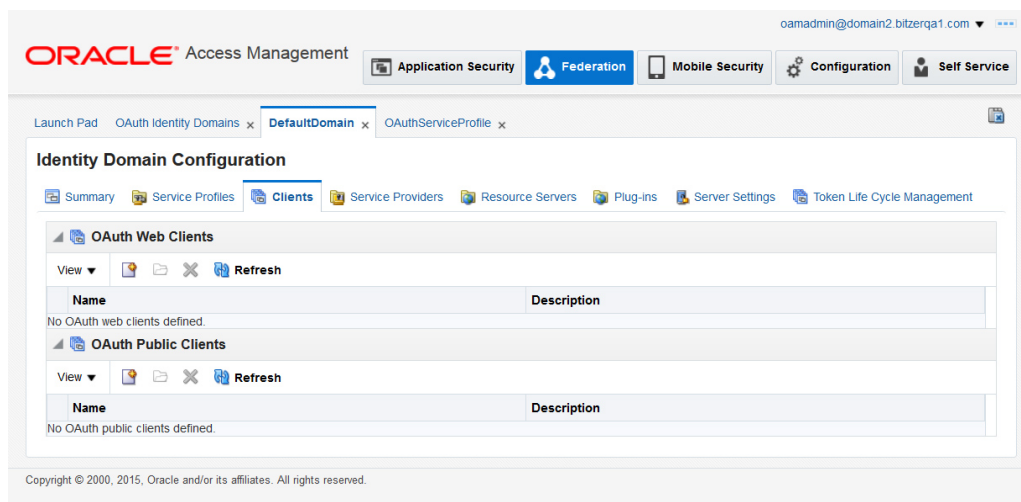

When accessing the Identity Domain configuration page through Mobile Security, the Jailbreak Detection Policy tab is included with those previously listed for Identity Federation. Figure 53-3 is a screenshot of the Mobile Security OAuth Services DefaultDomain configuration page with the Jailbreak Detection Policy page displayed. To access this page, click DefaultDomain (or any custom domain that might've been created) from the Mobile Security Identity Domain configuration page.

**Figure 53-3 Mobile Security DefaultDomain Configuration Page**

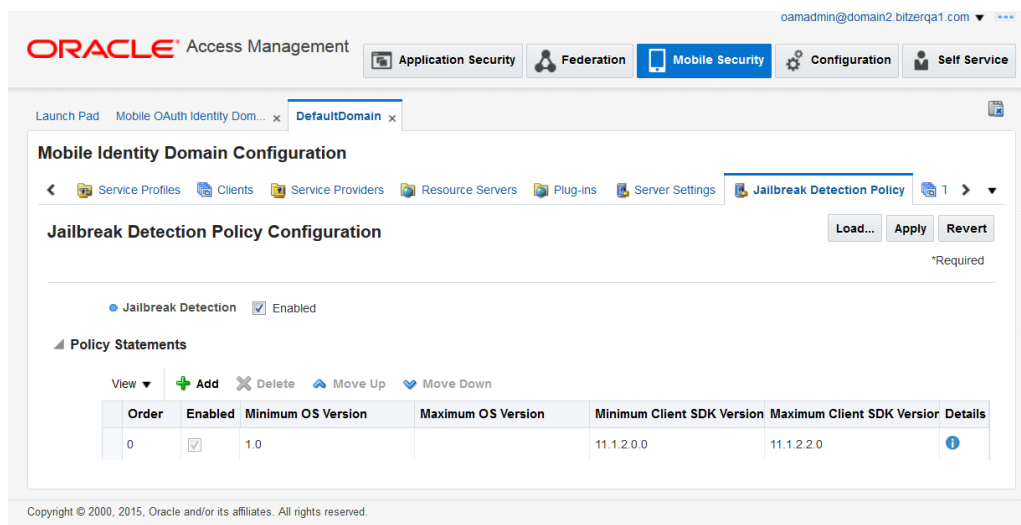

The Identity Domains pages list all configured OAuth Services Identity Domains. When the list is displayed, you can create a new Identity Domain by clicking Create Using Single Step or Create Using Wizard Flow. Click a domain name to modify an already configured profile.

### 53.3 Configuring OAuth Services Settings

OAuth Services has many components that must be configured before the authorization protocol can be used.

Descriptions of the OAuth Services components and how they work together can be found in [Understanding the OAuth Services Components](#). This section includes

information on configuring the OAuth Services components using the Oracle Access Management Console only. It contains the following topics:

- [Configuring Identity Domains](#)
- [Configuring Service Profiles](#)
- [Configuring Clients](#)
- [Configuring the Service Provider](#)
- [Configuring Custom Resource Servers](#)
- [Configuring User Profile Services](#)
- [Configuring Consent Management Services](#)
- [Configuring Plug-Ins](#)
- [Server Settings](#)
- [Jailbreak Detection Policy](#)
- [Token Life Cycle Management](#)

### 53.3.1 Configuring Identity Domains

See [Configuring OAuth Services Components in an Identity Domain](#) for introductory information about Identity Domains. The following section describes how to use the user interface to configure an Identity Domain. It includes the following topics:

- [Creating an Identity Domain](#)
- [Editing or Deleting an OAuth Identity Domain](#)
- [Identity Domain Configuration Page - Summary Tab](#)
- [Create Identity Domain Wizard Flow Page](#)

#### 53.3.1.1 Creating an Identity Domain

You can create an Identity Domain using single step or using a wizard flow.

To create:

1. Access the Identity Domains page as described in [Configuring OAuth Services Components in an Identity Domain](#).
2. Choose one of the following:
  - To quickly create an Identity Domain with only basic information, click **Create using single step** (leftmost + button in the toolbar).  
The Identity Domain Configuration page opens.  
Complete the form and click **Create** to save your changes. You will need to provide additional configuration detail later.
  - To create an Identity Domain *and* configure essential Service Profile settings, click **Create using wizard flow** (rightmost + button in the toolbar).  
The Create OAuth Identity Domain wizard flow page opens.

Click **Back** and **Next** to move backwards and forward through the wizard flow. Click **Finish** to save your changes.

### 53.3.1.2 Editing or Deleting an OAuth Identity Domain

You can view, edit, and delete an OAuth Identity Domain.

To edit an OAuth Identity Domain:

1. Open the Identity Domains page as described in [Configuring OAuth Services Components in an Identity Domain](#).
  - To view or edit an Identity Domain, click its name in the table.
  - To delete an Identity Domain, select it by clicking the column to the left of the domain name and then click the delete button in the command bar.

### 53.3.1.3 Identity Domain Configuration Page - Summary Tab

When you view an existing identity domain or create a new one, the Identity Domain Configuration **Summary** tab displays form fields such as **Identity Domain**, **Identity Domain UUID**, and **Allow Multiple Resource Servers**.

This section describes the form fields on the Identity Domain Configuration **Summary** tab when viewing an existing identity domain or creating a new one.

**Identity Domain** - The name of the identity domain. If creating or editing an identity domain, type a unique name without spaces.

**Description** - (Optional) A short description to help you or another administrator identify this identity domain in the future.

**Identity Domain UUID** - The identification code that uniquely identifies this identity domain on the Internet. Click **Generate** to populate this field with a universal unique identifier code.

**Allow Multiple Resource Servers** - Select this option if the identity domain supports more than one resource server.

---

---

**Note:**

Selecting multiple resources requires that scopes are prefixed with the Resource Server name. For example, if you add PhotoService as a Resource Server, the scopes must be prefixed with PhotoService. This is done automatically while adding scopes in the Resource Server. The prefix can be changed to something different but unique.

---

---

The fields listed below appear on the Create Identity Domain page.

#### Service Profile

**(Service Profile) Name** - The name of the identity domain's service profile. Each identity domain requires at least one service profile. See [Service Profiles - Identity Federation and OAuth Services](#) for more information.

**(Service Profile) Endpoint** - The URL where the OAuth authorization service for this identity domain responds to authorization requests.

### User Profile Service

**(User Profile Service) Name** - The name of the identity domain's user profile service. A user profile service is created automatically for each identity domain. See [Resource Servers - Identity Federation and OAuth Services](#) for more information.

**(User Profile Service) Endpoint** - The URL where the User Profile Service receives and responds to create, read, update, and delete requests.

### Consent Management Service

**(Consent Management Service) Name** - The name of the identity domain's consent management service. Each identity domain must have a consent management service, which stores and retrieves consent records, and performs consent validation and consent revocation operations. See [Plug-Ins - Identity Federation and OAuth Services](#) for more information.

**(Consent Management Service) Endpoint** - The URL where the Consent Management Service receives and responds to client and resource owner service requests.

#### 53.3.1.4 Create Identity Domain Wizard Flow Page

You understand the form fields on the create OAuth Identity Domain Wizard Flow Page before creating Wizard Flow.

Refer to the following sections for details on the form fields available in the Create OAuth Identity Domain wizard flow page:

- **Information** - For help, see [Identity Domain Configuration Page - Summary Tab](#) .
- **Service Profile** - For help, see [Service Profile Configuration Page](#).
- **Mobile Service** - For help, see "Mobile Service Settings" in [Service Profile Configuration Page](#).
- **Tokens** - For help, see "Tokens (Token Settings)" in [Service Profile Configuration Page](#).
- **Summary** - Review your settings and click **Finish** to create the identity domain.

## 53.3.2 Configuring Service Profiles

You can configure a service profile using user interface.

See [Service Profiles - Identity Federation and OAuth Services](#) for introductory information about Service Profiles. The following section describes how to use the user interface to configure a Service Profile. It includes the following topics:

- [Creating a Service Profile](#)
- [Editing or Deleting a Service Profile](#)
- [Service Profile Configuration Page](#)

### 53.3.2.1 Creating a Service Profile

You can create a service profile using **Service Profiles** tab.

1. Access the Identity Domains page as described in [Configuring OAuth Services Components in an Identity Domain](#) and click the identity domain to open it.

2. Select the **Service Profiles** tab.
3. Click **Create** to complete the wizard.

### 53.3.2.2 Editing or Deleting a Service Profile

You can edit or delete a service profile from the **Service Profile** tab.

1. Open the Identity Domains page as described in [Configuring OAuth Services Components in an Identity Domain](#) and click an identity domain to open it for editing.
2. Click the **Service Profiles** tab.
3. Do the following:
  - To edit a service profile, click its name in the table.
  - To delete a service profile, select it by clicking the box to the left of the name and then click the delete button in the command bar.

### 53.3.2.3 Service Profile Configuration Page

**Identity Domain** - The name of the identity domain to which this service profile applies. (Read-only)

**Name** - The name of this service profile.

**Description** - (Optional) A short description to help you or another administrator identify this service profile in the future.

**Service Enabled** - Select to activate the service profile, or clear the option box to inactivate it.

**Service Provider** - The name of the OAuth Service Provider that corresponds with this OAuth Service Profile.

**Service Endpoint** - The URL where the OAuth authorization service responds to authorization requests.

#### User Store

**User Authenticator** - For user authentication, choose **OAM** to use the Oracle Access Management token provider, or choose **IDS** to use the Identity Directory Service token provider. Only choose IDS authentication if the OAM token is not used at all (for example, if only the JWT token is used). If both OAM and JWT tokens are used, choose OAM authentication to avoid duplicated authentication attempts sent by both IDS and OAM.

**Identity Store Name** - The name of the identity store when IDS is configured as the user authenticator.

#### User Profile Service

**(User Profile Service) Name** - The name of the identity domain's user profile service. A user profile service is created automatically for each identity domain. See [User Profile Services](#) for more information.

**(User Profile Service) Endpoint** - The URL where the User Profile Service receives and responds to create, read, update, and delete requests.

### Consent Management Service

**(Consent Management Service) Name** - The name of the identity domain's consent management service. Each identity domain must have a consent management service, which stores and retrieves consent records, and performs consent validation and consent revocation operations. See [Consent Management Services](#) for more information.

**(Consent Management Service) Endpoint** - The URL where the Consent Management Service receives and responds to client and resource owner service requests.

### Plug-Ins

Choose available plug-ins from the menus in the following categories. See [Plug-Ins - Identity Federation and OAuth Services](#) for more information.

**Adaptive Access** - Runs Oracle Adaptive Access Manager (OAAM) fraud detection and risk analysis policy checks, enhancing authenticity and the trust level of a user.

**Mobile Security Manager** - Gathers mobile device data from the Mobile Security Manager (MSM) component (part of Oracle Mobile Security Suite) and sends it, as well as the MSM compliance status, to the Adaptive Access Plug-in for stronger authentication checks and risk evaluation.

**Custom Token Attributes** - Defines security policy around the token service provider. See [OAuth Services Access Tokens](#) for more information.

**Client** - Delegates the following to an external security module: confidential client authentication, client authorization, and client profile reading.

**Resource Server Profile** - Delegates the following to an external security module: confidential resource server authentication, resource server authorization, and resource server profile reading.

**Authorization & Consent Service** - Defines security policy around interactions where authorization and user consent are granted. This plug-in can influence claims in a generated token as well.

### Attributes

Add or delete service profile attributes and their values to further configure the OAuth service profile.

For JWT token generation and validation, configure the following parameters:

- `jwt.cert.alias`
- `jwt.trusted.issuer.size`
- `jwt.trusted.issuer.1`
- `jwt.trusted.issuer.2`

---

---

**Note:**

For details, see [Configuring OAuth Services for Third-Party JWT Bearer Assertions](#).

---

---



**Table 53-1 OAuth Service Profile Configuration Attributes**

Name	Value	Notes
<code>jwt.cert.alias</code>		Private key alias name for the signing certificate in the keystore. The default alias will be used if this attribute is not specified.
<code>jwt.CryptoScheme</code>	<code>RS512</code>	The cryptographic algorithm used to sign the contents of the JWT token. The default value is <code>RS512</code> . (RSA encryption using SHA-512 hash algorithm.)
<code>jwt.issuer</code>	<code>www.oracle.example.com</code>	This issuer of the tokens (that is, the <code>iss</code> claim value in the JWT token generated by OAuth Services). The default value, <code>www.example.oracle.com</code> , needs to be changed in the deployment.
<code>jwt.trusted.issuer.size</code>	<code>2</code>	The number of trusted issuers. The value can be any number of trusted issuers. For example, if the number is 2, the following matching params need to be specified.
<code>jwt.trusted.issuer.1</code>		The alias name for the public key of the first trusted issuer in the key store. See <code>jwt.trusted.issuer.size</code> for details.
<code>jwt.trusted.issuer.2</code>		The alias name for the public key of the second trusted issuer in the key store. See <code>jwt.trusted.issuer.size</code> for details.
<code>createdByDefault</code>	<code>true</code>	If set to true, the current OAuth Services profile is created automatically as part of domain creation. Otherwise, it's created manually.
<code>clientPWDValidation</code>	<code>false</code>	If set to true, a client ID and secret (password) can be used as credentials to interact with OAuth Services for token validation and termination requests. If set to false, only a JWT/SAML client assertion can be used as client credentials to interact with OAuth Services for token validation and termination requests.
<code>tokenTenantClaimName</code>	<code>user.tenant.name</code>	The tenant claim name in the tokens issued by OAuth Services. By default this is set using the identity domain name.
<code>oauthServerSelfClientId</code>	Value to be specified	By default this is set with the value of the <code>jwt.issuer</code> attribute. This attribute gets used when OAuth Services generates a client assertion for itself when interacting with other services such as service-to-service interactions.

**Table 53-1 (Cont.) OAuth Service Profile Configuration Attributes**

Name	Value	Notes
oauthServerSelfCTValidityInSec	Value in seconds to be specified	The default value is 300sec. This attribute is related to <code>oauthServerSelfClientId</code> (that is, the OAuth Services own client assertion validity period).
msAlwaysShowLogin	true/false	<p>This attribute applies to mobile clients using the JWT SSO authentication mechanism. It is used with 2-legged flows only. (For 3-legged flows, the browser manages the session.)</p> <p><b>true</b> - The user must authenticate for each app registration. (Mobile apps are not registered using the server-side JWT user token.) OAuth Services shows a login page for the user to submit credentials.</p> <p><b>false</b> - Mobile apps are registered using the server-side JWT user token.</p> <p>By default <code>true</code>.. If this attribute is not defined in the service profile, the server does not allow mobile apps to use the server-side user token to register without a user name and password. For more information see <a href="#">Understanding Server-Side SSO For Mobile OAuth Services 2-Legged Flows</a>.</p>

### Mobile Service Settings

**Supported Platforms** - Choose iOS, Android, and/or Others:

- **iOS** - The authorization server accepts requests from iOS clients if selected.
- **Android** - The authorization server accepts requests from Android clients if selected.
- **Others** - The authorization server accepts requests from clients other than iOS or Android if selected.

**iOS Security Level** - Choose Advanced or Standard:

- **Advanced** - All client registrations and token acquisitions are done using both push notification and HTTP(S).
- **Standard** - All client registrations and token acquisitions are done using HTTP(S)

**Android Security Level** - Choose Advanced or Standard:

- **Advanced** - All client registrations and token acquisitions are done using both push notification and HTTP(S).
- **Standard** - All client registrations and token acquisitions are done using HTTP(S)

**Android Sender ID** - Enter the GCM sender ID that is required for Android push notification.

**Android API Key** - Enter the API key required for Android push notification.

**Consent Service Protection** - Authorization requests are routed to the consent service, which requires the user to log in and give consent. Select **OAM or Third-Party Access Management**, **JWT Authentication**, or **Social Authentication**.

- **OAM or Third-Party Access Management** - Use either Oracle Access Management or a third-party option for consent page protection.
- **JWT Authentication** - Use the OAuth server itself for consent page protection. If using the OAuth server for consent page protection, the authentication flow is determined by the **User Store** setting.
- **Social Authentication** - Use the **Social Identity** service for consent page protection.

**Require User Consent for Client Registration** - Select this option to require the user to give authorization before registering each Mobile OAuth application installation instance on a mobile device.

**Enable Server-Side Single Sign-On** - Determines if the server will provide single sign-on among multiple apps on the same device or if it is the client responsibility. Single sign-on is either achieved by storing a JWT user token or an OAM user token in the Server-Side Device Store, or by returning the user token to the client to manage. Server-side SSO applies to 2-legged Mobile OAuth flows only. If this option is selected, after registering the first app the server stores the user token and does not return it to the mobile device. If this option is not selected, the tokens are sent to the mobile device and are not stored in the Server Device Store. For more information, see [Understanding Mobile OAuth Services Server-Side Single Sign-on](#).

**Preferred Hardware IDs** - Use the list to prioritize the hardware ID attributes that should be used to uniquely identify mobile devices. The first available hardware ID from the list will be used.

**Mobile Client Attributes** - Add or delete mobile client attributes and their values as needed if the server requires additional attributes.

## Configuration Settings

### Clients

**Allow access to all clients** - Select if all clients in the identity domain should use this service profile. Clear this option to select which clients will be able to access the service profile.

**Client Table** - Add to the table the clients that should be able to access the service profile. Click **Browse Clients**, then select the clients to add to the table. To assign a client to a different service profile, click the box to the left of the client name and click **Remove**.

### Tokens (Token Settings)

Use this tab to configure token settings, as well as settings for custom attribute that OAuth Services should embed in access tokens.

### Tokens

- **Token Name** - The name of the token.
- **Expires** - The length of time in minutes after which the token is no longer valid.
- **Refresh Token Enabled** - Select this option to allow a refresh token to be used. A refresh token cannot be used with a client verification code or an authorization code. See [About OAuth Services Tokens](#) for more information.
- **Refresh Token Expires** - The length of time in minutes after which the refresh token is no longer valid.
- **Life Cycle Enabled** - Select this option if OAuth Services should cache a token and save it in the database until the token expires.

### Custom Attributes

Use this section to define custom attributes that OAuth Services embeds in the access tokens. See [OAuth Services Access Tokens](#) for more information about custom attributes.

- **Static Attributes** - Attribute name and value pairs where the value is fixed at the time that you define the attribute. For example, `name1=value1`.
- **Dynamic Attributes** - User-profile specific attributes.

### Resource Servers (Custom Resource Servers)

Use this tab to choose which custom resource servers clients should have access to. A custom resource server is any resource server that is not the User Profile and Consent Management resource servers that are included with OAuth Services.

**Allow clients access to all resource servers** - Select to allow clients to access all resource servers configured in the identity domain. Clear this option to select which resource servers clients will be able to access.

**Available Servers / Selected Servers** - Use the arrows to move the resource servers that clients should be able to access from the **Available Servers** box to the **Selected Servers** box. (This option is only available if the **Allow clients access to all resource servers** option is not selected.)

### System Resource Servers

Use this tab to configure if clients should have access to the user profile service and/or consent management service.

**User Profile Services** - Use the arrows to move the user profile server that clients should be able to access from the **Available Servers** box to the **Selected Servers** box. Services listed in the **Selected Servers** box are active services.

**Consent Management Services** - Use the arrows to move the consent management server that clients should be able to access from the **Available Servers** box to the **Selected Servers** box. Services listed in the **Selected Servers** box are active services.

### Trusted Issuers

Use this tab to add certificate issuers who can be used to validate tokens. Click **Add** to add a record to the table; select a row and click **Remove** to delete a record from the table.

**Certificate Alias** - The alias name.

**Trusted Issuer** - The name of the trusted certificate issuer.

**Certificate Thumb Print - x5t** - The base64url encoded digest of the DER encoding of the X.509 certificate corresponding to the key used to digitally sign certificates.

**Key identifier - kid** - The key ID value that indicates which key is used to secure certificates.

### 53.3.3 Configuring Clients

See [Clients - Identity Federation and OAuth Services](#) for introductory information about OAuth Services Clients. The following section describes how to use the user interface to configure a Web client and a mobile client. It includes the following topics:

- [Creating a Client](#)
- [Editing or Deleting a Client](#)
- [Web Clients Configuration Page](#)
- [Mobile Clients Configuration Page](#)

#### 53.3.3.1 Creating a Client

You can create a client using the **Clients** tab.

1. Access the Identity Domains page as described in [Configuring OAuth Services Components in an Identity Domain](#) and click the identity domain to open it.
2. Select the **Clients** tab.
3. Click Create and a Create Client tab will open as follows.
  - To create an OAuth Services Web (non-mobile) client, click the Create button located directly under the **OAuth Web Clients** heading.  
See [Web Clients Configuration Page](#).
  - To create an OAuth Services Public client, click the Create button located directly under the **OAuth Public Clients** heading.  
See [Public Clients Configuration Page](#).
  - To create an OAuth Services mobile client, click the **Create** button located directly under the **OAuth Mobile Clients** heading.  
See [Mobile Clients Configuration Page](#).
4. Enter the appropriate values in the form displayed under the **Create Client** tab.

#### 53.3.3.2 Editing or Deleting a Client

You can edit or delete a client from the **Clients** tab.

1. Open the Identity Domains page as described in [Configuring OAuth Services Components in an Identity Domain](#) and click an identity domain to open it for editing.
2. Click the **Clients** tab.
3. Do the following:

- To edit a client configuration, click its name on the page.  
The client configuration page opens in a new tab.
- To delete a client, select it by clicking the box to the left of the name and then click the delete button in the command bar.

### 53.3.3.3 Web Clients Configuration Page

When you view an existing Web client or create a new one, the OAuth Web Clients Configuration Page displays the form fields such as **Identity Domain**, **Client ID**, and **Client Secret**.

The form fields on the Web Client Configuration page are as follows:

**Identity Domain** - The name of the identity domain in which this OAuth Web client is registered. (Read-only)

**Name** - The name of this OAuth client.

**Description** - (Optional) A short description to help you or another administrator identify this OAuth Web client in the future.

**Allow Token Attributes Retrieval** - Select this option to allow custom attributes (both attribute names and values) to be shared with resource servers and the resource owner. See [OAuth Services Access Tokens](#) for more information about custom attributes.

**Client ID** - The unique ID that the authorization server created for this client during registration. (Read-only).

**Client Secret** - A secret value known to the OAuth authorization service and the client. The authorization service checks the client secret and the client ID when it receives token endpoint requests from the client.

**HTTP Redirect URIs** - The client URIs that the OAuth server is allowed to redirect the user-agent to once access is granted or denied.

#### Privileges

**Bypass User Consent** - If selected, the client will not ask for the user's explicit authorization to access the user's protected resources. If this option is selected, this setting overrides the resource server setting. Clear this option if the client should be subject to the resource server setting.

**Allow Access to all Scopes** - If selected, the client can obtain an access token regardless of scope limitations for any resource server in the identity domain. Clear this option if the client should be subject to scope limitations.

**Allowed Scopes** - Lists the range of access the client has to the requested resources. To grant additional access, click **Add** to add a row to the table, then choose from the drop-down menu the scope to be added. To restrict access, select the scope that you want to remove by clicking the table row, then click **Delete** to remove the highlighted row. Click **OK** at the prompt to confirm that you want to remove the selected scope.

**Grant Types** - The OAuth 2.0 specification provides several authorization grant types for different security use-cases. Before obtaining an access token, the client must obtain an authorization grant that it can exchange with the OAuth service for an access token. Client privileges determine which clients are allowed which grant types. The following grant types are supported in OAuth Services:

- **Authorization Code** - This grant type is required for 3-legged flows. The resource owner logs in using the authorization server. The token endpoint exchanges the authorization code along with client credentials for an access token.
- **Resource Owner Credentials** - This grant type is used for 2-legged flows. The resource owner provides the client with his or her user name and password. This is only suitable for highly trusted client applications because the client could abuse the password, or the password could unintentionally be disclosed to an attacker. Per the OAuth 2.0 specification, the authorization server and client should minimize use of this grant type and utilize other grant types whenever possible.
- **Client Credentials** - This grant type is used for 2-legged flows. The client requests an access token using only its client credentials (or another supported means of authentication). This is suitable if the client is requesting access to protected resources under its control, or those of another resource owner when previously arranged with the authorization server.

In addition to the grant types defined in the OAuth 2.0 standard, the following options are also available:

- **Refresh Token** - Select this option to return a refresh token together with an access token in the token response. See [About OAuth Services Tokens](#) for more information.
- **JWT Bearer** - Allows a JWT assertion to be used to request an OAuth access token.
- **SAML 2 Bearer** - Allows a SAML2 assertion to be used to request an OAuth access token.
- **OAM Credentials** - Used to request OAM tokens, such as a master token, an access token, or an OAuth access token.

### Attributes

Add or delete custom attributes that the authorization server returns to the client along with the scope settings.

Avoid using the same name when adding custom attributes to the service profile configuration and the scope configuration. If you define the same attribute name in both locations, the scope-based attribute value takes precedence.

**Table 53-2 Web Client Attributes Names and Values**

Name	Value	Notes
<code>jwt.audience</code>	Space separated values.	Used when the OAuth server generates a client assertion and a user assertion. The aud claim for those JWT tokens contain the defined values in this token.

### 53.3.3.4 Public Clients Configuration Page

When you view an existing Web client or create a new one, the Web Client Configuration page displays the form fields such as **Identity Domain**, **Client ID**, and **HTTP Redirect URIs**.

The form fields on the Web Client Configuration page are as follows:

**Identity Domain** - The name of the identity domain in which this OAuth Web client is registered. (Read-only)

**Name** - The name of this OAuth client.

**Description** - (Optional) A short description to help you or another administrator identify this OAuth Web client in the future.

**Allow Token Attributes Retrieval** - Select this option to allow custom attributes (both attribute names and values) to be shared with resource servers and the resource owner. See [OAuth Services Access Tokens](#) for more information about custom attributes.

**Client ID** - The unique ID that the authorization server created for this client during registration. (Read-only).

**HTTP Redirect URIs** - The client URIs that the OAuth server is allowed to redirect the user-agent to once access is granted or denied.

### Privileges

**Bypass User Consent** - If selected, the client will not ask for the user's explicit authorization to access the user's protected resources. If this option is selected, this setting overrides the resource server setting. Clear this option if the client should be subject to the resource server setting.

**Allow Access to all Scopes** - If selected, the client can obtain an access token regardless of scope limitations for any resource server in the identity domain. Clear this option if the client should be subject to scope limitations.

**Allowed Scopes** - Lists the range of access the client has to the requested resources. To grant additional access, click **Add** to add a row to the table, then choose from the drop-down menu the scope to be added. To restrict access, select the scope that you want to remove by clicking the table row, then click **Delete** to remove the highlighted row. Click **OK** at the prompt to confirm that you want to remove the selected scope.

**Grant Types** - The OAuth 2.0 specification provides several authorization grant types for different security use-cases. Before obtaining an access token, the client must obtain an authorization grant that it can exchange with the OAuth service for an access token. Client privileges determine which clients are allowed which grant types. The following grant types are supported in OAuth Services:

- **Authorization Code** - This grant type is required for 3-legged flows. The resource owner logs in using the authorization server. The token endpoint exchanges the authorization code along with client credentials for an access token.
- **Implicit** - This grant type is used for 2-legged flows. The resource owner provides the client with his or her user name and password. This is only suitable for highly trusted client applications because the client could abuse the password, or the password could unintentionally be disclosed to an attacker. Per the OAuth 2.0 specification, the authorization server and client should minimize use of this grant type and utilize other grant types whenever possible.

### Attributes

Add or delete custom attributes that the authorization server returns to the client along with the scope settings.



Avoid using the same name when adding custom attributes to the service profile configuration and the scope configuration. If you define the same attribute name in both locations, the scope-based attribute value takes precedence.

### 53.3.3.5 Mobile Clients Configuration Page

When you view an existing Mobile client or creating a new one, the Mobile Client Configuration page displays form fields such as **Identity Domain**, **Client ID**, and **Jailbreaking Detection**.

This section describes the form fields on the Mobile Client Configuration page when viewing an existing Mobile client or creating a new one. The *OAuth Web Client Configuration* page is described in the previous section.

**Identity Domain** - The name of the identity domain in which this OAuth mobile client is registered. (Read-only)

**Name** - The name of this OAuth client.

**Description** - (Optional) A short description to help you or another administrator identify this OAuth mobile client in the future.

**Allow Token Attributes Retrieval** - Select this option to allow custom attributes (both attribute names and values) to be shared with resource servers and the resource owner. See [OAuth Services Access Tokens](#) for more information about custom attributes.

**Client ID** - The unique ID that the authorization server created for this client during registration. (Read-only).

**Jailbreaking Detection** - Select to enable jail breaking detection for mobile devices. See [Jailbreak Detection Policy - OAuth Services](#) for more information.

**Mobile Redirect URIs** - The client URIs that the OAuth server is allowed to redirect the user-agent to once access is granted or denied.

#### Privileges

**Bypass User Consent** - If selected, the client will not ask for the user's explicit authorization to access the user's protected resources. If this option is selected, this setting overrides the resource server setting. Clear this option if the client should be subject to the resource server setting.

**Allow Access to all Scopes** - If selected, the client can obtain an access token regardless of scope limitations for any resource server in the identity domain. Clear this option if the client should be subject to scope limitations.

**Allowed Scopes** - Lists the range of access the client has to the requested resources. To grant additional access, click **Add** to add a row to the table, then choose from the drop-down menu the scope to be added. To restrict access, select the scope that you want to remove by clicking the table row, then click **Delete** to remove the highlighted row. Click **OK** at the prompt to confirm that you want to remove the selected scope.

**Grant Types** - The OAuth 2.0 specification provides several authorization grant types for different security use-cases. Before obtaining an access token, the client must obtain an authorization grant that it can exchange with OAuth Services for an access token. Client privileges determine which clients are allowed which grant types. The following grant types are supported in OAuth Services:

- **Authorization Code** - This grant type is required for 3-legged flows. The resource owner logs in using the authorization server. The token endpoint exchanges the authorization code along with client credentials for an access token.
- **Resource Owner Credentials** - This grant type is used for 2-legged flows. The resource owner provides the client with his or her user name and password. This is only suitable for highly trusted client applications because the client could abuse the password, or the password could unintentionally be disclosed to an attacker. Per the OAuth 2.0 specification, the authorization server and client should minimize use of this grant type and utilize other grant types whenever possible.
- **Client Credentials** - This grant type is used for 2-legged flows. The client requests an access token using only its client credentials (or another supported means of authentication). This is suitable if the client is requesting access to protected resources under its control, or those of another resource owner when previously arranged with the authorization server.
- **Refresh Token** - Select this option to return a refresh token together with an access token in the token response. See [About OAuth Services Tokens](#) for more information.
- **JWT Bearer** - Allows a JWT assertion to be used to request an OAuth access token.
- **SAML 2 Bearer** - Allows a SAML2 assertion to be used to request an OAuth access token.
- **OAM Credentials** - Used to request OAM tokens, such as a master token, an access token, or an OAuth access token.
- **Client Verification Code** - Used by mobile clients to request a pre-verification code from OAuth server, which subsequently gets used mobile client flows.

### Apple Push Notification

Applies to iOS devices only. The OAuth authorization server can restrict token delivery to a specific app installed on a specific mobile device by sending part of the client registration handle through HTTPS, and sending the other part through push notification using the Apple Push Notification Service (APNS). Use the following fields to configure how the OAuth server connects to APNS for this specific client app.

**Connection Settings** - Select **Enabled** to send a portion of security codes and tokens to the mobile client app using APNS. (The portions not sent using APNS are sent using HTTPS.) Clear this option if you do not want to use APNS for this mobile client app.

**Minimum Connection Pool Size** - Specifies the minimum number of connections in the connection pool.

**Maximum Connection Pool Size** - Specifies the maximum number of connections in the connection pool.

**Keep Alive** - The Apple Push Notification keep alive value in seconds.

**Certificate for APNS Communication Setup** - Choose **Development** to use the Apple development environment for initial development and testing of the application; choose **Production** to use Apple's production environment.

**SSL/TLS Certificate for Development** - Click **Browse** to navigate to the development SSL/TLS certificate issued by Apple for the Apple Push Notification Service.

**Development Certificate Password** - Type the development password for the Apple Push Notification certificate.

**SSL/TLS Certificate for Production** - Click **Browse** to navigate to the production SSL/TLS certificate issued by Apple for the Apple Push Notification Service.

**Production Certificate Password** - Type the production password for the Apple Push Notification certificate.

### Google Application Settings

Applies to Android devices only. The OAuth authorization server can restrict token delivery to a specific app installed on a specific mobile device by sending part of the client registration handle through HTTPS, and sending the other part through push notification using Google Cloud Messaging (GCM) for Android. Use the following fields to configure how the OAuth server connects to the GCM service for this specific client app.

**Restricted Package Name** - The Google restricted package name.

### Mobile Service Settings

**Override the default settings** - By enabling Override the default settings in a Mobile Client profile, an administrator can set the security level and enable server-side single sign on at the client level. When set, these client settings override same settings at the OAuth Services Service Profile mobile configuration setting. This can be used if a particular client in an identity domain needs a behavior that is different from what is defined in the OAuth Services Service Profile.

### Configuration Settings

**Device Claim Attributes** - Specifies the device attributes that the system should collect for device fingerprinting. If empty, the system collects every attribute in the SDK.

**Mobile Custom Attributes** - Specifies key-value pairs that should be sent to mobile applications using app profiles. (Mobile applications request app profiles that contain server-side settings, including endpoints, jail break detection policies, and security level details.

### Attributes

Add or delete custom attributes that the authorization server returns to the client along with the scope settings.

Avoid using the same name when adding custom attributes to the service profile configuration and the scope configuration. If you define the same attribute name in both locations, the scope-based attribute value takes precedence.

## 53.3.4 Configuring the Service Provider

See [Service Providers - Identity Federation and OAuth Services](#) for introductory information about Service Providers. The following section describes how to use the user interface to configure a Service Provider. It includes the following topics:

- [Editing or Deleting the Service Provider](#)
- [Service Provider Configuration Page](#)

**Note:**

Only one Service Provider can be configured at a time.

**53.3.4.1 Editing or Deleting the Service Provider**

You can edit or delete a Service provider from the **Service Providers** tab.

1. Access the Identity Domains page as described in [Configuring OAuth Services Components in an Identity Domain](#) and click the identity domain to open it for editing.
2. Select the **Service Providers** tab.
3. Do the following:
  - To edit a service provider, click its name in the table.
  - To delete a service provider, select it by clicking the box to the left of the name and then click the delete button in the command bar.

**53.3.4.2 Service Provider Configuration Page**

Following are the form fields on the Service Provider Configuration page:

**Identity Domain** - The name of the identity domain with which this Service Provider is registered. (Read-only)

**Name** - The name of this service provider.

**Description** - (Optional) A short description to help you or another administrator identify this service provider.

**Service Provider Java Class** - The Java class that implements this service provider.

**Attributes**

Use the attribute settings in [Table 53-3](#) to configure the Service Provider connection with Access Manager.

**Table 53-3 OAuth Service Provider Attributes for Access Manager**

Name	Value	Notes
oam.OAM_VERSION	OAM_11G	Either <b>OAM_11G</b> or <b>OAM_10G</b> , depending on the Oracle Access Manager version in use.
oam.Webgate_ID	accessgate-oic	
oam.ENCRYPTED_PASSWORD		
oam.DEBUG_VALUE	0	

**Table 53-3 (Cont.) OAuth Service Provider Attributes for Access Manager**

Name	Value	Notes
oam.TRANSPORT_SECURITY	OPEN	Specify the method for encrypting messages between this AccessGate and the Access Servers. The encryption methods need to match. Valid values include: <ul style="list-style-type: none"> <li>• OPEN</li> <li>• SIMPLE</li> <li>• CERT</li> </ul> To update these settings, see <a href="#">Configuring Mobile and Social Services to Work With Access Manager in Simple and Certificate Mode</a> .
oam.OAM_SERVER_1	localhost:5575	Specify the host name and port number of the primary Oracle Access Management server.
oam.OAM_SERVER_1_MAX_CONN	4	Specify the maximum number of connections that this Mobile and Social instance can establish with OAM_SERVER_1. The default value is 4.
oam.OAM_SERVER_2	oam_server_2:5575	Specify the host name and port number of the secondary Oracle Access Management server.
oam.OAM_SERVER_2_MAX_CONN	4	Specify the maximum number of connections that this Mobile and Social instance can establish with OAM_SERVER_2. The default value is 4.
oam.AuthNURLForUID	wl_authen://sample_ldap_no_pwd_protected_res	
oam.OAM_LOCAL_MODE	true	Specifies if Mobile and Social should use "local mode" or "remote mode" to communicate with the OAM server. If the attribute value is set to <b>false</b> , Mobile and Social communicates with OAM over TCP/IP. If set to <b>true</b> (or if this attribute is undefined), Mobile and Social uses a direct connection to communicate with OAM.  Prior to version 11.1.2.3, Mobile and Social only communicated with OAM using TCP/IP (that is, remote mode). Now communication defaults to local, which is faster.  To configure Mobile and Social to communicate with OAM 10g, set the OAM_LOCAL_MODE attribute to <b>false</b> .

## 53.3.5 Configuring Custom Resource Servers

You can configure a Resource Server using the user interface.

See [Resource Servers - Identity Federation and OAuth Services](#) for introductory information about Resource Servers. The following section describes how to use the user interface to configure a Resource Server. It includes the following topics:

- [Creating a Custom Resource Server](#)
- [Editing or Deleting a Resource Server](#)
- [Custom Resource Servers Configuration Page](#)

OAuth Services provides two out-of-the-box services modeled as Resource Servers and protected with an Access Token. For configuration information on the User Profile Services and Consent Management Services Resource Servers, see [Configuring User Profile Services](#) and [Configuring Consent Management Services](#) respectively.

### 53.3.5.1 Creating a Custom Resource Server

You can create a Custom Resource Server from the **Resource Servers** tab.

1. Access the Identity Domains page as described in [Configuring OAuth Services Components in an Identity Domain](#) and click the identity domain to open it.
2. Select the **Resource Servers** tab.
3. To define a new resource server for use with OAuth Services, click the Create button in the **Custom Resource Servers** section.

The Custom Resource Server Configuration page opens.

### 53.3.5.2 Editing or Deleting a Resource Server

You can edit and delete a Resource Server from the **Resource Servers** tab.

1. Access the Identity Domains page as described in [Configuring OAuth Services Components in an Identity Domain](#) and click the identity domain to open it for editing.
2. Click the **Resource Servers** tab.
3. To open a configured custom Resource Server for editing, click its name in the Custom Resource Servers table.

The Custom Resource Server Configuration page opens.

### 53.3.5.3 Custom Resource Servers Configuration Page

The tabs and form fields in the Custom Resource Servers Configuration Page are discussed here.

**Identity Domain** - The name of the identity domain to which this resource server applies. (Read-only)

**Name** - The name of this resource server (or *resource service*).

**Description** - (Optional) A short description to help you or another administrator identify this resource server in the future.

**Allow Token Attributes Retrieval** - Select this option to allow custom attributes (both attribute names and values) to be shared with clients and the resource owner. See [OAuth Services Access Tokens](#) for more information about custom attributes.

**Authorization & Consent Service Plug-in** - From the menu, choose an authorization plug-in for the resource server. This plug-in type defines security policy around interactions where authorization and user consent are granted. It can influence claims in a generated token as well. See [Plug-Ins - Identity Federation and OAuth Services](#) for plug-in descriptions.

**Audience Claim** - Identifies the audiences for which the OAuth token is intended. Each principal intended to process the OAuth token must identify itself with a value in **Audience Claim**.

**Resource Server ID** - The unique ID created for this resource server during registration. (Once the resource server configuration is saved, this field cannot be changed.)

### Scopes

Click **Add** to add a new row to the scopes table. Click to select a row, then click **Delete** to remove it.

**Name** - Type a scope definition. Use dot notation, for example: `photo.read`

**Description** - Type a short note that describes the scope.

**Require User Consent** - Select to require the authorization server to display a user consent form so that the user can approve (or deny) the access request.

**Offline Scope** - Allows client applications to request a refresh token that can be used to obtain an access token even when the user is offline or not present. Client applications use the refresh token to get a new access token to access resources. See [About OAuth Services Tokens](#) for more information.

### Token Settings

**Override the default settings** - Select this option if the token settings defined on the resource server configuration page should override the default token settings defined on the OAuth Services profile page.

**Token Name** - The name of the token.

**Expires** - The length of time in minutes after which the token is no longer valid.

**Refresh Token Expires** - The length of time in minutes after which the refresh token is no longer valid.

### Custom Attributes

Use this section to define custom attributes that OAuth Services embeds in the access tokens. See [OAuth Services Access Tokens](#) for more information about custom attributes.

- **Static Attributes** - Attribute name and value pairs where the value is fixed at the time that you define the attribute. For example, `name1=value1`.
- **Dynamic Attributes** - User-profile specific attributes.

## 53.3.6 Configuring User Profile Services

You can configure an instance for the User Profile Services using the console.

See [User Profile Services](#) for introductory information about the User Profile Services. The following section describes how to use the console to configure an instance for the User Profile Services.

- [Creating a New User Profile Service](#)
- [Editing the User Profile Service](#)
- [User Profile Services Configuration Page](#)

### 53.3.6.1 Creating a New User Profile Service

You can create a New User Profile Service from the **Resource Servers** tab.

1. Open the Identity Domains page as described in [Configuring OAuth Services Components in an Identity Domain](#) and click the identity domain to open it.
2. Click the **Resource Servers** tab.
3. Click the Create button in the **User Profile Services** section.

The **User Profile Services Configuration** page opens.

### 53.3.6.2 Editing the User Profile Service

You can edit the User Profile Service from the **Resource Servers** tab.

1. Open the Identity Domains page as described in [Configuring OAuth Services Components in an Identity Domain](#) and click the identity domain to open it for editing.
2. Click the **Resource Servers** tab.
3. In the **User Profile Services** section, click the service name to edit it.

The **User Profile Services Configuration** page opens.

### 53.3.6.3 User Profile Services Configuration Page

You can configure the User Profile Service from the User Profile Services Configuration Page.

Use this page to configure the User Profile Service. This service supports OAuth 2.0 authorization and allows clients to interact with a back-end directory server and perform User Profile REST operations on Person, Group, and Relationship entities.

**Identity Domain** - The name of the identity domain to which this service profile applies. (Read-only)

**Name** - The name of this service profile.

**Description** - (Optional) A short description to help you or another administrator identify this service profile in the future.

**Service Enabled** - Select to enable the service, or clear the option box to disable it.

**Allow Token Attributes Retrieval** - Select this option to allow custom attributes (both attribute names and values) to be shared with clients. If enabled, the user consent form



notifies the user that user-profile-specific details will be shared with the client. See [OAuth Services Access Tokens](#) for more information about custom attributes.

**Audience Claim** - Identifies the audiences that the OAuth token is intended for. Each principal intended to process the OAuth token must identify itself with a value in audience claim.

**Resource Server ID** - The unique ID that OAuth Services created for this User Profile resource server. (Read-only)

**Service Endpoint** - The URI where the service receives and responds to create, read, update, and delete user profile service requests. Create a unique uniform resource identifier (URI) address for this service; for example, `localhost:5575`

**Authorization & Consent Service Plug-in** - From the menu, choose an authorization plug-in for the service. This plug-in type defines security policy around interactions where authorization and user consent are granted. It can influence claims in a generated token as well. See [Plug-Ins - Identity Federation and OAuth Services](#) for plug-in descriptions.

**Protected by OAuth Service Profile** - From the menu, choose the OAuth service profile that protects the user profile service.

**Identity Store Name** - The name of the identity store that contains the user records.

## Scopes

### Security Protection

Configure individual permission settings for person, relationship, and group entities. Click **Add** to add a record to the table; select a row and click **Delete** to remove the record. The service uses the following default entity names:

**URI** - The URI segment for which the scope is defined.

- `/me` - Designates operations that apply to the user logged in to the client
- `/users` - Designates operations that apply to other users
- `/groups` - Designates operations that apply to groups
- `/secretkey` - Designates operations that apply to secret key management

**Service Enabled** - Select to enable the service for this scope.

**Allow Read** - Select to allow read operations for this scope.

**Allow Write** - Select to allow write operations for this scope.

**Unprotected** - Select this option if you do not want to limit access, or clear this option to limit access by scope.

**OAuth Scope** - Type a scope definition. Use dot notation, for example:  
`UserProfile.me.write`

**Description** - Type a short note that describes the scope.

**Require User Consent** - Select to require the authorization server to display a user consent form so that the user can approve (or deny) the access request.

**Identity Attributes of the Selected Scope** - Click an entity row in the **Security Protection** table to view the Attribute table for that entity. Click **Add** to add a record to the table; select a row and click **Delete** to remove the record.

**Offline Scope** - Allows client applications to request a refresh token that can be used to obtain an access token even when the user is offline or not present. Client applications use the refresh token to get a new access token to access resources. See [About OAuth Services Tokens](#) for more information.

### Token Settings

**Override the default settings** - Select this option if the token settings defined on the resource server configuration page should override the default token settings defined on the OAuth Services profile page.

**Token Name** - The name of the token.

**Expires** - The length of time in minutes after which the token is no longer valid.

**Refresh Token Expires** - The length of time in minutes after which the refresh token is no longer valid.

### Proxy Authentication

Select Proxy Authentication to allow the identity of a user using a web application (also known as a "proxy") to be passed through the application to the database server. Oracle Unified Directory (OUD) and Active Directory (AD) support proxy authentication. The Access Control option is simply to provide Proxy Authentication support for directory servers that do not have it built in. See [Proxy Authentication](#) for more details.

### Attributes

Use this section to define user-profile specific (dynamic) attributes.

**Table 53-4 User Profile Service Attributes**

Name	Value
accessControl	false
adminGroup	cn=Administrators,ou=groups,ou=myrealm,dc=base_domain
selfEdit	true

### Resource URIs

Use this section to enable or disable the **/me**, **/users**, **/groups**, **/secretkey** services, and define the service endpoint URIs and provider implementation class paths for these services.

**Service Endpoint** - The URI where the service receives and responds to service requests. Create a unique uniform resource identifier (URI) address for this service; for example, `localhost:5575`

### Entities

Use the fields in this section to configure entity relationships.

- **Name** - The name of the defined entity relationship.
- **Identity Directory Service Relation** - Choose the directory service relationship that is to be accessed by the relationship **End Point** segment.

- **End Point** - Type an entity relationship URI segment that will be used to access a corresponding data column in the Identity Directory service. For example, if `memberOf` is the End Point URI, then:

```
http://<host>:<port>/.../idX/memberOf
```

would be the URI to access related entities of an entity with ID `idX`.

- **Source Entity URI** - The URI (or URL) of the source entity.
- **Destination Entity URI** - The URI (or URL) of the destination entity.
- **Scope for Requesting Recursion** - Use Scope attribute values with the scope query parameter to retrieve a nested level of attributes in a relationship search. To access related entities recursively, type the value to be used. The default configuration uses two scope attribute values: `toTop` and `all`. If the **Scope for Requesting Recursion** value is the attribute value `all`, then the following REST URI example is used to make the request:

```
http://host:port/.../idX/reports?scope=all
```

In this example, the URI returns the entities related to the entity with ID `idX`, as well as all further related entities.

### Attributes

Use this section to define user-profile entity specific (dynamic) attributes.

## 53.3.7 Configuring Consent Management Services

You can configure the Consent Management Services using the user interface.

See [Consent Management Services](#) for introductory information about the Consent Management Services. The following section describes how to use the user interface to configure the Consent Management Services.

- [Creating a New Consent Management Service](#)
- [Editing an Existing Consent Management Service](#)
- [Consent Management Services Configuration](#)

### 53.3.7.1 Creating a New Consent Management Service

You can create a New Consent Management Service from the **Resource Servers** tab.

1. Access the Identity Domains page as described in [Configuring OAuth Services Components in an Identity Domain](#) and click the identity domain to open it.
2. Click the **Resource Servers** tab.
3. Click the **Create** button in the **Consent Management Services** section.

The **Consent Management Service Configuration** page opens.

### 53.3.7.2 Editing an Existing Consent Management Service

You can edit an Existing Consent Management Service from the **Resource Servers** tab.

1. Access the Identity Domains page as described in [Configuring OAuth Services Components in an Identity Domain](#) and click the identity domain to open it for editing.
2. Click the **Resource Servers** tab.
3. In the **Consent Management Services** section, click the service name to edit it.

The **Consent Management Service Configuration** page opens.

### 53.3.7.3 Consent Management Services Configuration

The Consent Management Services handle consent storage, retrieval, revocation, and consent validation operations. You can configure the Consent Management Services.

Following are the form fields in the Consent Management Services configuration page:

**Identity Domain** - The name of the identity domain to which this consent management service applies. (Read-only)

**Name** - The name of this consent management service.

**Description** - (Optional) A short description to help you or another administrator identify this service in the future.

**Service Enabled** - Select to enable the service, or clear the option box to disable it.

**Allow Token Attributes Retrieval** - Select this option to allow custom attributes (both attribute names and values) to be shared with clients, resource servers, and the resource owner.

**Audience Claim** - Identifies the audiences that the OAuth token is intended for. Each principal intended to process the OAuth token must identify itself with a value in audience claim.

**Resource Server ID**- The unique ID that the authorization server created for this resource server during registration. (Read-only)

**Service Endpoint** - The URL where the Consent Management Service receives and responds to client and resource owner service requests.

**Authorization & Consent Service Plug-in** - From the menu, choose an authorization plug-in for the service. This plug-in type defines security policy around interactions where authorization and user consent are granted. It can influence claims in a generated token as well. See [Plug-Ins - Identity Federation and OAuth Services](#) for plug-in descriptions.

**Protected by OAuth Service Profile** - From the menu, choose the OAuth service profile that protects the consent management service.

### Scopes

#### Security Protection

Configure individual permission settings. Click **Add** to add a record to the table; select a row and click **Delete** to remove the record. The service uses the following default entity names:

**URI** - The URI segment for which the scope is defined.

- `/retrieve`
- `/grant`

- `/revoke`

**Allow Read** - Select to allow read operations for this scope.

**Allow Write** - Select to allow write operations for this scope.

**Unprotected** - Select this option if you do not want to limit access, or clear this option to limit access by scope.

**OAuth Scope** - Type a scope definition. Use dot notation, for example:  
`UserProfile.me.write`

**Description** - Type a short note that describes the scope.

**Require User Consent** - Select to require the authorization server to display a user consent form so that the user can approve (or deny) the access request.

**Offline Scope** - Allows client applications to request a refresh token that can be used to obtain an access token even when the user is offline or not present. Client applications use the refresh token to get a new access token to access resources. See [About OAuth Services Tokens](#) for more information.

### Token Settings

**Override the default settings** - Select this option if the token settings defined on the resource server configuration page should override the default token settings defined on the OAuth service profile page.

**Token Name** - The name of the token.

**Expires** - The length of time in minutes after which the token is no longer valid.

**Refresh Token Expires** - The length of time in minutes after which the refresh token is no longer valid.

### Attributes

Use this section to define custom attributes

### Resources URIs

Use this section to enable or disable the **retrieve**, **grant**, and **revoke** services. You can also define the service endpoint URIs and provider implementation class paths for these services.

**Service Endpoint** - The URI where the service receives and responds to requests. Create a unique URI address for this service.

**Service Enabled** - Select to enable the service, or clear the option box to disable it.

### Attributes

Use this section to define consent management entity-specific (dynamic) attributes.

## 53.3.8 Configuring Plug-Ins

You can configure security plug-ins.

See [Plug-Ins - Identity Federation and OAuth Services](#) for plug-in descriptions.

### 53.3.8.1 Creating a new Plug-in

You can create a new plug-in from the **Plug-ins** tab.

1. Access the Identity Domains page as described in [Configuring OAuth Services Components in an Identity Domain](#) and click the identity domain to open it.
2. Click the **Plug-ins** tab.
3. Click the **Create** button in one of the plug-in category sections.

The Plug-in Configuration page opens.

### 53.3.8.2 Plug-in Configuration Page

You can add a plug-in to an Identity Domain or edit an existing plug-in configuration from the Plug-in Configuration Page.

Only some of the fields listed below will apply to the plug-in you are configuring.

**Identity Domain** - The name of the identity domain where the plug-in is located.

**Name** - The name of the plug-in.

**Description** - (Optional) A short description to help you or another administrator identify this plug-in in the future.

**Implementation Class** - Choose the class from the menu that implements the plug-in interface. Applies to the Mobile Client Plug-in Configuration page, the Mobile Resource Server Plug-in Configuration page, and the Mobile Authorization & Consent Service Plug-in Configuration page. See the *Oracle Fusion Middleware Developer's Guide for Oracle Access Management* for details.

**Interface Class** - Lists the interface class for this plug-in. Applies to the Mobile Client Plug-in Configuration page, the Mobile Resource Server Plug-in Configuration page, and the Mobile Authorization & Consent Service Plug-in Configuration page.

**Security Handler Class** - Choose the Java class that defines the Security Handler Plug-in. Applies to the Mobile Adaptive Access Plug-in Configuration page and the Mobile Custom Token Attributes Plug-in Configuration page.

**Mobile Security Manager Plug-in Class** - Choose the Java class that defines the Mobile Security Manager Plug-in. Applies to the Mobile Security Manager Plug-in Configuration page only.

**MSM Device Inventory Attributes Precedence** - When enabled, if both the Mobile Security Manager (MSM) component and the Mobile OAuth server supply a value for the same device attribute, the value supplied by the Mobile Security Manager is used. If the attribute value from the MSM component is not available, the value from the Mobile OAuth server is used instead.

**MSM Attributes** - Lists the attributes that the Mobile Security Manager plug-in harvests from mobile devices. The first column lists the mobile device attributes that the Mobile Security Manager component collects. The second column lists the mobile device attributes that the Mobile OAuth server collects during mobile app requests. If the same device attribute is available from both the MSM component and the server, both are listed in the same row. (For example, the MSM attribute "imei" appears in column one, and the matching server attribute "oracle:idm:claims:client:imei" appears in column two of the same row.) For a list of the device attributes that the Mobile OAuth server collects during app requests, open the OAuth Mobile Client Configuration page and locate the **Device Claim Attributes** list in the **Configuration Settings** section. To add additional attributes, click **Add** to add a row at the bottom of the table, and enter the attribute name. (Enter attributes sourced from Mobile Security Manager in the first column, and attributes from the Mobile OAuth server in the

second column. Enter attributes one per row unless the attributes are equivalent and should be mapped to one another.)

**Attributes** - Use this section to define custom plug-in attributes.

### 53.3.9 Server Settings

You can configure general server settings for the identity domain named using the Server Settings Configuration page.

Use the Server Settings Configuration page to configure general server settings for the identity domain named.

---

---

**Note:**

See [Deployment Constraints for Mobile and Social](#) for information about deploying Mobile and Social with a WebGate.

---

---

**Identity Domain** - The name of the identity domain to which the settings on this configuration page apply. (Read-only)

#### HTTP Proxy Settings

Configure the following settings if a proxy server is in place between the OAuth Token Service (the Push Service) and the Apple Push Notification Service (APNS) or Google Cloud Messaging (GCM) service.

**Proxy URL** - Choose the protocol to use to connect to the proxy server (HTTP or HTTPS), then type the proxy server host name and port number.

**Proxy Authentication** - Type the user name and password required to authenticate with the proxy server.

#### Apple Push Notification

Configure the default values that should be used for this identity domain. Use the OAuth Mobile Client Configuration page to customize these settings on an app by app basis.

**Minimum Connection Pool Size** - Specifies the minimum number of connections in the connection pool.

**Maximum Connection Pool Size** - Specifies the maximum number of connections in the connection pool.

**Keep Alive** - The Apple Push Notification keep alive value in seconds.

#### Token Life Cycle Management

**Maximum Search Results** - Specify the maximum number of token entry search results that should be returned on the Token Life Cycle Management page.

#### Attributes

**Attributes** - Use this section to define custom attributes.

**Table 53-5 OAuth Server Settings Attributes**

Name	Value	Notes
wgAuthnUserHeader	OAM_REMOTE_USER	This attribute usage is optional. If an OAM Webgate is front ending/proxying requests to an OAuth server, set this attribute. The OAM Webgate sets the OAM_REMOTE_USER header to identify the authenticated user. If a deployment uses another header name instead of OAM_REMOTE_USER, then this attribute needs to be set with that header name.

### 53.3.10 Jailbreak Detection Policy

You can configure the Jailbreak Detection Policy using the user interface.

See [Jailbreak Detection Policy - OAuth Services](#) for introductory information about the jail breaking detection policy. The following section describes how to use the user interface to configure the policy.

**Jailbreak Detection** - Select **Enabled** to turn the Jailbreaking Detection Policy on, or clear this option to turn it off for all client application instances. If you enable the Jailbreaking Detection Policy here, you can disable it on an application by application basis. If you disable the Policy here, you cannot enable or disable the feature on an application by application basis.

#### Policy Statements

Use the buttons in the menu to add, delete, and re-order policy statements.

**Order** - The sequential row number assigned to each row in the table.

**Enabled** - Select this option to activate the policy statement condition.

**Minimum OS Version** - The minimum iOS version to which the policy applies. If the value is 1.0, the policy will apply to iOS devices running at least version 1.0 of iOS.

**Maximum OS Version** - The maximum iOS version to which the policy applies. If the value is empty, a maximum iOS version number is not checked so the policy applies to any iOS version higher than the value specified for Min OS Version. Once set you cannot remove the value and leave this field empty.

**Minimum Client SDK Version** - The minimum Mobile and Social Client SDK version number. For example, 11.1.2.0.0.

**Maximum Client SDK Version** - The maximum Mobile and Social Client SDK version number. For example, 11.1.2.3.0.

**Details** - Additional details about the Jailbreak Detection Policy policy statement. Hover the mouse over the info icon to view the details in a pop-up.

#### Policy Statement Conditions

Click to select a row in the table to view or edit its values in this section. See the previous section (Policy Statements) for field descriptions.



### Policy Statement Detection Logic

**Policy Expiration Duration** - Type the length of time in seconds that the SDK on the mobile client device should wait before expiring the local copy of the policy and retrieving a newer version.

**Auto Check Period** - Type the interval of time in minutes that the client device should wait before executing the Jailbreaking Detection Policy statements again.

**Detection Location** - The iOS client device uses a logical-OR operator to evaluate Policy statements. Add a Detection Location as follows:

- **File Path** - Type the absolute path to the file or directory on the device for which the Detection Policy should search.
- **Action** - Select **Exists** which instructs the Detection Policy to evaluate whether it can access a file path.
- **Success** - Select if the Policy should flag the device as jail broken if the specified files or directories are found on the device. Use this option if the policy is checking for unauthorized files or directories. Clear this option if the Policy should flag the device as jail broken if the specified files or directories are *not* found. (Use this option if checking for *required* files or directories.)

## 53.3.11 Token Life Cycle Management

You can use the Token Life Cycle Management page to search for and revoke tokens that have been issued.

You can search for tokens using criteria such as user ID, client ID/name, client IP address, service profile, assertion token category, and token creation/expiration time. Enter your criteria and click **Search**. The maximum number of token entry search results returned is determined by the **Maximum Search Results** setting on the OAuth Server Settings page.

### Search Criteria

**Identity Domain** - The name of the identity domain that you are searching for tokens. (Read only)

**User** - Specify an LDAP UID (`john.smith`) or an LDAP Fully Qualified DN (`cn=jane.smith,dc=example,dc=com`) to search by.

**Client** - Specify a client ID to search for tokens by.

**Client IP Address** - Specify a client IP address (for example, `192.168.100.1`) to search for tokens by

**Service Profile** - Choose a profile from the menu, or leave this selection empty.

**Assertion Token Category** - Choose a category from the menu, or leave this selection empty.

**Token Issued** - Search for tokens by the date and time that they were issued.

**Token Expiring at** - Search for tokens by the date and time that they expire.

### Mobile Device Claim Attributes

**IMEI** - Specify the unique 15-digit IMEI (International Mobile Equipment Identity) code to search by. The IMEI can be displayed on most mobile handsets by dialing `*#06#`.

**MAC Address** - Specify the unique MAC (Media Access Control) address to search by.

**Phone Number** - Specify a phone number to search by.

## 53.4 Configuring OAuth Services for Third-Party JWT Bearer Assertions

OAuth Services accepts third-party (non-Oracle) JWT assertions. You must, however, configure a trust relationship by adding the third-party's certificate into the OAuth Services Service Profile keystore. OAuth Services uses the keystore to verify the JWT assertion's digital signature.

Create a separate keystore for each Service Profile that needs its own signing certificate. This section covers the following topics:

- [Default Service Profile Keystore](#)
- [Creating a Non-Default Keystore for a Service Profile](#)
- [Configuring a Third-Party JWT Trust Issuer](#)

### 53.4.1 Default Service Profile Keystore

The default Service Profile (OAuthServiceProfile) created in the DefaultDomain uses the Java Keystore (JKS) included with Oracle Access Management.

The role of the Service Profile is described in [Service Profiles - Identity Federation and OAuth Services](#). The OAuthServiceProfile consists of the following files:

**Table 53-6 Default OAuth JKS Keystore File and Settings File**

File	Path
JKS keystore file	<code>\$DOMAIN_HOME/config/fmwconfig/default-keystore.jks</code>
Keystore settings file	<code>\$DOMAIN_HOME/config/fmwconfig/jps-config.xml</code>

**Note:**

Oracle Web Services Manager also uses the `default-keystore.jks` service. For details see [About the Oracle Web Services Manager Keystore \(default-keystore.jks\)](#).

You can use the following Java `keytool` command to list all of the private key and certificate information in the default keystore (`default-keystore.jks`).

```
keytool -list -keystore default-keystore.jks
```

**Note:**

When a new key is added to the OAM keystore, the OAM server needs to be restarted since keystore changes are not automatically refreshed.

## 53.4.2 Finding Credentials with Oracle Enterprise Manager Fusion Middleware Control Console

You can find the keystore credential with Oracle Enterprise Manager Fusion Middleware Control Console.

To find the keystore credential:

1. Login to the Oracle Enterprise Manager Fusion Middleware Control Console.  
`http://host_name.domain_name:port_number/em`
2. Navigate through WebLogic Domain --> <domain name>.  
<domain name> is the name of the domain in which the information is stored.
3. Click on the WeblogicDomain found in the right corner.
4. Select System MBean Browser ---> com.oracle.jps ---> Server:oam\_server1 ---> JPS Credential Store.
5. Navigate through JPS Credential Store Mbean --> Operations --> getPortableCredentialMap.
6. Enter the p1 parameter as oracle.wsm.security.
7. Click Invoke.
8. Expand Data Element2.  
The password value is displayed.

## 53.4.3 Creating a Non-Default Keystore for a Service Profile

You can create a non-default keystore for a Service Profile.

The steps in this section describe about:

- [Creating a Separate Keystore to Store Third-Party Certificates](#)
- [Loading or Importing the Certificates Into the Keystore](#)
- [Adding the Keystore Instance to jps-config.xml](#)
- [Creating a CSF Entry for the Keystore Service Instance](#)
- [Adding the Provider Service Name to the Service Profile](#)

---

---

**Note:**

Any changes made during this procedure require a restart of the OAM server.

---

---

### 53.4.3.1 Creating a Separate Keystore to Store Third-Party Certificates

You can create a new Java Keystore (JKS) using the `keytool` utility that is distributed with the Java JDK.

To create a new JKS:

1. Go to `$JDK_HOME/jdk/bin` and open a prompt.
2. Using `keytool`, generate a key pair:

```
keytool -genkeypair -keyalg RSA -dname dname
 -alias aliasname -keypass key_password -keystore keystore
 -storepass keystore_password -validity days_valid
```

Where:

- *dname* is the X.509 Distinguished Name to be associated with *alias*, and is used as the issuer and subject fields in the self-signed certificate. This can be any string as long as it's in the correct format (for example, `cn=spaces,dc=example,dc=com`).
- *aliasname* is a short name that identifies the new keystore entry
- *key\_password* is the password for the new public key
- *keystore* is the keystore name, (for example, `oauth-xyz-keystore.jks`)
- *keystore\_password* is the keystore password
- *days\_valid* is the number of days for which the certificate should be considered valid (for example, 1064).

Creating the Keystore

```
keytool -genkeypair -keyalg RSA -dname "cn=spaces,dc=example,dc=com"
 -alias oauthkey -keypass password123 -keystore oauth-xyz-keystore.jks
 -storepass passwordxyz -validity 1064
```

### 53.4.3.2 Loading or Importing the Certificates Into the Keystore

You can use the `keytool` utility to import the certificates into the keystore.

To import the certificates:

1. Using `keytool`, type the following command:

```
keytool -importcert -alias aliasname -file certfile
 -keystore keystore -storepass keystore_password
```

Where:

- *aliasname* is a short name that identifies the keystore
- *certfile* is the file containing the certificates to load
- *keystore* is the keystore name, (for example, `oauth-xyz-keystore.jks`)
- *keystore\_password* is the keystore password

Loading the Certificates

```
keytool -importcert -alias oauthkey_123 -file samplekey.cer -keystore oauth-xyz-
keystore.jks -storepass passwordxyz
```

### 53.4.3.3 Adding the Keystore Instance to `jps-config.xml`

You can configure the keystore service and update the credential store so that OAM can read the keystore and keys correctly.

In the `jps-config.xml` keystore settings file, add the following new keystore service instance in the `<serviceInstances>` element.

1. In a text editor, open the keystore settings file:

```
$DOMAIN_HOME/config/fmwconfig/jps-config.xml
```

2. Find the `<serviceInstances>` node for the keystore.provider Provider, and add the following:

```
<serviceInstance name="<service-instance-name>" provider="keystore.provider"
location="<keystore-location>">
 <property name="keystore.provider.type" value="db"/>
 <property name="keystore.sig.csf.key" value="sign-csf-key"/>
 <property name="keystore.enc.csf.key" value="enc-csf-key"/>
 <property name="keystore.csf.map" value="oracle.oauth.security"/>
 <property name="keystore.pass.csf.key" value="keystore-csf-key"/>
 <property name="keystore.type" value="JKS"/>
 <propertySetRef ref="props.db.1"/>
</serviceInstance>
```

Where:

- `service-instance-name` = Any service-instance-name
- `keystore-location` = Path to the keystore file

Update `jps-config.xml`

```
<serviceInstance name="oauth-xyz-keystore.db" provider="keystore.provider"
location="./oauth-xyz-keystore.jks">
 <property name="keystore.provider.type" value="db"/>
 <property name="keystore.sig.csf.key" value="sign-csf-key"/>
 <property name="keystore.enc.csf.key" value="enc-csf-key"/>
 <property name="keystore.csf.map" value="oracle.oauth.security"/>
 <property name="keystore.pass.csf.key" value="keystore-csf-key"/>
 <property name="keystore.type" value="JKS"/>
 <propertySetRef ref="props.db.1"/>
</serviceInstance>
```

3. Find the `<jpsContexts>` node and add the new service instance into the default context section. (Do not remove any pre-existing service instances.) The following example shows the addition of a `<serviceInstanceRef>` element with a `ref` to the `oauth-xyz-keystore.db` service instance (defined in the previous step).

Adding the new Service Instance

```
<jpsContexts default="default">
 <jpsContext name="default">
 <serviceInstanceRef ref="oauth-xyz-keystore.db"/>
 ... other serviceInstanceRef elements ...
 </jpsContext>
</jpsContexts>
```

#### 53.4.3.4 Creating a CSF Entry for the Keystore Service Instance

You can create the necessary Credential Store Framework (CSF) entries using the WLST commands.

Following are the WLST commands. Restart the server when you are done.

```
createCred(map="oracle.wsm.security", key="sign_csf_key",
user="alias_name", password=keystore_password, desc="Description
of the signing key credential")

createCred(map="oracle.wsm.security", key="enc_csf_key",
user="alias_name", password=keystore_password, desc="Description
of the encryption key credential")

createCred(map="oracle.wsm.security", key="keystore_csf_key",
user="oauth", password=keystore_password, desc="Description of
the keystore credential")
```

Where:

- *sign\_csf\_key* = the password for the signing key
- *alias\_name* = the alias name for the key
- *keystore\_password* = the keystore password
- *enc\_csf\_key* = the password for the encryption key
- *keystore\_csf\_key* = the password for the keystore

#### Creating Credential Store Entries

```
createCred(map="oracle.wsm.security", key="oauth-sign-csf-key", user="ms-oauth-key",
password=passwordxyz, desc="Signing key credential")
```

```
createCred(map="oracle.wsm.security", key="oauth-enc-csf-key", user="ms-oauth-key",
password=passwordxyz, desc="Encryption key credential")
```

```
createCred(map="oracle.wsm.security", key="keystore_csf_key", user="oauth",
password=passwordxyz, desc="Keystore credential")
```

#### 53.4.3.5 Adding the Provider Service Name to the Service Profile

You can apply the updated configuration to the Service Profile.

See [Creating a Service Profile](#) if you have not yet created an OAuth Service Profile for the third-party service.

1. Access the Identity Domains page as described in [Configuring OAuth Services Components in an Identity Domain](#) and click the identity domain to open it for editing.
2. Click the **Service Profiles** tab.
3. Click the Service Profile name in the table.
4. Expand the **Attributes** section.
5. Add the keystore service information you configured in Example 52–4, "Adding the new Service Instance" to the **Attributes** table using the `keystore.service` name. Refer to the following screen capture.

**Mobile OAuth Service Profile Configuration** Apply Revert

\*Required

Identity Domain: DefaultDomain

Name: OAuthServiceProfile

Description:

Service Enabled:

Service Provider: OAuthServiceProvider

\* Service Endpoint:

▶ User Store

▶ Plug-ins

▲ Attributes

Name	Value
jwt.CryptoScheme	RS512
jwt.Issuer	www.oracle.example.com
createdByDefault	true
msAlwaysShowLogin	true

▶ Mobile Service Settings

▶ Configuration Settings

### 53.4.4 Configuring a Third-Party JWT Trust Issuer

You can configure OAuth Services to support specific JSON Web Token (JWT) issuers.

All Trusted Issuers must be defined so the OAM Server can validate the token, the thumbprint (x5t) and the key identifier based on this configuration. If there is a trusted entry already available with the same claim, header values and alias name, that entry will be used.

1. Access the Identity Domains page as described in [Configuring OAuth Services Components in an Identity Domain](#) and click the identity domain to open it for editing.
2. Click the **Service Profiles** tab.
3. Click the Service Profile name in the table.  
In this example, OAuthServiceProfile.
4. Expand the **Configuration Settings** section and click the **Trusted Issuers** tab.
5. Configure the following and click Apply.
  - The certificate alias
  - The URL of the Trusted Issuer
  - The key identifier (KID) of the certificate alias.
  - The X.509 Certificate Thumbprint

[Figure 53-4](#) is a screenshot of the OAuth Services Service Profile Configuration Page where Trusted Issuers are defined under the Configuration Settings heading. Three Trusted Issuers are configured in it and the following is true of these configurations.

- If a request comes with an assertion in which the Trusted Issuer is "www.example1.com", the kid header is "mykey" and there is no x5t header, the runtime uses the certificate with the "trustpartner1" alias name.
- If a request comes with an assertion in which the Trusted Issuer is "www.example2.com", the value of the x5t header is "s7RzuzdIJrDyvMS9ntyvMS9ntZt" and there is no kid header, the runtime uses the certificate with the "trustpartner2" alias name.
- If a request comes with an assertion in which the Trusted Issuer is "www.example.corp.com", the value of the kid header is "corpkey" and the value of the x5t header is "cYJ4pHYJrDYvMS9ntZts7Rzuzdl", the runtime uses the certificate with the "trustpartner3" alias name.

**Figure 53-4 OAuth Services Service Profile Configuration Page**

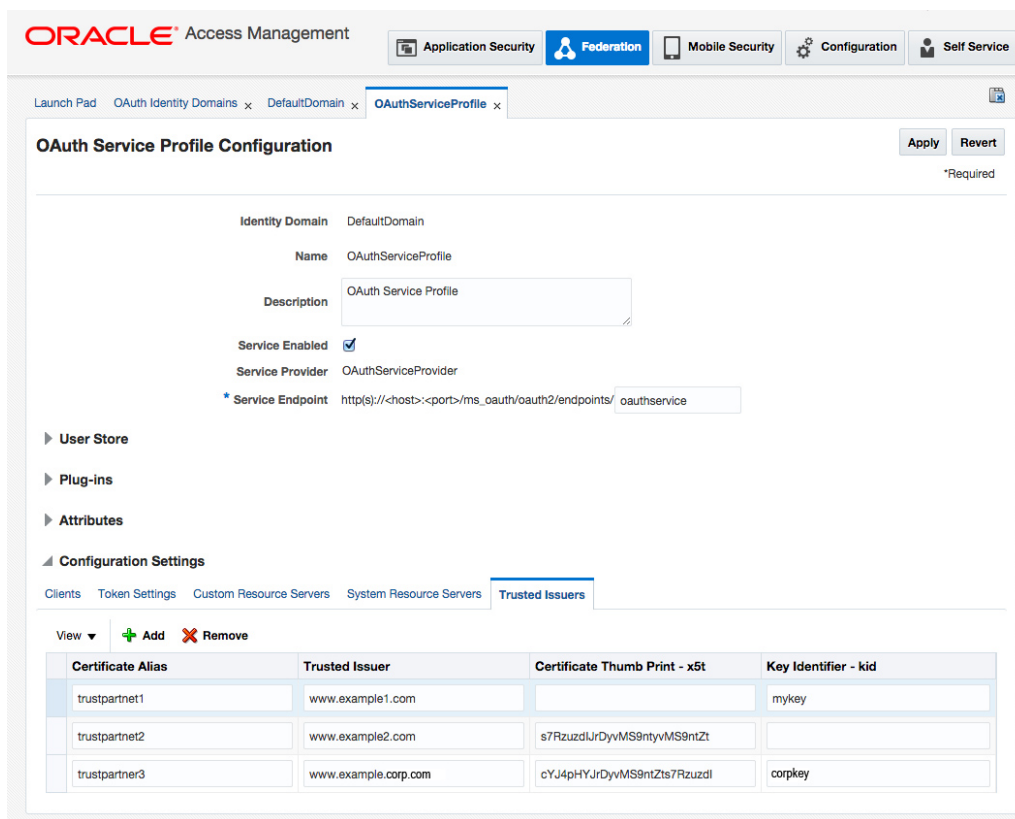

## 53.5 Configuring a WebGate to Protect OAuth Services

You can configure a WebGate for use with OAuth Services. The WebGate protects the OAuth Services consent page and serves as a proxy so that client authorization and token endpoint requests access the WebGate rather than the Oracle Access Management server directly.

WebGates cannot be used to protect OAuth Services Resource Servers. These steps are for WebLogic environments only.



**Note:**

A WebGate proxy is required to use the 3-legged authorization scenario with an external LDAP directory server.

1. Install the Oracle HTTP Server 11g Webgate for OAM using the instructions in *Installing Webgates for Oracle Access Manager*.
2. Configure the WebGate by defining the following resource and creating an authentication policy and authorization policy.
  - a. In the Oracle Access Management console, click **Application Security** at the top of the window.
  - b. Under **Access Manager**, click **Application Domains**, then click **Search** to view the Application Domains on the Search Application Domains page.
  - c. Click the target domain to open it for editing.
  - d. Select the **Resources** tab.
  - e. Create the following resource. If you are using the existing IAMSuiteAgent Host Identifier, the resource is already present and can be searched on using the **Resource URL** field.

```
/ms_oauth/oauth2/ui/**
```

Click to select the resource, then click the **Edit** button.

- f. Under the **Protection** heading, choose the following options from the menus and click **Apply**:

**Protection Level** - Protected

**Authentication Policy** - Protected HigherLevel Policy

**Authorization Policy** - Protected Resource Policy

These settings allow the Webgate to perform user authentication and user authorization.

- g. Add the following resources and set the **Protection Level** to **Excluded**:

```
/ms_oauth/oauth2/endpoints/**
/ms_oauth/oauth2/oammsui/**
/ms_oauth/style/**
/ms_oauth/img/**
/oam/**
```

The Webgate does not protect Excluded resources and allows them to be accessed.

3. Add the following lines to the `mod_wl_ohs.conf` file and restart the Webgate. For `WebLogicPort`, be sure to add the managed port details for your environment.

```
the following directive proxies all the OAuth requests
<IfModule weblogic_module>
 WebLogicHost host123.us.example.com
 WebLogicPort 17100
 Debug ON
```

```
WLogFile /tmp/weblogic.log
MatchExpression /ms_oauth/*
</IfModule>
the following directive proxies all the OAM managed server requests.

<IfModule weblogic_module>
 WebLogicHost host123.us.example.com
 WebLogicPort 17100
 Debug ON
 WLogFile /tmp/weblogic.log
 MatchExpression /oam/*
</IfModule>
```

4. Update the Access Manager Load Balancing settings as follows:
  - a. In the Oracle Access Management console, click **Configuration** at the top of the window.
  - b. Select **Access Manager** from the **View** menu in the **Settings** section.
  - c. In the **Load Balancing** section, change the **OAM Server Host** and the **OAM Server Port** settings to the Webgate's host and port settings.
  - d. Click **Apply**.

## 53.6 Configuring OAM Session Synchronization

The OAM User session synchronization feature prevents multiple OAM sessions from being created by a mobile user.

The initial OAM session is created during the 3-legged Mobile scenario when the authorization code is created (provided that the OAuth consent UI pages are protected by OAM). This session is stored in the device keystore and used for subsequent OAM token requests for as long as the session is valid.

A one-time Authorization Policy change in Oracle Access Management is required for OAM session synchronization to work. The following steps configure OAM to send Session ID values to OAuth Services. Once configured, OAM session synchronization will always be used for mobile authorization requests when using OAM protection (as opposed to Mobile and Social protection) for the authorization endpoint.

---

---

**Note:**

OAM Session Synchronization requires a WebGate protecting the OAuth Services consent UI pages. See [Configuring a WebGate to Protect OAuth Services](#) for details.

---

---

1. In the Oracle Access Management console, click **Application Security** at the top of the window.
2. Under **Access Manager**, click **Application Domains**.
3. Under **Search Application Domains**, enter the name of the target WebGate domain (or enter a partial name and wild card, \*, or leave the field blank to retrieve all domains). For example:

*DesiredDomain*

4. Click **Search**.

5. In the **Search Results** section, highlight the WebGate domain and click **Edit**.
6. Click the **Authorization Policies** tab.
7. In the policies table, click **Protected Resource Policy** to open it for editing.
8. Click the **Responses** tab.
9. Click **Add**.
10. Enter the following values in the **Add Response** dialog:
  - **Type** - choose **Header** from the menu.
  - **Name** - Enter any name, for example: *mysession*.
  - **Value** - Enter: `${session.id}`
 Click **Add**.
11. Click **Apply**.

## 53.7 Configuring Mobile OAuth for SSO Servlet Authentication

The Mobile OAuth SSO Servlet makes it possible to use a device-native app as a single sign-on proxy app when a user signs on to an app running in a mobile browser (external or embedded) in a 2-legged flow.

In this arrangement, the native app implements the login page and uses Mobile and Social Services to authenticate with Oracle Access Management. You can configure this authentication scheme to try multiple native apps on the device. If the first app does not respond within a half second (500ms) the servlet redirects the browser to the next app in the order that the apps are listed. If the servlet gets to the end of the list and there is not an application installed with the specified client ID, the servlet redirects the user to the OAM login page. Similarly, if the request is received from a desktop browser, the request is forwarded to the OAM login page.

Following is a description of the Mobile SSO Servlet authentication flow:

1. The user opens a URL in a mobile browser.
2. The web server hosting the application redirects the browser to OAM.
3. Access Manager redirects the browser to the native app on the device.
4. The browser launches the native app in response to the redirect.
5. The native app displays the user login page.
6. The user enters a user name and password.
7. The native app does a 2-legged device registration flow. It collects user credentials, does device registration, and gets the client token. If server-side single sign-on is enabled, the user token is stored on the server and is not returned to the client. If server-side single sign-on is turned off, the user token is returned to the client.
8. The native app exchanges the client token and user token for the OAM master token (OAM\_ID). (If server-side single sign-on is enabled, the user token is exchanged from the server-side keystore.)

9. The native app directs the browser to the Oracle Access Management Mobile and Social server, which injects the OAM master token as a cookie.
10. The native app sends the mobile browser a URL redirect and OAM master token as a cookie.
11. The mobile browser opens the original URL now that the access request includes an OAM master token.
12. The web server sends the requested pages to the mobile browser.

The following sections contain the configuration steps.

- [Configuring OAM and Your App to use the Mobile SSO Servlet](#)
- [Configuring the MobileSSOServlet Authentication Scheme](#)

For information about Mobile OAuth SSO options, see [Understanding Mobile OAuth Services Server-Side Single Sign-on](#).

### 53.7.1 Configuring OAM and Your App to use the Mobile SSO Servlet

You can configure OAM and your App to use the Mobile OAuth Services single sign-on authentication scheme.

You need to complete the following configuration tasks:

- In the Oracle Access Management console, protect the Web resource(s) with an OAM WebGate. To learn how, see [Registering and Managing OAM 11g Agents](#).
- In Access Manager, create a custom MobileSSOServlet authentication scheme on the OAM server and configure it with a list of mobile application IDs. Then configure the authentication scheme in OAM to protect the Web resource(s). To learn how, see [Configuring the MobileSSOServlet Authentication Scheme](#).
- If necessary, register the native mobile app client with Mobile OAuth Services. To register the native mobile app client with OAuth Services see [Configuring Clients](#).
- In Mobile OAuth Services, assign the **Resource Owner** grant type to the native mobile app(s) that will be configured to serve as single sign-on proxies. This grant type is required to be able to perform the 2-legged client registration.

To assign the client the **Resource Owner** grant type, use the OAuth Services Mobile Clients configuration page. For more information, see [Mobile Clients Configuration Page](#).

- To code the device-native app to authenticate with OAM using Mobile and Social Services, refer to the following sections in the *Oracle Fusion Middleware Developer's Guide for Oracle Access Management*:
  - For iOS, see "Invoking Authentication Services With the iOS Client SDK."
  - For Android, see "Invoking Authentication Services With the Android Client SDK."
  - For the REST API, see "Mobile and Social Services REST Reference: Authentication and Authorization."

When coding the app(s), implement the `/authenticate` endpoint, which is required to use this feature. This endpoint provides client registration, OAM token exchange, and URL redirection to the MobileSSOServlet. The /

authenticate endpoint should accept a resource URL (`resource_url`) and Return URL (`http://<OAM-HOST>:<OAM-PORT>/ms_oauth/mobilesso`) as parameters.

Once the app completes registration and the OAM token exchange, it returns control of the authentication process (along with the `OAM_ID` and `resource_url`) using the value of the `return_url` that was sent to `/authenticate` endpoint. Redirect the app back to the `MobileSSOServlet` using this URL:

```
/mobilesso?OAM_ID=1234&resource_url=http://<OAM-host>:7777/index.html
```

where:

- `OAM_ID` = the OAM master token value
- `resource_url` = URL of the resource

In this case, the redirect URL used to redirect the app back to the `MobileSSOServlet` will be `http://<OAM-HOST>:<OAM-PORT>/ms_oauth/mobilesso?OAM_ID=1234&resource_url=http://<OAM-host>:7777/index.html`

### 53.7.2 Configuring the MobileSSOServlet Authentication Scheme

You can configure a new authentication scheme (`MobileSSOServlet` authentication scheme) in Access Manager to protect the Web resource(s).

Use these steps to configure a new `MobileSSOServlet` authentication scheme:

1. Log on to the Oracle Access Management Administration Console.  
The Application Security Launch Pad opens.
2. Under **Access Manager** click **Authentication Schemes**, then click the **Create Authentication Scheme** button.

The "Create Authentication Scheme" tab opens.

3. Create a new Authentication Scheme by completing the form as follows:

- **Name:** MobileSSO-OAuth
- **Authentication Level:** 2
- **Challenge Method:** FORM
- **Challenge Redirect URL:** `/oam/server/`
- **Authentication Module:** LDAP
- **Challenge URL:** `/mobilesso`
- **Context Type:** `customWar`
- **Context Value:** `/ms_oauth/`
- **Challenge Parameters:**

```
applications=TestApp1,TestApp2
serviceEndPoint=oauthservice
```

Access Manager >

**Create Authentication Scheme** Authentication Scheme Set As Default Apply

An Authentication Scheme defines the challenge mechanism required to authenticate a user. Each Authentication Scheme must also include a defined Authentication Module.

\* Name

Description

\* Authentication Level

Default

\* Challenge Method

Challenge Redirect URL

\* Authentication Module

\* Challenge URL

\* Context Type

\* Context Value

Challenge Parameters

4. In the Oracle Access Management Administration Console, do the following:
  - a. Create a new Authentication Policy in an Application Domain and assign it the following Authentication Scheme:
 

**Authentication Scheme:** MobileSSO-OAuth

(*MobileSSO-OAuth* is the scheme that was created in step one.)
  - b. Create an HTTP Resource, for example `/mobileoauthapp`, and protect the resource using the created Authentication Scheme (MobileSSO-OAuth). This is the URI that will be accessed from the mobile web browser (mobile Safari for iOS) and protected by a WebGate.

## 53.8 Configuring the Mobile Security Manager Plug-in

You can configure Mobile Security Manager Plug-in, an optional plug-in for use with Oracle Mobile Security Suite (OMSS).

If you will be using Oracle Mobile Security Suite, see [OAuth Services Plug-ins](#) to learn more about this plug-in.

Before you use this plug-in, you must configure the MSM data source in Oracle Access Management. Complete these steps to change the target of the `omsm_ds` JDBC data source to `oam_server1`.

1. Log in to the WebLogic console:

```
http://host:port/console
```

2. Navigate to: `base_domain > Services > Data Sources`

3. In the **Data Sources** table, click omsm\_ds.
4. Click the **Targets** tab.
5. Select oam\_server1.





# Part XIII

---

## Managing Oracle Access Management Oracle Access Portal

Administrators manage the Access Portal Service, a hosted single sign-on proxy service that enables intranet and extranet applications with Oracle's form-fill single sign-on technology.

This section contains the following chapter:

- [Configuring the Access Portal Service](#)



---

## Configuring the Access Portal Service

The Access Portal Service is a hosted single sign-on proxy service that enables intranet and extranet applications with Oracle's form-fill single sign-on technology. It also provides the REST interfaces that implement the Web Logon Manager end-user web application.

Web Logon Manager, available as a standalone download from Oracle Support, provides end-users with the ability to create, modify, and delete application credentials as well as log on to provisioned applications through both desktop and mobile browsers.

The following topics describe how to configure the Access Portal service:

- [Prerequisites for Deploying the Access Portal Service](#)
- [Overview of the Access Portal Service Deployment Process](#)
- [Deploying the Access Portal Service](#)
- [Enabling Form-Fill Single Sign-On for an Application](#)
- [Adding a Federated Partner Provider Application](#)
- [Adding an Oracle SSO Agent Application](#)
- [Creating an Application Configuration Package](#)
- [Password Generation Policies](#)
- [Managing Credential Sharing Groups](#)
- [Managing Global Agent Settings](#)

### 54.1 Prerequisites for Deploying the Access Portal Service

Before completing the steps in this section, You must have already completed the following prerequisites before you start to deploy the Access Portal service.

See the documentation for the supporting software on how to configuring the software. The documentation is available on the Oracle Support web site.

- Install and configure an Oracle database instance
- Install and configure a supported repository (refer to the Certification Matrix for a list of supported repositories)
- Install and configure an instance of the WebLogic Administration server
- Install and configure an instance of Oracle Access Manager managed server

- Install the Oracle Enterprise Single Sign-On Administrative Console
- (Optional) If you're planning to use the Detached Credential Collector, install and configure an instance of Oracle HTTP Server

## 54.2 Overview of the Access Portal Service Deployment Process

The Access Portal Service provides form-fill single sign-on functionality to intranet and extranet Web applications by acting as a proxy between the target application and the user's browser.

Through the Oracle Traffic Director proxy, the Access Portal Service intercepts user connections to the target application, fetches the application's logon or password change page, and injects JavaScript code necessary to perform form-fill single sign-on tasks (such as credential capture or injection), then delivers the modified page to the user's browser.

The Access Portal Service utilizes the following components:

- **Oracle Traffic Director** - intercepts user connections to the target application and provides path-proxy and DNS-proxy functionality, allowing for path and DNS rewriting. Also hosts the WebGate plugin.
- **WebGate plugin** - a plugin that monitors whether the intercepted user connections require authentication via Oracle Access Manager (based on the assigned authentication policy) and redirects the user to the authentication page as necessary. It enables single sign-on functionality (logon, password change, and credential capture) in internal and external Web applications
- **Oracle Access Manager** - provides the authentication service to users as defined in the authentication policy.
- **An LDAP Directory** - serves as a data repository for the Access Portal Service and as the authentication back-end mechanism for Oracle Access Manager. For a list of supported directories, see the Certification Matrix accessible via the Oracle Support site.
- **(Optional) Web Logon Manager** - a reference client application that acts as a launchpad for applications enabled with Oracle's single sign-on technologies. Web Logon Manager supports Web applications enabled with the Access Portal Service's form-fill single sign-on technology and is available for download on the Oracle Technology Network web site. For more information, please contact Oracle Support.
- **Oracle Enterprise Single Sign-On Administrative Console** - provides the means to create and edit form-fill application policies (templates), password generation policies, delegate credentials, and configure other Access Portal Service features not accessible via the Oracle Access Manager Console.
- **(Optional) Oracle HTTP Server** - hosts the Detached Credential Collector Web pages.

The following is a high-level overview of the deployment process:

1. **Deploy the Java Cryptography Extension files on your Oracle Access Manager server.** These files enable unlimited strength jurisdiction policy encryption on Oracle Access Manager.

2. **Create the identity store configuration file.** This file contains the connection specifics for the directory that will host the Access Portal Service data repository.
3. **Prepare and enable the Access Portal Service.** You must use the IDM Configuration Tool to extend the directory schema, create the necessary users and groups, create the Webgate profile, create and assign an authentication scheme, and create a data repository; then, you must enable the Access Portal Service.
4. **Set the Oracle Access Manager policy cache refresh interval.** If you plan to use the Enterprise Single Sign-On Administrative Console to create and modify Access Portal Service application policies (templates), you must configure the Oracle Access Manager policy cache refresh interval to ensure that Oracle Access Manager periodically checks for updated policies in the Access Portal Service repository.
5. **(Optional) Install the Oracle Privileged Account Manager certificates.** If you plan to enable Oracle Privileged Account Manager-protected applications with the Access Portal Service, you must install the Oracle Privileged Account Manager certificates into the instance of Oracle Access Manager running the Access Portal Service. (Only supported on WebLogic.)
6. **Deploy the Oracle Traffic Director Administration Server instance.** This instance will provide the means to administrate Oracle Traffic Director proxy instance(s) (such as configuring listeners, origin servers, and server pools).
7. **Deploy the Webgate binaries and Oracle Access Manager secure trust artifacts.** You will run the Webgate installer to deploy the required plugin binaries into Oracle Traffic Director and copy the Oracle Access Manager secure trust artifacts into the deployed Webgate instance.
8. **(Optional) Deploy the ESSOProvisioning plugin.** This plugin enables provisioning of LDAP credentials as application credentials for single sign-on and the automatic updating of stored application credentials when the directory-provided credentials change. This plugin is optional and is not required by the Access Portal Service.
9. **Create an Oracle Traffic Director configuration.** An Oracle Traffic Director configuration is a collection of elements that define the run-time behavior of an Oracle Traffic Director instance. A configuration contains information about various elements of an Oracle Traffic Director instance such as listeners, origin servers, failover groups, and logs.
10. **Protect the Oracle Traffic Director instance with the Webgate plugin.** To allow the Webgate plugin to process user traffic and provide authentication and single sign-on services, you must place them "in front of" your Oracle Traffic Director instance. This is called "protecting" the instance with the selected plugins.
11. **(Optional) Enable the Detached Credential Collector for the Webgate.** The Detached Credential Collector adds a layer of security by intercepting user authentication requests normally sent directly to Oracle Access Manager, collecting the user's credentials, and passing them to Oracle Access Manager. This avoids the need for users to connect directly to your Oracle Access Manager instance. The Detached Credential Collector pages run on an instance of Oracle HTTP Server.
12. **Enable target applications for form-fill single sign-on.** Once the Access Portal Service has been successfully deployed, you can begin enabling your target

applications with form-fill single sign-on functionality. This includes configuring the necessary proxy rules in Oracle Traffic Director, and creating and publishing a form-fill application policy in Oracle Access Manager.

## 54.3 Deploying the Access Portal Service

The following topics describes how to configure the environment and deploy Access Portal:

- [Deploying Java Cryptography Extension Policy Files](#)
- [Identity Store Configuration File](#)
- [Oracle Access Manager Configuration File](#)
- [Understanding the Access Portal Service Repository Objects](#)
- [About Integrating with Oracle Privileged Account Manager](#)
- [Preparing and Enabling the Access Portal Service on an Oracle Repository](#)
- [Preparing and Enabling the Access Portal Service on Microsoft Active Directory](#)
- [\(Active Directory Only\) Deploying the OAMAgent Web Application](#)
- [About Integrating with Oracle Privileged Account Manager](#)
- [Deploying the Oracle Traffic Director Administration Server](#)
- [Deploying Webgate Binaries and Secure Trust Artifacts](#)
- [\(Optional\) Configuring the ESSOProvisioning Plugin](#)
- [Creating an Oracle Traffic Director Configuration](#)
- [Protecting the Oracle Traffic Director Instance with the Webgate Plugin](#)
- [\(Optional\) Enabling the Detached Credential Collector for the Target Webgate](#)

### 54.3.1 Deploying Java Cryptography Extension Policy Files

If you want to enable unlimited strength jurisdiction policy encryption on your Oracle Access Manager server, you must download the appropriate policy files and place them in the server's Java Runtime Environment.

To deploy Java Cryptography extension policy files:

1. Download the latest policy files from one of the following locations, depending on your Java Runtime Environment version:
  - **For Java 7:** <http://www.oracle.com/technetwork/java/javase/downloads/jce-7-download-432124.html>
  - **For Java 6:** <http://www.oracle.com/technetwork/java/javase/downloads/jce-6-download-429243.html>
  - **For IBM JDK on WebSphere:** <http://www.ibm.com/developerworks/java/jdk/security/60/>

2. Decompress the downloaded archive and place the `US_export_policy.jar` and `local_policy.jar` in `$JDK_Home/jre/lib/security/` within the target Java Runtime Environment (replace any existing files when prompted).
3. Reboot the Weblogic Administration Server and the Oracle Access Manager Managed Server.

### 54.3.2 Identity Store Configuration File

You can apply guidelines to create the `idstore.props` file that configures the identity keystore for the Access Portal Service.

You pass this file to the IDM Configuration Tool.

See [Preparing and Enabling the Access Portal Service on an Oracle Repository](#).

#### Oracle Unified Directory Example

```
Common
IDSTORE_HOST: IDMHOST1.mycompany.com
IDSTORE_PORT: 1389
IDSTORE_ADMIN_PORT: 4444
IDSTORE_KEYSTORE_FILE: OUD_ORACLE_INSTANCE/OUd/config/admin-keystore
IDSTORE_KEYSTORE_PASSWORD: Password key
IDSTORE_BINDDN: cn=oudadmin
IDSTORE_GROUPSEARCHBASE: cn=Groups,dc=mycompany,dc=com
IDSTORE_SEARCHBASE: dc=mycompany,dc=com
IDSTORE_USERNAMEATTRIBUTE: cn
IDSTORE_LOGINATTRIBUTE: uid
IDSTORE_USERSEARCHBASE: cn=Users,dc=mycompany,dc=com
IDSTORE_NEW_SETUP: true
POLICYSTORE_SHARES_IDSTORE: true
OAM
IDSTORE_OAMADMINUSER: oamadmin
IDSTORE_OAMSOFTWAREUSER: oamLDAP
OAM11G_IDSTORE_ROLE_SECURITY_ADMIN: OAMAdministrators
OAM and OIM
IDSTORE_SYSTEMIDBASE: cn=systemids,dc=mycompany,dc=com
OIM
IDSTORE_OIMADMINGROUP: OIMAdministrators
IDSTORE_OIMADMINUSER: oimLDAP
WebLogic
IDSTORE_WLSADMINUSER : weblogic_idm
IDSTORE_WLSADMINGROUP : WLSAdmins
```

#### Oracle Internet Directory Example

```
Common
IDSTORE_HOST: OIDHOST1.mycompany.com
IDSTORE_PORT: 3060
IDSTORE_BINDDN: cn=orcladmin
IDSTORE_GROUPSEARCHBASE: cn=Groups,dc=mycompany,dc=com
IDSTORE_SEARCHBASE: dc=mycompany,dc=com
IDSTORE_USERNAMEATTRIBUTE: cn
IDSTORE_LOGINATTRIBUTE: uid
IDSTORE_USERSEARCHBASE: cn=Users,dc=mycompany,dc=com
POLICYSTORE_SHARES_IDSTORE: true
IDSTORE_NEW_SETUP: true
OAM
IDSTORE_OAMADMINUSER: oamadmin
IDSTORE_OAMSOFTWAREUSER: oamLDAP
OAM11G_IDSTORE_ROLE_SECURITY_ADMIN: OAMAdministrators
```

```
OAM and OIM
IDSTORE_SYSTEMIDBASE: cn=systemids,dc=mycompany,dc=com
OIM
IDSTORE_OIMADMINGROUP: OIMAdministrators
IDSTORE_OIMADMINUSER: oimLDAP
WebLogic
IDSTORE_WLSADMINUSER : weblogic_idm
IDSTORE_WLSADMINGROUP : WLSAdmins
```

### Microsoft Active Directory Example

```
Common
IDSTORE_HOST: <AD-server-hostname>IDSTORE_PORT: <AD-server-
port>IDSTORE_DIRECTORYTYPE: adIDSTORE_BINDDN: <domain>\AdministratorIDSTORE_PASSWD:
<password>IDSTORE_USERNAMEATTRIBUTE: cnIDSTORE_LOGINATTRIBUTE: cn (or another login
attribute)>IDSTORE_USERSEARCHBASE:
CN=Users,DC=essodev,DC=idc,DC=localIDSTORE_SEARCHBASE:
DC=essodev,DC=idc,DC=localIDSTORE_GROUPSEARCHBASE:
CN=Users,DC=essodev,DC=idc,DC=localIDSTORE_SYSTEMIDBASE:
CN=Users,DC=essodev,DC=idc,DC=localIDSTORE_OAMSOFTWAREUSER:
oamSoftwareUserIDSTORE_OAMADMINUSER: oamAdminUserOAM11G_CREATE_IDSTORE:
trueESSO_IDSTORE_HOST : <AD-server-hostame>ESSO_IDSTORE_PORT : <AD-server-
port>ESSO_IDSTORE_BINDDN : <domain>\AdministratorESSO_IDSTORE_TYPE :
adIS_ESSO_PRESENT : trueESSO_IDSTORE_PASSWD : <password>
```

### Where:

- IDSTORE\_HOST and IDSTORE\_PORT are, respectively, the host and port of your Identity Store directory. Specify the back end directory here, rather than OVD. In the case of OID and OUD, specify, respectively, one of the Oracle Internet Directory or Oracle Unified Directory instances, for example:  
OID: OIHOST1 and 3060  
OUD: IDHOST1 and 1389
- IDSTORE\_ADMIN\_PORT (*LDAP\_DIR\_ADMIN\_PORT*) is the administration port of your Oracle Unified Directory instance. If you are not using Oracle Unified Directory, you can leave out this parameter.
- IDSTORE\_KEYSTORE\_FILE is the location of the Oracle Unified Directory Keystore file. It is used to enable communication with Oracle Unified Directory using the Oracle Unified Directory administration port. It is called *admin-keystore* and is located in *OUD\_ORACLE\_INSTANCE/OUD/config*. If you are not using Oracle Unified Directory, you can leave out this parameter. This file must be located on the same host that the *idmConfigTool* command is running on. The command uses this file to authenticate itself with OUD.
- IDSTORE\_KEYSTORE\_PASSWORD is the encrypted password of the Oracle Unified Directory keystore. This value can be found in the file *OUD\_ORACLE\_INSTANCE/OUD/config/admin-keystore.pin*. If you are not using Oracle Unified Directory, you can leave out this parameter. This file must be located on the same host that the *idmConfigTool* command is running on. The command uses this file to authenticate itself with OUD.
- IDSTORE\_BINDDN is an administrative user in the Identity Store Directory
- IDSTORE\_GROUPSEARCHBASE is the location in the directory where Groups are Stored.



- `IDSTORE_SEARCHBASE` is the location in the directory where Users and Groups are stored.
- `IDSTORE_USERNAMEATTRIBUTE` is the name of the directory attribute containing the user's name. Note that this is different from the login name.
- `IDSTORE_LOGINATTRIBUTE` is the LDAP attribute which contains the users Login name.
- `IDSTORE_USERSEARCHBASE` is the location in the directory where Users are Stored.
- `IDSTORE_NEW_SETUP` is always set to true for Oracle Unified Directory. If you are not using OUD, you do not need to specify this attribute.
- `POLICYSTORE_SHARES_IDSTORE` is set to `true` for IDM 11g.
- `IDSTORE_OAMADMINUSER` is the name of the user you want to create as your Access Manager Administrator.
- `IDSTORE_OAMSOFTWAREUSER` is a user that gets created in LDAP that is used when Access Manager is running to connect to the LDAP server.
- `OAM11G_IDSTORE_ROLE_SECURITY_ADMIN` is the name of the group which is used to allow access to the OAM console.
- `IDSTORE_SYSTEMIDBASE` is the location of a container in the directory where users can be placed when you do not want them in the main user container. This happens rarely but one example is the Oracle Identity Manager reconciliation user which is also used for the bind DN user in Oracle Virtual Directory adapters.
- `IDSTORE_OIMADMINGROUP` Is the name of the group you want to create to hold your Oracle Identity Manager administrative users.
- `IDSTORE_OIMADMINUSER` is the user that Oracle Identity Manager uses to connect to the Identity store.
- `IDSTORE_WLSADMINUSER`: The username to be used for logging in to the web logic domain once it is enabled by SSO.
- `IDSTORE_WLSADMINGROUP`: is the name of the group to which users who are allowed to log in to the WebLogic system components, such as the WLS Console and EM, belong.

Use OIM entries only if your topology includes Oracle Identity Manager. Use OAM entries only if your topology includes Access Manager.

### 54.3.3 Oracle Access Manager Configuration File

You can apply guidelines to create the `config-oam.props` file that configures the Oracle Access Manager instance.

You will pass this file to the IDM Configuration Tool in [Preparing and Enabling the Access Portal Service on an Oracle Repository](#). Note that the Access Portal Service requires the Simple mode security posture. To enable this posture, set the parameters below as follows:

```
OAM11G_OAM_SERVER_TRANSFER_MODE: simple
OAM_TRANSFER_MODE: simple
```

The file will have the following structure:

Create a properties file called `config_oam.props` with the following contents:

```
WLSHOST: ADMINVHN.mycompany.com
WLSPORT: 7001
WLSADMIN: weblogic
WLSPASSWD: Admin Password
IDSTORE_DIRECTORYTYPE: OUD
IDSTORE_HOST: IDSTORE.mycompany.com
IDSTORE_PORT: 389
IDSTORE_BINDDN: cn=oudadmin
IDSTORE_USERNAMEATTRIBUTE: cn
IDSTORE_LOGINATTRIBUTE: uid
OAM11G_SERVER_LOGIN_ATTRIBUTE: uid
IDSTORE_USERSEARCHBASE: cn=Users,dc=mycompany,dc=com
IDSTORE_SEARCHBASE: dc=mycompany,dc=com
IDSTORE_GROUPSEARCHBASE: cn=Groups,dc=mycompany,dc=com
IDSTORE_SYSTEMIDBASE: cn=systemids,dc=mycompany,dc=com
IDSTORE_OAMSOFTWAREUSER: oamLDAP
IDSTORE_OAMADMINUSER: oamadmin
PRIMARY_OAM_SERVERS: IDMHOST1.mycompany.com:5575, IDMHOST2.mycompany.com:5575
WEBGATE_TYPE: ohsWebgate11g
ACCESS_GATE_ID: Webgate_IDM
OAM11G_OIM_WEBGATE_PASSWD: password to be assigned to WebGate
COOKIE_DOMAIN: .mycompany.com
OAM11G_WG_DENY_ON_NOT_PROTECTED: true
OAM11G_IDM_DOMAIN_OHS_HOST: SSO.mycompany.com
OAM11G_IDM_DOMAIN_OHS_PORT: 443
OAM11G_IDM_DOMAIN_OHS_PROTOCOL: https
OAM11G_SERVER_LBR_HOST: SSO.mycompany.com
OAM11G_SERVER_LBR_PORT: 443
OAM11G_SERVER_LBR_PROTOCOL: https
OAM11G_OAM_SERVER_TRANSFER_MODE: simple
OAM_TRANSFER_MODE: simple
OAM11G_IDM_DOMAIN_LOGOUT_URLS: /console/jsp/common/logout.jsp,/em/targetauth/
emaslogout.jsp
OAM11G_IDSTORE_ROLE_SECURITY_ADMIN: OAMAdministrators
OAM11G_SSO_ONLY_FLAG: false
COOKIE_EXPIRY_INTERVAL: 120
OAM11G_IMPERSONATION_FLAG: false
OAM11G_OIM_INTEGRATION_REQ: false
OAM11G_OIM_OHS_URL:https://SSO.mycompany.com:443
SPLIT_DOMAIN:true
```

Where:

- `WLSHOST` (`ADMINVHN`) is the host of your administration server. This is the virtual name.
- `WLSPORT` is the port of your administration server.
- `WLSADMIN` is the WebLogic administrative user you use to log in to the WebLogic console.
- `WLSPASSWD` is the WebLogic administrator password.
- `IDSTORE_DIRECTORYTYPE` is OUD, OID or OVD.
- `IDSTORE_HOST` and `IDSTORE_PORT` are the host and port of the Identity Store directory when accessed through the load balancer.

- `IDSTORE_BINDDN` is an administrative user in the Identity Store directory.
- `IDSTORE_USERSEARCHBASE` is the location in the directory where Users are stored.
- `IDSTORE_GROUPSEARCHBASE` is the location in the directory where Groups are stored.
- `IDSTORE_SEARCHBASE` is the location in the directory where Users and Groups are stored.
- `IDSTORE_SYSTEMIDBASE` is the location of a container in the directory where the user `oamLDAP` is stored.
- `IDSTORE_OAMSOFTWAREUSER` is the name of the user account to be used to interact with LDAP.
- `IDSTORE_OAMADMINUSER` is the name of the user account that can access your OAM Console.
- `PRIMARY_OAM_SERVERS` is a comma separated list of your OAM Servers and the proxy ports they use, for example: `IDMHOST1:OAM_PROXY_PORT`

---

---

**Note:**

To determine the proxy ports your OAM Servers use:

1. Log in to the Oracle Access Management Console.
2. Click **Configuration** in the upper right corner.
3. Click **Server Instances**.
4. Search for the OAM Server, such as **WLS\_OAM1**, and select **Open** from the **Actions** menu.
5. Proxy port is the value shown as **Port**.

- 
- 
- `ACCESS_GATE_ID` is the name you want to assign to the WebGate.
  - `OAM11G_OIM_WEBGATE_PASSWD` is the password to be assign to the WebGate.
  - `OAM11G_IDM_DOMAIN_OHS_HOST` is the name of the load balancer which is in front of the OHS's.
  - `OAM11G_IDM_DOMAIN_OHS_PORT` is the port that the load balancer listens on (`HTTP_SSL_PORT`).
  - `OAM11G_IDM_DOMAIN_OHS_PROTOCOL` is the protocol to use when directing requests at the load balancer.
  - `OAM11G_WG_DENY_ON_NOT_PROTECTED`, when set to `false`, allows login pages to be displayed. It should be set to `true` when using `webgate11g`.
  - `OAM_TRANSFER_MODE` is the security model that the Oracle Access Manager Servers function in. Valid values are `simple` and `open`. If you use the `simple` mode, you must define a global passphrase.

- `OAM11G_OAM_SERVER_TRANSFER_MODE` is the security model that the OAM Servers function in.
- `OAM11G_IDM_DOMAIN_LOGOUT_URLS` is set to the various logout URLs.
- `OAM11G_SSO_ONLY_FLAG` configures Access Manager as authentication only mode or normal mode, which supports authentication and authorization.

If `OAM11G_SSO_ONLY_FLAG` is `true`, the OAM Server operates in authentication only mode, where all authorizations return true by default without any policy validations. In this mode, the server does not have the overhead of authorization handling. This is recommended for applications which do not depend on authorization policies and need only the authentication feature of the OAM Server.

If the value is `false`, the server runs in default mode, where each authentication is followed by one or more authorization requests to the OAM Server. WebGate allows the access to the requested resources or not, based on the responses from the OAM Server.

- `OAM11G_IMPERSONATION_FLAG` is set to `true` if you are configuring OAM Impersonation.
- `OAM11G_SERVER_LBR_HOST` is the name of the load balancer fronting your site. This and the following two parameters are used to construct your login URL.
- `OAM11G_SERVER_LBR_PORT` is the port that the load balancer is listening on (`HTTP_SSL_PORT`).
- `OAM11G_SERVER_LBR_PROTOCOL` is the URL prefix to use.
- `OAM11G_OIM_INTEGRATION_REQ` should be set to `true` if you are building a topology which contains both OAM and OIM. Otherwise set to `false` at this point. This value is only set to true when performing Access Manager/Oracle Identity Manager integration and is set during the integration phase.
- `OAM11G_OIM_OHS_URL` should be set to the URL of your load balancer. This parameter is only required if your topology contains OAM and OIM.
- `COOKIE_DOMAIN` is the domain in which the WebGate functions.
- `WEBGATE_TYPE` is the type of WebGate agent you want to create.
- `OAM11G_IDSTORE_NAME` is the Identity Store name. If you already have an Identity Store in place which you wish to reuse (rather than allowing the tool to create a new one for you), then set the value of this parameter to the name of the Identity Store you wish to reuse.
- `OAM11G_SERVER_LOGIN_ATTRIBUTE` when set to `uid`, ensures that when users log in, their username is validated against the `uid` attribute in LDAP.
- `SPLIT_DOMAIN` should be set to `true` If you are creating a domain with just OAM or OAM located in a different domain from OIM (Split Domain). Otherwise, it is not necessary to specify this parameter.

### 54.3.4 Understanding the Access Portal Service Repository Objects

The `vGoLocator` object is required for all repositories and the value of its `vGoLocatorAttribute` attribute specifies the path to the `People` container in which the Access Portal Service stores application credentials for each user.

The `vGoLocator` object must point to the same data store instance as the Oracle Access Manager instance on which the Access Portal Service is deployed.

For Oracle LDAP directories, the following applies:

- If there is a single object under the `vGoLocator` container, the `vGoLocatorAttribute` value is parsed regardless of the object's name.
- If there are multiple objects under the `vGoLocator` container, the object named `default` is parsed. If no object named `default` exists, the request will fail.
- If the `vGoLocatorAttribute` attribute has no value or does not exist, or if the `vGoLocator` container does not exist, the request will fail.

When using Microsoft Active Directory, the Access Portal Service stores application credentials under the `Users` container as described below:

- If there is a single object under the `vGoLocator` container, the `vGoLocatorAttribute` value is parsed regardless of the object's name.
- If there are multiple objects under the `vGoLocator` container, the object named `default` is parsed. If no object named `default` exists, the data will be within the `USERS` container.
- If the `vGoLocatorAttribute` attribute has no value or does not exist, or if the `vGoLocator` container does not exist, the data will be stored within the `Users` container.

You must explicitly enable the storage of user credentials under respective user objects using the Oracle Enterprise Single Sign-On Suite Administrative Console. This makes the following changes to the repository:

- The `User` class is added as a possible superior to the `vGOUserData` class.
- All users are granted the right to create `vGOUserData` objects. These rights are granted at the directory root and are recursively inherited down to the user objects.

### 54.3.5 Preparing and Enabling the Access Portal Service on an Oracle Repository

You can prepare and enable the Access Portal Service on an Oracle Repository.

Before completing this procedure, make sure you have created the required configuration files as described in [Identity Store Configuration File](#) and [Oracle Access Manager Configuration File](#).

The `idmConfigTool` is located at:

`IAM_ORACLE_HOME/idmtools/bin`

---

**Note:**

When you run the `idmConfigTool`, it creates or appends to the file `idmDomainConfig.param`. This file is generated in the same directory that the `idmConfigTool` is run from. To ensure that each time the tool is run, the same file is appended to, always run the `idmConfigTool` from the directory:

```
IAM_ORACLE_HOME/idmtools/bin
```

---

The syntax of the command on Linux is:

```
idmConfigTool.sh -configOAM input_file=configfile
```

For example:

```
idmConfigTool.sh -configOAM input_file=config_oaml.props
```

When the command runs you are prompted to enter the password of the account you are connecting to the Identity Store with. You are also asked to specify the passwords you want to assign to these accounts:

- `IDSTORE_PWD_OAMSOFTWAREUSER`
  - `IDSTORE_PWD_OAMADMINUSER`
1. On the machine running your target Oracle Access Manager instance, change into the following directory:

```
/Oracle/Middleware/Oracle_IDM1/idmtools/bin
```

2. Set the following environment variables:

```
setenv ORACLE_HOME /Oracle/Middleware/Oracle_IDM1
```

```
setenv MW_HOME /Oracle/Middleware
```

```
setenv JAVA_HOME JDKPath
```

(where *JDKPath* is the full path to the Java Development Kit used by the Oracle Access Manager instance)

3. Pre-configure the identity store to extend the directory schema with the required object classes by running the following command:

```
./idmConfigTool.sh -preConfigIDStore
input_file=idstore.props
```

where `idstore.props` is a property file containing configuration parameters specific to your environment. For information on assembling this file, see [Identity Store Configuration File](#).

4. Create the required users and groups by running the following command:

```
./idmConfigTool.sh -prepareIDStore mode=all
input_file=idstore.props
```

where `idstore.props` is a property file containing configuration parameters specific to your environment. For information on assembling this file, see [Identity Store Configuration File](#).

This command does the following:

- Adds the Access Portal Service object classes and attributes to the schema
  - Creates the CO, People, and vGoLocator containers (with create permissions only, including children). For more information on these containers, see [Understanding the Access Portal Service Repository Objects](#).
5. Create and configure the required Webgate profile by running the following command:  

```
./idmConfigTool.sh -configOAM input_file=config_oam.props
```

where `config_oam.props` is a property file containing configuration parameters specific to your environment. For information on assembling this file, see [Oracle Access Manager Configuration File](#).
  6. Add conditions to the Admin role in the Security Realm as follows:
    - a. Log in to the Weblogic Administration Server Console.
    - b. In the left pane of the console, click **Security Realms**.
    - c. On the "Summary of Security Realms" page, click **myrealm** under the Realms table.
    - d. On the "Settings" page for myrealm, click the **Roles & Policies** tab.
    - e. On the "Realm Roles" page, expand the **Global Roles** entry under the Roles table. This brings up the entry for Roles.
    - f. Click the **Roles** link to go to the Global Roles page.
    - g. On the "Global Roles" page, click the **Admin** role to go to the Edit Global Role page:
    - h. On the "Edit Global Roles" page, under Role Conditions, click **Add Conditions**.
    - i. On the "Choose a Predicate" page, select **Group** from the predicates list and click **Next**.
    - j. On the Edit Arguments Page, specify `OAMAdministrators` in the **Group Argument** field and click **Add**.
    - k. Click **Finish** to return to the "Edit Global Rule" page.  
The Role Conditions now show the `OAMAdministrators` Group as an entry.
    - l. Click **Save** to finish adding the Admin role to the `OAMAdministrators` Group.
  7. Check the log file for any errors or warnings and correct them. A file named `automation.log` is created in the directory where you run the tool.
  8. Restart the WebLogic Administration Server.
  9. Enable the Access Portal Service:
    - a. Log on to the Oracle Access Manager Console.
    - b. Select the **Launch Pad** tab.
    - c. In the **Configuration** section, click **Available Services**.

- d. In the screen that appears, click **Enable** next to **Access Portal Service**.

---



---

**Note:**

After you run `idmConfigTool`, several files are created that you need for subsequent tasks. Keep these in a safe location.

Two 11g WebGate profiles are created: `Webgate_IDM`, which is used for intercomponent communication and `Webgate_IDM_11g`, which is used by 11g Webgates.

The following files exist in the directory `ASERVER_HOME/output/Webgate_IDM_11g`. You need these when you install the WebGate software.

- `cwallet.sso`
- `ObAccessClient.xml`
- `password.xml`

Additionally, you need the files `aaa_cert.pem` and `aaa_key.pem`, which are located in the directory `ASERVER_HOME/output/Webgate_IDM`.

---



---

### 54.3.6 Preparing and Enabling the Access Portal Service on Microsoft Active Directory

You can prepare and enable the Access Portal Service on Microsoft Active Directory.

The following LDIF file is required to extend the Active Directory schema with Access Portal Service classes and attributes:

```
<ORACLE_HOME>/idmtools/templates/ad/esso_schema_extn.ldif
```

The file is a template file. Before you can proceed, you need to modify the values, such as domain names and paths to match the target environment.

To prepare and enable the Access Portal Service with Microsoft Active Directory:

1. Extend the Active Directory schema by running the following command on the server machine hosting the repository:
 

```
ldifde -i -f esso_schema_extn.ldif
```

 Upon completion, a message will confirm that importing data was successful:
2. Use the `ADSIEdit` tool to create containers named `CO`, `People`, and `vGoLocator` under the repository root.
3. Under the `vGoLocator` container, create an object named `default` of class `vGoLocatorClass` and set its attribute value to the DN of the container that holds the `People` container. For more information, see [Understanding the Access Portal Service Repository Objects](#).
4. Enable the storage of user credentials under user objects:
  - a. Launch the Oracle Enterprise Single Sign-On Suite Administrative Console and connect to the target repository.
  - b. In the Console, select **Enable Storing Credentials Under User Object (AD Only)** from the **Repository** menu.



- c. The Console displays a dialog informing you of the changes about to be made to your Active Directory schema. Click **OK**.
- d. Wait for a dialog confirming the changes to appear, then click **OK** to dismiss it.

---

**Note:**

Members of protected groups (i.e., users whose ACLs are governed by the AdminSDHolder object) will not be able to store credentials under their user objects until the AdminSDHolder ACL is updated with permissions required by this feature. See the guide *Deploying Logon Manager with a Directory-Based Repository* for instructions on how to remedy this issue.

---

5. Create the users in Active Directory if necessary.
6. Create a user data store:
  - a. Log on to the Oracle Access Manager console and click **Configuration** at the top of the page.
  - b. Click **User Identity Stores**.
  - c. In the screen that appears, click **Create** under **OAM ID Stores**.
  - d. In the dialog that appears, fill in the following required values, leaving the rest at their defaults:

Field	Value
Store Name	ESSOAuthnStore
Store Type	Microsoft Active Directory
Location	<i>ad-server-hostname;port</i>
Bind DN	<i>domain\username</i>
Password	<i>password</i>
Login ID Attribute	cn
User Search Base	Fully qualified DN of the Users container
Object Search Base	Fully qualified DN of the Groups container

7. Test the connection and correct any errors if necessary, then click **Apply**.
8. Update the LDAP authentication module:
  - a. Log on to the Oracle Access Manager console.
  - b. In the **Plugins** section, click **Authentication Plug-ins**.
  - c. In the **Access Manager** section, click **Authentication Modules**.
  - d. In the screen that appears, click **Search**.

- e. In the list of search results, select the **LDAPPlugin** module.
  - f. In the **Steps** tab, select the **stepUI** step.
  - g. In the **KEY\_IDENTITY\_STORE\_REF** field, enter the name of the user data store you created in step 5 of this procedure.
  - h. Repeat the above for the **stepUA** step.
  - i. Click **Save** to save your changes.
9. Create the identity data store (IDS) profile in Oracle Access Manager:
- a. Log on to the Oracle Access Manager console.
  - b. Click **Configuration** at the top of the page.
  - c. Click **User Identity Stores**.
  - d. In the **IDS Profile** section, click **Create Form Fill Application IDS Profile**.
  - e. In the form that appears, fill in the fields as follows:

<b>Field</b>	<b>Value</b>
Name	<i>meaningful profile name</i>
Description	<i>meaningful profile description</i>
Repository Options	<b>Create New</b>
Repository Name	meaningful repository name
Directory Type	<b>Microsoft Active Directory</b>
Host name	<i>Active Directory server host name</i>
Port	<i>Active Directory server port</i>
Bind DN	<i>domain/user name of repository account</i>
Bind password	<i>password of repository account</i>
Base DN	<i>fully qualified DN of the repository root</i>
User search base	<i>fully qualified DN of the Users container</i>
App template search base	<i>fully qualified DN of the CO (ESSO policy data) container</i>
Top search base	<i>fully qualified DN of the repository root</i>

- f. Test the connection, then click **Apply**.
10. Configure the relational mapping of users and groups:
- a. Edit the IDS profile you just created.
  - b. Select the **Entity Attributes** tab.

- c. Add the following new attributes, one at a time (adding multiple attributes at once is not supported):  
member, memberOf, distinguishedName
- d. Select the **Entities** tab.
- e. Under **Users**, enable the member, memberOf, and distinguishedName entity attributes.
- f. Set the **User Base**, **Group Base**, **Search Base**, and **Create Base** entities to the fully qualified DNs of the respective containers in the repository.
- g. Repeat steps e and f in the **Groups** section of the form.
- h. Select the **Relationships** tab.
- i. Configure the entity relationships as shown in the following illustration:

Name	From		Relation	To		Recursive
	Entity	Attribute		Entity	Attribute	
user_memberOfGr	Users	memberOf	Many -> Many	Groups	distinguishedName	<input type="checkbox"/>
group_memberOfGr	Groups	memberOf	Many -> Many	Groups	distinguishedName	<input checked="" type="checkbox"/>
groupMember_use	Groups	member	Many -> Many	Users	distinguishedName	<input checked="" type="checkbox"/>

This makes the following changes in the file `DOMAIN_HOME/config/fmwconfig/ids-config.xml`:

```
<Entity create="true" delete="true" idAttr="CN" modify="true" name="Users" search="true" type="user">
 <AttrRef defaultFetch="false" filter="none" name="CN"/>
 <AttrRef defaultFetch="false" filter="none" name="memberOf"/>
 <AttrRef defaultFetch="false" filter="none" name="description"/>
 <AttrRef defaultFetch="false" filter="none" name="displayName"/>
 <AttrRef defaultFetch="false" filter="none" name="distinguishedName"/>
</Entity>
<Entity create="true" delete="true" idAttr="CN" modify="true" name="Groups" search="true" type="group">
 <AttrRef defaultFetch="false" filter="none" name="CN"/>
 <AttrRef defaultFetch="false" filter="none" name="member"/>
 <AttrRef defaultFetch="false" filter="none" name="name"/>
 <AttrRef defaultFetch="false" filter="none" name="description"/>
 <AttrRef defaultFetch="false" filter="none" name="distinguishedName"/>
</Entity>

<EntityConfig name="ADProfile">
 <Attributes>
 <Attribute dataType="string" description="" name="OU" pwdAttr="false" readOnly="false"/>
 <Attribute dataType="string" description="" name="CN" pwdAttr="false" readOnly="false"/>
 <Attribute dataType="string" description="" name="vGOConfigData" pwdAttr="false" readOnly="false"/>
 <Attribute dataType="string" description="" name="vGOConfigType" pwdAttr="false" readOnly="false"/>
 <Attribute dataType="string" description="" name="vGOSecretData" pwdAttr="false" readOnly="false"/>
 <Attribute dataType="string" description="" name="vgoLocatorAttribute" pwdAttr="false" readOnly="false"/>
 <Attribute dataType="string" description="" name="orclaqi" pwdAttr="false" readOnly="false"/>
 <Attribute dataType="string" description="" name="uniqueMember" pwdAttr="false" readOnly="false"/>
 <Attribute dataType="string" description="" name="name" pwdAttr="false" readOnly="false"/>
 <Attribute dataType="string" description="" name="displayName" pwdAttr="false" readOnly="false"/>
 <Attribute dataType="string" description="" name="description" pwdAttr="false" readOnly="false"/>
 <Attribute dataType="string" description="" name="sAMAccountName" pwdAttr="false" readOnly="false"/>
 <Attribute dataType="string" name="member" pwdAttr="false" readOnly="false"/>
 <Attribute dataType="string" name="memberOf" pwdAttr="false" readOnly="false"/>
 <Attribute dataType="string" name="distinguishedName" pwdAttr="false" readOnly="false"/>
 </Attributes>

 <EntityRelations>
 <EntityRelation fromAttr="memberOf" fromEntity="Users" name="user_memberOfGroup" recursive="false" toAttr="distinguishedName" toEntity="Groups" type="ManyToMany"/>
 <EntityRelation fromAttr="memberOf" fromEntity="Groups" name="group_memberOfGroup" recursive="true" toAttr="distinguishedName" toEntity="Groups" type="ManyToMany"/>
 <EntityRelation fromAttr="member" fromEntity="Groups" name="groupMember_user" recursive="true" toAttr="distinguishedName" toEntity="Users" type="ManyToMany"/>
 </EntityRelations>
</EntityConfig>
</EntitiesConfig>
</IdentityDirectoryConfig>
```

## 11. Enable the IDS profile:

- a. Select the **Launch Pad** tab in the Admin console window.
- b. At the top of the page, click **Configuration**.

- c. In the **Settings** section, select **Access Portal Service** from the **View** drop-down list.
        - d. In the screen that appears, select the IDS profile you created earlier from the **IDS Profile** drop-down list.
        - e. Click **Apply**.
12. Add the Active Directory schema XML definition file to the IDS server configuration file:
  - a. Open the following file in a text editor:

```
DOMAIN_HOME/config/fmwconfig/ovd/ids/server.os_xml
```
  - b. Locate the `<schema check="true">` section and add the following line inside it:

```
<location>schema.ms.xml</location>
```
  - c. Save and close the file.
  - d. Restart the managed server instance to apply your changes.

### 54.3.7 (Active Directory Only) Deploying the OAMAgent Web Application

The OAMAgent web application provides the means to configure Access Control Lists within an Active Directory-based Access Portal Service repository via a web interface running on Microsoft Internet Information Server.

To deploy the OAMAgent web application, do the following:

1. Extract the OAMAgent.zip file (available in the Logon Manager folder of the Enterprise Single Sign-On Suite ZIP archive) into a directory.
2. Using the IIS Manager application, create a new IIS web site; when prompted, in the **Physical Path** field, enter the full path to the directory into which you extracted the OAMAgent.zip archive.
3. Edit the newly created web application's Web.config file as follows:
  - a. Add the following to the system.webServer section:

```
<configuration><system.webServer><httpHandlers><add type="ColumbiaWindowsAgent.Rest.AgentAcl, OAMAgent" path="ColumbiaWindowsAgent/V1/AgentAcl" verb="POST"/></httpHandlers> </system.webServer></configuration>
```
  - b. Add the following to the system.web section:

```
<compilation targetFramework="4.0"><assemblies><add assembly="Interop.ActiveDs, Version=1.0.0.0, Culture=neutral"/></assemblies></compilation>
```
  - c. Save and close the file.
4. In the IIS Manager application, navigate to **IIS Manager > Target Site > .NET Compilation > Assemblies** and ensure that the new assembly appears in the list of assemblies (i.e., that the Interop.ActiveDs.dll file appears in the web root directory).
5. Create a new handler mapping:

- a. In the IIS Manager application, navigate to **IIS Manager > Target Site > Handler Mappings** and click **Add Managed Handler** in the right-hand pane.
- b. In the dialog that appears, fill in the fields as follows and save your changes:

Field	Value
Path	ColumbiaWindowsAgent/V1/AgentAcl
Type	ColumbiaWindowsAgent.Rest.AgentAcl, OAMAgent
Name	OAMAgent

6. Enable 32-bit application support:
  - a. In the IIS Manager application, navigate to **IIS Manager > Application Pools**.
  - b. Right-click the target site and select **Advanced Settings** from the context menu.
  - c. Set the **Enable 32-bit Applications** option to **True** and save your changes.
7. Make the following site configuration changes:
  - a. In the IIS Manager application, navigate to **IIS Manager > Application Pools**.
  - b. Select the target site.
  - c. Set the **.NET Version** to **4.0**.
  - d. Set the **Identity** option to **LocalSystem**.
  - e. Save your changes.
8. In the IIS Manager application, select the host machine, click **Server Certificates**, and click **Import a Certificate**, and provide the path to a root CA certificate trusted by both the IIS server running the OAMAgent web application as well as the server running the target Access Portal Service instance.
 

Additionally, the Access Portal Service server must have a certificate signed by that CA in its keystore. That CA must also be present in the server's cacert file (trust store).
9. Create a https binding using the newly installed certificate:
  - a. In the IIS Manager application, right-click the target site and select **Edit Bindings** from the context menu.
  - b. Click **Add New Site Binding**.
  - c. Select **https** from the **Type** drop-down list.
  - d. Select the certificate you imported in step 8.
  - e. Click **Close**.
10. Enable SSL for the target site:
  - a. In the IIS Manager application, select the target site.



### 54.3.9 About Integrating with Oracle Privileged Account Manager

When you integrate with Oracle Privileged Account Manager, you need to be aware of the Privileged Account Manager templates and the Privileged Account Manager server URL.

Following are the issues:

- Only Oracle Privileged Account Manager templates of type "Privileged" are supported. Templates of type "Delegated" are not supported when created on the server side; creating such a template will result in unpredictable behavior.
- You must specify the Oracle Privileged Account Manager server URL in the Access Portal Service settings in the target Oracle Access Manager server instance.

#### 54.3.9.1 Installing Oracle Privileged Account Manager Certificates

You must import the certificates into the identity keystore of the application server running the Oracle Access Manager instance.

This procedure is currently only available for WebLogic; do not perform it on other application servers.

---



---

**Note:**

The `listCred` command in OPSS has been deprecated in this release; keystore passwords must now be retrieved programmatically.

---



---

To install Oracle Privileged Account Manager:

1. Obtain the location and name of the identity keystore by examining the value of the following environment variables in the WebLogic console (where *OAMServerName* is the name of the target Oracle Access Manager instance):

```
environment-servers-OAMServerName-keystores
environment-servers-OAMServerName-ssl
```

2. Import the certificate into the identity keystore using the following command:

```
keytool -importcert -alias CertificateAlias -file CertificateName.crt -
keystore ./IdentityStoreName.jks -storepass IdentityStorePassword
```

where *CertificateAlias* is a meaningful alias you want to assign to the certificate for identification, *CertificateName* is the name of the certificate file, *IdentityStoreName* is the name of the target identity store and *IdentityStorePassword* is the password for that identity store.

3. Obtain the location and name of the CA certificate by examining the value of the following environment variable via the WebLogic console:

```
environment-servers-oam_server1-keystores
```

4. Import the CA certificate into the identity keystore using the following command:

```
keytool -importcert -alias CertificateAlias -file CertificateName.der -
keystore ./cacerts -storepass IdentityStorePassword
```

where *CertificateAlias* is a meaningful alias you want to assign to the certificate for identification, *CertificateName* is the name of the certificate file, *IdentityStoreName* is the name of the target identity store and *IdentityStorePassword* is the password for the cacerts identity keystore.

5. Export the target Oracle Access Manager domain's private key certificate (used for generating the SAML assertion) using the following command:

---



---

**Note:**

If a keystore type is not explicitly specified in the embedded trust provider configuration section of the following file:

*OAMDomainHome*/config/fmwconfig/jps-config.xml

then the Oracle Key Store Service keystore type is assumed.

If no application stripe name is specified for that KSS keystore, the service defaults to the following location:

*OAMDomainHome*/config/fmwconfig/default-keystore.jks

---



---

```
keytool -export -alias orakey -file orakey.der -keystore ./
IdentityStoreName.jks -storepass IdentityStorePassword
```

where *IdentityStoreName* is the name of the target identity store and *IdentityStorePassword* is the password for that identity keystore.

6. Change to the following directory:

*OPAMDomainHome*/config/fmwconfig

7. Import the target Oracle Access Manager domain's private key into the target Oracle Privileged Account Manager domain using the following command:

```
keytool -importcert -alias orakey -file orakey.der -
keystore ./IdentityStoreName.jks -storepass IdentityStorePassword
```

where *IdentityStoreName* is the name of the target identity store and *IdentityStorePassword* is the password for that identity keystore.

8. Restart the affected Oracle Access Manager instance and the affected Oracle Privileged Account Manager instance.

### 54.3.9.2 Configuring the Oracle Privileged Account Manager Server

You can configure the Oracle Privileged Account Manager server.

Before completing the steps below, make sure you have created a provider on the target Oracle Access Manager instance for the desired Oracle Privileged Account Manager instance and placed it as the first provider in the provider list.

To configure the Oracle Privileged Account Manager server:

1. Create a target with the following parameter values:

---

Field	Value
Storage Type	<i>Deployed repository type</i>

---



Field	Value
Server	<i>Hostname:port of the repository server</i>
Root DN	<i>Fully qualified DN of the repository root</i>
User Path	<i>Fully qualified DN of the Users container</i>
Connect as User	<i>CN of the repository connection account</i>
Password	<i>Password of the repository connection account</i>
Use secure connection (SSL)	Disabled
Use configuration objects instead of application list	Enabled
Role/Group support	Enabled
Configuration and role/group objects root DN	<i>Fully qualified DN of the CO container</i>
Admin Group DN	(not applicable; leave blank)
User Name Prepend	UID

2. Search for targets and click the target you created in step 1.
3. Click the **Privileged Accounts** tab.
4. In the **Privileged Accounts** tab, add the desired privileged account (stored on the target you created in step 1).
5. Add the desired grantees to the privileged account.
6. Restart both the admin and the privileged Oracle Privileged Account Manager server instances to apply your changes.

#### 54.3.9.3 Creating the Required Template Mapping on the Provisioning Gateway Server

You can create the required template mapping on the Provisioning Gateway server machine using Provisioning Gateway Administrative Console.

To create:

1. Run the following command on the Provisioning Gateway server machine:
 

```
certutil -setreg chain\minRSAPubKeyBitLength 512
```
2. Restart the Provisioning Gateway server machine.
3. Log on to the Provisioning Gateway Administrative Console.
4. Select the **Settings** tab, then the **Template Mapping** section.
5. Click **Edit** and select the privileged template associated with your Oracle Privileged Account Manager target, then save your changes. This will create the required `cn=OpamTemplateMap` mapping in the repository.
6. Test the configuration:

- a. Log on to Web Logon Manager as one of the grantees assigned to the target privileged account.
- b. Click **Add** next to the target privileged template. The privileged account details will appear in a separate tab.

### 54.3.10 Deploying the Oracle Traffic Director Administration Server

The Oracle Traffic Director Administration Server deploys and manages Oracle Traffic Director proxy instance(s).

Linux security restricts the opening of ports under 1024 to the `root` user. If you wish to run Oracle Traffic Director proxies on ports 80 or 443, follow the configuration guidelines for running as the `root` user.

See "Creating an Administration Server and Administration Node" in the *Oracle Traffic Director Installation Guide*.

---

---

**WARNING:**

Oracle highly recommends against running Oracle Traffic Director as the `root` user due to increased security risk; you should limit the use of the `root` user to development environments only.

---

---

To deploy the Oracle Traffic Director Administration Server:

1. Start the installation:

```
./<OTD-installer>/runinstaller
```

2. In the screen that appears, click **Next**.
3. In the next screen, check for and install any applicable updates.
4. In the screen that appears, set the Oracle Traffic Director home directory to the following and click **Next**:

```
/OTD11g/trafficdirector_Home_1
```

5. Wait for the installation to complete, then change into the following directory:

```
/OTD11g/trafficdirector_Home_1/bin
```

6. Create an Oracle Traffic Director administration server instance using the following command (only include `--server-user=root` if you want to run the server as the `root` user):

```
./tadm configure-server --user=admin --host=otd.hostname --
server-user=root --instance-home=/OTD11g/
trafficdirector_Home_1/instances
```

Oracle recommends using the default port (8989) for the Oracle Traffic Director administration server.

7. Start the Oracle Traffic Director administration server with the following command:

```
./OTD11g/trafficdirector_Home_1/instances/admin-server/bin/
startserv
```

8. Log on to the Oracle Traffic Director Admin Console at the following URL:

```
https://otd.hostname:8989
```

See the *Oracle Traffic Director Installation Guide*.

### 54.3.11 Deploying Webgate Binaries and Secure Trust Artifacts

You must have already created a Webgate profile in the Oracle Access Manager server before you start to deploy Webgate binaries and secure trust artifacts.

The secure trust artifacts that is generated during the procedure are required to complete the deployment of Webgate binaries and secure trust artifacts.

See [Preparing and Enabling the Access Portal Service on an Oracle Repository](#).

To deploy Webgate binaries and secure trust artifacts:

1. Decompress the Webgate binaries installer into a local directory on the Oracle Traffic Director host and launch the installer with the following command:

```
./runInstaller
```

2. When prompted, specify the full path to your Java runtime environment. For example: `/usr/local/packages/jdk16`

3. In the installer's "Prerequisite Checks" screen, click **Next**.

4. Specify the installation path and click **Next**:

```
/MW_HOME/OAM_OTD_WebGate_HOME
```

5. Click **Install** and wait for the installation to complete.

6. Change into the following directory:

```
/MW_HOME/OAM_OTD_WebGate_HOME/webgate/iplanet/tools/
deployWebGate
```

7. Deploy the Webgate binaries using the following command:

```
./deployWebGateInstance.sh -w /MW_HOME/wginst1 -oh /MW_HOME/
OAM_OTD_WebGate_HOME -ws otd
```

8. Copy the Oracle Access Manager artifact files (generated while completing the following steps):

See [Preparing and Enabling the Access Portal Service on an Oracle Repository](#):

- Copy the `ObAccessClient.xml`, `cwallet.sso`, and `password.xml` artifact files to:

```
/MW_HOME/wginst1/webgate/config
```

- Copy the `aaa_key.pem` and `aaa_cert.pem` artifact files to:

```
/MW_HOME/wginst1/webgate/config/simple
```

9. (Optional) If you deployed your Oracle Traffic Director administration server instance as the root user, grant that instance permissions to the Webgate (otherwise, skip this step).

---

**WARNING:**

Oracle highly recommends against running Oracle Traffic Director instances as the `root` user due to increased security risk; you should limit the use of the `root` user to development environments only.

---

- a. Change into `/MW_HOME/wginst1`
- b. Execute `chmod -R 777 .`

### 54.3.12 (Optional) Configuring the ESSOProvisioning Plugin

When you successfully log on to Oracle Access Manager, the `ESSOProvisioning` plugin will provision your directory credentials to a specific application in your Access Portal Service (ESSO) wallet.

It will also update the target application credentials if your directory credentials change. If you want to enable the plugin, you must assign the `ESSOProvAuthnScheme` to the `ESSOAuthnPolicy` authentication policy in the **IAM Suite** application domain profile.

To optionally configure the `ESSOProvisioning` plugin:

1. Log into the Oracle Access Manager Console.
2. At the top of the page, click **Application Security**.
3. In the **Plug-ins** section, click **Authentication Modules**.
4. In the screen that appears, click **Search**.
5. In the list of search results, click the `ESSOProvisioningModule` module.
6. In the screen that appears, select the **Steps** tab.
7. Edit the `ESSO_PROV_Step` step and enter the name of the target application for which you want to provision directory credentials.
8. Edit the `ESSO_UI_Step` and `ESSO_UA_Step` steps and add a **User Identity Store** value of `KEY_IDENTITY_STORE_REF` to each.
9. Click **Save** to save the steps, then click **Apply** to apply your changes to the module.
10. Select the **Launch Pad** tab; in the **Access Manager** section, click **Application Domains**.
11. In the screen that appears, click **Search**.
12. From the list of search results, locate and double-click the **IAM Suite** profile.
13. Select the **Authentication Policies** tab.
14. In the list of policies, select `ESSOAuthnPolicy`.
15. From the **Authentication Scheme** drop-down menu, select the `ESSOProvAuthnScheme` authentication scheme.
16. Click **Apply** to save your changes.

### 54.3.13 Creating an Oracle Traffic Director Configuration

You can create an Oracle Traffic Director Configuration

To create an Oracle Traffic Director configuration:

1. Log on to the Oracle Traffic Director Admin Console at the following URL:

```
https://otd.hostname:8989
```

2. Create a new Oracle Traffic Director configuration with the following parameters:

- **Name:** *a descriptive name for the configuration*
- **Server User:** *leave at the default value, unless you deployed the Oracle Traffic Director administration server as root*
- **Select Origin Server Type:** HTTP

3. Create a listener (your Oracle Traffic Director instance will listen for requests from the user's browser on this port) with the following parameters:

- **Port:** 8282
- **ServerName:** *otd.hostname*

4. Create an origin server pool with the following parameters:

- Add your target application host as *applicationHostname:port*
- Select the target node as *applicationHostname*

5. Click the **Instance** node in the tree on the left and start the instance.

6. Test the page by accessing the following URL and logging on with your administrator credentials:

```
http://otd.hostname:8282/target_webgate_profile
```

### 54.3.14 Protecting the Oracle Traffic Director Instance with the Webgate Plugin

To protect your Oracle Traffic Director instance with the Webgate plugin:

1. [Generating Secure Trust Artifacts](#)
2. [Loading Required WebGate Libraries into an OTD Instance](#)
3. [Deploying Configuration Changes](#)
4. [Testing the WebGate](#)

#### 54.3.14.1 Generating Secure Trust Artifacts

You can generate secure trust artifacts.

To generate:

1. Go to the following directory:

```
/MW_HOME/OAM_OTD_WebGate_HOME/webgate/iplanet/tools/setup/InstallTools
```

2. Set the LD\_LIBRARY\_PATH variable:

```
bash export LD_LIBRARY_PATH=/MW_HOME/OAM_OTD_WebGate_HOME/lib
csh setenv LD_LIBRARY_PATH /MW_HOME/OAM_OTD_WebGate_HOME/lib
```

3. Run the following command to modify the `magnus.conf` file to include the directives to load the `webgate` library into the Oracle Traffic Director instance as well as modify the associated Oracle Traffic Director configuration file to include the directives to activate the two plugins.

```
./EditObjConf -f /OTD11g/trafficdirector_Home_1/instances/
targetInstance/config/targetOTDconfiguration.conf -oh /MW_HOME/
OAM_OTD_WebGate_HOME -w /MW_HOME/wginst1 -ws otd -enableESSO
-enableWLM
```

---

**Note:**

Only include the `-enableWLM` flag if you have deployed the Access Portal reference application. Otherwise, the flag is not necessary.

If you do not include the `-enableWLM` flag and wish to deploy the Access Portal reference application later, you must manually modify the appropriate Oracle Traffic Director configuration file as described in the Access Portal reference application deployment instructions.

---

#### 54.3.14.2 Loading Required WebGate Libraries into an OTD Instance

You can load the required WebGate libraries into an OTD instance

To load:

1. Go to the following directory:

```
/OTD11g/trafficdirector_Home_1/instances/
targetOTDConfiguration/bin
```

2. Edit the `startsrv` script in a text editor and add the Webgate library path to the `LD_LIBRARY_PATH` variable as follows:

```
LD_LIBRARY_PATH="${SERVER_LIB_PATH}:/MW_HOME/
OAM_OTD_WebGate_HOME/lib:${SERVER_JVM_LIBPATH}:" ;
{LD_LIBRARY_PATH} " ;
```

#### 54.3.14.3 Deploying Configuration Changes

You can deploy configuration changes from the Oracle Traffic Director Admin Console.

To deploy:

1. Log into the Oracle Traffic Director Admin Console.
2. Select your configuration and click the **Instance Modified** notification at the top of the page.
3. Pull and deploy the changes.
4. When prompted to restart the instance, click **OK**, then click **Finish**.

#### 54.3.14.4 Testing the WebGate

You can test the WebGate by logging in using your repository credentials.

To test the WebGate:

1. Navigate to `http://otd.hostname:8282/target_webgate`
2. Log into the Webgate using your repository credentials.

If the target application does not appear, check your configuration for errors.

3. After successful configuration, if Access Portal service does not capture application credentials and autologin user, you must add the following parameters in OTD Webgate Agent Configuration: `TunnelUrl=/wlm,/idaas`

#### 54.3.15 (Optional) Enabling the Detached Credential Collector for the Target Webgate

You can enable the Detached Credential Collector for the target Webgate and deploy the Detached Credential Collector pages on Oracle HTTP Server.

The following topics describe how to enable and deploy the Detached Credential Collector:

- [Enabling Detached Credential Collector Operations](#)
- [Creating and Applying a Detached Credential Collector Authentication Scheme](#)
- [Deploying Detached Credential Collector Pages on an Oracle HTTP Server](#)
- [Routing Oracle Traffic Director Authentication Requests through a Detached Credential Collector](#)

##### 54.3.15.1 Enabling Detached Credential Collector Operations

You can enable detached credential collector operations from the **Application Security** launch pad.

To enable:

1. Login to the Oracle Access Management Console.
2. Select **Application Security** and in the **Launch Pad**, click **Agents** icon.
3. In the screen that appears, click **Search**.
4. From the list of search results, locate and click the agent that is protecting your OTD Proxy Instance.
5. Check the box **Allow Credential Collector Operations**.
6. Click **Apply** to save your changes.
7. Restart the OTD Proxy Instance.

##### 54.3.15.2 Creating and Applying a Detached Credential Collector Authentication Scheme

You can create and apply a detached credential collector authentication scheme from the **Application Security** launch pad.

To create:

1. Login to the Oracle Access Management Console.
2. Select **Application Security** and in the **Launch Pad**, click **Authentication Schemes** under Access Manager.
3. In the screen that appears, click **Search**.
4. From the list of search results, locate and click the **ESSOProvAuthnScheme** authentication scheme.
5. In the screen that appears, click **Duplicate**.
6. Give the new scheme a descriptive name - for example DCC-ESSOAuthnScheme.
7. In the **Challenge Method** drop-down list, select **FORM**.
8. In the **Challenge Redirect URL** field, enter the Oracle Traffic Director host name and port in the format `http://otd.hostname:port/` (including the trailing slash).
9. In the **Challenge URL** field, enter `/oamssso-bin/login.pl`
10. In the **Context Type** drop-down list, select **external**.
11. Click **Apply** to save your changes.
12. Select the **Launch Pad** tab.
13. In the **Access Manager** section, click **Application Domains**.
14. In the screen that appears, click **Search**.
15. From the list of search results, locate and click the **IAM Suite** profile.
16. Select the **Authentication Policies** tab.
17. Click **ESSOAuthnPolicy**.
18. In the **Authentication Scheme** drop-down list of **ESSOAuthnPolicy**, select the DCC authentication scheme you just created.
19. Click **Apply** to save your changes.

### 54.3.15.3 Deploying Detached Credential Collector Pages on an Oracle HTTP Server

You can deploy Detached Credential Collector pages on an Oracle HTTP server.

To deploy:

1. Enable CGI on the target instance of Oracle HTTP Server if you have not already done so.

Your `httpd.conf` should contain the following directive:

```
LoadModule cgi_module modules/mod_cgi.so
```

2. Copy the `oamssso` directory from the following location:

```
$WG_ORACLE_HOME/webgate/iplanet/
```

To the following location:

```
$OHS_INSTANCE_DIR/config/OHS/ohs1/htdocs
```



3. Copy the `oamssso-bin` directory from the following location:

```
$WG_ORACLE_HOME/webgate/iplanet/
```

To the following location:

```
$OHS_INSTANCE_DIR/config/OHS/ohs1/
```

4. Locate the `<IfModule alias_module>` block in the `httpd.conf` file.
5. Enable CGI for the following block into the `<IfModule alias_module>` block:

```
ScriptAlias /oamssso-bin/ "${ORACLE_INSTANCE}/config/ ${
COMPONENT_TYPE}/${COMPONENT_NAME}/oamssso-bin/ "
```

6. Restart the OHS instance.
7. Test your configuration by accessing the following URL:

```
http://ohs.host:port/oamssso-bin/login.pl
```

#### 54.3.15.4 Routing Oracle Traffic Director Authentication Requests through a Detached Credential Collector

You can route Oracle Traffic Director Authentication requests through a detached credential collector and test your configuration using application's proxy URL.

To route:

1. Under your target Oracle Traffic Director configuration, create a new origin server pool that points to the Oracle HTTP Server hostname and port.
2. Create a new route that points to the origin server pool created in step 1.
3. Add the following URI condition to the route:

```
/oamssso-bin OR /oamssso
```

4. Save your changes and restart the Oracle Traffic Director instance.
5. Test your configuration by accessing the target application's proxy URL.

#### 54.3.16 Configuring Logon Manager for Compatibility with the Access Portal Service

You can enable interoperability between Logon Manager and the Access Portal Service.

If you have not already done so, install the Authentication Manager component of the Logon Manager on each target end-user machine to enable the MultiAuth authenticator in Logon Manager.

- [Modifying the Access Portal Service Configuration](#)
- [Modifying the Logon Manager Configuration](#)

For more information on configuring Logon Manager repository settings, see the guide *Deploying Logon Manager with a Directory-Based Repository*.

**Note:**

For an Application Policy to be compatible, enable the "User Visible" setting in the Application profile in the Oracle Access Management Console. You must perform this task in addition to the modifications that are described in the following topics:

See [Modifying the Access Portal Service Configuration](#).

---

**54.3.16.1 Modifying the Access Portal Service Configuration**

You can modify the Access Portal service configuration.

To modify:

1. In the IDS profile you have configured for the Access Portal Service, ensure that you are connecting with a user who possesses root privileges (e.g., `orcladmin`).
2. If you are using Oracle Internet Directory as your repository, set the following permissions to permit Logon Manager to its First Time Use wizard:
  - a. For the `vGoLocator` object and its default child object:

```
orclaci = access to attr=(*) by * BindMode="Simple"
(read,search,compare)

orclaci = access to entry by * BindMode="Simple" (browse)
```
  - b. For the `People` container:

```
orclaci = access to attr=(*) by * BindMode="Simple"
(read,write,search,compare)

orclaci: access to entry by * BindMode="Simple"
(browse,add,delete)
```
3. Ensure that the `PolicyCache TTL` is set to a positive, non-zero value.

**54.3.16.2 Modifying the Logon Manager Configuration**

You can modify the Logon Manager configuration by connecting to your repository.

To modify:

1. Launch the Enterprise Single Sign-On Suite Administrative Console and connect to the Access Portal Service repository.
2. If you are using Active Directory as your repository, do the following (otherwise, skip this step):
  - a. Navigate to **Global Agent Settings > Live > Synchronization > ADEXT**.
  - b. Select the check box next to the **Use secure location for storing user settings** option and select **Yes** from the drop-down menu.
3. Navigate to **Global Agent Settings > Live > Authentication > Authentication Manager** and configure the graded authenticators as required by your environment. For more information, refer to the *Enterprise Single Sign-On Suite Administrator's Guide*.

4. Navigate to Global Agent Settings > Live > Authentication and configure each authenticator as required by your environment, noting the following:
  - If using Oracle Internet Directory as your repository, there are two **Recovery Method** options **Passphrase suppression using entryUUID** and **Passphrase suppression using secure key**. Select **Passphrase suppression using secure key** if displayed; otherwise select **Passphrase suppression using entryUUID**.
  - If using Active Directory as your repository, set the **Recovery Method** option to **Passphrase suppression using user's SID**.

For more information, see the guide *Deploying Logon Manager with a Directory-Based Repository*.

5. Navigate to Global Agent Settings > Live > Synchronization and configure the appropriate synchronizer as required by your environment, noting the following:
  - Enable the **Use aggressive synchronization** option.
  - Enable the **Resynchronize when network or connection status changes** option.
  - Set the **Interval for automatic resynchronization** option to 1.
6. Publish your settings to the repository:
  - a. In the tree on the left-hand side right-click **Live** and select **Publish** from the context menu.
  - b. Click **Browse** and select the target path within the repository. (If prompted, enter the appropriate connection parameters and click **OK** to connect.)
  - c. In the **Available configuration objects** list, double-click **Live** to move it to the list of objects selected for publishing.
  - d. Click **Publish** and wait for the operation to complete.

## 54.4 Enabling Form-Fill Single Sign-On for an Application

You can enable form-fill single sign-on functionality for an application with the Access Portal Service.

The following topic describes how to enable form-fill single sign-on functionality:

- [Configuring a Form-Fill Application Policy](#)
- [Configuring the OTD ESO Direct Submit Server Application Function](#)
- [Configuring Proxy Rules for an Oracle Access Portal Application](#)
- [Configuring the Webgate Request Filtering](#)

### 54.4.1 Configuring a Form-Fill Application Policy

After you create the application policy, you must add a proxy-enabled application URL to the policy to enable form-fill functionality. Once configured, you must publish the policy to the repository and test it to ensure that form-fill single-sign on is functioning as expected.

The following topics describe how to configure a form-fill application policy:

- [Creating a Form-Fill Application Policy](#)
- [Adding a Proxy-Enabled URL to a Form Fill Application Policy](#)
- [Configuring Mock Credential Field Values](#)
- [Configuring Form Masking](#)
- [Publishing a Policy to the Repository](#)
- [\(Optional\) Importing the Policy in the Oracle Access Manager Console](#)
- [Testing the Configuration of the Policy](#)

#### 54.4.1.1 Creating a Form-Fill Application Policy

You can create a Form-Fill application policy using Oracle Enterprise Single Sign-On Administrative Console.

To create:

1. Launch the Oracle Enterprise Single Sign-On Administrative Console.
2. In the left-hand tree right-click the **Applications** node and select **New Web Application** from the context menu.
3. In the dialog that appears, enter a descriptive name and click **Next**. This will appear as the application policy name in Oracle Access Manager Console.
4. In the screen that appears, select the desired form type and click **OK**.
5. In the screen that appears, enter the URL of the target application.
6. Click **Detect Fields**.

The application's logon form appears in the window and the appropriate fields are automatically detected and configured. Verify that:

- a. The fields have been detected and configured correctly in the field list.
- b. A Submit Button is detected. If no Submit button is defined, Silent Credential Capture will not function.

For more information on creating application policies (also known as templates), see the guide *Creating and Configuring Logon Manager Application Templates*.

7. Click **OK** to save the application policy.
8. In the **General** tab, provide optional metadata describing the application (this metadata will appear in the Access Portal reference application or another user interface of your choice, if parsed):
  - **Description** – a meaningful description of the application for the user.
  - **Reference** – internal reference describing the version/variant of the application template.
  - **Category** – the category under which the application will appear in the Access Portal reference application; for example, "Finance," "Development," and so on.

- **Icon Image URL** – URL to the icon image that will appear next to the application entry in the Access Portal reference application.
  - **Logo Image URL** – URL to the full-size application logo image that will appear in the Access Portal reference application.
  - **Vendor** – the vendor of the application.
  - **Administrator** – contact information for the application's administrator within your organization.
9. Select the desired users and/or user groups to whom this template will be available:
- a. Select the **Security** tab.
  - b. Select the Access Portal Service repository from the **Directory** drop-down menu.
  - c. Click **Add**.
  - d. In the dialog that appears, enter the name of the target user or group.
  - e. Click **Check Names** to verify the user or group exists in the directory; if you receive an error, re-enter the name and try again.
  - f. Click **OK** to save your changes.

#### 54.4.1.2 Adding a Proxy-Enabled URL to a Form Fill Application Policy

You can add a proxy-enabled URL to a Form Fill application policy from the policy's **General** tab.

To add:

1. In the policy's **General** tab, double-click the target form.
2. In the dialog that appears, select the **Identification** tab and click **Add**.
3. In the dialog that appears, select the Regular Expression radio button and enter a launch URL in regular expression format for the target application.

You must trim any session IDs or other session-sensitive parameters from the URL, as they will become invalid as soon as the session expires. For example:

```
. *?https://otd_proxy_host\\.oracle\\.com:8282/target_webgate/login\
\\.jsp.*
```

4. Click **OK**; then click **OK** in the parent dialog to save your changes.

#### 54.4.1.3 Configuring Mock Credential Field Values

The Access Portal Service allows you to configure mock credential field values which will be displayed in the browser during injection for each configured field to prevent man-in-the-middle snooping.

To configure mock credential field values:

1. In the policy's **General** tab, double-click the target form.
2. In the dialog that appears, select the **Proxy** tab.

3. In the **Mock Fields** list, select the desired field and click **Edit**.
4. In the dialog box that appears, enter the desired mock value and click **OK**.

To clear the mock values for all fields, click **Clear All**.

#### 54.4.1.4 Configuring Form Masking

If you want to prevent the user from seeing or altering the injected credentials, you can configure the Access Portal Service to mask the entire form from view using an overlay (a solid color or an image of your choice).

Keep in mind that:

- If no application credentials exist for the target form, the form will not be masked even if the mask has been configured, and the user will be able to enter their own credentials to continue with the form.
- If more than one set of credentials exists for the target form, the Logon Chooser dialog will appear, allowing the user to choose the desired credentials to inject.

To configure form masking:

1. In the policy's **General** tab, double-click the target form.
2. In the dialog that appears, select the **Proxy** tab.
3. Select the **Mask Form** check box to enable form masking.
4. Configure the form mask as follows:
  - **Mask form** – enable/disable masking for the form.
  - **RED/GRN/BLUE** – set the numerical value for the red, green, and blue components of the desired mask color.
  - **HEX** – enter the hexadecimal value for the desired mask color.
  - **Select color** – opens the color picker, allowing you to pick the desired mask color visually.
  - **Image** – relative path and filename of the desired mask image to be used instead of a solid color mask.
  - **Timeout** – number of seconds before the form mask is dismissed.
  - **Close button** – enable/disable the **Close** button on the form mask (allows user to remove the mask).
  - **Opacity** – percentage opacity of the form mask.
  - **Default** – reset all form mask options to default values.

#### 54.4.1.5 Publishing a Policy to the Repository

You can publish a policy to the repository.

To publish a policy to the repository:

1. In the left-hand tree, right-click the target application policy and select **Publish** from the context menu.

2. If prompted to connect to the repository, fill in the fields in the "Connect to Repository" dialog as required.
3. In the "Browse" dialog, navigate to the policies and credentials container you created in [Preparing and Enabling the Access Portal Service on an Oracle Repository](#).

For example: `ou=CO,dc=us,dc=oracle,dc=com`

4. Click **Publish**.

#### 54.4.1.6 (Optional) Importing the Policy in the Oracle Access Manager Console

Instead of publishing the policy to the repository, you can import it in the Oracle Access Manager Console to further edit its basic settings there.

If you have already published it to the repository, you can skip this step, as the Oracle Access Manager console will retrieve it from the repository and display it in its policies list. If you modify the policy in the Oracle Access Manager console and then decide to edit it in the Enterprise Single Sign-On Administrative Console, you will need to manually pull down the updated version from the Access Portal Service repository.

---



---

#### Note:

Oracle recommends creating and configuring the policy in the Enterprise Single Sign-On Administrative Console as not all Oracle Access Portal features can be configured in the Oracle Access Manager Console. Additionally, you must select the Unicode encoding when saving the exported .INI file; the Oracle Access Management console does not support importing non-Unicode files.

---



---

To optionally import a policy in the Oracle Access Manager:

1. Start the Enterprise Single Sign-On Administrative Console and import the desired policy (template) from the repository.
2. Export the policy to a file:
  - a. From the **File** menu, select **Export**.
  - b. In the "Export to .INI File" dialog that appears, select the policy from the list and click **OK**.
  - c. In the dialog that appears, select **Unicode** from the **Encoding** drop-down list, provide the desired path and name for the exported file, and click **Save**.
3. Import the template file into Oracle Access Manager:
  - a. Log on to the Oracle Access Manager console.
  - b. In the "Access Manager" section of the page that appears, click **Applications**.
  - c. In the toolbar above the application list, click **Import** (blue down-arrow).
  - d. In the "Import Applications" pop-up that appears, click **Browse**.
  - e. In the dialog that appears, navigate to the policy file, and click **Open**.

- f. Click **OK** in the "Import Applications" pop-up.
- g. In the list of applications to import displayed by the pop-up, select the desired application and click **Import**.
- h. In the application configuration page that appears, verify that the configuration settings in each tab have been properly carried over and make any changes if necessary. When you have finished, click **Save**.

The imported application policy appears in the application list.

#### 54.4.1.7 Testing the Configuration of the Policy

You can test the configuration of the policy.

To test:

1. In a Web browser, navigate to `http://otd.hostname:8282/target_webgate` and log on with your repository credentials.

The logon form's fields will highlight indicating the Access Portal Service is ready to capture application credentials.

2. Enter your application credentials into the logon form and submit them.
3. Close the browser and access the application URL again.

You are automatically logged on to the application.

If either the credential capture or automatic logon (after credentials have been captured) do not occur, check your configuration for errors.

### 54.4.2 Configuring the OTD EsoDirectSubmit Server Application Function

Configure the EsoDirectSubmit Server Application Function (SAF) to match with the URL path of the targeted application's login page.

1. Determine the URL path of the targeted login form.

For example, `/ComplexApp/login.jsp`

2. Edit the file `/OTD11g/trafficdirector_Home_1/instances/targetInstance/config/targetOTDconfiguration.conf`.
3. In the `targetOTDconfiguration.conf` file, insert the following command before the line `Service fn="proxy-retrieve" method="*"`:

```
<if $uri=~"/ComplexApp/login.jsp">
Service fn="EsoDirectSubmit" method="GET"
</if>
```

---

**Note:** Optionally, you can add multiple application URLs to a single `if` block using the OTD Expression Syntax. See *Using Variables, Expressions, Wildcards, and String Interpolation in Oracle Traffic Director Configuration File Reference*.

---

4. Run **reconfig** located in the bin directory of your OTD instance to apply these changes.



### 54.4.3 Configuring Proxy Rules for an Oracle Access Portal Application

You must adhere to some basic guidelines for creating any proxy rules that are necessary to intercept the user connections to the target application and redirect them to pass through the Webgate plugin.

For in-depth information on configuring Oracle Traffic Director, please see the *Oracle Traffic Director Administrator's Guide*.

Since the user connection requested is intercepted by Oracle Traffic Director and redirected to the origin server, all resources referenced within the page's code must have their path rewritten to point to the Oracle Traffic Director origin server instead of the original host; otherwise, those elements will not be loaded and the page will display improperly and likely not function as intended. The following topics provide guidelines for the types of resources that must be rewritten for the page to function properly after proxy redirection:

- [Path Rewriting Guidelines for HTTP Request/Response Headers](#)
- [Path Rewriting Guidelines for Browser Cookies](#)
- [Path Rewriting Guidelines for Page Content](#)

#### 54.4.3.1 Adding an Oracle Access Portal Application to Oracle Traffic Director

You need to configure Oracle Traffic Director proxy rules for an Oracle Access Portal Application that resides on a single host server.

Any applications that are hosted on multiple servers are not covered. Working knowledge of Oracle Traffic Director concepts and configuration procedures is assumed. To add an Oracle Access Portal application to Oracle Traffic Director:

1. Select the protocol(s) required by the origin server application pages (home, logon, post URL, landing page) from the following scenarios:
  - **HTTP only.** All of the application's pages are served over HTTP.
  - **HTTPS only.** All of the application's pages are served over HTTPS.
  - **HTTP pre-logon/HTTPS post-logon.** Home and login pages are served over either HTTP or HTTPS; however, the landing page for successfully authenticated users is served over HTTPS.
  - **HTTP with POST over HTTPS.** All of the pages are served over HTTP but the logon form POST transaction occurs over HTTPS.

For proper security, Oracle highly recommends matching the proxy listener protocols with those of their respective origin server pages when configuring the proxy rules. For example, do not configure an HTTP proxy listener for a page that is originally served over HTTPS.

On the other hand, if you want to configure an HTTPS listener for a page that is originally server over HTTP, you will need to configure additional proxy rules - for more information, see the Oracle Traffic Director documentation.

2. Create the appropriate listeners for each protocol and assign them to the target virtual server.

3. Create the corresponding origin server pools for each protocol. Include the protocol and URI of the origin application to clearly distinguish between each pool. For example:
  - **URI:** `http://www.originapp.com`  
**Pool name:** `origin-server-pool-http-www-originapp.com`
  - **URI:** `https://www.originapp.com`  
**Pool name:** `origin-server-pool-https-www-originapp.com`
4. Create a route for the origin application using the New Route Wizard as follows:
  - a. Select the origin server pool you created in step 3. If you created more than one origin server pool, select the HTTP (non-SSL) pool.
  - b. Create a URI route condition for the application - this will be the path at which your application will be accessible. Oracle recommends setting this value to the name of your origin application or using the condition builder. This path will be called the `PROXY_MAP` later in this procedure.  
For example: `$uri =~ "^/originapp"`
  - c. Complete the remaining steps in the wizard to finish creating the route.
5. In the list of routes, select the route you created in step 4 and open the **Advanced Settings** section.
6. In the **Rewrite Headers** field, add the host header for the origin application in the following format:  
*location,content-location,host*
7. Apply the following route template and replace the variables as described below:
  - `#PROXY_MAP#` - path to the proxied application (reverse map of the **From-URI** value) from step 4b. For example: `originapp`.
  - `#OTD_HTTP#` - port of the application's HTTP listener.  
For example: `80`
  - `#OTD_HTTPS#` - port number of the application's HTTPS listener.  
For example: `443`
  - `#ORIGIN_HOST#` - host name of the origin server pool to rewrite.  
For example: `www.originapp.com`
  - `#DOCUMENT-DOMAIN#` - domain attribute in which cookie values can be specified.  
For example: `originapp.com`  
`#Instructs OTD to map the incoming URI from the user's browser to the root path of the origin server. OTD also uses these values to create a reverse mapping to rewrite cookie paths. It is not usually necessary to change the value of the to parameter.`

```

NameTrans fn="map" to="/" from="/#PROXY_MAP#" #Rewrite
the https referer header <If defined $referer and
$referer =~ "https://.*?\.\.us\.\.oracle\.\.com:#OTD_HTTPS#/#
PROXY_MAP#/(.*)$" > AuthTrans fn="set-variable" set-
headers="referer=https://#ORIGIN_HOST#/$1" </If> #Rewrite
the http referer header <If defined $referer and $referer
=~ "http://.*?\.\.us\.\.oracle\.\.com:#OTD_HTTP#/#
PROXY_MAP#/(.*)$" > AuthTrans fn="set-variable" set-
headers="referer=http://#ORIGIN_HOST#/$1" </If> #Remove
potential headers that may interfere with mixed proxy
content <If defined $srvhdrs{'content-security-policy'}>
Output fn="sed-response-header" name="content-security-
policy" sed="s|script-src |script-src 'self' |g" </If> <If
defined $srvhdrs{'access-control-allow-origin'}> Output
fn="set-variable" remove-srvhdrs="access-control-allow-
origin" </If> #rewrite the location header when origin
server is redirecting from HTTP to HTTPS <If defined
$srvhdrs{'location'} and $srvhdrs{'location'} =~
"^https://#ORIGIN_HOST#(:\d+)?(/?.*)" > Output fn="set-
variable" $srvhdrs{'location'}="https://
$urlhost:#OTD_HTTPS#/#PROXY_MAP#$2" </If> <If defined
$srvhdrs{'location'} and $srvhdrs{'location'} =~
"^http://#ORIGIN_HOST#(:\d+)?(/?.*)" > Output fn="set-
variable" $srvhdrs{'location'}="http://
$urlhost:#OTD_HTTP#/#PROXY_MAP#/$2" </If> #Insert the
Dynamic Proxy Script parameters AuthTrans fn="set-
variable" insert-vars="DYNAMIC-PROXY-ENABLE=on" insert-
vars="DYNAMIC-PROXY-MAP-TO=#PROXY_MAP#" insert-
vars="DYNAMIC-PROXY-MAP-FROM=/" insert-vars="DYNAMIC-
PROXY-HTTPS=#OTD_HTTPS#" insert-vars="DYNAMIC-PROXY-
HTTP=#OTD_HTTP#" insert-vars="DYNAMIC-PROXY-IGNORE-
PATHS=" #Map all src,href,action,background,data-li-
search-action and data-li-advanced-link attributes found
in html content to the proxied path Output fn="insert-
filter" filter="sed-response" sed="s|\\(src=\\)\\|/\\
([^/][^\\]*\\|\\|\\1\\|/#PROXY_MAP#\\|\\2 oap=\\\"true\\\"|g"
sed="s|\\(src=\\)'|/\\([^[^/][^']*\\|\\|\\1\\|/#PROXY_MAP#\\|\\2
oap='true'|g" sed="s|\\(href=\\)\\|/\\([^[^/][^\\]*\\|\\|\\
\\1\\|/#PROXY_MAP#\\|\\2 oap=\\\"true\\\"|g" sed="s|\\(href=\\
\\)'|/\\([^[^/][^']*\\|\\|\\1\\|/#PROXY_MAP#\\|\\2 oap='true'|g"
sed="s|\\(action=\\)\\|/\\([^[^/][^\\]*\\|\\|\\1\\|/
#PROXY_MAP#\\|\\2 oap=\\\"true\\\"|g" sed="s|\\(action=\\)'|/\\
([^[^/][^']*\\|\\|\\1\\|/#PROXY_MAP#\\|\\2 oap='true'|g" sed="s|
\\(background=\\)\\|/\\([^[^/][^\\]*\\|\\|\\1\\|/
#PROXY_MAP#\\|\\2 oap=\\\"true\\\"|g" sed="s|\\(background=\\
\\)'|/\\([^[^/][^']*\\|\\|\\1\\|/#PROXY_MAP#\\|\\2 oap='true'|g"
sed="s|\\(data-li-advanced-link=\\)\\|/\\([^[^/][^\\]*\\|\\
\\|\\|\\1\\|/#PROXY_MAP#\\|\\2 oap=\\\"true\\\"|g" sed="s|\\(data-
li-advanced-link=\\)'|/\\([^[^/][^']*\\|\\|\\1\\|/#PROXY_MAP#\\
\\2 oap='true'|g" sed="s|\\(data-li-search-action=\\)\\|/\\
\\([^[^/][^\\]*\\|\\|\\1\\|/#PROXY_MAP#\\|\\2 oap=\\\"true\\\"|g"
sed="s|\\(data-li-search-action=\\)'|/\\([^[^/][^']*\\|\\|\\
\\1\\|/#PROXY_MAP#\\|\\2 oap='true'|g" append-newline-at-
end="false" type="(text/html*|text/xml*)" #Map CSS
attributes to the proxied path Output fn="insert-filter"

```

```

filter="sed-response" sed="s|url(\\"/\\([^\"]*)|
url(\\"/#PROXY_MAP#/\\"|g" sed="s|url('\/\\([^\"]*)|
url('#PROXY_MAP#/\\"|g" sed="s|url(/\\([^\"]*)|url(/
#PROXY_MAP#/\\"|g" type="(text/css*|text/html*)" append-
newline-at-end="false" #Rewrite full URL links to the OTD
proxied host/port. These sed expressions keep the
existing protocols in the URL. Output fn="insert-filter"
filter="sed-response" sed="s|http://#ORIGIN_HOST#:80|
http://$urlhost:#OTD_HTTP#/#PROXY_MAP#|g" sed="s|http://
#ORIGIN_HOST#|http://$urlhost:#OTD_HTTP#/#PROXY_MAP#|g"
sed="s|https://#ORIGIN_HOST#:443|https://
$urlhost:#OTD_HTTPS#/#PROXY_MAP#|g" sed="s|https://
#ORIGIN_HOST#|https://$urlhost:#OTD_HTTPS#/#PROXY_MAP#|g"
sed="s|https:\\\\\/\\\\\/#ORIGIN_HOST#|https:\\\\\/\\\\\/
$urlhost:#OTD_HTTPS#\\\\\/#PROXY_MAP#|g" sed="s|http:\\\\
\\\\\/#ORIGIN_HOST#|http:\\\\\/\\\\\/$urlhost:#OTD_HTTP#\\\\
\\\\\/#PROXY_MAP#|g" type="(text*|application*)" sed="s|//
#ORIGIN_HOST#|https://$urlhost:#OTD_HTTPS#/#PROXY_MAP#|g"
append-newline-at-end="false" #Sanitize any illegal
javascript domain values for our proxied host Output
fn="insert-filter" filter="sed-response" sed="s|\\
(document.domain=\\\"\\\")#DOCUMENT_DOMAIN#\\\"|\\1$urlhost\\\"|
g" sed="s|\\(document.domain=\\\")#DOCUMENT_DOMAIN#'|\\
\\1$urlhost'|g" sed="s|\\(document.domain = \\\"\\
\\\")#DOCUMENT_DOMAIN#\\\"|\\1$urlhost\\\"|g" sed="s|\\
(document.domain = '\\\")#DOCUMENT_DOMAIN#'|\\1$urlhost'|g"
type="(text*|application*)" append-newline-at-end="false"
#Attempt to rewrite any javascript page redirects Output
fn="insert-filter" filter="sed-response" sed="s|\\
(location.replace(\\\"\\\"/\\([^\"]*)*\"\\\")|\\1\"/
#PROXY_MAP#/\\"|g" sed="s|\\(location.replace(\\\"'\\"/\\
([^\"]*)*'\\"|\\1'#PROXY_MAP#/\\"|g" sed="s|\\
(location.href =\\\"\\\"/\\([^\"]*)*\"\\\")|\\1/#PROXY_MAP#\\
\\2|g" sed="s|\\(location.href ='\\"/\\([^\"]*)*'\\"|\\1/
#PROXY_MAP#\\2|g" type="(text*|application*)" append-
newline-at-end="false" #Attempt to rewrite any JSON
objects that appear as URI paths.Output fn="insert-filter"
filter="sed-response" sed="s|\\(:\\\"\\\"/\\([^\"]*)*\"\\
\\)|\\1/#PROXY_MAP#\\2|g" sed="s|\\(:'\\"/\\([^\"]*)*'\
\\)|\\1/#PROXY_MAP#\\2|g" type="application/json*" append-
newline-at-end="false" #rewrite any javascript page
redirects common in ADF applications Output fn="insert-
filter" filter="sed-response" sed="s|\\(redirect url=\\\"/\\"
\\)|\\1#PROXY_MAP#/\\"|g" sed="s|<redirect>/\\([^\"]*)*\"\\
|<redirect>/#PROXY_MAP#/\\"|g" type="text/xml*" #Remove any
domain attributes from the cookie header. This will force
the browser to use the otd host name as a default Output
fn="sed-response-header" name="set-cookie" sed="s|
domain=#DOCUMENT_DOMAIN#||g" sed="s|
Domain=#DOCUMENT_DOMAIN#||g" sed="s|
domain=.#DOCUMENT_DOMAIN#||g" sed="s|
Domain=.#DOCUMENT_DOMAIN#||g" sed="s|
domain=.#ORIGIN_HOST#||g" sed="s|Domain=.#ORIGIN_HOST#||
g"

```

8. Paste the generated template into the target route (e.g. `originapp`) section in the `$SERVER-obj.conf` file.
9. If you created one or more HTTPS listeners in step 2, make the following changes in the target route (e.g., `originapp`) section of the `$SERVER-obj.conf` file:

- a. Locate the following statement:

```
Route fn="set-origin-server" origin-server-pool= "origin-
server-pool-http-www-originapp-com" rewrite-host="true"
```

- b. Add the following security rule directly above the statement listed in step 9a:

```
<If $security>
```

```
Route fn="set-origin-server" origin-server-pool="origin-
server-pool-https-www-originapp-com" rewrite-host="true"
```

```
</If>
```

10. Reconfigure the server.

#### 54.4.3.2 Path Rewriting Guidelines for HTTP Request/Response Headers

HTTP request and response headers contain parameters that must be rewritten to point to the Oracle Traffic Director origin server. Oracle Traffic Director can rewrite basic location headers that contain the origin server host name and exact protocol, or a relative path.

A typical HTTP request header appears as follows:

```
GET /web/en-US/default.aspx HTTP/1.1
```

```
Host: www.oracle.com
```

```
User-Agent: Mozilla/5.0 (Windows NT 6.1; WOW64; rv:23.0) Gecko/
20100101 Firefox/23.0
```

```
Accept: text/html, application/xhtml+xml,application/
xml;q=0.9,*/*;q=0.8
```

```
Accept-Language: en-US,en;q=0.5
```

```
Accept-Encoding: gzip, deflate
```

```
Referer: http://www.oracle.com/web/en-US/default.aspx ?root=1
```

```
Connection: keep-alive
```

This example header contains the following parameters that require path rewriting:

- `GET` - contains the path of the requested page relative to the Web root, plus HTTP protocol version.

For example: `GET /web/en-US/default.aspx HTTP/1.1`

An example proxy rule for rewriting the `GET` parameter:

```
NameTrans fn="map" to="/" from="/myLocalPath"
```

- `Host` - contains the URL of the page host.

For example: `www.oracle.com`

An example proxy rule for rewriting the `Host` parameter:

```
Route fn="set-origin-server" origin-server-
pool="myoriginserverpool" rewrite-host="true"
```

- **Referer** - contains the URL of the page that referred the request. For example:  
`http://www.oracle.com/web/en-US/default.aspx?root=1`

An example rule for rewriting the **Referer** parameter:

```
<If defined $referer and $referer =~ "https://
myoriginserver.oracle.com/myLocalPath/(.*)$" >

AuthTrans fn="set-variable" set-headers="referer=https://
www.oracle.com/$1"

</If>
```

---

**Note:**

Since Web applications vary widely, in addition to the above examples, you must examine your HTTP headers to account for any other parameters referencing a URL or a relative path.

---

A rewritten version of our example header would then look as follows:

```
GET /myLocalPath/web/en-US/default.aspx HTTP/1.1
Host: myoriginserver.oracle.com:8484

User-Agent: Mozilla/5.0 (Windows NT 6.1; WOW64; rv:23.0) Gecko/
20100101 Firefox/23.0

Accept: text/html, application/xhtml+xml,application/
xml;q=0.9,*/*;q=0.8

Accept-Language: en-US,en;q=0.5

Accept-Encoding: gzip, deflate

Referer: https://myoriginserver.oracle.com:8484/myLocalPath/
web/en-US/default.aspx?root=1

Connection: keep-alive
```

Oracle Traffic Director can **not** handle location redirects to another origin server. For example, if a logon page hosted on one host redirects the user to a page on another host upon successful logon, you must configure the rewriting rules for this remapping manually. For example:

```
<Object name="route-oracle-travel-sso">

<If defined $srvhdrs{'location'} and $srvhdrs{'location'} =~
"(http|https)://portal.myapplication.com(.*)$" >

Output fn="set-variable" $srvhdrs{'location'}="https://
myoriginserver.oracle.com:8484/travel-portal$2"

</If>

Output fn="sed-response-header" name="set-cookie" sed="s|path=/
travel-sso/|path=|g"

</Object>

<Object name="route-travel-portal">
```

```
Route fn="set-origin-server" origin-server-pool="origin-server-portal-oracle-travle" rewrite-host="true"
</Object>
```

#### 54.4.3.3 Path Rewriting Guidelines for Browser Cookies

The path and domain parameters in cookies need to be rewritten to point to the Oracle Traffic Director origin server instead of the target application host.

For example:

```
Set-cookie: v1st=1666B5EACC906D6; path=/; expires=Wed, 19 Feb 2020 14:28:00 GMT; domain=.www.oracle.com
```

Must become:

```
Set-cookie: v1st=1666B5EACC906D6; path=/myLocalPath/; expires=Wed, 19 Feb 2020 14:28:00 GMT; domain=.myoriginserver.oracle.com
```

When configuring cookie rewriting rules, note the following:

- Oracle Traffic Director cannot rewrite wildcarded domains, such as `.oracle.com`. A target host name must be specified, for example: `.www.oracle.com`.
- If your application shares cookies across multiple domains, you must create separate cookie rewriting rules for each domain.
- You must strip out the Oracle Authentication Manager cookie from the cookie set request, as it interferes with certain Web applications, such as Dropbox.

Example rule for stripping out the Oracle Authentication Manager cookie:

```
AuthTrans fn="sed-request-header" name="cookie" sed="s|OAMAuthnCookie[^;]*;| |g" sed="s|OAMRequestContext[^;]*;| |g"
```

- You must strip out Oracle Authentication Manager headers before sending them to the application host.

#### 54.4.3.4 Path Rewriting Guidelines for Page Content

Oracle Traffic Director does not directly provide the means to rewrite host names and resource paths within the HTML code of the target page.

You must use sed expressions to rewrite those values. Common HTML elements whose values will require rewriting include `src`, `href`, and `action`.

Example sed rule set for rewriting the `src`, `href`, and `action` elements:

```
Output fn="insert-filter" filter="sed-response" sed="s|\\(src\\|\\)=\\\"/\\(\\([\\^\"|\\^/])\\|\\|1=\\\"/myLocalPath/\\|2|g" sed="s|\\(src\\|\\)=\\\"/\\(\\([\\^\"|\\^/])\\|\\|1=\\\"/myLocalPath/\\|2|g" sed="s|\\(href\\|\\)=\\\"/\\(\\([\\^\"|\\^/])\\|\\|1=\\\"/myLocalPath/\\|2|g" sed="s|\\(href\\|\\)=\\\"/\\(\\([\\^\"|\\^/])\\|\\|1=\\\"/myLocalPath/\\|2|g" sed="s|\\(action\\|\\)=\\\"/\\(\\([\\^\"|\\^/])\\|\\|1=\\\"/myLocalPath/\\|2|g" sed="s|\\(action\\|\\)=\\\"/\\(\\([\\^\"|\\^/])\\|\\|1=\\\"/myLocalPath/\\|2|g" type="text/html"
```

Example rule for rewriting hardcoded host names:

```
Output fn="insert-filter" filter="sed-response" sed="s|https://
www.oracle.com|https://myoriginserver.oracle.com:8484/
myLocalPath|g" type="(text*|application*)"
```

Example rule for rewriting path references within CSS elements:

```
Output fn="insert-filter" filter="sed-response" sed="s|url(\"/>\
([^\"]|"/])\)|url("/myLocalPath/\1|g" sed="s|url('"/>\
([^\"]|"/])\)|url('/myLocalPath/\1|g" sed="s|url(/\/\
([^\"]|"/])\)|url(/
myLocalPath/\1|g" type="text/css*"
```

Note the following when creating host name and path rewriting rules:

- You must include the "Content-Type" attribute values for content types used by the target page in your Oracle Traffic Director configuration file to provide maximum content compatibility when rewriting.
- Compressed content is not directly supported by sed; you must configure Oracle Traffic Director to decompress compressed HTML content before applying sed rewriting rules to the content, and recompress it afterwards.

Example rules for decompressing and recompressing HTML content:

```
Output fn="insert-filter" type="(text*|application*)"
filter="http-decompression"
```

```
Output fn="insert-filter" type="(text*|application*)"
filter="http-compression"
```

- In some cases, you may be able to strip out the "Accept Encoding" parameter in the request header to prevent the application host from sending compressed data in the first place.

Example rule for stripping out the "Accept Encoding" header:

```
AuthTrans fn="set-variable" remove-headers="accept-encoding"
```

- JavaScript code varies widely in complexity and must be examined on a case-by-case basis in order to create clean, compatible rewriting rules.

#### 54.4.4 Configuring the Webgate Request Filtering

You can configure Webgate Request Filtering using HTTP request filtering mechanisms.

The Webgate plugin provides the following HTTP request filtering mechanisms:

- JavaScript tag injection into incoming (to the user browser) HTML pages
- Mock credential substitution in outgoing POST requests
- HTTP Basic Authentication credential injection and credential capture
- Sanitization of outgoing HTTP requests to remove OAM/ESSO cookies and headers before the request is forwarded to the origin server

The Webgate plugin requires the following `Init` directives in `magnus.conf`:

- To load NSAPI filters and SAFs:

```
Init fn="load-modules"
funcs="OBWebGate_Init,OBWebGate_Authent,OBWebGate_Control,OB
WebGate_Err,OBWebGate_Handle401,OBWebGate_Response,EssoBasic
```



```
AuthInit,EssoBasicAuth,EssoClean" shlib="webgate.so"
obinstalldir="Webgate_Home_Dir"
obinstancedir="Webgate_Instance_Dir"

Init fn="OBWebGate_Init" obinstalldir="Webgate_Home_Dir"
obinstancedir="Webgate_Instance_Dir" Mode="PEER"
```

- To enable HTTP Basic Authentication:

```
Init fn="EssoBasicAuthInit" obinstalldir="Webgate_Home_Dir"
obinstancedir="Webgate_Instance_Dir" Mode="PEER"
```

where:

Parameter	Description
shlib	= "webgate.so" Full path to the webgate.so module.
obinstalldir	= "WebGate_Home_Dir" full path to the target Webgate installation directory.
obinstancedir	= "WebGate_Instance_Dir" full path to the Webgate instance directory.
ESSEnable	= "On Off" , default "On" Enable or disable all plugins.

#### 54.4.4.1 JavaScript Injection Filter

The JavaScript injection filter provides tag injection into pages incoming into the target user's Web browser.

The following table describes the supported parameters.

Parameter	Description
ESSEnable	= "on off", default "on" Add to either magnus.conf or obj.conf Enable or disable the JavaScript injection filter. Specifying this directive in magnus.conf disables all ESSO plugin features.
ESSOsearchTag	= "str", default "</head>" Add to obj.conf HTML tag to match on for JavaScript injection.
ESSOInjectTag	= "before after", default "before" Add to obj.conf Determines whether to inject the JavaScript tag before or after the ESSOsearchTag parameter.
ESSOsearchCaseSensitive	= "yes no", default "no" Add to obj.conf Determines whether the match is case sensitive.

Parameter	Description
ESSOScriptPath	= "path", default "/oamssso/columbiaWeb.js" Add to obj.conf Passed through to JavaScript as "src"
ESSOConsoleLoggingLevel	= "n", default "0", "5" is trace. Add to obj.conf Passed through to JavaScript as "essoConsoleLoggingLevel"
ESSOPartnerId	= "str" Add to magnus.conf Partner ID value. Passed through to JavaScript as "oam_partner". If present, takes precedence over the "id" value in ../webgate/config/ObAccessClient.xml

For example, adding the following to obj.conf

```
AuthTrans fn="set-variable" insert-vars="DYNAMIC-PROXY-ENABLE=on" insert-vars="DYNAMIC-PROXY-MAP-TO=/myTarget" insert-vars="DYNAMIC-PROXY-MAP-FROM=/" insert-vars="DYNAMIC-PROXY-HTTPS=18484" insert-vars="DYNAMIC-PROXY-HTTP=18282" insert-vars="DYNAMIC-PROXY-IGNORE-PATHS=/ignoreMe"
```

will produce the following result:

```
Output fn="insert-filter" type="text/*" filter="esso_webproxy" ESSOSearchTag="</title>"
```

#### 54.4.4.2 Dynamic Proxy Support

Dynamic Proxy can be enabled and JS Injection Filter Parameters can be inserted into your route as Oracle Traffic Director server variables. To configure the dynamic proxy behavior, the non-null values of the parameters passed to the JavaScript tag.

When dynamic proxy support is enabled (via the `DYNAMIC-PROXY-ENABLE` parameter), the following parameters are inserted into your route as Oracle Traffic Director server variables and passed down as JavaScript attributes to configure the dynamic proxy behavior.

Only non-null values will be passed to the JavaScript tag. If either `DYNAMIC-PROXY-MAP-FROM` or `DYNAMIC-PROXY-MAP-TO` value is not specified, an error ("Dynamic proxy enabled but missing mapTo/mapFrom") will be logged. Add these parameters to obj.conf.

Parameter	Description
DYNAMIC-PROXY-ENABLE	= "on off", default "off" Enables or disables the dynamic proxy functionality. When disabled, the parameters listed in the remainder of this table are not passed to the JavaScript injection filter.
DYNAMIC-PROXY-MAP-TO	Destination URI. Default is null (empty string).
DYNAMIC-PROXY-MAP-FROM	Source URI. Default is null (empty string).

Parameter	Description
DYNAMIC-PROXY-HTTPS	HTTPS port number. Default is null (empty string).
DYNAMIC-PROXY-HTTP	HTTP port number. Default is null (empty string).
DYNAMIC-PROXY-IGNORE-PATHS	URIs that should be ignored. Default is null (empty string).

For example:

```
<script type='text/javascript' id='MyProxy' src='/myjavascript/myJavaScript.js'essoConsoleLoggingLevel='5' ... mapTo='/myTarget' mapFrom='/' ignorePaths='/ignoreMe' otdHttps='18484' otdHttp='18282'></script></head>
```

#### 54.4.4.3 Configuring the Mock Credentials Filter

The Mock Credentials filter provides substitution of ESSO mock credentials in the outgoing POST request.

By default, OAM headers are stripped before the request is passed on to the origin server, but they can be forwarded with the `pass-oam-headers` parameter.

To enable, add a directive with the parameter to your directive in `obj.conf` as follows:

```
pass-oam-headers="true|false", default "false"
```

This includes the following headers (by default, they are omitted):

- OAM\_IMPERSONATOR\_USER
- OAM\_REMOTE\_USER
- OAM\_LAST\_REAUTHENTICATION\_TIME
- OAM\_IDENTITY\_DOMAIN

For example:

```
Input fn="insert-filter" type="application/x-www-form-urlencoded" filter="esso_webproxy_input" pass-oam-headers="true"
```

#### 54.4.4.4 Configuring HTTP Basic Authentication

You can configure the HTTP Basic Authentication that provides the ability to capture and inject credentials from and into Web browser basic authentication (modal) dialogs.

Configure HTTP Basic Authentication in the `magnus.conf` as follows:

- Add the `EssoBasicAuthInit` and `EssoBasicAuth` functions to the `load-modules Init` directive (explained in [Configuring the Webgate Request Filtering](#)).
- Add a standalone `Init` directive that loads the `ESSOBASICAuthInit` function:

For example:

```
Init fn="load-modules"
funcs="OBWebGate_Init,OBWebGate_Authent,OBWebGate_Control,OBWebGate_Err,OBWebGate_Handle401,OBWebGate_Response,EssoBasicAuthInit
```

```
,EsoBasicAuth,EsoClean" shlib="webgate.so"
obinstalldir="Webgate_Home_Dir" obinstancedir="Webgate_Instance_Dir"

Init fn="EsoBasicAuthInit" obinstalldir="Webgate_Home_Dir"
obinstancedir="Webgate_Instance_Dir" Mode="PEER"
```

**Note:**

HTTP Basic Authentication is enabled by default when you install the Access Portal Service. To disable it, remove the `EsoBasicAuthInit` and `EsoBasicAuth` functions from the `load-modules Init` directive and delete the `fn="EsoBasicAuthinit"` standalone directive from the `magnus.conf` file.

Then, add one or more of the following parameters to `obj.conf` for the header injection SAF and the credential capture filter:

Parameter	Description
<code>policy</code>	<code>= "policy name"</code> Required. Name of the ESSO policy (application template) to use for authentication.
<code>realm</code>	<code>= "realm name"</code> Optional. The desired authentication realm of the target website, if more than one realm is in use.

For example:

```
NameTrans fn="EsoBasicAuth" policy="BasicAuth1" realm="realm1"
Output fn="insert-filter" filter="esso_output_capture"
policy="BasicAuth1" realm="realm1"
```

**54.4.4.5 HTTP Request Sanitizer**

The HTTP request sanitizer strips the proxied HTTP request of any cookies and headers added by Oracle Access Manager and the Webgate plugin before the request is forwarded to the origin server.

The sanitizer removes cookies with the following names:

- `OAM_Partner`
- `OAMAuthnCookie_*`
- `OAMRequestContext*`
- `OAMAuthnHintCookie`
- `OAM_*`
- `ESSO_BAH*` (Basic Authentication Hint, caches policy, realm, and credential GUID)

Request-specific cookie names (for example, containing the server name) are matched using a wildcard, indicated above by the trailing asterisk.

The sanitizer removes the following headers:

- OAM\_IMPERSONATOR\_USER
- OAM\_REMOTE\_USER
- OAM\_LAST\_REAUTHENTICATION\_TIME
- OAM\_IDENTITY\_DOMAIN

---



---

**Note:**

The Mock Credentials filter also provides this sanitization, but only while processing HTTP POST requests that contain mock credentials. The Webgate HTTP request sanitizer performs this function unconditionally on all requests.

---



---

To enable the sanitizer, add the `EssoClean` function to the `load-modules Init` directive in the `magnus.conf` file. For example:

```
Init fn="load-modules"
funcs="OBWebGate_Init,OBWebGate_Authent,OBWebGate_Control,OBWebGate_Err,OBWebGate_Handle401,OBWebGate_Response,EssoBasicAuthInit,EssoBasicAuth,EssoClean" shlib="webgate.so"
obinstalldir="Webgate_Home_Dir" obinstancedir="Webgate_Instance_Dir"
```

Then, add the following to the `obj.conf` file:

```
<If not $uri =~ "/oamssso">
NameTrans fn="EssoClean"
</If>
```

---



---

**Note:**

The HTTP Request Sanitizer is enabled by default when you install the Access Portal Service. To disable it, remove the `EssoClean` function from the `load-modules Init` directive in the `magnus.conf` file, and remove the above code from the `obj.conf` file.

---



---

The Webgate plugin passes the target credential's GUID value in the proxied URL to the origin server. If the target application does not function properly due to this value being passed, add the following rewrite rule to the Oracle Traffic Director configuration to strip out the GUID value:

```
<If defined $query and $query =~ "(.*?)(ESSOCredGuid={.*?})(.*)$"
AuthTrans fn="set-variable" set-reqpb="query=$1$3"
</If>
```

## 54.5 Adding a Federated Partner Provider Application

You can add a federated partner provider application to the Access Portal Service application catalog.

To add:

1. Log on to the Oracle Access Manager console.
2. In the **Quick Start Wizards** section of the **Launch Pad** tab, click **Application Registration**.
3. In the page that appears, fill in the fields as follows:
4.
  - a. **Vendor** - the vendor of the application.
  - b. **Name** - a descriptive name for the application.
  - c. **Type** - select **Federated Server Partner Provider Application** from this drop-down menu, as desired. The application will be available to all Access Portal users.
  - d. **Description** - a meaningful description of the application for the user.
  - e. **Reference** - internal reference describing the version/variant of the application template.
  - f. **Category** - the category under which the application will appear; for example, "Finance," "Development," and so on.
  - g. **Reference** - an internal reference for the application template, such as a version number or features that are enabled.
  - h. **Icon Image URL** - URL to the icon image that will appear next to the application entry. A preview of the image is displayed below the field to confirm the URL is valid.
  - i. **Logo Image URL** - URL to the full-size application logo image. A preview of the image is displayed below the field to confirm the URL is valid.
  - j. When you have finished, click **Next**.
5. In the "Configuration" page that appears, do the following:
  - a. In the **Partner** field, enter the desired federated partner name. If you don't know the exact name, click the **Search** (magnifier) icon, enter the desired search term in the pop-up that appears, select the desired partner from the list of results, and click **OK** to add that partner to the template.  
  
If you want to create a new partner, click **Create** and refer to the "Identity Federation" chapter for more information on creating a new federation partner.
  - b. In the **Application URL** field, enter the URL to the target application; obtain this URL from your application administrator.
  - c. Click **Next**.
6. In the summary page that appears, review your configuration choices. To make changes, click **Back**; otherwise, click **Finish**.

## 54.6 Adding an Oracle SSO Agent Application

You can add an Oracle SSO Agent application to the Access Portal Service application catalog.

To add:

1. Log on to the Oracle Access Manager console.
2. In the **Quick Start Wizards** section of the **Launch Pad** tab, click **Application Registration**.
3. In the page that appears, fill in the fields as follows:
4.
  - a. **Vendor** - the vendor of the application.
  - b. **Name** - a descriptive name for the application.
  - c. **Type** - select **SSO Agent Application** from this drop-down menu, as desired. The application will be available to all Access Portal users.
  - d. **Launch URL** - enter the URL of the target application; obtain this URL from your application administrator.
  - e. **Description** - a meaningful description of the application for the user.
  - f. **Reference** - internal reference describing the version/variant of the application template.
  - g. **Category** - the category under which the application will appear; for example, "Finance," "Development," and so on.
  - h. **Reference** - an internal reference for the application template, such as a version number or features that are enabled.
  - i. **Icon Image URL** - URL to the icon image that will appear next to the application entry. A preview of the image is displayed below the field to confirm the URL is valid.
  - j. **Logo Image URL** - URL to the full-size application logo image. A preview of the image is displayed below the field to confirm the URL is valid.
  - k. When you have finished, click **Next**.
5. In the summary page that appears, review your configuration choices. To make changes, click **Back**; otherwise, click **Finish**.

## 54.7 Creating an Application Configuration Package

The Access Portal Service ships with a configuration package tool that allows you to generate an environment-specific Access Portal Service configuration package for select target applications.

The package will contain pre-configured application templates, as well as Oracle Traffic Director content rewriting and proxy rules that configure the Access Portal Service for the target application.

### 54.7.1 Contents of the Application Configuration Package

The application configuration package contains information such as logo, URL, policy, and the Oracle Traffic Director configuration data.

The application configuration package contains the following:

- Logo image(s) or URL(s) to the logo image(s) for the application.

- Application policies (templates) and password generation policies (if defined) in `.INI` format, exported from the Enterprise Single Sign-On Administrative Console (`formfill.ini`).
- Oracle Traffic Director configuration data as described in the following topic:  
See [Enabling Form-Fill Single Sign-On for an Application](#).
  - Origin server pool definitions to be added to the `server.xml` file on the target managed server instance.
  - Rewriting rules for SED headers, page content, cookies, and so on, to be added to the `object.conf` file on the target Oracle Traffic Director instance.
  - Route configuration directives to be added to the `routes.conf` file on the target Oracle Traffic Director instance.

The Oracle Traffic Director configuration data must not contain any hardcoded values such as host names, port numbers, and session identifiers, and should use the preprocessor directives described in the next section.

## 54.7.2 Required Environment-Specific Configuration Data

You must provide the tool with the required environment-specific configuration data.

The following configuration data specific to your target environment needs to be provided:

- `%OTD_HOST%`
- `%OTD_HTTP_PORT%`
- `%OTD_HTTPS_PORT%`

Optionally, you may also provide forward proxy configuration as follows:

- `%FORWARD_PROXY_HOST%`
- `%FORWARD_PROXY_PORT%`

## 54.7.3 Customizing an Application Configuration Package to the Target Environment

You can create source configuration files before you start to generate an application configuration package. In addition, you can compress the files into a ZIP archive that is named after the target application for easier portability.

The following topics describe how to customize an application configuration package to the target environment:

- [Preprocessor Directives for the Oracle Traffic Director Configuration Data](#)
- [Rewriting Directives \(object.conf\)](#)
- [Origin Server Pools \(server.xml\)](#)
- [Routing Conditions \(routes.conf\)](#)



### 54.7.3.1 Preprocessor Directives for the Oracle Traffic Director Configuration Data

You must define preprocessor directives in your configuration files because a preprocessor parses the configuration data to apply the configuration to the target Oracle Traffic Director instance.

The preprocessor directives are as follows:

- %OTD\_HOST%
- %OTD\_HTTP\_PORT%
- %OTD\_HTTPS\_PORT%

Optionally, you can also define the following directives if your environment requires them:

- %FORWARD\_PROXY\_HOST%
- %FORWARD\_PROXY\_PORT%

For example, a regex match URI for an application would look as follows:

```
.*?https://%OTD_HOST%:%OTD_HTTPS_PORT%/myapplication.*
```

### 54.7.3.2 Rewriting Directives (object.conf)

The `object.conf` file includes the Oracle Traffic Director rewriting rules for SED, headers, content, and routes for the target application.

It must not contain any hardcoded values; use the preprocessor directives listed earlier instead.

For example:

```
<Object name="route-myapplication"><If defined $referer and
$referer =~ "$server_url/myapplication/(.*)$" >
AuthTrans fn="set-variable" set-headers="referer=https://
participant.myapplication.com/$1" </If>
NameTrans fn="map" to="/" from="/myapplication"
Route fn="set-origin-server" origin-server-pool="origin-server-
pool-participant-myapplication-com"
Output fn="insert-filter" filter="sed-response" sed="s|\\(src\\
\\)=\\"/\\([\\^"]\\)|\\1=\\"/myapplication/\\2|g" sed="s|\\(href\\)=
\\"/\\([\\^"]\\)|\\1=\\"/myapplication/\\2|g" sed="s|\\(action\\)=
\\"/\\([\\^"]\\)|\\1=\\"/myapplication/\\2|g"
Output fn="insert-filter" filter="sed-response" sed="s|https://
participant.myapplication.com|https://$urlhost:%OTD_HTTPS_PORT%/
myapplication|g"
</Object>
```

Name this file `object.conf` and place it in the common package directory. The package generation tool will create a new file in that directory with the generated prefix in its name.

### 54.7.3.3 Origin Server Pools (server.xml)

Name this file `server.xml` and place it in the common package directory.

The package generation tool will create a new file in that directory with the *generated* prefix in its name.

For example:

```
<origin-server-pool>
<name>origin-server-pool-participant-myapplication-com</name>
<family>inet</family>
<type>https</type>
<origin-server>
<host>participant.myapplication.com</host>
</origin-server>
</origin-server-pool>
```

#### 54.7.3.4 Routing Conditions (routes.conf)

Name this file `routes.conf` and place it in the common package directory. The package generation tool will create a new file in that directory with the *generated* prefix in its name.

For example:

```
<If $uri =~ "/myapplication">
NameTrans fn="assign-name" id="route-myapplication" name="route-
myapplication"
</If>
```

### 54.7.4 Generating the Customized Application Configuration Package

If you need to customize the application configuration package to a target environment, you need to use the `apspackageutility.jar` tool.

The tool is located in the following location in the Access Management suite installer archive:

```
../iamsuite/Disk2/stage/Components/oracle.oam.server/11.1.2.3.0/
1/DataFiles/Expanded/server/tools/apsapputility
```

The tool syntax is as follows:

---

---

**Note:**

The package generation tool requires an up-to-date Java Runtime Environment installation.

---

---

```
java -jar apsapputility.jar -p properties-file -z package-file or -d package-
directory
```

where:

- `-p properties-file` - full path and name of the property file to process (object.conf, server.xml, route.xml, or formfill.ini). This file contains the values for the properties listed in [Required Environment-Specific Configuration Data](#).

- `-z package-file` - full path and name of the package ZIP file (if using a ZIP file), or
- `-d package-directory` - full path to the directory containing the configuration files (if not using a ZIP file)

The `-z` and `-d` options are mutually exclusive; use only one or the other.

The tool will add the customized file(s) to the ZIP file or package directory, depending on the selected option; the names of the generated files will contain the `generated-` prefix. The generated file(s) will be output one directory up from where the source files are located.

## 54.7.5 Deploying the Customized Application Configuration Package

You can deploy the customized application configuration package.

To deploy:

1. Deploy the generated form-fill application policies (templates) and password generation policies, if defined (`generated-formfill.ini`). Log on to the Oracle Access Management Console, navigate to the **Applications** section and upload the file.
2. Deploy the generated rewriting rules (`generated-object.conf`).
  - a. Open the following file in a text editor:  
`target-otd-instance-directory/config/server-name-obj.conf`
  - b. Paste the contents of the `generated-object.conf` file inside the following tag:  

```
<Object name="default">
paste contents here
</object>
```
3. Deploy the generated origin server pool definitions (`generated-server.xml`):
  - a. Open the following file in a text editor:  
`target-otd-instance-directory/config/server.xml`
  - b. Paste the contents of the `generated-server.xml` file inside the following tag:  

```
<server>
paste contents here
</server>
```
4. Deploy the generated route conditions (`generated-routes.xml`):
  - a. Open the following file in a text editor:  
`target-otd-instance-directory/config/server-name-obj.conf`
  - b. Paste the contents of the `generated-routes.conf` file at the end of the file.

## 54.8 Password Generation Policies

Password policies facilitate user logons while ensuring the organization's security. The Access Portal Service lets administrators set policies that control automatic password generation.

Most applications have constraints for passwords: how long they can or must be, whether they must or must not include numbers or symbols, and so on. the Access Portal Service's password generation feature improves application logon security by automatically creating passwords made up of random characters according to predefined sets of constraints, stored as password policies. Each policy can apply to multiple applications or subscribers.

Using predefined password policies, you can completely automate password changes and implement sophisticated security schemes, including complex passwords and application-specific passwords unknown to users.

To manage password generation policies, click **Federation** at the top of the Administrative Console, then click **Password Generation Policies** in the **Access Portal Service** section. A new tab containing options to search and create opens.

**Figure 54-1 Password Generation Policies Search/Create Tab**

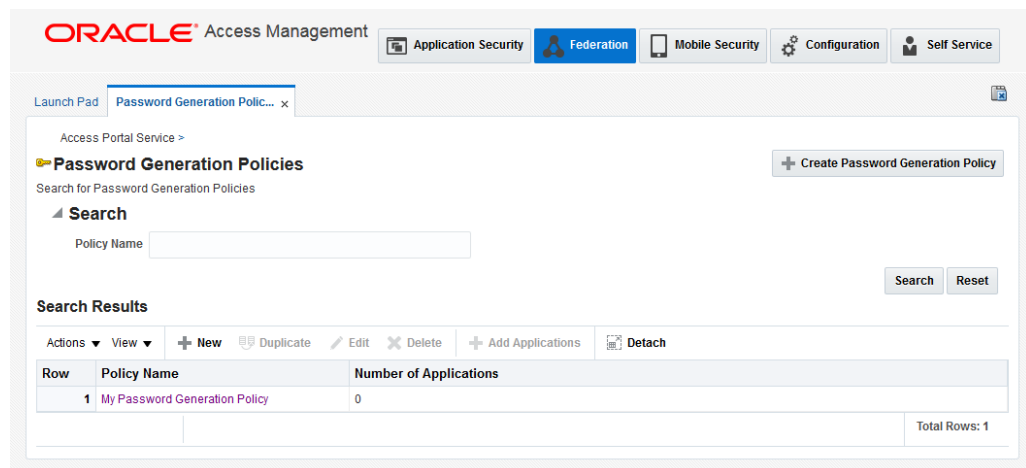

### 54.8.1 Searching for an Existing Password Generation Policy

You can search for an existing password generation policy.

To search:

1. Enter a name or partial string in the **Name** field, and click the **Search** button. The results appear in the **Search Results** table.
2. Click any policy in the **Search Results** list to edit the policy configuration. Continue to step 3 in the next section to learn more about configuring these settings.

### 54.8.2 Creating a New Password Generation Policy

You can create a new password generation policy.

To create a new password generation policy:

**Figure 54-2 New Password Generation Policy Summary Tab**

The screenshot shows the Oracle Access Management interface for creating a new password generation policy. The 'Summary' tab is active, displaying three input fields: 'Policy Name' (required), 'Description', and 'Reference'. Below the fields is an 'Applications' section with a table that is currently empty, showing 'No data to display.' The interface includes a 'Save' button and a 'Cancel' button in the top right corner.

1. Click the **Create Password Generation Policy** button to launch the **New Password Policy** tab, which contains two sub-tabs:
  - **Summary**
  - **Password Constraints**
2. On the **Summary** tab, enter the following information:
  - A distinct name for the policy.
  - (Optional) A meaningful description to identify the policy.
  - (Optional) Internal reference information describing the version/variant of the policy.
3. Click the **Password Constraints** tab.

**Note:**

If you would like to specify your password constraints using regular expressions, enter the desired REGEX string into the **Regular Expressions Constraint** field. Doing so will override and disable the manual constraint options listed below (except the **Previous Password Constraints** options).

4. On the **Password Constraints** tab, specify the following:
  - **Length Constraints**
    - The minimum password length. Options are 1-128. Default is 8 characters.
    - The maximum password length. Options are 1-128. Default is 8 characters.
  - **Alphabetic Characters**

- Check the box to allow uppercase characters. If you check the box, you must specify the minimum number required. Default is 0.
- Check the box to allow lowercase characters. If you check the box, you must specify the minimum number required. Default is 0.
- **Special Characters**
  - Check the box to allow non-alphabetical and/or non-numeric characters. If you check the box, you must specify the minimum and maximum number permitted. Default minimum is 0. Default maximum is 8.
  - Check the box(es) to allow a special character to start and/or end a password.
- **Excluded Characters**
  - Enter a list of specific characters to exclude from a password. Do not use any delimiters.
- **Repeat Constraints**
  - Enter the maximum number of times a given character can be repeated in a password (in any position). Options are 0-127. Default is 7.
  - Enter the number of times a given character can be repeated consecutively (adjacent to itself). Options are 0-127. Default is 7.
- **Numeric Characters**
  - Check the box to allow numeric characters. If you check the box, you must specify the minimum and maximum number permitted. Default minimum and maximum is 0.
  - Check the box(es) to allow a numeric character to start and/or end a password.
- **Other Characters**
  - Check to allow other characters to be included in a password.
- **Previous Password Constraints**
  - **Disallow use of previous password.** Check the box to prohibit reusing the previous password entirely.
  - **Limit use of previous password characters.** Select to limit repetition of characters from the previous password.
  - **Maximum previous password characters.** If you checked the previous box to permit usage of some previous password characters, select the maximum number of characters to allow.

**Note:**

The Access Portal Service recognizes multiple occurrences of a character as the same character and will therefore permit more than one occurrence of that character in the new password.

So, if the previous password contained three "A"s, and you specify that one character from the previous password can repeat, the Access Portal Service will allow more than one instance of "A" in the new password.

5. Click **Save** to complete policy configuration, or **Cancel** to close the tab without saving the policy.

**Figure 54-3 Password Constraints Tab of a Password Generation Policy**

The screenshot shows the 'Password Constraints' tab of a password generation policy configuration. The interface is divided into several sections:

- Regular Expression Constraint:** A text input field is empty. Below it, a note states: "Note: If you enter a regular expression constraint, most other password constraints will be reset and disabled."
- Length Constraints:**
  - \* Minimum password length: 8 (spinner)
  - \* Maximum password length: 8 (spinner)
- Alphabetic Characters:**
  - Allow uppercase characters:
  - \* Minimum uppercase characters: 0 (spinner)
  - Allow lowercase characters:
  - \* Minimum lowercase characters: 0 (spinner)
- Special Characters:**
  - Allow special characters:
  - Minimum special characters: 0 (spinner)
  - Maximum special characters: 0 (spinner)
  - Can start password:
  - Can end password:
- Previous Password Constraints:**
  - Disallow use of previous password:
  - Limit use of previous password characters:
  - Maximum previous password characters: 5 (spinner)
- Repeat Constraints:**
  - \* Maximum repeated non-consecutive characters: 7 (spinner)
  - \* Maximum repeated consecutive characters: 7 (spinner)
- Numeric Characters:**
  - Allow numeric characters:
  - Minimum numeric characters: 0 (spinner)
  - Maximum numeric characters: 0 (spinner)
  - Can start password:
  - Can end password:
- Other Characters:**
  - Allow other characters:
- Excluded Characters:** A text input field is empty.

### 54.8.3 Managing Policy Subscribers

Applications that use a password generation policy are called subscribers. You can add subscribers during creation of the policy or at any time thereafter. Following is the procedure to add subscribers to a policy.

To manage policy subscribers:

**Figure 54-4 Add Applications Dialog**

1. On the Password Generation Policy **Summary** page, click the **Add** icon. The **Add Applications** dialog appears.
2. In the **Name** field, enter a name or text string and click **Search**. You can also leave this field blank to return every available application.
3. After a search, all applications that fit your search criteria appear in the **Available Applications** list. For each application, the list includes any policy to which it subscribes.
4. Select one or more applications from the **Available Applications** list, and click **Add Selected**. Or simply click **Add All** to add every application returned by the search.

If you select an application that is already a subscriber to another policy, it will no longer be subscribed to the other policy.

5. Click **Add** when you are finished, or **Cancel** to dismiss the dialog without making changes.
6. Click **Save** to save your policy.

## 54.9 Managing Credential Sharing Groups

Credential sharing groups are sets of applications that share the information of one or more fields to facilitate account management, allowing users to apply a credential change made in one application to other specified applications automatically. For each Credential sharing group that you create, you can include any number of applications and designate which credentials they have in common.

When the Access Portal Service handles a credential change for any application that is a member of the sharing group, it automatically applies the credential change to all other group members. Any number or combination of applications can share a single credential. You can also designate a key field; that is, a field that the Access Portal Service uses when updating shared credentials, changing credentials only for accounts with the same key value.



**Note:**

Applications will share credentials only for their initial deployment unless you enable credential sharing groups.

the Access Portal Service provides flexibility and granularity for you to control how credential sharing groups work.

You can configure the following options:

- Sharing any or all fields for a group of applications:
- Pre-filling all shared fields when a user first encounters an application in a sharing group, thus requiring the user to enter information only for fields that are not shared by the group.
- Automatically creating an account when a user encounters an application for which all credentials are pre-determined.
- Designating a key field; that is, a field that the Administrative Console uses when updating shared credentials, changing credentials only for accounts with the same key value.

The next sections describe how to create new groups or edit existing ones. After you create a group, the process for configuring it is the same as editing an existing one.

### 54.9.1 Searching for a Credential Sharing Groups

You can search for a credential sharing group by entering a name or partial string.

To search:

1. Click **Federation** at the top of the Administrative Console, then click **Credential Sharing Groups** in the **Access Portal Service** section of the tab that appears.
2. Enter a name or partial string in the **Name** field, and click the **Search** button. The results appear in the **Search Results** table.
3. Click on any group in the **Search Results** list to edit its configuration. Continue to step 3 in the next section to learn more about configuring these settings.

**Figure 54-5** *Credential Sharing Groups tab*

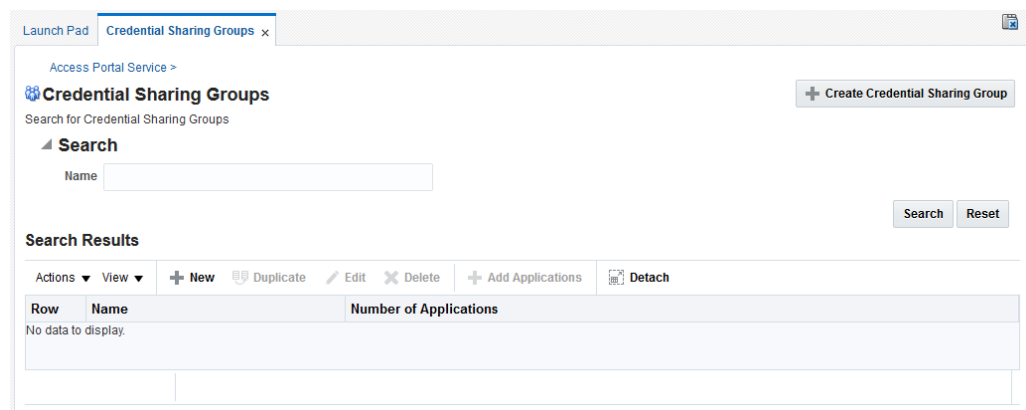

## 54.9.2 Creating a Credential Sharing Group

You can create a new credential sharing group.

To create:

1. Click the **Create Credential Sharing Group** button to launch the **New Credential Sharing Group** page.
2. In the **Name** field, enter a name for the group. Optionally, you can add a description and reference information in the fields at the bottom of this section.
3. In the **Shared credentials** settings, select which credentials the group will share. You can include any or all fields:
  - Username
  - Password
  - Third Field
  - Fourth Field
4. From the **Key Credential within group** dropdown, select a field. The key credential field provides more granular criteria for updating shared credentials within a group. When a credential changes, updates will only occur for members that share the key field. to update shared credentials only for accounts that share this field value.s only for accounts that share this field value.:

If the user wants to create an account that is not constrained by the key field, that account must have a new key field to avoid updating all existing accounts.

Choose one of the following from the dropdown:

- None (Default)
  - Username
  - Third Field
  - Fourth Field
5. If desired, select to pre-fill shared fields. This specifies that shared fields will be pre-populated with the shared credentials when the user creates a new account for an application. By default, this option is enabled.
  6. If desired, select to automatically create accounts when all credentials are known. This means that the Access Portal Service will create an account automatically when the user encounters an application that has all fields pre-determined.

---

---

**Note:**

This field is available only if **Key credential within group** is set to **None**.

---

---

7. Click **Save** to complete policy configuration, or **Cancel** to close the tab without saving the group.

**Figure 54-6 New Credential Sharing Group Page**

### 54.9.3 Managing Applications in Credential Sharing Groups

You can add applications to a group during creation of the group or at any time thereafter.

To add applications in credential sharing groups:

**Figure 54-7 Add Applications Dialog**

1. In the **Applications** section of the group page, click the **Add** icon. The **Add Applications** dialog appears.

2. In the **Name** field, enter a name or text string and click **Search**. You can also leave this field blank to return every available application.
3. After a search, all applications that fit your search criteria appear in the **Available Applications** list. For each application, the list includes any credential sharing group to which it belongs.
4. Select one or more applications from the **Available Applications** list, and click **Add Selected**. Or simply click **Add All** to add every application returned by the search.

If you select an application that is already a member of another group, it will no longer be part of that group.

5. Click **Add** when you are finished, or **Cancel** to dismiss the dialog without making changes.
6. Click **Save** to store the changes made to the credential sharing group.

## 54.10 Managing Global Agent Settings

Global Agent Settings determine single sign-on behavior when users encounter password-protected applications. With these settings you specify what the user sees and is allowed to do when navigating to an application.

The next sections describe how to create new sets of Global Agent Settings or edit existing sets. You can use existing sets created in the the Access Portal Service, or import preconfigured settings in the format of INI files. After you create a set, the process for configuring it is the same as that for editing an existing one.

### 54.10.1 Searching for Sets of Global Agent Settings

You can search for an existing set of Global Agent Settings.

To search:

1. Click **Federation** at the top of the Administrative Console, then click **Global Agent Settings** in the **Access Portal Service** section.
2. Enter a name or partial string in the **Name** field, and click the **Search** button. The results appear in the **Search Results** table.
3. Click on any group in the **Search Results** list to edit its configuration. Continue to step 3 in [Creating a Set of Global Agent Settings](#) to learn more about configuring these settings.

**Figure 54-8 Global Agent Settings Search tab**

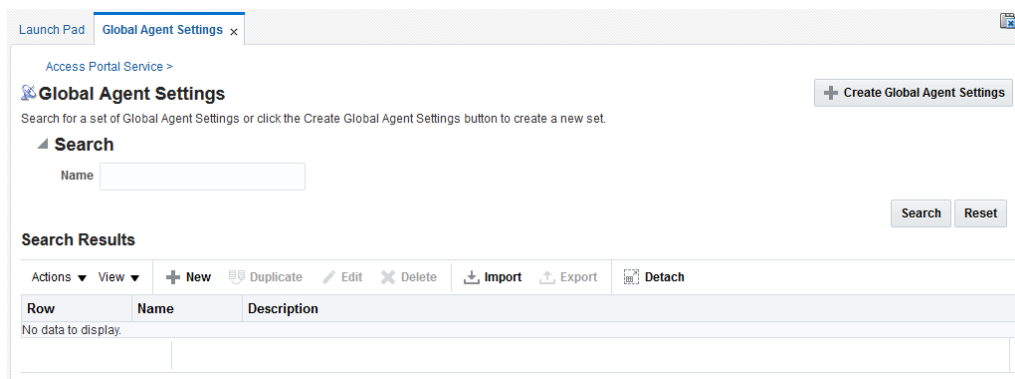

## 54.10.2 Importing an INI File with a Global Agent Settings Configuration

You can import an INI file (unicode format only) with a Global Agent Settings Configuration.

To import:

1. Click the **Import** icon to launch the **Import Global Agent Settings** dialog, and click the **Browse** button.
2. Navigate to an existing INI file, select it and click **Open**. Then click the **Update** button. The Global Agent Settings' configuration page opens. Continue to step 3 in the following topic to learn more about configuring these settings.

See [Creating a Set of Global Agent Settings](#).

## 54.10.3 Creating a Set of Global Agent Settings

You can create a new set of global agent settings configuration.

To create:

**Figure 54-9 New Global Agent Settings Page**

1. Click the **Create Global Agent Settings** button to launch the Create Global Agent Settings page.
2. In the **Name** field, enter a name for the group. Optionally, you can add a description of this set.
3. In the **Credential Field Identification** settings, specify the following:
  - Whether to display a highlighted border around the credential fields of an application during logon. The default is to show the border.
  - The default border color/size/style for highlighting detected web page fields. The default is a solid red border, six pixels in width.

Following is an example of the results of using the default settings for this group.



4. In the **Behavior** settings, specify the following:

- **URL Matching Precision.** The number of levels of the host portion of the URL used for application detection and response. Default is 2.

For example, for the URL `http://mail.company.co.uk`:

2=match to `*.co.uk`

3=match to `*.company.co.uk`

4=match to `*.mail.company.co.uk`

---

**Note:**

Values less than 2 are treated as 2.

---

- **Scroll into View.** Enables or disables scrolling the browser window to bring the logon fields into view. Default is No.  
This setting disables scrolling when the user has not yet stored credentials for a Web application. Scrolling always occurs when injecting credentials into the logon fields for an account that already exists.

5. In the **Password Change Behavior** settings, select a **Default Password Policy** from the dropdown list, if desired. Default is None.

6. In the **Response Control** settings:

- Enter the list of **Web pages to Ignore**. This is typically used when the BHO causes conflicts with specific Web applications or sites. Click the ellipsis ("...") button to enter the regular expressions that match the URLs to be ignored (one per line).

**Examples:**

- `.*http://login\.company\.com/.*`
- `.*http://.*\.company\.com/.*`

- Enter the list of **Allowed Dynamic Web Pages**. Use this setting to list the permissible dynamic (DHTML) Web pages. By default, the BHO does not detect changes made to a dynamic page after the initial presentation of the page.

**Examples:**

- `.*http://login\.company\.com/.*`

– \*.http://.\*\company\.com/\*.\*

7. In the **Allowed Character Sets** settings, enter the permissible characters for each of the four types of fields. The fields are pre-populated with the defaults for each character set.
8. In the **Masked Fields Security** settings, specify the following.
  - **Obfuscate Length.** Specifies whether to display encrypted fields with a string of blank characters different from the length of the obfuscated data. Default is Yes.
  - **Allow Revealing.** Specifies whether the user is permitted to reveal masked fields. Default is Yes.
  - **Require Reauthentication to Reveal.** Specifies whether the user must enter the Access Portal Service credentials in order to reveal masked fields, assuming that you have set **Allow revealing** to **Yes**. Default is Yes.
9. In the **Authentication** section, specify the naming attribute string for the target data repository (if required by your environment). For more information, see the *Enterprise Single Sign-On Suite Administrator's Guide*.
10. Click **Save** to complete global agent setting configuration, or **Cancel** to close the tab without saving the set.



# Part XIV

---

## Using Identity Context

Identity Context is considered as the environment and circumstances surrounding a user's request to access a particular protected resource.

It can be a sphere of activity, a geographical region, a communication platform, an application, or a logical or physical domain. Here is an introduction to Oracle Identity Context. This section contains the following chapter:

- [Using Identity Context](#)



---

## Using Identity Context

Identity Context allows organizations to meet growing security threats by leveraging the context-aware policy management and authorization capabilities built into the Oracle Access Management platform.

Identity Context secures access to resources using traditional security controls (such as roles and groups) as well as dynamic data established during authentication and authorization (such as authentication strength, risk levels, device trust and the like).

This section describes the following topics:

- [Introducing Identity Context](#)
- [Understanding Identity Context](#)
- [Working With the Identity Context Service](#)
- [Identity Context API](#)
- [Configuring the Identity Context Service Components](#)
- [Validating Identity Context](#)

### 55.1 Introducing Identity Context

Identity Context is considered the environment and circumstances surrounding a user's request to access a particular protected resource. It can be a sphere of activity, a geographical region, a communication platform, an application, or a logical or physical domain.

Over the last decade, changes have been made to enterprise application infrastructures in order to web-enable the business applications that these infrastructures support. The changes allow for access by a greater number of users using different types of devices. To compensate for the additional risk associated with the greater number of users, the underlying security models used for access management have evolved from a silo-based implementation to a more dynamic one in which identity and risk data is shared across components of the entire application delivery process. This dynamic implementation relies on systems that offer Web single sign-on (SSO), fine-grained authorization, Web Services Security, Identity Federation and the like to aggregate security controls within a particular run-time deployment environment (web server or application server container) and provide policy-based security controls to manage access to application resources. Additionally, the identity and risk data provides a context for the user who is requesting access.

Initially, application security controls focused on unifying silos within a specific enterprise application deployment paradigm (for example, all web server applications, all web services applications, or all application server applications) but a growing presence of external and internal security threats now requires the unification of disparate security models in order to properly manage the greater amount of risk.

This requirement is further magnified by the advent of the cloud and mobile computing paradigm in which applications are no longer made up of components running neatly in the protected confines of a secure enterprise.

The ability of applications to leverage cloud services comes at the cost of having to account for the greater amount of risk stemming from those services being silos in their own way. With the number of threats to cloud deployments and mobile delivery channels growing steadily, it is required for the end-to-end application delivery process to implement the necessary policy controls for dealing with the greater range of threats. These policy controls require access to information about the requesting user on the basis of which security decisions must be made. Thus, a security policy management infrastructure must be context-aware to allow for an Administrator to create policy that controls the level of security imposed on a user who is requesting access to a protected application environment.

Previously, Identity Context was defined by the presence of an identity record in one or more identity stores (such as an LDAP directory or a SQL database). The identity record includes profile attributes, groups of which the user is a member, and enterprise roles. However, the constantly expanding reach of web, cloud, and mobile application delivery channels requires authorization policy controls that are aware of more dynamic information regarding the identity. This information is associated with the identity attempting to access the protected resource and may include some or all of the following:

- Presence (location, historical patterns)
- Authentication strength (weak, strong)
- Level of Assurance (NIST levels, X509 certificates)
- Risk Assessment (pattern analysis)
- Federation (partner attributes)
- Device characteristics (fingerprint, device health, device protection, trusted data)
- Assertions from trusted partners (SAML tokens, etc.)
- Single Sign On sessions (session time outs)

The following examples illustrate how Identity Context data might be used by an application. The application might:

- Disable a particular business function if the user is not authenticated using a strong credential such as smart card.
- Secure access to a transaction based on the identity data supplied by a business partner (via Identity Federation) with whom the organization does business.
- Request additional authentication credentials if it detects that access is originating from a location known for fraudulent activities.
- Limit the scope of administrative authority if the Administrator's industry certification (as maintained by a third party) has expired.
- Disable certain business functions if it detects that access is originating from an unknown device.

By incorporating the concept of Identity Context into access management, control can now be determined using dynamic data that is not necessarily contained in an identity profile (referred to as Identity Context attributes).

## 55.2 Understanding Identity Context

Access Manager enables context-aware access management by incorporating Identity Context as a built-in service of the Oracle Access Management platform.

Figure 55-1 illustrates the flow of the Identity Context process, implemented by multiple system components. Each application delivery component has its own security policy infrastructure responsible for protecting its individual slice of the application. This specific use case involves the end user device, a Web Server running static GUI pages, an Application Server running the Portal Server rendering dynamic content, a Service Bus Server exposing the Web service endpoint, a database server containing transactional data, and an LDAP server containing identity profile data.

**Figure 55-1 End to End Identity Context Process**

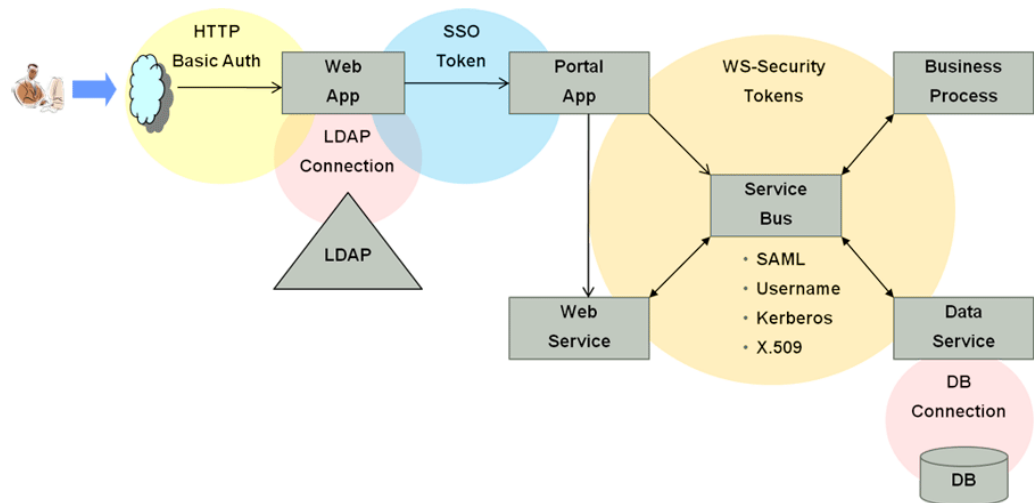

Each component of the process has its own security infrastructure where the authorization policies governing access to protected resources are defined administratively and enforced at runtime. Additionally, some or all of the components may have externalized policy management to an external authorization server such as Oracle Entitlements Server - which is the case if the applications were built leveraging Oracle Platform Security Services. Figure 55-2 illustrates the functional architecture of Identity Context based on the Oracle applications of which it is comprised.

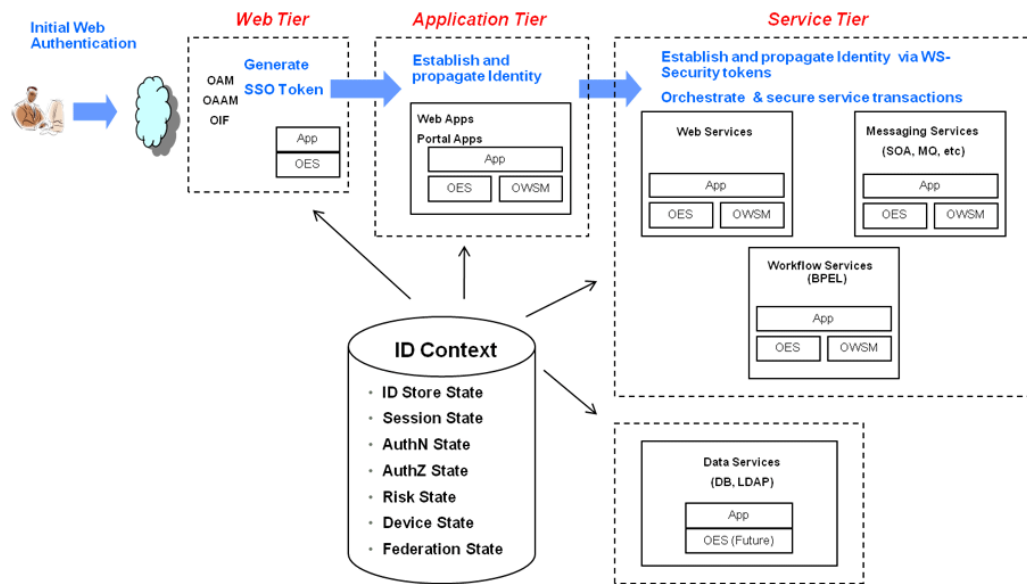
**Figure 55-2 End To End Identity Context Process Components**

As seen in the illustrations, context-aware security policy management is achieved by leveraging the Oracle Access Management platform. This platform contains native support for working with and enforcing Identity Context attributes (including risk score, trusted device data, authentication data, and the like) without changing end-user applications.

## 55.3 Working With the Identity Context Service

The Oracle Access Management platform enables Identity Context data to be collected, propagated across the involved components, and made available for granting or denying authorization to access protected resources.

For more information, see [Figure 55-2](#). The Identity Context Service allows access to the Identity Context Runtime through the Identity Context API. The Identity Context Dictionary schema specifies the Identity Context attributes.

This section describes the following topics:

- [Identity Context Dictionary](#)
- [Identity Context Runtime](#)

### 55.3.1 Identity Context Dictionary

At the core of the Identity Context architecture is the Identity Context Dictionary. The dictionary defines the Identity Context schema by specifying the identity context attributes as defined by the Oracle Access Management platform.

The Schema describes each attribute with a unique name that equals *namespace : attribute*. [Table 55-1](#) documents the Schema attributes.

**Note:**

Virtual attributes (as documented in [Table 55-1](#)) represent an abstract class of identity information from which specific attributes are created. When publishing virtual attributes, the Identity Context API expects the attribute value to contain *attr-name=attr-value*. The actual attribute will be created using the name *namespace : attribute : attr-name* and a value of *attr-value*. This approach allows the publication of attributes whose value comes from a source not directly managed by the Oracle Access Management components.

**Table 55-1 Identity Context Schema Attributes**

Namespace	Attribute	Type	Virtual	Primary Publisher	Description
oracle:ldm:claims:nameid	value	string	no	OAM	Indicates a unique user identifier. Access Manager currently publishes User DN
oracle:ldm:claims:nameid	format	string	no	OAM	Indicates the type of user identifier. Access Manager currently publishes "urn:oasis:names:tc:SAML:1.1:nameid-format:x509SubjectName"
oracle:ldm:claims:nameid	qualifier	string	no	OAM	Indicates a logical Identity Domain to whom the user belongs. Access Manager currently publishes a logical name of the identity store, such as UserIdentityStore1.
oracle:ldm:claims:nameid	sprovidedid	string	no	OAM	Indicates unique identifier that can be used by any SP to locate the user in SP's own identity store(s). Access Manager currently publishes the value of the unique id attribute as configured in a registered identity store.
oracle:ldm:claims:client	firewallenabled	boolean	no	OESSO	Indicates client device has firewall enabled.
oracle:ldm:claims:client	antivirusenabled	boolean	no	OESSO	Indicates client device has antivirus enabled.
oracle:ldm:claims:client	fingerprint	string	no	OESSO, Oracle Access Management Mobile and Social (OMS)	Indicates fingerprint of the client device.

**Table 55-1 (Cont.) Identity Context Schema Attributes**

Namespace	Attribute	Type	Virtual	Primary Publisher	Description
oracle:ids:claim	ostype	string	no	OMS	Indicates client device's Operating System type.
oracle:ids:claim	osversion	string	no	OMS	Indicates client device's operating system version.
oracle:ids:claim	jailbroken	boolean	no	OMS	Indicates if client device is Jailbroken (iOS) or Rooted (Android).
oracle:ids:claim	macaddress	string	no	OMS	Indicates client device's Ethernet (MAC) Address.
oracle:ids:claim	ipaddress	string	no	OMS	Indicates client device's Client IP Address.
oracle:ids:claim	vpnenabled	boolean	no	OMS	Indicates if client's device has VPN enabled.
oracle:ids:claim	geolocation	string	no	OMS	Indicates client device location's geographical coordinates in the form of "latitude,longitude".
oracle:ids:claim	newdevice	boolean	no	OAAM	Indicates if the client device has been seen before. True when logging in from a device never seen before; otherwise, false.
oracle:ids:claim	level	integer	no	OAAM	Indicates risk level. Level increases after unsuccessful logins.
oracle:ids:claim	safeuser	boolean	no	OAAM	Indicates if the user answered a secondary challenge question. True after the user successfully answers it; otherwise false.
oracle:ids:claim	fingerprint	string	no	OAAM	Indicates device fingerprint as measured by OAAM. Different devices will leave different fingerprints; can be switched between device (obtained via Flash) fingerprint and browser (http-only) fingerprint
oracle:ids:claim	authnlevel	integer	no	OAM	Indicates authentication level for Access Manager
oracle:ids:claim	usercount	integer	no	OAM	Indicates number of sessions held by the users



**Table 55-1 (Cont.) Identity Context Schema Attributes**

Namespace	Attribute	Type	Virtual	Primary Publisher	Description
oracle:ldm:claim s:session	appdomain	string	no	OAM	Indicates name of the Access Manager Application Domain containing policies
oracle:ldm:claim s:session	apppolicy	string	no	OAM	Indicates name of the Access Manager policy that allowed access
oracle:ldm:claim s:session	appagent	string	no	OAM	Indicates the name of the agent from which the request came to Access Manager
oracle:ldm:claim s:session	appclientip	string	no	OAM	Indicates the IP address of the client sending the request to Access Manager
oracle:ldm:claim s:session	sessionid	string	no	OAM	Indicates the Access Manager session ID
oracle:ldm:claim s:session	attributes	string	yes	OAM	Indicates session attributes as retrieved from the session store. For example, in Access Manager, select "oracle:ldm:claims:session:attributes" as the claim name and then specify the session attribute using the following notation: " <i>attr-name</i> =\$session.attr. <i>name</i> " where <i>name</i> is the name of the attribute stored in the session. The claim will be created with the name of "oracle:ldm:claims:session:attributes: <i>attr-name</i> " and value equal to session's <i>name</i> attribute.
oracle:ldm:claim s:fed	partner	string	no	OAM--or IF?	Indicates partner ID as determined by Identity Federation
oracle:ldm:claim s:fed	nameidvalue	string	no	OAM--or IF?	Indicates user ID from a federation partner as determined by Identity Federation
oracle:ldm:claim s:fed	nameidformat	string	no	OAM--or IF?	Indicates format of the user ID from a federation partner as determined by Identity Federation

**Table 55-1 (Cont.) Identity Context Schema Attributes**

Namespace	Attribute	Type	Virtual	Primary Publisher	Description
oracle:ldm:claim s:fed	attributes	string	yes	OAM	Indicates federation attribute as supplied by the partner and determined by Identity Federation. For example, in Access Manager, select "oracle:ldm:claims:fed:attributes" as the claim name and then specify the federation attribute using the following notation: " <i>attr-name</i> =\$session.attr.fed.attr. <i>name</i> ", where <i>name</i> is the name of the SAML attribute in the partner's SAML assertion. The claim will be created with the name of "oracle:ldm:claims:fed:attributes: <i>attr-name</i> " and value equal to the partner's assertion provided in the SAML's <i>name</i> attribute.
oracle:ldm:claim s:ids	attributes	string	yes	OAM	For example, in Access Manager, select "oracle:ldm:claims:ids:attributes" as the claim name, and then specify the ID Store attribute using the following notation: " <i>attr-name</i> =\$user.attr. <i>name</i> " where <i>name</i> is the name of the attribute on the user profile. The claim will be created with the name of "oracle:ldm:claims:ids:attributes: <i>attr-name</i> " and value equal to user profile's <i>name</i> attribute.
oracle:ldm:claim s:tenant	tenantid	string	no	OAM	Currently reserved for future use. (Indicates tenant id.)
oracle:ldm:claim s:tenant	attributes	string	yes	OAM	Currently reserved for future use. (Indicates tenant attributes as supplied by the Publisher. The claim value is meant to contain " <i>attr-name=attr-value</i> ". The claim will be created with the name of "oracle:ldm:claims:tenant: <i>attr-name</i> " and value of <i>attr-value</i> .)

## 55.3.2 Identity Context Runtime

Identity Context Runtime refers to a collection of Identity Context attributes (as defined in the Identity Context Dictionary) that is asserted by various trusted application components and/or security frameworks known to be authoritative for the attributes; this is the Oracle Access Management platform. Runtime context represents current surroundings, circumstances, environment, background, or settings which determine, specify, or clarify the meaning of an event for an identity in the runtime application environment.

The Oracle Access Management platform leverages a common infrastructure component called the Context Management Engine (CME). CME ensures that an Identity Context is generated for every transaction that is processed through the Oracle Access Management platform. The context data gathered by CME applies to transactions a user performs over the web channel or web service channel and using many of the software products available in the Oracle Access Management platform. Some transactions that are initiated on the back end may also require access to Identity Context, and may require Identity Context to be persisted for some duration of time.

In a typical Oracle middleware deployment the Identity Context Runtime will be utilized primarily by the Oracle Access Management platform to perform policy-based decisions on behalf of protected applications. However, it is also possible for any applications running in the container to directly integrate with, and consume, the Identity Context Runtime by leveraging the Identity Context API. The amount of available Identity Context data will vary depending on what products have been deployed. There will be a default set of Identity Attributes that will be available out-of-the-box, which are mainly configured in the Access Manager by leveraging the Identity Assertion. [Table 55-1](#) documents these default attributes. The following list provides details on the end-to-end flow of the Identity Context Runtime. [Figure 55-3](#) below the list illustrates the flow.

Process overview: End-to-end flow of the Identity Context Runtime

1. User accesses a protected application from a device.
2. Access Manager asserts the identity, collects Identity Attributes from the participating Access Management publishing components and creates an Identity Context.
3. Access Manager generates an Identity Assertion (a SAML Session token) and incorporates the Identity Context attributes. The Access Manager Identity Asserter processes the Identity Assertion and publishes the Identity Context to the WebLogic Server container using the OPSS Attribute Service.
4. The protected application calls the OES PEP API to make an authorization decision. OES automatically propagates the Identity Context to the local OES PDP.
5. OES finds the appropriate Authorization Policy and evaluates it's Conditions (based on the Identity Context attributes). Evaluation can be done using a built-in Identity Context function or a custom function.
6. The protected application makes a JRF web service call in which the Oracle Web Service Manager (OWSM) client uses the SAML token to propagate Identity Context into the Web Service application environment.

7. OWSM (on the web service side) processes the SAML assertion with the Identity Context and publishes the Identity Context to the WebLogic Server container by using the OPSS Attribute Service.
8. Web Service application calls OES PEP API to make an authorization decision.
9. OES automatically propagates Identity Context to the remote OES PDP where conditions based on Identity Context attributes are evaluated using a built-in Identity Context function or a custom function.

**Figure 55-3 Identity Context Process Flow**

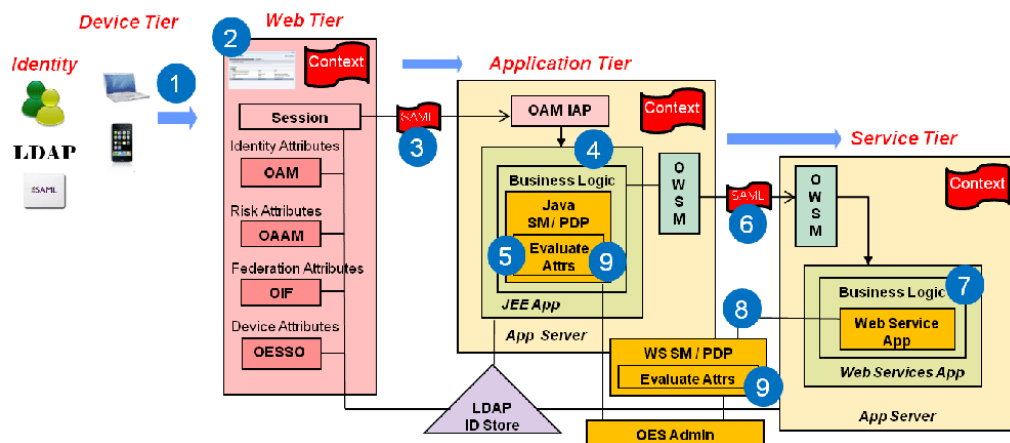

Once CME propagates Identity Context into the application tier and underlying Application Server container, the Identity Context is then made available to the container and applications running in it. Table 55-2 documents which Access Management platform products do what when working with Identity Context.

**Table 55-2 Mapping Identity Context Operations**

Role and Context Operation	Description	Components
Publisher - publishes Identity Context	Trusted security framework protecting an application component obtains from another trusted security framework, or derives from the information available to it, suitable facts about the identity and/or identity's access request.  The information collected by the authoritative component is based on the environmental context available to component's runtime framework. For example, Access Manager determines the user's level of authentication strength, OAAM computes the risk score associated with a specific online session, and OESSO determines whether or not the client device has a firewall enabled.	<ul style="list-style-type: none"> <li>• OAM – Session, Federation, and identity store attributes</li> <li>• OAAM – Risk attributes</li> <li>• OESSO – Device attributes</li> <li>• OMS Mobile SDK - Device attributes</li> </ul>

**Table 55-2 (Cont.) Mapping Identity Context Operations**

Role and Context Operation	Description	Components
Propagator - propagates Identity Context	Trusted security framework propagates Identity Context attributes for use by another application security framework or directly by the application. For example, OAAM propagates user's risk score into the Access Manager session for the user, Access Manager propagates Identity Assertion (SAML token) for with the authenticated user's unique id and authentication level, and OWSM client propagates the current Identity Context over to the web service where OWSM agent will rebuild Identity Context in the web service application.	<ul style="list-style-type: none"> <li>• OAM is between Web tier and container tier</li> <li>• OWSM is between web service client tier and web service tier</li> <li>• OPSS is between Access Manager Identity Asserter or OWSM agent and WebLogic Server container</li> <li>• OMS is between the OMS Mobile SDK and Access Manager</li> </ul>
Evaluators - evaluate Identity Context	Trusted security framework or end-user application using Identity Context attributes to perform policy decisions or personalize application business logic. For example, when OAAM is present and configured to compute the risk score, the application's authorization policy in OES allows access only when the risk score is under a certain threshold. Also, when Identity Federation in Access Manager is configured, the application uses a partner-supplied assertion (available in the Identity Context) to authorize access to a transaction using OES.	<ul style="list-style-type: none"> <li>• OAM – Web Perimeter Policy</li> <li>• OWSM – Web Service policy</li> <li>• OES – App-specific or WLS-specific policy for all PEP API calls made from the container where Identity Context exists. This includes all ADF apps, IAM apps, custom apps, etc.</li> </ul>

## 55.4 Identity Context API

The Identity Context API is a set of Java classes designed to work with the Identity Context Dictionary and Identity Context Runtime.

The API is delivered as `IdentityContext.jar`, a part of Oracle Java Required Files (JRF). The following example illustrates an application working with Identity Context Dictionary.

Exmaple 55-1: Working with Identity Context Dictionary

```
// Display Identity Context Dictionary
try {
 ClaimDictionary idCtxDict = new ClaimDictionary();
 System.out.println
 ("IDC Dictionary : " + idCtxDict.getClaimCount() + "attributes");
 Iterator<String> iterNamespace = idCtxDict.getAllNamespaces();
 while (iterNamespace != null && iterNamespace.hasNext()) {
 String namespace = iterNamespace.next();
 System.out.println("Namespace : " + namespace);
 Iterator<ClaimSchema>
 iterClaimSchema=idCtxDict.getClaimsForNamespace(namespace);
 while (iterClaimSchema != null && iterClaimSchema.hasNext()) {
 out.println(iterClaimSchema.next().getUniqueName());
 }
 }
}
```

```
 }
 } catch (Exception e) {
 System.out.println("Unable to acquire IDC Dictionary. " + toString());
 }
}
```

Applications work with the Identity Context Runtime to obtain the runtime state of the Identity Context as it currently exists in the application infrastructure. In order to work with the Identity Context Runtime, the protected application must be deployed to either a WebLogic Server domain built on Oracle Fusion Middleware PS5 with the OPSS Opatch for PS5, or Oracle Fusion Middleware PS6 or later.

Additionally, working with the Identity Context Runtime is a privileged operation that requires applications running in the WebLogic Server (with the required Identity Context support) to have proper source code grants. The privileged application, running in the WebLogic Server container, can then access the Identity Context Runtime by requesting it from the OPSS Attribute Service. The following example demonstrates how to use WLST to grant the OPSS Attribute Service permission to access an application (in this case, `ssofilter.jar`).

#### Using WLST To Grant Attribute Service Access To Application

```
sh ../oracle_common/common/bin/wlst.sh
connect ('<username>', '<password>', 't3://localhost:7001')
grantPermission(codeBaseURL="file:${common.components.home}/
 modules/oracle.ssofilter_11.1.1/ssofilter.jar",
permClass="oracle.security.jps.service.attribute.AttributeAccessPermission",
 permTarget="*", permActions="get, set, remove")
exit()
```

The following example illustrates an application working with Identity Context Runtime.

#### Working with Identity Context Runtime

```
import java.security.AccessController;
import java.security.PrivilegedAction;
import oracle.security.jps.internal.api.runtime.AppSecurityContext;
import oracle.security.idm.IdentityContext;

...

// get runtime ID Context from OPSS
private static Object getIDContext() {
 Object idc = AccessController.doPrivileged(new PrivilegedAction<Object>() {
 public Object run() {return
AppSecurityContext.getSecurityContext().getAttribute
 (oracle.security.idm.IdentityContext.Constants.IDC_API_ID); }});
 return idc;
}

...

// Display runtime ID Context
try {
 Context idCtx = (Context)getIDContext();
 if (idCtx != null) {
 System.out.println("IDC Runtime : " + idCtx.getSize() + "attributes");
 Iterator<Claim> i = idCtx.getClaims();
 while (i != null && i.hasNext()) {
 Claim c = i.next();
 System.out.println(c.getName() + " : " + c.getValue());
 }
 }
}
```

```

 }
 } else {
 System.out.println("Identity Context Runtime is not available");
 }
} catch (Exception e) {
 System.out.println("Unable to acquire Identity Context Runtime. " + e.toString());
}
}

...

// Obtain few attributes from Identity Context Runtime
Attr authnLevel = ctx.getAttr (Constants.ATTR_SESSION_AUTHN_LEVEL);
Attr isFirewallEnabled = ctx.getAttr(Constants.ATTR_CLIENT_FIREWALL_ENABLED);
Attr isTrustedDevice = ctx.getAttr(Constants.ATTR_RISK_TRUSTED_DEVICE);

// Use user's authentication strength established at login by OAM
int authnLevel = new Integer(authnLevel.getValue()).intValue();
if (authnLevel < 20) {
 // do something
}
}

```

## 55.5 Configuring the Identity Context Service Components

Each Identity Context Service component must be configured to accommodate business requirements. Support for Identity Context is pre-integrated into each participating Oracle Access Management component. A high-level overview of the necessary Identity Context configurations is provided here. However, detailed information can be found in documentation accompanying individual products.

See [Table 55-2](#)

This section describes the following topics:

- [Configuring Oracle Fusion Middleware](#)
- [Configuring Access Manager](#)
- [Configuring Oracle Adaptive Access Manager](#)
- [Configuring Web Service Security Manager](#)
- [Configuring Oracle Entitlements Server](#)
- [Configuring Oracle Enterprise Single Sign On](#)
- [Configuring Oracle Access Management Mobile and Social](#)

### 55.5.1 Configuring Oracle Fusion Middleware

The application to be protected must be deployed in a WebLogic Server domain built on Oracle Fusion Middleware 11.1.1 patch set 5 (PS5) with the Oracle Platform Security Services (OPSS) Opatch for PS5 or, Oracle Fusion Middleware PS6 or later.

The WebLogic Server domain in which the application is running must be protected by the Access Manager Identity Asserter component that will validate the Identity Assertion received from Access Manager and start the process of creating the Identity Context Runtime. The Access Manager Identity Asserter must be configured to detect the token type, OAM\_IDENTITY\_ASSERTION. Also, the protected application working with the Identity Context Runtime directly must be granted source code grants to work with the OPSS Attribute Service.

---

---

**See Also:**

*Securing Applications with Oracle Platform Security Services* for more information on configuring Access Manager Identity Asserter, as well a source code grants.

---

---

## 55.5.2 Configuring Access Manager

As the main publisher and propagator of Identity Context, OAM serves as the central configuration point for collecting Identity Context data from its participating components.

The following sections describe key elements of the architecture behind Identity Context management.

- [Identity Assertion](#)
- [Federation Attributes](#)
- [Session Attributes](#)
- [Identity Store Attributes](#)

### 55.5.2.1 Identity Assertion

Oracle recommends that you define Asserted Attributes in Access Manager Authorization policies for proper enforcement of end-to-end security between the Web and application tiers. In addition to ensuring trust between the WebGate protecting a Web resource and the Application Server container, Identity Assertion (a SAML Session token) is used to publish the Identity Context data as SAML attributes.

Identity Assertion must be enabled and populated with Asserted Attributes as required by the business logic expecting specific attributes in the Identity Context. It is configured within the OAM Policy Responses tab and can be defined for both Authentication and Authorization policies.

---

---

**See Also:**

Access Manager Identity Assertion and Asserted Attributes ([Table 25-25](#)).

---

---

### 55.5.2.2 Federation Attributes

Once a resource is protected by the Access Manager authentication scheme FederationScheme, Access Manager will act as the service provider and receive the SAML assertion as provided by the federation partner.

After the federation single sign on (SSO) operation, the following attributes will be present in the authenticated identity's Access Manager session:

- `$session.attr.fed.partner` (contains the partner name)
- `$session.attr.fed.nameidvalue` (contains the SAML NameID Value)
- `$session.attr.fed.nameidformat` (contains the SAML NameID Format)
- one `$session.attr.fed.attr.name` entry per SAML Attribute (contained in the SAML Assertion received from the partner)



These federation attributes can be used in configuring an Identity Assertion by selecting `oracle:ldm:claims:fed:attributes` as the Asserted Attribute, and setting the value to `"attr-name=$session.attr.fed.attr.name"` where `attr-name` is the name given to the Identity Context attribute and `name` is the name of the SAML attribute in the partner's SAML assertion.

For example, defining `oracle:ldm:claims:fed:attributes` with the value of `partner-role=$session.attr.fed.attr.role` will result in the creation of the Identity Context attribute `oracle:ldm:claims:fed:attributes:partner-role` having a value of "manager" (assuming `$session.attr.fed.attr.role` contains "manager" as specified in the partner's SAML assertion for the SAML attribute "role").

### 55.5.2.3 Session Attributes

Access Manager session attributes can be used in configuring Identity Assertion by selecting `oracle:ldm:claims:session:attributes` as the Asserted Attribute and setting the value to `"attr-name=$session.attr.name"` where `attr-name` is the name given to Identity Context attribute and `name` is the name of the Access Manager session attribute.

For example, defining `oracle:ldm:claims:session:attributes` with the value of `authn-strength=$session.attr.authnlevel` will result in the creation of the Identity Context attribute `oracle:ldm:claims:session:attributes:authn-strength` having a value as defined by the authentication scheme used during the login process.

### 55.5.2.4 Identity Store Attributes

Identity Store attributes can be used to configure an Access Manager Identity Assertion by selecting `oracle:ldm:claims:ids:attributes` as the Asserted Attribute and setting the value to `"attr-name=$user.attr.name"` where `attr-name` is the name given to the Identity Context attribute and `name` is the name of the Identity Store attribute.

For example, defining `oracle:ldm:claims:ids:attributes` with the value of `first-name=$user.attr.fname` will result in the creation of the Identity Context attribute `oracle:ldm:claims:ids:attributes:first-name` having a value from the user's `fname` attribute as maintained in the identity store.

## 55.5.3 Configuring Oracle Adaptive Access Manager

As part of the integration between Oracle Access Manager and Oracle Adaptive Access Manager (OAAM), OAAM publishes and propagates risk-based Identity Context attributes.

In this case, OAAM attributes are passed to OAM at the end of user authentication flow (on the OAAM side) in a DAP Token. The DAP Token will carry attributes as defined by the `oracle:ldm:claims:risk` namespace in [Table 55-1](#). OAM then pushes these attributes into the `$session.risk.attr` namespace. The following sections contain information regarding configuration of OAAM and OAM.

- [Setting Up Oracle Adaptive Access Manager](#)
- [Configuring Access Manager for OAAM Integration](#)
- [Validating Identity Context Data Published by OAAM](#)

### 55.5.3.1 Setting Up Oracle Adaptive Access Manager

You can install and set up Oracle Adaptive Access Manager.

This section contains information on installing and setting up OAAM.

To setup Oracle Adaptive Access Manager

1. Set up OAAM by importing snapshots.

See for details.

2. Integrate OAAM and Access Manager as documented in the .

The TAP token version must be v2.1 and not v2.0.

3. Ensure that the following properties are set to true.

- `oracle.oaam.idcontext.enabled` is true by default; use the OAAM Administration Console to change the value.
- `bharosa.uio.default.registerdevice.enabled` must be true for proper operation of the 'safeforuser' claim.

4. From the OAAM Administration Console, go to Properties, Create New Property.

5. Enter the property name `oaam.uio.oam.dap_token.version` with a value equal to `v2.1`.

6. Restart `oaam_server_server1`.

### 55.5.3.2 Configuring Access Manager for OAAM Integration

You can configure Access Manager for the Integration with OAAM.

Perform the following steps using the TAPScheme forces the user to authenticate using the OAAM authentication schemes.

---

---

**Note:**

Do not use OAAM Advanced or OAAM Basic.

---

---

To configure Access Manager for Integration with OAAM Integration

1. Protect a resource ([Defining Authentication Policies for Specific Resources](#)) using the TAPScheme for authentication ([Table 22-21](#)).
2. Add the following challenge parameter to the TAPScheme ([Table 22-22](#)):

```
TAPOverrideResource=http://IAMSuiteAgent:80/oaamTAPAuthenticate
```

### 55.5.3.3 Validating Identity Context Data Published by OAAM

You might validate Identity Context data published by OAAM.

To validate:

- `oracle:ldm:claims:risk:newdevice` will be *true* after a login from a new device; *false* otherwise.

- `oracle:ldm:claims:risk:level` will have a high value after a couple of unsuccessful logins followed by a successful login. To test for this, try a few unsuccessful logins and then a successful one.
- `oracle:ldm:claims:risk:safeuser` will have `true` after a user successfully answers the challenge question.
- `oracle:ldm:claims:risk:fingerprint` contains the user's device's fingerprint. By default, the fingerprint built out of HTTP header data is used; if that is not available, fingerprint data built out of Flash will be used. To test for different fingerprints, try different devices.

### 55.5.4 Configuring Web Service Security Manager

You can enable Oracle Web Service Security Manager (OWSSM) to propagate Identity Context.

To configure Web Service Security Manager for Identity Context:

1. Configure Security Policy by modifying the Identity Context supported OWSSM security policies to contain the `propagate.identity.context` element with a value of `true`.

---



---

**Note:**

`propagate.identity.context` (by default, `false`) is a configuration override property on SAML related policies. To enable it globally, configure a global policy with the property set to `true`.

---



---

2. Configure the Keystore and Credential Store to sign the SAML assertion and messages: copy the updated Keystore and Credential Store to your `$DOMAIN_HOME/config/fmwconfig/` directory.

### 55.5.5 Configuring Oracle Entitlements Server

Runtime integration with Oracle Entitlements Server (OES) is fully automated.

When an application invokes the PEP API to make an authorization call, the PEP API automatically propagates the entire Identity Context Runtime to the OES PDP where Conditions (the policy objects that define the Identity Context) are evaluated.

---



---

**Note:**

When making authorization calls, ensure that the last argument passed into the `newPepRequest()` method is not null, and is at least an empty hashmap as shown in this example:

```
PepRequestFactory requestFactory =
 PepRequestFactoryImpl.getPepRequestFactory();
PepRequest request = requestFactory.newPepRequest (subject,
 action, resource, new HashMap<String, Object>());
PepResponse response = request.decide();
boolean isAuthorized = response.allowed();
```

---



---

Conditions are built, based on the Identity Context schema, by a security Administrator using the OES Administration Console. The following built-in functions are used to specify Conditions using Identity Context attributes:

- ASSERT\_IDENTITY\_CONTEXT
- GET\_STRING\_IDENTITY\_CONTEXT
- GET\_INTEGER\_IDENTITY\_CONTEXT
- GET\_BOOLEAN\_IDENTITY\_CONTEXT

Custom OES functions receive the full Identity Context Runtime information as a well-known request attribute. This data structure can be converted into Identity Context Runtime using the Identity Context API. The following example shows a custom OES function creating a context from the received parameter.

Custom Function Creating Identity Context:

```
public OpssString GET_STRING_IDENTITY_CONTEXT_V2 (
 RequestHandle requestHandle,
 Object[] args,
 Subject subject,
 Map roles,
 Resource resource,
 ContextHandler contextHandler) throws RuntimeException {

 // Obtain string representation of the runtime ID Context from the request handle.
 Context runtimeCtx = null;
 try {
 AttributeElement ctxAttr = requestHandle.getAttribute
 (Constants.IDM_IDC_API_ID, false);
 if (ctxAttr != null) {
 String ctxStr = (String) ctxAttr.getValue();
 runtimeCtx = new Context(ctxStr);
 } else {
 throw new RuntimeException ("Unable to acquire ID Context from request
handle");
 }
 } catch (Exception e) {
 throw new RuntimeException (e.toString());
 }

 ...

 // start using Context which now contains the same exact Identity Context Runtime as
 was present in the application that made the PEP API call
 ...
}
```

### 55.5.6 Configuring Oracle Enterprise Single Sign On

As part of the Identity Context Service, Oracle Enterprise Single Sign-on (OESSO) can publish and propagate client-based Identity Context attributes.

Once full integration has been configured, client-specific Identity Context attributes (as documented in [Identity Context Dictionary](#)) will be sent by OESSO to OAM in the session initiation request together with the user credentials submitted in the access request.

After the request has been received, OESSO makes a call to an SSL-protected OAM REST API (previously configured by the OESSO Administrator and included as part of the OESSO client distribution). This API returns the OAM\_ID cookie to OESSO. OESSO then propagates the valid OAM\_ID cookie to the client browsers (Internet Explorer and Firefox) which enables OESSO resources to be protected and enables single sign-on (SSO) with those resources that are protected by the OAM Embedded Credential Collector. (This does not include resources that are protected by the Distributed Credential Collector.) OESSO then provides OAM credentials that are acceptable to the OAM Embedded Credential Collector as well as client context information in the payload.

---

---

**Note:**

The payload is secured by:

- Generating a 16 byte Random Salt
  - Generating a SHA-256 Hash using the 16 Byte Random Salt
  - Encrypting the claims using the OAM password protected by OESSO
- 
- 

To configure OESSO to get attributes for Identity Context

1. Refer to "Installing Logon Manager Client-Side Software" in the for details on integrating OAM and OESSO.
2. See additional details in the section "Oracle Access Management Support in Logon Manager".

## 55.5.7 Configuring Oracle Access Management Mobile and Social

Oracle Access Management Mobile and Social (Mobile and Social) provides REST-based authentication services, in addition to a user profile service and an authorization service, for mobile and desktop devices. When Mobile and Social is configured to provide authentication using Access Manager, it can publish Identity Context attributes provided by the mobile client to Access Manager. The Identity Context attributes are published by the Mobile and Social SDK for iOS and Java platforms.

Mobile applications use the Mobile and Social SDK to access and use services provided by the Mobile and Social server. When a mobile application uses the iOS or Android API to perform authentication, it captures the Identity Context attributes and publishes the data to the Mobile and Social server which, in turn, publishes the attributes to the Access Manager server. The Administrator can configure the Mobile and Social server to get all the attributes or only the required ones.

The Administrator configures the Identity Context attributes to be sent by the application in the Application Profile configuration page of the Mobile and Social accordion under the System Configuration tab in the Access Manager Administration Console.

The Mobile and Social server passes the required Identity Context attributes to the Mobile and Social SDK when it contacts the server for the application profile. (An application profile has information regarding the type of authentication to be performed as well as the Identity Context attributes to be collected.) The SDK collects the attributes, if allowed by the user or the platform, and publishes them to the Mobile and Social server as part of the authentication request.

**Note:**

Some mobile platforms (iOS, for example) forbid applications from collecting certain device attributes (for example, the UDID or IMEI device number). The user can also deny an application from getting a location update. Thus, even if the server requests attributes, it is not guaranteed that all of them can be collected by the SDK.

To configure the Mobile and Social server to publish the attributes collected from the Mobile and Social SDK to the user session created on and maintained by the OAM Server, the administrator must configure Mobile and Social server to enable ID Context, as illustrated in [Figure 55-4](#).

**Figure 55-4 OAM Authentication Provider Configuration**

**Service Provider Configuration** Save Revert

\*Required

---

Name: MobileOAMAuthentication

Description: Out Of The Box Mobile Oracle Access Manager (OAM) Authentication Service Provider

Service Provider Java Class: oracle.security.idaas.rest.provider.token.MobileOAMTokenServiceProvider

**Attributes**

Attributes View + Add × Delete

Name	Value
OAM_VERSION	OAM_11G
DEBUG_VALUE	0
TRANSPORT_SECURITY	OPEN
OAM_SERVER_1	slc01mqd.us.oracle.com:5575
OAM_SERVER_1_MAX_CONN	4
OAM_SERVER_2	slc01mqd.us.oracle.com:5575
OAM_SERVER_2_MAX_CONN	4
colocated.oam	true

**WebGate Agent**

\* WebGate ID: accessgate-oic

Encrypted Password: ••••• Show in clear text

To configure Mobile and Social to get attributes for Identity Context

1. Confirm that the Mobile and Social Service is enabled as described in "[Available Services of the Common Configuration Section](#)".
2. On the MobileOAMAuthentication Service Provider page, add the IDContextEnabled Attribute with the value of true.

---

---

**See Also:**

- [Configuring Mobile and Social Services](#) for full configuration details
  - *Oracle Fusion Middleware Developer's Guide for Oracle Access Management* for details on how to develop applications using the iOS SDK
- 
- 

## 55.6 Validating Identity Context

You can ensure correct operation of the Identity Context with Access Manager.

To validate:

To validate your Identity Context operations

1. Perform the following to validate the Identity Assertion response that Access Manager is constructing.
  - a. Configure Access Manager to protect the `/testidc` resource with a WebGate agent and return the Identity Assertion with the desired Asserted Attributes as part of the Authorization response.
  - b. Use the OAM Tester to validate that the Identity Assertion is returned as an `OAM_IDENTITY_ASSERTION` attribute in response to the authorization request for `/testidc`.
2. Perform the following to validate that WebGate is creating an HTTP header that contains the Identity Assertion.
  - a. Ensure the `/cgi-bin/printenv.pl` script is protected by the same policy that protects the `/testidc` resource.

---

---

**Note:**

`printenv.pl` ships as part of OHS and must have permission to execute. Any script to display header information can be used instead.

---

---

- b. Access the `printenv.pl` to trigger a login and display the HTTP headers.
- c. Ensure that the `HTTP_OAM_IDENTITY_ASSERTION` header contains a SAML token with Asserted Attributes.





# Part XV

---

## Integrating Access Manager with Other Products

Administrators integrate Access Manager with products from other vendors.

This section contains the following chapters:

- [Integrating RSA SecurID Authentication with Access Manager](#)
- [Configuring Access Manager for Windows Native Authentication](#)
- [Integrating JBoss with Access Manager](#)
- [Integrating Microsoft SharePoint Server with Access Manager](#)
- [Integrating Access Manager with Outlook Web Application](#)
- [Integrating Microsoft Forefront Threat Management Gateway 2010 with Access Manager](#)
- [Integrating Access Manager with SAP NetWeaver Enterprise Portal](#)
- [Integrating Oracle Access Manager with SAP NetWeaver Enterprise Portal Using OpenSSO Policy Agent 2.2](#)



---

# Integrating RSA SecurID Authentication with Access Manager

Oracle provides components that interface with RSA Security products to provide native RSA SecurID® authentication for Access Manager protected resources.

This chapter introduces SecurID authentication and the components, requirements, and processes needed to successfully integrate SecurID authentication with Access Manager 11.1.2. The following topics are included:

- [Introduction to Access Manager and RSA SecurID Authentication](#)
- [Components Required for SecurID Authentication](#)
- [SecurID Authentication Modes](#)
- [Configuring Access Manager for RSA SecurID Authentication](#)
- [Running a Custom RSA Plug-in](#)

## 56.1 Introduction to Access Manager and RSA SecurID Authentication

Access Manager 11.1.2 integrates with RSA components to provide SecurID authentication.

RSA SecurID authentication is based on two factors: something the user knows and something the user has:

- **Something the User Knows:** This is a secret personal identification number (PIN), similar in concept to a personal bank code PIN. In this case, the PIN may be system generated or personally chosen and registered with the RSA Authentication Manager.
- **Something the User Has:** This is the current code generated by a hand held device known as a token. Oracle Access Manager supports all RSA SecurID token form factors, both hardware and software-based.

These tokens algorithmically, based on an internal clock or event, generate tokencodes with unpredictable values. Together, the user's PIN and the SecurID tokencode become the user's Passcode.

Access Manager uses and supports RSA two-factor SecurID authentication security features and enables integration with SecurID authentication by providing:

- The HTML forms required for SecurID authentication operations
- The RSA SecurID Plugin you can use with the User Identification Plugin to create and orchestrate authentication

## 56.2 RSA Features Supported by Access Manager

Access Manager integrates with RSA Authentication Manager and provides the integration features described in [Table 56-1](#).

**Table 56-1 Access Manager Support for RSA Features**

RSA Feature	Access Manager Support
Authentication method	Native SecurID authentication
New PIN Mode (user-generated PINs)	<p>Asks for new PIN with confirmation.</p> <p>The token may be in New PIN mode the first time the user logs in or the Authentication Manager Administrator can enable New PIN mode. New PIN mode requires the user to complete a sequence of forms to define, or have the system generate, a new PIN number.</p> <p>Oracle-Provided New PIN Forms and Functions:</p> <ul style="list-style-type: none"> <li>• System Generated PIN (not supported)</li> <li>• User Defined (4-8 Alpha/numeric characters)</li> <li>• User Defined (5-7 Numeric)</li> <li>• Deny 4 and 8 Digit PIN</li> <li>• Deny Alphanumeric PIN</li> <li>• Deny Numeric PIN</li> <li>• PIN Reuse</li> </ul> <p>See Also: "<a href="#">SecurID New PIN Authentication</a>".</p>
Next Tokencode	<p>During authentication, the Authentication Manager may direct the user to provide the next tokencode that appears on their SecurID token to prove that they have the assigned token. This operation is known as Next Tokencode mode, which can be triggered by one of the following situations:</p> <p>See Also: "<a href="#">SecurID Next Tokencode Authentication</a>".</p>
Passcode	<ul style="list-style-type: none"> <li>• 16 Digit Passcode</li> <li>• 4 Digit Fixed Passcode</li> </ul>
Load Balancing	RSA Authentication Manager Replicas.
Secondary server support	Yes
SecurID user specification	Designated users
SecurID protection of Administrators	Yes
Access Manager features and functions	All

Access Manager does not support the RSA features in [Table 56-2](#).

**Table 56-2 RSA Features Not Supported**

<b>RSA Feature</b>	<b>Not supported by Access Manager</b>
RSA Authentication Manager 7.1 SP2	Is not supported in an Active Directory Forest multi-domain environment
Multiple ACE Realms	The RSA Authentication API uses an automatic response time load balancing algorithm to determine where to send an authentication request. Such requests go to either a primary RSA Authentication Manager or a replica. The automatic algorithm can be overridden by creating a manual load balancing configuration file, <code>sdopts.rec</code> . However manually weighting an RSA Authentication Manager as a server of last resort does not preclude the Agent from communicating with it. As such, a true failover setup cannot be achieved with this method. For more information, see your RSA Authentication Manager documentation
System Generated PINs	Not supported by Access Manager.
Failover	Not supported for OAM SecurID Servers because only one OAM SecurID Server can perform SecurID authentication.

## 56.3 Components Required for SecurID Authentication

The following components are needed for the integration:

- [Supported Versions and Platforms](#)
- [Required RSA Components](#)
- [Installation and Configuration Requirements](#)

### 56.3.1 Supported Versions and Platforms

For the latest support information, see the Oracle Technology Network (OTN). You must register with OTN to view this information.

The certification matrix provides platform and version support for this integration, which includes RSA Authentication Manager v7.x and the SecurID Authentication API:

<http://www.oracle.com/technetwork/middleware/ias/downloads/fusion-certification-100350.html>

### 56.3.2 Required RSA Components

The following RSA components are required for integrating Access Manager and SecurID Authentication.

- [RSA Authentication Manager](#)
- [RSA SecurID Tokens](#)

### 56.3.2.1 RSA Authentication Manager

Residing somewhere in your network are records of users, agents, tokens, and user's PINs. Portions of these records might reside in the Authentication Manager or in LDAP directories.

During authentication, Authentication Manager compares these records to the information it receives when a user attempts to access the network. If the records and tokencode or passcode match, the user is granted access.

### 56.3.2.2 RSA SecurID Tokens

An RSA SecurID token is either a hardware device or software-based security token that generates and displays a random number that enables users to securely access protected resources.

The random number is called a tokencode. Before a user can authenticate with a token, the token must be recognized by Authentication Manager. RSA, or your vendor, ships a token seed file that you must import into the data store. Seeds listed in this file are assigned to tokens for generating the tokencode when an authentication request is received from an Authentication Manager agent.

During the SecurID authentication process, users must submit their username and passcode using an HTML form. The RSA Authentication Manager authenticates the identity of each user through a server that is registered with the Authentication Manager as a client (RSA Authentication Agent). One Access Server (known as the Oracle SecurID Access Server to distinguish it from other Access Servers) must be registered and set up as a client/Agent.

The RSA Authentication Manager compares the tokencode it has generated with the tokencode the user has entered. Tokencodes change at a specified interval, typically 60 seconds. Time synchronization ensures that the tokencode displayed on a user's token is the same code the Authentication Manager software has generated for that moment. Authentication is successful when the tokencodes match. Two-factor authentication provides stronger legal evidence of who performed the task. When properly configured, the Authentication Manager tracks all login requests and operations to reliably identify the user who is responsible for each logged action.

## 56.3.3 Installation and Configuration Requirements

SecurID requires affinity between the OAM Server and the RSA Authentication Manager for a user interaction. Therefore, the authentication dialog between the user and OAM Server must be sticky (this constraint is a security feature of SecurID authentication). In a cluster environment, if a load balancer is used to route requests to multiple managed server, ensure that stickiness is set between the load balancer and OAM Server. The SecurID Authentication API is bundled with Access Manager and installed on all OAM Servers. The SecurID Authentication API provides the connection functionality that eliminates the need for an Authentication Agent to be installed on the OAM Server. In other words, the API is the agent.

Every OAM Server must be registered as an RSA Authentication Agent host on the Authentication Manager along with the guidelines as follows:

- Only one designated OAM SecurID Server can complete SecurID authentication. However, every OAM Server must be registered as an RSA Authentication Agent Host on the Authentication Manager.

- Enable the OAM SecurID Server to be recognized as an Authentication Manager client.
- Port 5500 (UDP) should be available for the Authentication Manager to communicate with authentication agents (OAM SecurID Server). This service receives authentication requests from Oracle SecurID Server and sends replies. For more details refer to your RSA Authentication Manager documentation.
- Manage authentication requests from the client to the Authentication Manager.
- Enforce two-factor authentication and block unauthorized access.
- Provide automatic load balancing by detecting replica Authentication Manager response times and routing authentication requests accordingly.
- Ensure that the system time on the client is correct to prevent the server and client from being out of sync.
- Failover is not supported for Access Manager.
- The SecurID Authentication Manager must be installed on a supported platform.
- The system time must be correct to prevent the server and client from being out of sync.
- The SecurID tokens or key fobs must be provisioned with the Authentication Manager by providing it with the token seed records.
- Each user name must be mappable through an LDAP filter to a Distinguished Name in the directory.
- An Authentication Manager slave and/or replicated Authentication Manager can provide failover if the primary Authentication Manager is down.
- This integration requires a custom HTML login form and a properties file. Sample Oracle-provided custom html and custom html properties files can be found in:  
`$ORACLE_HOME/oam/server/tools/customLoginHtml`

See Also:

- *Developing Custom Login Pages in the Oracle Fusion Middleware Developer's Guide for Oracle Access Management*
- ["Configuring Access Manager for RSA SecurID Authentication"](#)

## 56.4 SecurID Authentication Modes

The following scenarios illustrate the three modes of operation:

- [Standard SecurID Authentication](#)
- [SecurID Next Tokencode Authentication](#)
- [SecurID New PIN Authentication](#)

### 56.4.1 Standard SecurID Authentication

Here is an overview of the process that occurs when a user attempts to access a resource protected by the SecurID authentication scheme.

For information on Credential Collectors, see [Understanding Credential Collection and Login](#).

Process overview: When the user requests a resource

1. The WebGate intercepts the resource request and queries the Access Server to determine if and how the resource is protected, and if the user is authenticated.
2. The OAM SecurId Server queries the directory for the authentication scheme, and receives authentication information from the directory.
3. The WebGate redirects to the Credential Collector, which presents a form challenging the user for a two-part SecurID Passcode.
4. The user submits credentials to the Credential Collector
5. The Credential Collector hands off the credentials to the OAM SecurId Server
6. The SecurID Authentication API on the OAM SecurId Server performs the authentication dialog and sends an LDAP bind to the Authentication Manager.
7. The Authentication Manager database matches the SecurID passcode to the user ID and returns a success response to the Authentication Manager, which matches the user's PIN.
8. The Authentication Manager returns the response to its Agent, the OAM SecurId Server.
9. When the user's credentials are valid, SecurID authentication is successful. The OAM SecurId Server creates a session for the user and redirects the user to the Webgate, which then queries the OAM SecurId Server for resource authorization:
  - Under certain conditions a New Tokencode mode is initiated, as described in "[Standard SecurID Authentication](#)".
  - Under certain conditions a New Pin mode is initiated, as described in "[SecurID Next Tokencode Authentication](#)".
10. The OAM SecurId Server evaluates the authorization request, which allows or denies access based upon the authorization rule.
11. When access is granted, the OAM SecurId Server passes authorization to the WebGate, which presents the resource to the user.

## 56.4.2 SecurID Next Tokencode Authentication

When Next Tokencode mode is On, the user must supply the next tokencode on their SecurID token.

This mode can be triggered when:

- An incorrect Passcode was provided repeatedly during login. When a user attempts authentication with incorrect passcodes four consecutive times, the Authentication Manager turns on Next Tokencode mode, as noted in the Authentication Manager's Activity Report. The next time the user successfully authenticates with their correct Passcode, they are challenged for the next tokencode that appears on their SecurID token.
- The Authentication Manager requires confirmation of, or synchronization with the token. Even with a correct Passcode, the Authentication Manager



Administrator might set the Next Tokencode mode On to force the user to confirm that they have the SecurID token or to synchronize the token with the Authentication Manager. When Next Tokencode mode is On, the Next Tokencode challenge form is presented to the user immediately following a successful login.

Process overview: When Next Tokencode is On

1. The Credential Collector presents a form to challenge the user for the next tokencode on the token following a successful login.
2. The user enters a username, waits 60 seconds, then enters the next tokencode on the SecurID token.
3. When the tokencode is correct, the Passcode the user originally entered is accepted and the user is authenticated.

### 56.4.3 SecurID New PIN Authentication

When the user is required to have a new PIN, the Credential Collector prompts the user with specific forms.

Process overview: When New PIN is required

1. The Credential Collector presents a form that allows the user to enter the PIN they want.
2. The user enters the new PIN and then re-enters the new PIN to complete the form.
3. The OAM SecurID Server forwards the information to the Authentication Manager.
4. The Authentication Manager registers the new PIN, which becomes part of the Pincode the user must supply during subsequent logins.
5. The Login Form appears again where the user enters the username and Passcode for a forced re-authentication.

## 56.5 Configuring Access Manager for RSA SecurID Authentication

Users with valid Oracle Access Management Administrator credentials can enable RSA SecurID authentication.

Prerequisites

See [Installation and Configuration Requirements](#) for installation and configuration (that is outside the scope of this manual) and which must be completed before you begin SecurID integration with Access Manager.

---

---

**See Also:**

- *Developing Custom Pages in Oracle Fusion Middleware Developer's Guide for Oracle Access Management*
- 
- 

To set up SecurID Authentication with Access Manager

1. In your `oam-config.xml`, set the OAM SecurID Sever `serverRequestCacheType` parameter to BASIC, as follows:

- a. Stop all WebLogic servers (OAM Servers and AdminServer).
  - b. Locate oam-config.xml in the following path:  
`$DOMAIN_HOME/config/fmwconfig/oam-config.xml`
  - c. Change the `serverRequestCacheType` from `COOKIE` (default) to `BASIC`, as follows:  
`<Setting Name="serverRequestCacheType" Type="xsd:string">BASIC</Setting>`
  - d. Start all WebLogic Servers (OAM Servers and AdminServer).
2. Register a Web agent from the RSA Console that will be used by Access Manager, then copy the agent configuration file (`sdconf.rec`) as follows:  
`$DOMAIN_HOME/config/fmwconfig/servers/$SERVER_NAME/oam/sdconf.rec`
  3. Using the Oracle Access Management Console, create a custom authentication module for RSA, as follows:

---

---

**See Also:**

["Orchestrating Multi-Step Authentication with Plug-in Based Modules "](#)

---

---

- a. Click **Application Security** at the top of the window.
- b. Select **Create Custom Authentication Module** from the **Create (+)** drop-down menu in the **Plug-ins** section.
- c. Select the **General** tab and enter the following:  
`Name: RSA_AUTH`
- d. Select the **Steps** tab and enter a name for the Step, then choose the RSA SecurID Plugin  
`Step Name: stepRSA`  
`Plugin Name: RSA SecurID Plugin`  
`OK`
- e. In the **stepRSA, Step Details** tab, enter and **Save** the Step Details shown in the next screen, which should also appear in your `customhtml.properties` file:

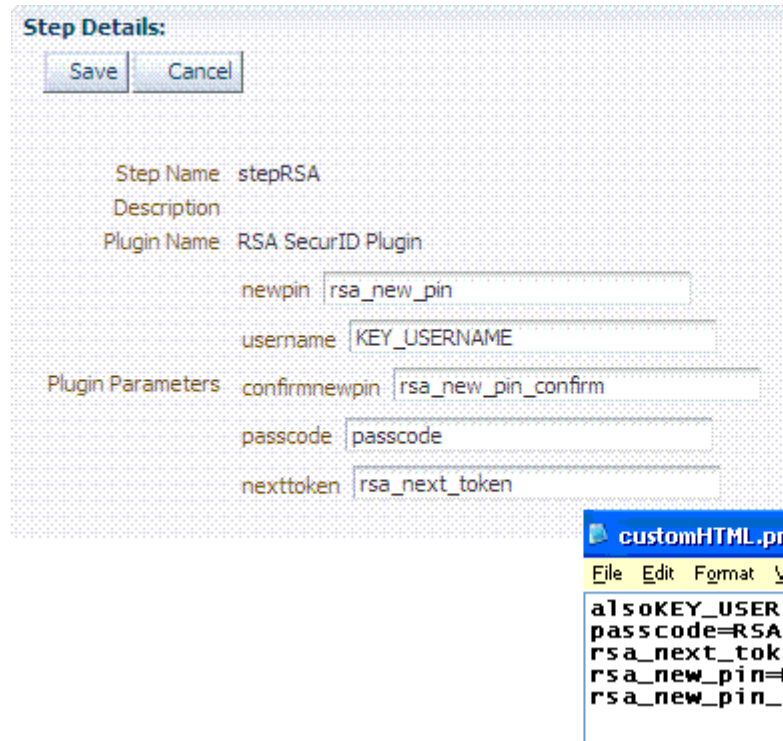

- f. Steps tab: Add the User Identification Plugin: Enter a name for the Step, then choose the RSA SecurID Plugin:
 

```
Step Name: rsa_useridentification
Plugin Name: UserIdentificationPlugin
OK
```
- g. rsa\_useridentification, Step Details: Enter and Save the following details for your environment:
 

```
KEY_LDAP_FILTER: (uid={KEY_USERNAME})
KEY_IDENTITY_STORE_REF: The registered Default Store.
KEY_SEARCH_BASE_URL: dc=us,dc=example,dc=com
```
4. Orchestrate the steps as follows: stepRSA should be first (to authenticate the user with the RSA Server); designate your User Identification Plugin for the success step.
 

```
Initial Step: stepRSA

Name: StepRSA
On Success: rsa_useridentification
On Failure: failure
On Error: failure
Apply

Name: rsa_useridentification
On Success: Success
On Failure: failure
On Error: failure
Apply
```

**Note:**

The On Failure and On Error fields must both be set to failure.

5. Create a new authentication scheme (*RSACredScheme*, for example) that uses the custom authentication module that you just created for RSA with a custom HTML login form. Sample values are shown in the following screen:

The screenshot shows the 'Authentication Schemes' configuration interface. The fields are as follows:

- Name:** RSACredScheme
- Description:** (empty)
- Authentication Level:** 2
- Default:** (unchecked)
- Challenge Method:** FORM
- Challenge Redirect URL:** /oam/server
- Authentication Module:** RSA\_AUTH
- Challenge URL:** /CustomReadServlet
- Context Type:** customHtml
- Context Value:** /example/sample/Oracle/Middlewa
- Challenge Parameters:** initial\_command=RSA\_USER\_PASSCODE; is\_rsa=true

**Note:**

The authentication scheme's Context Value specifies the path to your custom HTML login form. Your custom HTML properties file must share the same name as the form (with a `.properties` extension) in the same directory path. This example uses `customhtml.html` and `customhtml.properties`.

Challenge parameters specify the initial RSA command for authentication (`RSA_USER_PASSCODE`). The `is_rsa=true` parameter and value must be specified for RSA.

6. Use this scheme in the Application Domain protecting resources requiring SecurID authentication.
7. Ensure that your custom HTML file is present in:

`$DOMAIN_HOME/config/fmwconfig/customhtml.html`

The Custom HTML for RSA Login Form requires form action set to `/oam/server/auth_cred_submit`, as follows:

```
<form id="loginData" action="/oam/server/auth_cred_submit" method="post"
name="loginData">
```

```
<div id="oam_credentials" class="input-row">

</div>
```

```

div class="button-row">

<input id="login_button" type="submit" value="Login" class="formButton"
 onclick="this.disabled=true;document.body.style.cursor = 'wait';
 this.className='formButton-disabled';form.submit();return false;"/>

</div>
<div id="oam_error_messages"></div>
</form>

```

8. Ensure that your *customHTML.properties* file is:

- Named as your custom HTML file with a *.properties* extension
- Stored in the same path as your custom HTML file
- Confirmed; settings match the RSA SecurID plugin configuration parameters. For example:

```

username=Username
password=Password
passcode=Mother's maiden name
rsa_new_pin=RSA New Pin
rsa_new_pin_confirm=RSA Confirm New Pin
Pin=RSA Pin
rsa_sysgen_pin=RSA Create New Pin
rsa_sysgen_pin_confirm=RSA System Generated Pin
error1=Username not specified

```

9. Restart OAM Servers.

10. Test your configuration by accessing the appropriate protected resource and validating the various modes.

11. See "[RSA SecurID Issues and Logs](#)" for details if you experience problems.

## 56.6 Running a Custom RSA Plug-in

You can run a custom RSA plug-in located in `<ORACLE_HOME>/oam/custom_plugins/rsa/RSAPugin.jar`.

To run a custom RSA plug-in:

1. Download the RSA dependent libraries named `authapi.jar` and `cryptoj.jar`.
2. Add the `authapi.jar` and `cryptoj.jar` libraries to `<DOMAIN_HOME>/config/fmwconfig/oam/plugin-lib`.
3. Get the custom `RSAPugin.jar` file from its directory and import the plugin to add it to the list of custom plugins.
4. Once successfully imported, distribute and activate the plug-in.

Activation will fail the first time. When it does, restart the server and activate again. After activation, use the plugin to specify the necessary orchestration steps.



---

# Configuring Access Manager for Windows Native Authentication

Access Manager enables Microsoft Internet Explorer users to automatically authenticate to their Web-based single sign-on applications using their desktop credentials. This is known as Windows Native Authentication (WNA)

This chapter contains the following sections to describe how to prepare your environment and perform this integration using Active Directory:

- [Introducing Access Manager with Windows Native Authentication](#)
- [About Preparing Your Active Directory and Kerberos Topology](#)
- [Confirming Access Manager Operations](#)
- [Enabling the Browser to Return Kerberos Tokens](#)
- [Integrating KerberosPlugin with Oracle Virtual Directory](#)
- [Integrating the KerberosPlugin with Search Failover](#)
- [Configuring Access Manager for Windows Native Authentication](#)
- [Validating WNA with Access Manager Protected Resources](#)
- [Configuring WNA For Use With DCC](#)
- [Troubleshooting WNA Configuration](#)

## 57.1 Introducing Access Manager with Windows Native Authentication

Access Manager supports Active Directory Multi-Domain and Multi-Forest topology integration with Windows Native Authentication (WNA).

The Active Directory directory service uses a data store that is also known as the **directory** for information about objects, such as users, groups, computers, domains, organizational units, and security policies.

---

**See Also:**

The System Requirements and Supported Platforms for Oracle Identity and Access Management 11gR1 at <https://www.oracle.com/technetwork/middleware/ias/downloads/fusion-certification-100350.html>

---

For the integration, an application must be protected by an Access Manager authentication policy that uses the Kerberos authentication scheme (KerberosScheme) with WNA as the Challenge Method with the KerberosPlugin Authentication Module.

In this case, credentials must be stored in a Windows Active Directory instance that is registered as a user-identify store with Access Manager.

Each protected resource is defined in an Application Domain. The Authentication Policy includes the Authentication Scheme (KerberosScheme) that uses an Authentication Module (Kerberos) that is tied to the default User Identity Store. The store uses the value of "User Name Attribute" for authentication. This value is tied to the user in Active Directory and its values for `userprincipalname` = `username@domain` or `SamAccountName` = `username`, depending on the specific Access Manager release.

When Access Manager single sign-on is combined with WNA, a Kerberos session ticket is generated that contains the user's login credentials (among other things). This Kerberos session ticket is not visible to the user.

Access Manager interoperates with WNA, which uses Kerberos credentials obtained when the user logs in to a Windows Domain. This cross-platform authentication is achieved by emulating the negotiate behavior of native Windows-to-Windows authentication services that use the Kerberos protocol. For this cross-platform authentication to work, OAM Servers must parse SPNEGO tokens to extract the Kerberos tokens that are then used for authentication.

- **SPNEGO** is a Generic Security Services Application Programming Interface (GSSAPI) "pseudo mechanism" used to negotiate one of a number of possible real mechanisms. SPNEGO is largely employed in the Microsoft "HTTP Negotiate" authentication extension which uses it to allow initiators and acceptors to negotiate either Kerberos or NTLMSSP mechanisms. GSSAPI implementation is included with most major Kerberos distributions.

See <http://tools.ietf.org/html/rfc4559> for more information on SPNEGO.

- **Kerberos** is a network authentication protocol that provides strong authentication for client/server applications and services using a secret-key cryptography. A free implementation of Kerberos protocol is available from the Massachusetts Institute of Technology and is also commercially available.

See:

- [Understanding Access Manager WNA Login and Fall Back Authentication](#)
- [Supported Kerberos Authentication Modules](#)

### 57.1.1 Understanding Access Manager WNA Login and Fall Back Authentication

With WNA implemented, a user can open a Web application without another challenge for credentials because the Kerberos session ticket is passed through the browser to the OAM Server.

The OAM Server decrypts the received token (using keytab) and derives the authenticated user name from it. If authentication succeeds the user is granted access to the Web application automatically.



---

---

**See Also:**

Supported browsers in the System Requirements and Supported Platforms for Oracle Identity and Access Management 11gR1 at <https://www.oracle.com/technetwork/middleware/ias/downloads/fusion-certification-100350.html>

---

---

The following sections describe an overview of the process of two WNA login scenarios.

- [Successful Access Manager WNA Authentication](#)
- [Access Manager WNA Fallback Authentication](#)

#### 57.1.1.1 Successful Access Manager WNA Authentication

1. The Browser is configured for Integrated Windows Authentication (IWA).  
This is a browser security configuration. If the browser being used is not configured to use IWA, no TGT is supplied when a resource protected by the Kerberos authentication module is requested. A browser basic authentication window is displayed where you can enter a valid username/password combination defined in the Default Identity Store for `User login attribute`.
2. A resource protected by Access Manager and WNA is called.  
The protected resource should be configured as an intranet resource. This is done by adding the site in the "Local Intranet" zone of the Browser configuration.
3. A valid Kerberos ticket is present - `Http headers... Authorization: Negotiate YIIJ/...`
4. The user is not challenged for authentication. The requested resource is displayed, proving that WNA works.

In other words, when the browser is configured to use Integrated Windows Authentication, and a resource is protected by the Kerberos authentication module, then:

- If a Kerberos ticket is received by Access Manager (regardless of the domain), authentication is attempted:
  - Successful: Access is granted.
  - Failure: An incorrect user name or password error occurs if information from the Kerberos ticket is either not present or does not match the value of the User Name Attribute defined in the Default User Identity Store. Access is denied. The browser automatically submits the ticket, and the interaction with Access Manager is repeated until the user has been locked out. The browser cannot be made to pause before the start of each exchange.
- If the user is not logged on to a Windows Domain by way of Kerberos authentication, the browser sends OAM an NTLM token for authentication instead of a Kerberos token. Depending on how Access Manager is configured, it either uses WNA Fallback Authentication upon receiving an NTLM token or authentication fails.

---

---

**Note:**

You need to configure Access Manager to provide fallback authentication when the browser sends an NTLM token. Without configuration, authentication fails. For configuration steps, see [Configuring WNA for NTLM Fallback](#).

---

---

NTLMSSP is a security support provider that is available on all versions of the Distributed Component Object Model (DCOM). It uses the NTLM protocol for authentication, which does not actually transmit the user's password to the server during authentication.

---

---

**Note:**

If a Kerberos ticket cannot be identified by Access Manager (regardless of browser, Operating System, domain-login, and so on), the fallback mechanism is invoked.

---

---

### 57.1.1.2 Access Manager WNA Fallback Authentication

Fallback uses the authentication scheme "BasicScheme" with a challenge method of "Basic" and authentication module "LDAP".

This LDAP Authentication Module uses the LDAP plug-in. In this plug-in, the User Identity Store can be defined as any currently registered User Identity Store in which you define the attribute to be used for "User Name Attribute." The authentication module can be changed using the console.

1. The Browser is configured for Integrated Windows Authentication (IWA).

This is a browser security configuration. Access Manager handles two types of WNA fallback authentication.

- **Within Domain where IWA is enabled:** OAM supports WNA for the SPNEGO token. But sometimes due to configuration or other issues, OAM receives NTLM tokens from the client rather than SPNEGO. During the DEFAULT flow, OAM will try to authenticate using the NTLM token and fail because OAM doesn't have the capability to authenticate NTLM tokens. Thus, with introduction of "HandleNTLMResponse" configuration, OAM server will challenge client with Basic prompt for authentication. i.e. The fallback here is to prompt for basic mode of authentication if client is sending NTLM tokens to OAM Server. See [Configuring WNA for NTLM Fallback](#) for details.
- **Outside Domain where IWA is disabled:** Here no extra configuration is needed. By default the OOTB user will see a BASIC prompt during authentication.

2. A resource protected by Access Manager and WNA is called.

The protected resource should be configured as an intranet resource. This is done by adding the site in the "Local Intranet" zone of the Browser configuration.

3. No ticket is present (NTLM/Kerberos) - Http headers... Authorization: Basic
4. A basic authentication window pops up.

5. The user enters a valid username/password.
6. The requested resource is displayed (WNA Fallback works).

### 57.1.2 Supported Kerberos Authentication Modules

Use the Kerberos Authentication Module or KerberosPlugin Authentication Module when configuring Access Manager for Windows Native Authentication. The Kerberos Authentication Module identifies the key tab file and krb5 configuration file names and Principal.

The KerberosPlugin Authentication Module relies on bundled plug-ins (or those that are developed using the Access Manager Authentication Extensibility Java API). This module uses more than one plug-in that you can orchestrate to ensure that each one performs a specific authentication function. The KerberosPlugin Authentication Module is more robust and richer in functionality than the Kerberos Authentication Module. The KerberosPlugin Authentication Module (along with a plain WNA configuration) supports the following approaches:

- **Kerberos Plugin with Oracle Virtual Directory:** Using Access Manager with orchestrated authentication plug-ins integrated with Oracle Virtual Directory virtualize multiple Active Directory Global Catalogs.
- **Kerberos Plugin with Search Failover Across Multiple ADGCs:** Using Access Manager with orchestrated authentication plug-ins that exercise a failover pattern across multiple Active Directory Global Catalogs.

---

---

**See Also:**

- [About Preparing Your Active Directory and Kerberos Topology](#)
  - [Confirming Access Manager Operations](#)
  - [Integrating KerberosPlugin with Oracle Virtual Directory](#)
- 
- 

## 57.2 About Preparing Your Active Directory and Kerberos Topology

You need a fully-configured Microsoft Active Directory authentication service set up. Your Active Directory and Kerberos client will operate together.

The tasks in this section are required regardless of the approach you choose. However, none of this is Oracle specific.

---

---

**Note:**

The following sample scenario represents a typical Active Directory topology, and is not a requirement dictated by or for Access Manager. The naming used here is an example only. Your environment will be different.

---

---

As a sample scenario, consider two Active Directory forests operating within a company.

Forest	Domain Name
ORACLE	lm.example.com
SPRITE	lmsib.sprite.com

Consider that a child domain exists within the ORACLE forest:  
child.lm.example.com.

Trust is required as follows:

- Between forests: Two-way, non-transitive trust.
- Between the child domain and its parent: Two-way, transitive trust.

The suffixes and inheritance are:

- SPRITE users have UPN suffixes such as sun.com or java.com. The SPRITE forest contains testuser.java.com.
- ORACLE users have suffixes such as myoracleco.com and oracleco.com. The ORACLE forest contains testuser.oracleco.com.
- ORACLE child domain inherits the UPN suffixes of the parent domain.

---

---

**Note:**

Pre-Windows user names formed as DOMAIN\USERNAME, are not supported.

---

---

For integration with WNA, the `User Name Attribute` defined for the Default Identity Store can be any attribute whose value matches the Active Directory user's `samAccountName`.

You also need to know which encryption type your environment will use. In some cases a user might be created with "Use DES encryption types for this account" enabled. However, Active Directory is not using DES encryption.

---

---

**Note:**

The keytab file created in the following procedure uses RC4-HMAC encryption.

---

---

Access Manager supports what JGSS/JDK6 supports. The limitation on the TGT encryption that can be used would be determined by the piece that is the least common or lowest encryption supported: KDC, Keytab, Operating System, Kerberos client. Access Manager does not support any specific Kerberos encryption type. It is dependent on the Generic Security Services (GSS)/Kerberos jdk encryption types with which it is certified. Access Manager is not dependent on any encryption type and does not use TGT encryption. As part of SPNEGO token Access Manager only looks into the Service Ticket which is encrypted with a key that the service (in this case Access Manager) has registered when executing the `ktpass/keytab` commands.

**Note:**

The keytab file created in the following procedure uses RC4-HMAC encryption.

Encryptions are used for communication among the different OS (Windows/Linux acting as Kerberos Server/Client). OAM Server just needs the SPNEGO token, from which it extracts the user credential. The encryption used in this three way negotiation process between the Windows Client (Browser), the Windows KDC, and the Generic Security Services (GSS) classes used by Access Manager, depend on the versions used (which must match).

**See Also:**

My Oracle Support for details about the Kerberos Encryption types Access Manager Supports [Doc 1212906.1] at: <https://support.oracle.com/CSP/main/article?cmd=show&type=NOT&id=1212906.1>

In the trusted domain (for example, the root domain `lm.example.com`), it is required that you follow the steps provided to:

- Create an account for the OAM Server.
- Extract the keytab file that was configured with the Active Directory Multi-Domain or Multi-Forest topology and trust relationships.
- Specify the Service Principal Name (SPN) using the fully-qualified hostname of the OAM Server (or the load balancer that represents the OAM Cluster), followed by the Realm name.

For this example the names in [Table 57-1](#) are used.

**Table 57-1 Sample Naming**

Name	Description
<code>kdc.lm.example.com</code>	KDC <i>hostname</i> KDC is a trusted network service that supplies session tickets and temporary session keys to users and computers within an Active Directory domain. The KDC runs on each domain controller as part of Active Directory Domain Services and is implemented as a domain service. The KDC uses Active Directory as its account database. In implementations of the Kerberos protocol, the KDC is a single process that provides two services: Authentication Service (AS) and Ticket Granting Service (TGS).
<code>kdc.lm.example.com</code>	AdminServer <i>hostname</i> This is the same as the KDC <i>hostname</i> .
<code>oam11g.example.com</code>	OAM Server <i>hostname</i>

**Table 57-1 (Cont.) Sample Naming**

Name	Description
LM.EXAMPLE.COM	Default Active Directory Realm
LMSIB.SPRITE.COM	Second Active Directory Realm The realm name identifies the location of the user account. A realm name can be either a prefix or a suffix. When an access client sends user credentials, a user name is often included. Within the user name are two elements: a user account name and user account location.
HTTP/ <i>fully_qualified_OAMServer hostname@REALM_NAME</i> (in CAPITAL letters)	Service Principal Names (SPNs) are needed for user accounts (the name by which a client uniquely identifies an instance of a service). <b>Note:</b> If you install multiple instances of a service on computers throughout a forest, each instance must have its own Service Principal Name.

## 57.2.1 Preparing Active Directory and Kerberos

You can prepare Active Directory and Kerberos.

Commands are for a Unix Operating System. Command syntax will vary depending on the specific Operating System in your environment.

1. Check the Oracle certification matrix to ensure you are installing a supported version of Active Directory for this integration:  
<https://www.oracle.com/technetwork/middleware/ias/downloads/fusion-certification-100350.html>
2. Install and configure Active Directory as follows:
  - Multi-Forest topology with requisite trust relationships configured and functional, including:
    - a. User accounts to map Kerberos services
    - b. Service Principal Names (SPNs) for these user accounts (the name by which a client uniquely identifies an instance of a service).
    - c. Key tab files
  - Active Directory Global Catalog (ADGC) enabled and functional within each forest
  - **Multi-Forest Deployment:** In this case, ensure there exists a naming attribute (available in global catalog) that uniquely identifies the users originating from various forests. Generally, `userprincipalname` is unique for the forest and `samAccountName` is unique for the domain
  - One domain that is directly or indirectly trusted by every other domain, regardless of forest affiliation.
3. Create a user for Access Manager use during WNA authentication and record this user name for generating the keytab file (no DES encryption).
4. Record the OAM Server *hostname*. For example:

*oam11g.example.com*

5. Record the KDC *hostname* and the Active Directory domain/*realm*:

```
KDC = kdc.lm.example.com
Default AD Realm = lm.example.com
```

6. Create the Service Principal Name (SPN) of the Active Directory user that the OAM Server client is using, and record the results (including encryption type).

The user name should be in the format *user\_name@example.com* where *example.com* is the domain name of the Active Directory. For example:

```
ktpass -princ <protocol/oamserver_host> -pass <mypassword> -mapuser <user from
step 3> -out <path_to_filename>
```

---



---

**Note:**

Ensure that the case of the user name is consistent when entering it with the `ktpass`, `kinit` and `klist` commands. If you enter the user name in lower case when running one command, it must be entered in lower case when running the other commands.

For example, the case used in the commands to create the keytabs and the configuration in `/etc/krb5.conf` file need to match. When `ktpass` is run to create the keytab (as below), the host name of the KDC server is `lm.example.com`. Since this is all lower case, the configuration in the `/etc/krb5.conf` file must also be lower case. Case sensitivity is not the issue as long as the case matches.

---



---

```
ktpass -princ HTTP/oam11g.example.com@lm.example.com -mapuser oam -pass
examplepw -out c:\temp\oam.keytab
```

```
C:\Users\Administrator>ktpass -princ HTTP/oam11g.example.com@LM.EXAMPLE.COM
-mapuser oam -pass welcome1 -out c:\temp\oam.keytab
Targeting domain controller: kdc.lm.example.com
Using legacy password setting method
Successfully mapped HTTP/oam11g.example.com to oam.
WARNING: pType and account type do not match. This might cause problems.
Key created.
Output keytab to c:\temp\oam.keytab:
Keytab version: 0x502
keysize 80 HTTP/oam11g.example.com@lm.example.com ptype 0 (KRB5_NT_
UNKNOWN) vno 3 etype 0x17 (RC4-HMAC) keylength 16 (0xa3a685f89364d4a
5182b028fbe79ac38)
```

---



---

**Note:**

If the user is not part of the Administrators group, follow this procedure to explicitly allow a remote desktop connection for the user.

- a. From the Oracle Access Management Console, navigate to the Remote tab through Control Panel -> Remote Settings -> System Properties.
  - b. Select the "allow connections from computers running any version of Remote Desktop" option.
  - c. Click Select Users.
  - d. Add the user.
  - e. Click Apply.
- 
- 

7. Copy the newly created keytab file to the proper location on the OAM Server and ensure permissions are correct so that the user who created Access Manager can access this file for running `ktpass` command.
8. Create a simple OAM Server Kerberos `krb5.conf` or `krb5.ini` configuration. For example:

```
[libdefaults]
default_realm = lm.example.com
ticket_lifetime = 600
clock_skew = 600

[realms]
lm.example.com = { --
kdc = kdc.lm.example.com
admin_server = kdc.lm.example.com
default_domain = lm.example.com
}
[domain_realm]
lm.example.com =LM.EXAMPLE.COM
.lm.example.com = LM.EXAMPLE.COM
```

---



---

**Note:**

The OAM account is created in one domain that is trusted by all, `lm.example.com`. This is not required for `lmsib.sprite.com`.

---



---

9. Verify the `klist` and `kinit`s work using the keytab file and SPN of the Active Directory and Access Manager user created, then record the results.
  - a. `kdestroy`
  - b. `klist [-k] [-t <keytab_filename>]`. For example:

```
bash-3.2$ klist -k -t -K -e FILE:/refresh/home/oam.keytab
Keytab name: FILE:/refresh/home/oam.keytab
KVNO Timestamp Principal

3 12/31/69 19:00:00 HTTP/oam1lg.example.com@lm.example.com (ArcFour
with HMAC/md5)(0xa3a685f89364d4a5182b028fbe79ac38)
bash-3.2$
```



- c. `kdestroy`
- d. `kinit [-k] [-t <keytab_filename>] [<principal>]`. For example:

```
klist -k -t -K -e FILE:/refresh/home/oam.keytab
```

```
bash-3.2$ kinit -V -k -t /refresh/home/oam.keytab
HTTP/oam1lg.example.com@lm.example.com
Authenticated to Kerberos v5
```

- e. `klist -e`

```
bash-3.2$ klist -e
Ticket cache: FILE:/tmp/krb5cc_8000
Default principal: HTTP/oam1lg.example.com@lm.example.com
```

```
Valid starting Expires Service principal
02/25/12 18:46:55 02/25/12 18:56:55 krbtgt/LM.EXAMPLE.COM@LM.EXAMPLE.COM
Etype (skey, tkt): ArcFour with HMAC/md5, AES-256 CTS mode with 96-bit
SHA-1 HMAC
```

```
Kerberos 4 ticket cache: /tmp/tkt8000
klist: You have no tickets cached
bash-3.2$
```

10. Proceed as follows:

**Successful:** Continue with "[Confirming Access Manager Operations](#)".

**Not Successful:** Stop and resolve the issue which is not related to this integration. Any failure at this point indicates Access Manager WNA cannot work.

### 57.2.1.1 Configuring WNA for Multi-Forest Environment with No Cross-Forest Trust

When trust relationships are not established between forests, you should configure Kerberos authentication for multiple forests or domains using `KerberosPlugin` instead of Kerberos authentication module.

Each forest needs to have a Service Principal Name (SPN) that will be used by OAM to authenticate using WNA. You need to add a KTA Plugin for each forest and specify the SPN corresponding to the forest. For appropriate fallback to KTA Plugins, modify failure and error conditions in the **Steps Orchestration** tab for each KTA Plugin. Meeting the success condition ensures that the Kerberos Token is validated against the specific forest using the specified SPN.

## 57.3 Confirming Access Manager Operations

You need a fully-functioning Access Manager deployment.

The tasks in this section are required regardless of the approach you choose. In this procedure you will install and register a WebGate, which configures an Application Domain to protect resources. Then you verify that the environment is working with an authentication scheme other than Kerberos.

---

### See Also:

*High Availability Guide* for details about high availability environments with two or more Managed Servers configured to operate as a cluster

---

1. Log in to the Oracle Access Management Console using Administrator credentials.

2. Verify the Default Identity Store connection.
3. Register and install WebGate as an OAM Agent and accept automatic policy generation.
4. Add resources to the Application Domain and customize the authentication policy protecting resources to use any Authentication Scheme other than Kerberos.
5. Test the configuration to ensure that resource protection and access are working as expected.
6. Proceed to [Enabling the Browser to Return Kerberos Tokens](#)

## 57.4 Enabling the Browser to Return Kerberos Tokens

You can configure the Internet Explorer or Mozilla Firefox browsers to return Kerberos tokens.

Perform the appropriate procedure on all Active Directory servers. Use either of the following procedures to configure the browsers.

- [Enabling Kerberos Tokens in Internet Explorer](#)
- [Enabling Kerberos Tokens in Mozilla Firefox](#)

---

---

**Note:**

With Internet Explorer browsers, Integrated Windows Authentication is enabled by default and you might not need any changes to the default configuration for WNA to work.

---

---

### 57.4.1 Enabling Kerberos Tokens in Internet Explorer

You can enable Kerberos token in Internet Explorer.

To enable Kerberos token:

1. On a Windows host in the Active Directory domain, sign in as a domain user.
2. Open the Internet Explorer browser.
3. From the Tools menu, click Internet Options, click Security, click Local Intranet, click Advanced.
4. On the Advanced tab, Security section, check the box beside Enable Integrated Windows Authentication, and click OK.
5. Add *Oracle Access Manager CC host or domain name* to Local Intranet zone (use the format `http://node.host:port` (the *port* is not required)). For example:  
  
`http://oam11g.example.com`
6. Restart the Internet Explorer browser to enable the change.

### 57.4.2 Enabling Kerberos Tokens in Mozilla Firefox

You can enable Kerberos tokens in Mozilla Firefox.

To enable Kerberos tokens:

1. In the browser Address bar, enter `about:config`.
2. Add *Oracle Access Manager CC host or domain name* under `network.negotiate-auth.trusted-uris` as: `network.negotiate-auth.trusted-uris=http://oam11g.example.com`

Multiple URIs are separated with a comma.

## 57.5 Integrating KerberosPlugin with Oracle Virtual Directory

Oracle Virtual Directory provides the ability to integrate LDAP-aware applications into diverse directory environments while minimizing or eliminating the need to change either the infrastructure or the applications.

This section provides the tasks you must perform to configure Access Manager KerberosPlugin authentication for WNA with Oracle Virtual Directory.

1. Perform tasks in this section:
  - [Preparing Oracle Virtual Directory for Integration](#)
  - [Registering Oracle Virtual Directory as the Default Store for WNA](#)
  - [Setting Up Authentication with Access Manager KerberosPlugin and OVD](#)
2. [Configuring Access Manager for Windows Native Authentication](#)
3. [Enabling the Browser to Return Kerberos Tokens](#)
4. [Validating WNA with Access Manager Protected Resources](#)

### 57.5.1 Preparing Oracle Virtual Directory for Integration

Oracle Virtual Directory communicates with other directories through adapters. Before you can start using Oracle Virtual Directory as an identity store, you must create adapters to each of the directories you want to use.

The procedure differs slightly, depending on the directory to which you are connecting. If you choose to use Oracle Internet Directory, Active Directory, Oracle Directory Server Enterprise Edition (ODSEE), or Oracle Unified Directory, the required adapters are created and configured while installing and configuring the Oracle Identity Management Server. For more information on managing the adapters, see "Managing Identity Virtualization Library (libOVD) Adapters" in the .

In the following procedure you create an account for the OAM Server in the trusted domain. Additionally, you create two Active Directory Adapters (one for each forest) using the fully-qualified domain names as namespaces. By default Active Directory uses `dc` to construct the root context distinguished name. If this is different in your deployment, adjust your adapter namespaces accordingly.

1. Perform tasks described in "[Confirming Access Manager Operations](#)".
2. Install Oracle Virtual Directory, as described in *Oracle Fusion Middleware Installation Guide for Oracle Identity and Access Management*.
3. In **Oracle Virtual Directory Console**, create two Active Directory Adapters (one for each forest) using the fully-qualified domain names as namespaces as follows:

- a. Adapter 1, EXAMPLE Adapter namespace (domain DNS `lm.example.com`):  
`dc=lm,dc=example,dc=com`
  - b. Adapter 2, SPRITE Adapter namespace (domain DNS `lmsib.sprite.com`):  
`dc=lmsib,dc=sprite,dc=com`
4. Shut down the OAM Cluster.
  5. Restart the AdminServer and all OAM Servers.
  6. Proceed with "[Registering Oracle Virtual Directory as the Default Store for WNA](#)".

## 57.5.2 Registering Oracle Virtual Directory as the Default Store for WNA

Users with valid Oracle Access Management Administrator credentials can register Oracle Virtual Directory as the user store for Access Manager interoperating with Windows Native Authentication.

For Windows Native Authentication, the user credentials must reside in Microsoft Active Directory. Access Directory can be managed by Oracle Virtual Directory instance. For single sign-on with Access Manager, each User Identity Store must be registered to operate with Access Manager.

Typically, `userprincipalname` reflects the Windows login name. For WNA with Access Manager, either leave the User Search Base and Group Search Base blank or provide the distinguished name path that is common to both the adapters configured while performing prerequisite tasks. Before you begin, be sure to complete the sections [About Preparing Your Active Directory and Kerberos Topology](#) and [Confirming Access Manager Operations](#).

1. In the Oracle Access Management Console, click **Configuration** at the top of the window.
2. Click **User Identity Stores**.
3. In the **OAM ID Stores** section, click **Create**.
4. Enter required values for your Oracle Virtual Directory instance. For example:

```
Name: OVD
LDAP Url: ldap://ovd_host.domain.com:389
Principal: cn=Administrator,cn=users,dc=lm,dc=example,dc=com
Credential: *****
User Search Base: dc=com
User Name Attribute: userprincipalname
Group Name: cn
Group Search Base: dc=com
LDAP Provider: Oracle Virtual Directory
```

5. **Default Store:** Click the **Default Store** button to make this the user Identity Store for Access Manager.
6. Click **Apply** to submit the registration, then dismiss the Confirmation window.
7. Restart the AdminServer and OAM Servers.

8. Proceed to "[Setting Up Authentication with Access Manager KerberosPlugin and OVD](#)".

### 57.5.3 Setting Up Authentication with Access Manager KerberosPlugin and OVD

When a native authentication module does not offer enough flexibility for your needs, you can create a custom authentication module using plug-ins designed to meet specific needs.

The `KerberosPlugin` is a credential mapping module that matches the credentials (encrypted username in the Kerberos ticket (SPNEGO token)) of the user who requests the resource. By default, `KerberosPlugin` maps the domain DNS name to the corresponding distinguished name using the `dc` component. However, if the mapping is different, you can specify the correct mapping as a semi-colon (;) separated list of `name:value` tokens. For example:

```
LM.EXAMPLE.COM:dc=lm,dc=example,dc=com;LMSIB.SPRITE.COM:dc=lmsib,dc=sprite,dc=com
```

Users with valid Oracle Access Management Administrator credentials can perform the following task to replace default `KerberosPlugin` steps with steps that enable integration for Windows Native Authentication using the Oracle Access Management Console.

1. In the Oracle Access Management Console, click **Application Security** at the top of the window.
2. Click **Authentication Modules** in the **Plug-ins** section.
3. Click **Search**, locate the **KerberosPlugin** plug-in and open it for editing.
4. On the `KerberosPlugin` page, click the **Steps** tab.

**Steps Tab:** Replace `stepKTA`, as described here, then click **Save**.

- a. Click `stepKTA` then click the **Delete (x)** button to remove this step.
- b. Click the **Add (+)** button and add the following step to the plug-in:

Element	Description
Name	<code>stepKTA</code>
Class	<code>KerberosTokenAuthenticator</code>

#### Step Details:

Edit this new `stepKTA` to change the Step Orchestration value from `NULL` (defined during the step deletion) to its default value of:

```
On Success: StepUIF Failure Failure
```

Also, confirm that this new `stepKTA` includes the parameter `KEY_DOMAIN_DNS2DN_MAP` (created earlier), enter the appropriate values for your deployment and click **Save**.

Element	Description
KEY_DOMAIN_DNS2DN_MAP	Active Directory Forests in your deployment. For example:  LM.EXAMPLE.COM:dc=lm,dc=example,dc=com;LMSIB.SPRITE.COM:dc=lmsib,dc=sprite,dc=com  Note: By default, a DN domain name a.b.c is mapped into dc=a,dc=b,dc=c. Only if the mapping is different, one has to specify the parameter. Otherwise it is best not to use it and let the default behavior take its course.
Service Principal	HTTP/oam11g.example.com@LM.EXAMPLE.COM
keytab.conf	keytab.conf location for stepKTA
krb5.conf	krb5.conf location for stepKTA

5. **stepUIF Details:** Configure as follows and click **Save**:

Element	Description
KEY_LDAP_FILTER	(samAccountName={KEY_USERNAME})
KEY_IDENTITY_STORE_REF	OVD
KEY_SEARCHBASE_URL	Leave this empty

6. **stepUI and stepUA:** Configure as follows and **Save**:

Element	Description
KEY_IDENTITY_STORE_REF	OVD

7. Save the changes.
8. Restart the OAM Cluster.
9. Proceed with "[Configuring Access Manager for Windows Native Authentication](#)".

## 57.6 Integrating the KerberosPlugin with Search Failover

In cases where an Oracle Virtual Directory deployment is not viable, and it is acceptable to perform search failover based on some order or hierarchy when finding the user, you can configure Access Manager.

1. Complete tasks in the following earlier sections:
  - "[About Preparing Your Active Directory and Kerberos Topology](#)"
  - "[Confirming Access Manager Operations](#)" (except "Preparing Oracle Virtual Directory for This Integration", which is not needed for Search Failover)
  - "[Enabling the Browser to Return Kerberos Tokens](#)"
2. Perform tasks in this section:

- ["Registering Microsoft Active Directory Instances with Access Manager"](#)
  - ["Setting Up the KerberosPlugin for ADGCs"](#)
3. ["Configuring Access Manager for Windows Native Authentication"](#)
  4. ["Validating WNA with Access Manager Protected Resources "](#)

## 57.6.1 Registering Microsoft Active Directory Instances with Access Manager

Users with valid Oracle Access Management Administrator credentials can register each Active Directory Global Catalog (ADGC), with relevant search bases and naming attributes, as an individual User Identity Store for Oracle Access Management.

A fully-configured Microsoft Active Directory authentication service should be set up with User accounts for mapping Kerberos services, Service Principal Names (SPNs) for those accounts, and Key tab files. For more information, see *Oracle Fusion Middleware Securing Oracle WebLogic Server 11g Release 1 (10.3.3)*.

1. In the Oracle Access Management Console, click **Configuration** at the top of the window.
2. Click **User Identity Stores**.
3. In the **OAM ID Stores** section, click **Create**.
4. Enter required values for your first ADGC. For example:

```
Name: ADGC1-EXAMPLE
LDAP Url: ldap://ADGC1_host.domain.com:389
Principal: cn=Administrator,cn=users,dc=lm,dc=example,dc=com
Credential: *****
User Search Base: dc=lm,dc=example,dc=com
User Name Attribute: userprincipalname
Group Search Base: dc=lm,dc=example,dc=com
LDAP Provider: AD
```

5. **Default Store:** Click the **Default Store** button.
6. Click **Apply** to submit the changes and dismiss the confirmation window.
7. Repeat these steps to add the second ADGC (ADGC2-SPRITE) with appropriate search bases and naming attributes.

```
Name: ADGC2-SPRITE
LDAP Url: ldap://ADGC2_host.domain.com:389
Principal: cn=Administrator,cn=users,dc=lm,dc=example,dc=com
Credential: *****
User Search Base: dc=lmsib,dc=example,dc=com
User Name Attribute: userprincipalname
Group Search Base: dc=lmsib,dc=example,dc=com
LDAP Provider: AD
```

8. Restart the AdminServer and OAM Servers.

- Proceed to "[Setting Up the KerberosPlugin for ADGCs](#)".

## 57.6.2 Setting Up the KerberosPlugin for ADGCs

When a native authentication module does not offer enough flexibility for your needs, you can create a custom authentication module using plug-ins designed to meet specific needs. The KerberosPlugin is a credential mapping module that matches the credentials (username and password) of the user who requests a resource to the encrypted "Kerberos ticket". By default, KerberosPlugin maps the domain DNS name to the corresponding distinguished name using the dc component.

However, if the mapping is different, you can specify the correct mapping as a semi-colon (;) separated list of name:value tokens. For example:

```
LM.EXAMPLE.COM:dc=lm,dc=example,dc=com;LMSIB.SPRITE.COM:dc=lmsib,dc=sprite,dc=com
```

Users with valid Oracle Access Management Administrator credentials can perform the following task to replace or update KerberosPlugin steps with steps that point to the ADGCs you have created. These will operate in tandem with their counterparts (if the initial step and ADGC fail, the secondary ADGC is used). Before you begin, be sure to complete the sections [About Preparing Your Active Directory and Kerberos Topology](#) and [Confirming Access Manager Operations](#).

- In the Oracle Access Management Console, click **Application Security** at the top of the window.
- Click **Authentication Modules** in the **Plug-ins** section.
- Click **Search**, locate the **KerberosPlugin** plug-in and open it for editing.
- On the KerberosPlugin page, click the **Steps** tab.
 

**Steps Tab:** Replace **stepKTA**, as described here, then click **Save**.

  - Click **stepKTA** then click the **Delete (x)** button to remove this step.
  - Click the **Add (+)** button and add the following step to the plug-in:

Element	Description
Name	<b>stepKTA</b>
Class	<b>KerberosTokenAuthenticator</b>

### New stepKTA Details:

Confirm that this new stepKTA includes the parameter `KEY_DOMAIN_DNS2DN_MAP` (created earlier) and enter values for your deployment:

Element	Description
<code>KEY_DOMAIN_DNS2DN_MAP</code>	LM.EXAMPLE.COM:dc=lm,dc=example,dc=com;LMSIB.SPRITE.COM:dc=lmsib,dc=sprite,dc=com
Service Principal	HTTP/oam11g.example.com@LM.EXAMPLE.COM



Element	Description
keytab.conf	keytab.conf location for stepKTA. For example: /refresh/home/oam.keytab
krb5.conf	krb5.conf location for stepKTA. /etc/krb5.conf

5. **stepUIF: Step Details** (configure as follows and save):

Element	Description
KEY_IDENTITY_STORE_REF	ADGC1-ORACLE
KEY_SEARCHBASE_URL	{KEY_USERDOMAIN}
KEY_LDAP_FILTER	(samAccountName={KEY_USERNAME}) NOTE: For untrusted, multi-domain Active Directory environments, use the userPrincipalName user attribute.

6. **stepUI and stepUA: Step Details** (configure these steps and save):

Element	Description
KEY_IDENTITY_STORE_REF	ADGC1-ORACLE

7. Save the changes.

8. **Add stepUIF2:** This will operate in tandem and execute if stepUIF fails:

Element	Description
KEY_IDENTITY_STORE_REF	ADGC2-SPRITE
KEY_SEARCHBASE_URL	{KEY_USERDOMAIN}
KEY_LDAP_FILTER	(samAccountName= {KEY_USERNAME}) NOTE: For untrusted, multi-domain Active Directory environments, use the userPrincipalName user attribute.

9. **Add stepUI2:** This will operate in tandem and execute if stepUI fails:

Element	Description
KEY_IDENTITY_STORE_REF	ADGC2-SPRITE

10. **Add stepUA2:** This executes when stepUI2 succeeds:

Element	Description
KEY_IDENTITY_STORE_REF	ADGC1-EXAMPLE and ADGC2-SPRITE, respectively

- Add Step Details:** Common Configuration, Plugins, KerberosTokenAutheticator.  
Enter values for your deployment:

Element	Description
keytab.conf	keytab.conf location for stepKTA. For example: /refresh/home/oam.keytab
krb5.conf	krb5.conf location for stepKTA. For example: /etc/krb5.conf

- Restart the OAM Cluster.
- Proceed with "[Configuring Access Manager for Windows Native Authentication](#)".

## 57.7 Configuring Access Manager for Windows Native Authentication

Whether you are using Oracle Virtual Directory or Active Directory with Global Catalogs, this section provides the following topics with steps you can follow:

- [Creating the Authentication Scheme for Windows Native Authentication](#)
- [Configuring Policies for Windows Native Authentication](#)
- [Configuring WNA for NTLM Fallback](#)
- [Configuring WNA Fallback to FORM-based Authentication Scheme](#)
- [Verifying the Access Manager Configuration File](#)

### 57.7.1 Creating the Authentication Scheme for Windows Native Authentication

Users with valid Oracle Access Management Administrator credentials can define an authentication scheme to use in policies protecting applications for Windows Native authentication.

Before you begin, be sure to complete one of the following sections: [Integrating KerberosPlugin with Oracle Virtual Directory](#) or [Integrating the KerberosPlugin with Search Failover](#).

- In the Oracle Access Management Console, click **Application Security** at the top of the window.
- Click **Authentication Schemes** in the **Access Manager** section.
- Under **Search**, type *KerberosScheme* in the **Name** box and click Search.
- Click **KerberosScheme** in the search results to open it.

Set (or confirm) the following attributes:

**Challenge Method:** WNA

**Authentication Module: KerberosPlugin**

5. Finish configuring **KerberosScheme** for your deployment.
6. Click **Apply** and close the confirmation window.
7. Proceed to "[Configuring Policies for Windows Native Authentication](#)".

**57.7.2 Configuring Policies for Windows Native Authentication**

You edit (or create) an Application Domain and policies to protect resources for Windows Native Authentication.

Before you begin, complete [Creating the Authentication Scheme for Windows Native Authentication](#).

1. In the Oracle Access Management Console, click **Application Security** at the top of the window.
2. Click **Application Domains** in the Access Manager section.
3. Open (or Create) the desired Application Domain, as described in "[Managing Application Domains Using the Console](#)".
4. **Resource Definitions:** Add Resource Definitions to the domain as described in "[Adding and Managing Policy Resource Definitions](#)".
5. **Authentication Policies:**
  - a. Open the Authentication Policies node, and open (or Create) the desired Authentication Policy with the following attributes:

Authentication Scheme: **KerbScheme** as the and ensure that it includes the updated **KerberosPlugin**.

Choose **KerbScheme** as the Authentication Scheme and ensure that it includes the updated **KerberosPlugin**.
  - b. Click **Apply**, close the Confirmation window.
  - c. **Resources for Authentication Policy:** Add Resources to the Authentication Policy as described in the *Oracle Fusion Middleware Administrator's Guide for Oracle Access Management*.
  - d. Complete the Authentication Policy with any desired Responses.
6. **Authorization Policies:** Complete the Authentication Policy with any desired Responses or Conditions as described in "[Defining Authorization Policies for Specific Resources](#)".
7. Proceed to "[Verifying the Access Manager Configuration File](#)".

**57.7.3 Configuring WNA for NTLM Fallback**

You can configure Access Manager to use WNA Fallback Authentication upon receiving an NTLM token.

For more information, see [Understanding Access Manager WNA Login and Fall Back Authentication](#).

To configure:

1. Stop the OAM managed server.
2. Back up the following file to a safe location:  
`<WLS domain>/config/fmwconfig/oam-config.xml`
3. Modify `<WLS domain>/config/fmwconfig/oam-config.xml` as follows:

- a. Find the following line:

```
<Setting Name="CredentialCollector" Type="htf:map">
```

- b. After the line, add the following elements (if they are not already present):

```

<Setting Name="WNAOptions" Type="htf:map">
<Setting Name="HandleNTLMResponse" Type="xsd:string">BASIC</Setting>
</Setting>

```

If the following parameter already exists:

```
<Setting Name="HandleNTLMResponse" Type="xsd:string">DEFAULT</Setting>
```

change the `HandleNTLMResponse` value from `DEFAULT` to `BASIC`. For example:

```
<Setting Name="HandleNTLMResponse" Type="xsd:string">BASIC</Setting>
```

4. Restart the OAM server processes.

---

---

**Note:**

See [Two BASIC Authentication Prompts Are Displayed](#) for troubleshooting information.

---

---

## 57.7.4 Configuring WNA Fallback to FORM-based Authentication Scheme

The `OAM_WNA_OPT_OUT` is a host-scoped persisting encrypted cookie set by the OAM Server. This cookie indicates the OAM server to challenge the user with FORM-based authentication when the browser presenting the cookie is not supporting WNA authentication. When set to `TRUE`, the `OAM_WNA_OPT_OUT` cookie makes the OAM server to change the authentication scheme from `DEFAULT` or `BASIC` to FORM-based before displaying the protected resource.

Upon receiving the NTLM tokens, OAM servers fall back to other authentication mechanisms. When `HandleNTLMResponse` is set to `BASIC`, the OAM server falls back to `BASIC` authentication scheme.

The WNA fallback to FORM-based authentication scheme relies on setting the pre-authentication rule. Create a pre-authentication rule that checks for `OAM_WNA_OPT_OUT` cookie which supports WNA FORM fallback mechanism. If the value of the `OAM_WNA_OPT_OUT` cookie is set `TRUE`, the authentication scheme is switched to FORM-based authentication.

1. Stop the OAM managed server.

2. Back up the `<WLS domain>/config/fmwconfig/oam-config.xml` file to a safe location.
3. Edit `<WLS domain>/config/fmwconfig/oam-config.xml` as follows:
 

```
<Setting Name="WNAOptions" Type="htf:map">
<Setting Name="HandleNTLMResponse" Type="xsd:string">FORM</Setting>
</Setting>
```
4. When NTLM and Kerberos authentications do not work with a browser (such as a non-domain attached browser), the OAM Server responds with an authorization error (403) and HTML content in the body of the response. By default, OAM displays an authorization error page with a **Login** button. The user needs to click the **Login** button in the customized page to invoke WNA fallback to FORM-based authentication. You can optionally configure `CustomOptOutPage` or `IsOptOutPersistent` parameters in the `oam-config.xml` and customize the error page.
  - a. Configure the Custom Opt Out Page as follows to emit all the HTML contents from the `oam-config.xml` file. The JavaScript function `optOut()` is invoked when a button in the customized page is clicked. Then OAM emits the JavaScript function `optOut()`.
 

```
<Setting Name="CustomOptOutPage" Type="xsd:string">/home/custom.html</Setting>
```
  - b. The `OAM_WNA_OPT_OUT` cookie is set as persistent cookie, by default. Configure it as a session cookie as follows:
 

```
<Setting Name="IsOptOutPersistent" Type="xsd:boolean">>false</Setting>
```
5. Verify if the value of the `OAM_WNA_OPT_OUT` cookie is set to TRUE and the pre-authentication condition is set as follows:
 

```
str(request.requestMap['Cookie']).lower().find('oam_wna_opt_out=true') >= 0
```
6. Restart the OAM server processes.

The OAM server falls back on FORM-based authentication scheme.

### 57.7.5 Verifying the Access Manager Configuration File

You can verify the Access Manager Configuration file, `oam-config.xml`.

Verify that the following are specified in the `oam-config.xml` file as in the following example:

- path to the `krb5.conf` file
- path to the `keytab` file
- a principal to connect with KDC

`oam-config.xml`

```
<Setting Name="KerberosModules" Type="htf:map">
 <Setting Name="6DBSE52C" Type="htf:map">
 <Setting Name="principal" Type="xsd:string">HTTP/
oam11g.example.com@LM.EXAMPLE.COM
 </Setting>
 <Setting Name="name" Type="xsd:string">XYZKerberosModule</Setting>
 <Setting Name="keytabfile" Type="xsd:string">/refresh/home/oam.keytab
```

```
</Setting>
 <Setting Name="krbconfigfile" Type="xsd:string"/>etc/krb5.conf</Setting>
</Setting>
</Setting>
```

## 57.8 Validating WNA with Access Manager Protected Resources

Integrated Windows Authentication (IWA) is associated with Microsoft products that use SPNEGO, Kerberos, and NTLMSSP authentication protocols included with certain Windows operating systems.

The term Integrated Windows Authentication (IWA) is used for the automatic authentication process that happens between Microsoft Internet Information Services, Internet Explorer, and Microsoft's Active Directory.

---

---

**Note:**

IWA is also known by other names such as HTTP Negotiate authentication, NT Authentication, NTLM Authentication, Domain authentication, Windows Integrated Authentication, Windows NT Challenge/Response authentication and Windows Authentication.

---

---

WNA authentication occurs internally. When integrated with Access Manager:

- The user is redirected to the Access Manager for authentication.
- The OAM Server requests authentication with a `www-negotiate` header when the resource is protected by Access Manager with a challenge method of WNA.
- The browser configured for Integrated Windows Authentication (IWA) sends the Kerberos SPNEGO token to the OAM Server for decryption.
- The OAM Server decrypts the received user SPNEGO token (using keytab) and redirects the user back to the Agent with the cookie and gets access to the resource.

Use this procedure to validate WNA with Access Manager protected resources.

1. Log in to a Windows system in the Active Directory domain as a domain user.
2. Sign in to the Windows OS client using the Windows domain credentials stored in a hosted Active Directory that is registered with Access Manager.
3. Open an Internet Explorer browser window, and enter the URL for the OAM-protected application in your environment.
4. Confirm that you are logged in to the application with your Windows domain credentials with no additional login.

## 57.9 Configuring WNA For Use With DCC

The Kerberos authentication protocol provides a mechanism for mutual authentication between entities before a secure network connection is established.

This section provides information on how to configure Windows Native Authentication and Kerberos to use the DCC with Access Manager. It contains the following topics.

- [Initializing the Kerberos Protocol](#)
- [Configuring Access Manager](#)

**Note:**

See [Understanding Credential Collection and Login](#) for details on DCC.

## 57.9.1 Initializing the Kerberos Protocol

You can initialize Access Manager for the Kerberos protocol.

To initialize:

1. Run the `ktpass` command on the Windows data store, substituting the appropriate values for service, realm, user and user password.

```
ktpass -princ <SPN>@<REALM> -pass <Password> -mapuser <UserName>
-out <Keytab file name>
```

For example:

```
ktpass -princ HTTP/adc.example1.com@EXAMPLE.COM -pass Welcome1 -mapuser
anil@example.com -out foobar2.keytab
```

This command creates an SPN and associates it with the local service account created in the previous step.

**Note:**

Only RC4-HMAC encryption is supported; do not use DES encryption.

2. Copy the keytab output generated by the `ktpass` command and leave it at an appropriate location on the DCC host machine.
3. Modify the `/etc/krb5.conf` file on the DCC host machine accordingly.

For example:

```
[loggings]
default = FILE:/scratch/anikukum/krb/krb5libs.log
kdc = FILE:/scratch/anikukum/krb/krb5kdc.log
admin_server = FILE:/scratch/anikukum/krb/krbadmim.log

[libdefaults]
default_realm = EXAMPLE.COM
ticket_lifetime = 24h
forwardable = yes
dns_lookup_realm = false
dns_lookup_kdc = false
default_tkt_enctypes = rc4-hmac
default_tgs_enctypes = rc4-hmac
permitted_enctypes = rc4-hmac
clockskew = 3600

[realms]
EXAMPLE.COM = {
 kdc = adc.example1.com
```

```
admin_server = adc.example1.com
default_domain = EXAMPLE.COM
}

[domain_realm]
example.com = EXAMPLE.COM.example.com = EXAMPLE.COM
```

---

**Note:**

For multiple domain Active Directory environments, add entries for each domain as documented below.

```
[realms]
EXAMPLE.COM = {
 kdc = adc.example1.com
 admin_server = adc.example1.com
 default_domain = EXAMPLE.COM
}

SPRITE.COM = {
 kdc = lmsib.sprite.com
 admin_server = lmsib.sprite.com
 default_domain = SPRITE.COM
}

[domain_realm]
example.com = EXAMPLE.COM
.example.com = EXAMPLE.COM
sprite.com = SPRITE.COM
.sprite.com = SPRITE.COM
```

---

4. Run the `kinit` command on the DCC host machine to obtain a Kerberos ticket.

```
kinit -k -t <keytab file> <SPN>@<Realm>
```

For example:

```
kinit -k -t foobar1.keytab HTTP/adc.example1.com@EXAMPLE.COM
```

5. Validate the Kerberos ticket on the DCC host machine using the `klist` command.

```
klist
```

## 57.9.2 Configuring Access Manager

You can configure Access Manager to use the Kerberos Authentication Module.

To configure:

1. Modify the Challenge Method of the Kerberos authentication scheme to WNA, if applicable.
  - a. In the Oracle Access Management Console, click **Application Security** at the top of the window.
  - b. In the Launch Pad tab, click **Authentication Schemes** in the **Access Manager** section.
  - c. Search for **KerberosScheme** and click **Edit**.



- d. Change the Challenge Redirect URL to DCC WebGate URL.  
For example, `http://<DCC-WebGate-Hostname>:<Port>/`
      - e. Click **Apply** and close the page.
2. Configure the User Identity Store for LDAP Authentication Module to the configured Windows data store.
  - a. In the Oracle Access Management Console, click **Application Security** at the top of the window.
  - b. In the Launch Pad tab, click **Authentication Modules** in the **Access Manager** section.
  - c. Search for **LDAP** and click **Edit**.
  - d. Change the User Identity Store to, for example, Active Directory.
  - e. Click **Apply** and close the page.
3. Configure the Application Domain protecting the resource to use the Kerberos authentication scheme.

Before accessing the protected resource ensure that its URL is added to the local intranet Site of Security. Additionally, check the Enable Integrated Windows Authentication option under Security in the Advance tab.

## 57.10 Troubleshooting WNA Configuration

This section provides information about the following errors:

- [Kinit Fails](#)
- ["An Incorrect Username or Password was Specified" Is Displayed](#)
- [User Identity Store is Not Registered Correctly](#)
- [Two BASIC Authentication Prompts Are Displayed](#)

---

**See Also:**

Access Manager WNA Quick Start Guide on My Oracle Support, Knowledge Base note 1416903.1 at: <https://support.oracle.com/>

---

### 57.10.1 Kinit Fails

While retrieving initial credentials, the client may not be found in the Kerberos database.

This is the Kerberos version of "User not found" and might be related to one of the following:

- Misspelling or typo of the principal name
- The principal was not added to the Kerberos database, the principal doesn't exist.
- The user name does not exist in Active Directory or has not been registered as a Kerberos user.

- The SPN is not unique.
- On the Active Directory side one or more duplicate entries were found.

The solution would be to have the Active Directory Administrator search the LDAP tree for duplicate entries of the SPN, and remove them.

### 57.10.2 "An Incorrect Username or Password was Specified" Is Displayed

If unable to access a resource protected by Access Manager using the WNA authentication scheme, the error message is displayed.

When the error message, "An incorrect Username or Password was specified" is displayed, check the following.

- An incorrect username or password was specified.
- There is a mismatch in the encryption types being used.
- The key version number (kvno) of the SPN mentioned in the keytab does not match the kvno of the mapped user in the identity store.

### 57.10.3 User Identity Store is Not Registered Correctly

By default, the OAM identity store is Embedded LDAP. If you are using a different identity store (for example, Active Directory or Oracle Unified Directory) be sure to register the identity store.

[Managing Data Sources](#) has complete details on identity stores and how to register them.

- To set the identity store being used as the Default Store, see [About using the System Store for User Identities](#).
- To register the User Identity Store being used, see [Registering a New User Identity Store](#) with details in [User Identity Store Settings](#).

### 57.10.4 Two BASIC Authentication Prompts Are Displayed

If OAM is configured for WNA and the client browser is not configured for IWA, two BASIC authentication prompts might be displayed when accessing a WNA protected resource.

One prompt comes from the Weblogic Server and the second from OAM. To avoid this, the WebLogic Server must be configured to ignore HTTP Basic authentication requests.

1. Stop all WebLogic managed server and the admin server.
2. Create a copy of the config.xml file.  
`$WLS_DOMAIN/config/config.xml`
3. Add the following parameter at the end of the "<security-configuration>" section in the config.xml file.

```
<enforce-valid-basic-auth-credentials>>false</enforce-valid-
basic-auth-credentials>
```

Be sure to add this parameter BEFORE the <cross-domain-security-enabled>>false</cross-domain-security-enabled> parameter.

4. Restart the WebLogic environment.



---

## Integrating JBoss with Access Manager

Oracle provides a J2EE-type JBoss Agent and JBoss Login Module for a smooth integration between Access Manager and JBoss.

This chapter provides the following information to assist you with this integration.

- [Overview of JBoss Integration with Access Manager](#)
- [Understanding the Integration Topology](#)
- [Preparing Your Environment for JBoss 6.x Integration](#)
- [Preparing Your Environment for JBoss 5.x Integration](#)
- [Protecting JBoss-Specific Resources](#)
- [Protecting Web Applications with the JBoss Agent](#)
- [Configuring JBoss Server to Access a Host Name \(not localhost\)](#)
- [Configuring the Login Module to Secure EJBs](#)
- [Configuring the Login Module to Secure Web Service Access](#)
- [Configuring Logging for the JBoss Agent and Login Module](#)
- [Validating Your Configuration](#)

### 58.1 Overview of JBoss Integration with Access Manager

JBoss application server is an open source alternative to the IBM WebSphere and SAP NetWeaver application servers. The JBoss application server and related services are a J2EE platform used for developing and deploying enterprise Java applications, Web applications services, and portals.

J2EE allows the use of standardized modular components and enables the Java platform to handle many aspects of programming automatically. For integration with JBoss, Oracle provides:

- A J2EE type JBoss Agent
- A JAAS-compliant Login Module, which can be used with any client to authenticate against Access Manager

---

**Note:**

There is no special processing within (or by) Access Manager with (or for) the JBoss Agent.

---

Integration between JBoss and Access Manager enables you to:

- Protect Web applications and establish user single sign-on
- Secure EJB access by configuring the login module for EJBs
- Secure Web Services using the login module with Web service handlers to authenticate and authorize the caller

There are no client interfaces. For more information, see the following topics:

- [Configuration and Processing by the JBoss Agent](#)
- [Configuration and Processing by the Login Module](#)

### 58.1.1 Configuration and Processing by the JBoss Agent

The JBoss Agent is a fully capable agent running on the JBoss Server. This JBoss Agent supports Access Manager Web single sign-on flows with (or without) a WebGate.

Authentication and authorization are based on resource URLs defined within Access Manager policies. The JBoss Agent intercepts every incoming request to the OAM Server and checks for access permissions for the requested resource. If the resource is protected by an OAM policy, the JBoss Agent initiates authentication and authorization for the user trying to access the resource.

Whenever an unauthenticated user requests access to any protected resource, the JBoss Agent redirects the user to the credential collector for a user name and password. The username and password that is entered is authenticated by the OAM Server. The JBoss Agent then establishes user session on the JBoss Container using the login module for the user. The login module queries the LDAP directory and fetches the authenticated user principals to set the subject.

---

---

**Note:**

The JBoss Agent depends on the Pure Java ASDK classes and APIs for accessing and communicating with the OAM Server. The JBoss Agent implements the `javax.servlet.Filter` interface. For more information, see the [Access Manager Java API Reference](#).

---

---

The JBoss Agent requires OAM Server communication details, certificate store, and more, which can be configured as:

- A properties file containing all configuration details (the path to this file can be set as a filter parameter)
- The absolute path of the properties file added within the filter configuration in `web.xml`

---

---

**Note:**

The custom headers that are defined by the Oracle Access Management Administrator can only be defined using these methods.

---

---

The application filter should log messages at different logging levels (FATAL, ERROR, WARNING, DEBUG, TRACE). Each level indicates the severity of information logged,

in descending order. The filter should be able to log the detailed trace of an incoming message as one set. The JBoss Agent and the Login Module are both equipped with messages for various log levels. For logging in the same log file (server.log):

```
<category name="<<Component_code_package>>">
 <priority value="FINEST" class="org.jboss.logging.log4j.JDKLevel" />
</category>
```

For example, for ASDK, the category name in the previous tag is oracle.security.am.asdk, as shown:

```
<category name="<<oracle.security.am.asdk>>">
 <priority value="FINEST" class="org.jboss.logging.log4j.JDKLevel" />
</category>
```

The following overview outlines the processing functions for the Access Manager JBoss Agent.

1. Query the OAM Server to check whether the requested resource is protected.
2. Call the OAM Server to retrieve the authentication scheme.
3. Analyze the authentication scheme for the protected resource, and redirect the request to the credential collector.
4. Authenticate the user credentials.
5. Successful Authentication: Set the authentication token generated from the OAM Server in the cookie.
6. Authentication Token: Validate the integrity of the token before servicing the request. Request the OAM Server to verify the user is authorized to access the protected resource and handle the response from the OAM Server accordingly.
7. Depending upon the user requests and OAM Server responses, the JBoss Agent identifies where user requests should be redirected to allow or deny access to the protected resource.

The JBoss Agent is comprised of components described in [Table 58-1](#). Each component uses the Access ASDK to communicate with the OAM Server.

**Table 58-1 JBoss Agent Composition**

Component	Description
Authentication Valve	<p>Invoked during the JBoss Authentication phase for all incoming requests. If the resource is marked as protected by security constraints in the application's Web descriptor, the Authentication Valve checks for the presence of a user principal in the HTTP session:</p> <ul style="list-style-type: none"> <li>Valid User Present: The Authentication Valve evaluates whether the user principal satisfies the security constraints from the application's Web description. If constraints are satisfied, the request proceeds. Otherwise, an authorization failure message is displayed.</li> <li>Valid Single Sign On Cookie Present (ObSSOCookie) (No Valid User): The Authentication Valve verifies the cookie's validity by using the Access Manager Login module (and sets the user principal in the session).</li> <li>No Valid Single Sign On Cookie Present (ObSSOCookie) / No Valid User: The Valve redirects to the OAM Login page when the resource is marked as protected using Access Manager policies.</li> </ul>
Authentication Filter	<p>Invoked for each incoming request following the JBoss authentication phase. For each incoming request, the filter verifies whether a token is present.</p> <ul style="list-style-type: none"> <li>Token Present: The filter uses the ASDK to validate the token.</li> <li>Invalid Token: The filter redirects to the Access Manager Login page.</li> </ul>
Access Manager Login Module	<p>Used internally by the JBoss Agent to authenticate the user based on the SSO token.</p> <p>Any client (stand alone or deployed within the JBoss Container) can use the Login Module to authenticate the incoming user based on username and password or a valid token.</p>

### 58.1.2 Configuration and Processing by the Login Module

The JAAS-compliant Access Manager Login Module is a pluggable authentication module using JAAS APIs provided by the Access Manager `javax.security.*` package. The JAAS-compliant Login Module interfaces enable the client to pass authentication data to the server. The login module is configured with the JBoss server and application to integrate the module with the JBoss application server.

The Login Module implementation class is:

```
public class OAMLoginModule implements LoginModule
```

The standard JAAS packages required by this class are `javax.security.*`. The login module class is stored in a jar file: `$JBOSS_HOME/server/default/lib`.

The `login-config.xml` file is the default JBoss Login Module configuration file. This Login Module requires a JAAS security domain name (`OAMLoginModule`, for instance). Information is stored in `login-config.xml` as a list of named security domains, each of which specifies a number of JAAS Login Modules that are used for authentication within that domain. For example, you add this manually and then restart the JBoss Server.



```

<application-policy name="OAMLoginModule">
 <authentication>
 <login-module code="oracle.security.am.agent.common.jaas.login.OAMLoginModule"
 flag="required">
 <module-option name="loginType">tokenBased</module-option>
 <module-option name="configPath">D:/agentconfig</module-option>
 <module-option name="publicAuthnResourceName">/Authen/Basic</module-option>
 <module-option name="rolesParam">OAM_GROUPS</module-option>
 <module-option name="publicAuthzResourceName">/Authen/SSOToken</module-option>
 </login-module>
 </authentication>
</application-policy>

```

**Note:**

Whenever an application requires security, you must specify the domain name to use in the application's JBoss-specific deployment descriptors (either one or both):

- `jboss.xml`: Defines JBoss-specific configurations for an application.
- `jboss-web.xml`: Defines JBoss for a Web application. This file must declare the security domain and should be placed in the WEB-INF folder.

The JAAS-compliant Login Module consumes either user name/password or Access Manager token. It authenticates and validates the credentials or token with the OAM Server (using the Access Manager Java ASDK APIs) and populates the JAAS subject with user and group information obtained from the OAM Server.

The Login Module can operate in either `usernamePassword` mode or `tokenBased` mode. The following sections provide details.

- [Login Module Process in usernamePassword Mode](#)
- [Login Module Process in tokenBased Mode](#)

### 58.1.3 Login Module Process in usernamePassword Mode

The `usernamePassword` mode authenticates the user based on user name and password or a user and certificate combination that forms a security identity and credential pair.

The Login Module does not directly query the LDAP. Instead the login module uses the OAM Java ASDK to communicate and authenticate the user credentials with the OAM Server; user and group information is retrieved as responses. Following is an overview of the process.

1. Fetches login information.
2. Authenticates the user with Access Manager based on credentials collected by the JBoss Agent.
3. Creates the container session for the client on the server.
4. Sets the JAAS subject with the `userID` and roles.
5. On logout, clears the principal settings of the subject in the session and removes the privilege settings associated with the roles of the subject.

### 58.1.4 Login Module Process in tokenBased Mode

The tokenBased mode sets the Subject by validating the SSO token.

Following is the process flow for setting the Subject:

1. Fetches login information.
2. Validates the SSO authentication token generated from the OAM Server in the cookie.
3. Creates the container session for the client on the server.
4. Sets the JAAS subject with the userID and roles fetched using the existing SSO session token.
5. On logout, clears the principal settings of the subject in the session and removes the privilege settings associated with the roles of the subject.

## 58.2 Understanding the Integration Topology

This section provides the following information.

- [Topology: Access Manager with JBoss Agent](#)
- [Topology: JBoss Agent Behind Web Server Configured with WebGate](#)
- [Sample Integration Topology](#)

### 58.2.1 Topology: Access Manager with JBoss Agent

The JBoss Agent is configured and is deployed in the JBoss Application Server for the clients to access any J2EE application deployed on the JBoss Application Server.

Figure 58-1 illustrates the various clients (whether browser, EJB, or Web service) that can securely access any J2EE application deployed on the JBoss Application Server. The JBoss Agent is configured for this access and is deployed within the JBoss Application Server.

**Figure 58-1** Various Clients Deployed on JBoss Application Server

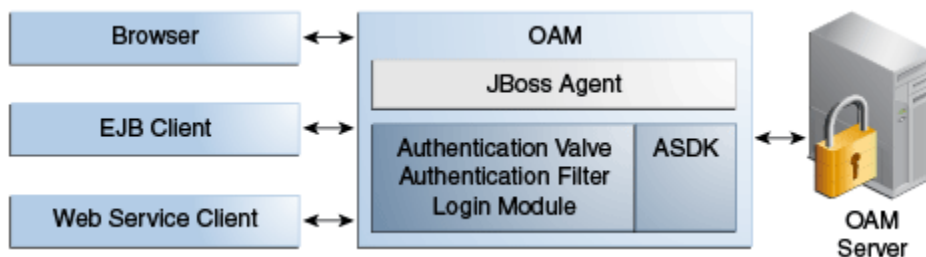

### 58.2.2 Topology: JBoss Agent Behind Web Server Configured with WebGate

In addition to operating alone, the JBoss Agent can also work in conjunction with an Oracle HTTP Server (proxy) configured with a WebGate.

Figure 58-2 illustrates the topology for the JBoss Agent Behind Web Server Configured with WebGate.

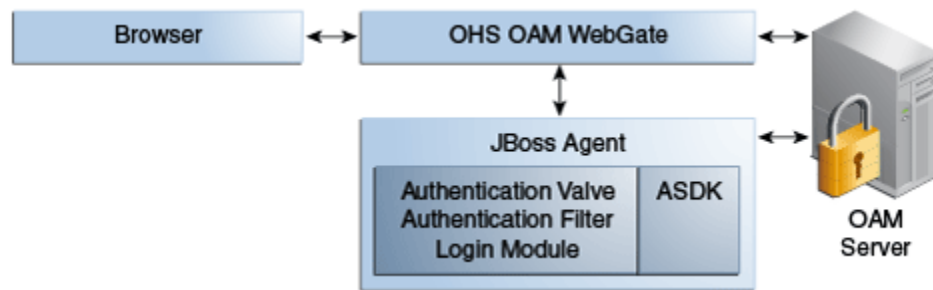
**Figure 58-2 JBoss Agent Deployed with an Oracle HTTP Server WebGate**

Applications are deployed in the JBoss Application Server protected with the JBoss Agent. Additionally the request comes through an Oracle HTTP Server instance that is configured with a WebGate. Both the WebGate and the JBoss Agent are configured against the same Access Manager deployment. Here, the JBoss Agent plays the role of an Identity Asserter that simply validates that the token forwarded by the WebGate is valid and uses the identity established by the WebGate.

### 58.2.3 Sample Integration Topology

Here is the topology for integration between Access Manager and JBoss.

[Figure 58-3](#) illustrates the topology used in this chapter for integration between Access Manager and JBoss.

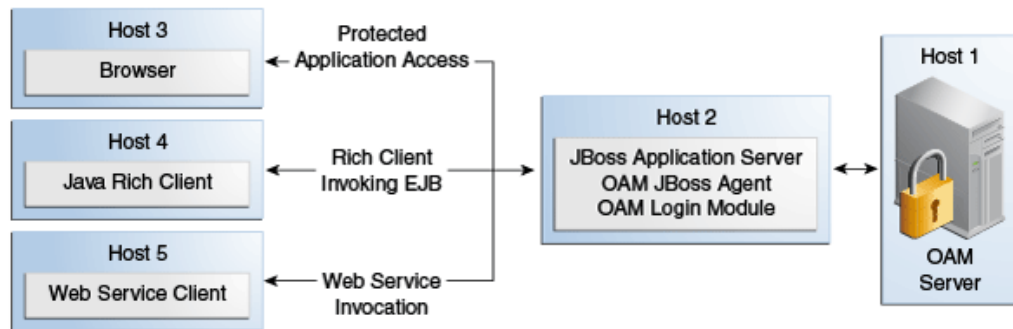
**Figure 58-3 Sample Integration Topology**

Details for this deployment are described in "[Preparing Your Environment for JBoss 5.x Integration](#)".

#### Use Cases

The topology in [Figure 58-3](#) supports:

- **Protecting Web Applications**

This use case is Application specific and JBoss specific. It uses Access Manager SSO with the JBoss Agent and an authorization policy for browsers accessing Web applications on JBoss (with local EJB invocation, if any).

  - Access Manager (Host 1)
  - Application hosted on JBoss Application Server (Host 2)
- **Invoking Secured EJBs using Rich Java Clients**

The client can access an EJB in different ways depending on the client architecture, as follows:

1. Configure the JAAS-compliant Login Module on the JBoss Container to secure access to the EJB. The client can then make use of JBoss-specific mechanism to propagate the Access Manager SSO token to the JBoss Container.

The client can either make use of an already procured Access Manager SSO token or the client can use the JAAS-compliant Access Manager Login Module to obtain the SSO token based on user's credentials.

2. Alternatively, the Access Manager SSO token can be obtained using a custom HTTP Web server-based Access Manager Authentication Service exposed to Rich Java clients.

- **EJB invocation as a Web Service Provider (WSP)**

JAAS-compliant Access Manager Login Module can be configured on the Web Service Provider side to validate the Username and Password or the SSO Token.

*Alternatively:* If only the Username is available for Web Services Consumption (WSC), you need the WSP requiring the SAML token issued by Security Token Service asserting the Username, followed by invocation of JAAS-compliant Access Manager Login Module with extra username-only assertion capability).

- Secure EJB access using the JAAS-compliant Access Manager Login Module on (Host 2)
- Host the EJB Application on the JBoss server (Host 2)
- Access Manager (Host 1)

Remaining sections in this chapter describe how to complete this integration.

## 58.3 Preparing Your Environment for JBoss 6.x Integration

You can integrate JBoss Enterprise Application Platform (EAP) 6.x Application Server with Oracle Access Manager.

It includes information regarding the Access Manager Access SDK and JBoss Agent.

1. Check the latest support information on:

<http://www.oracle.com/technetwork/middleware/ias/downloads/fusion-certification-100350.html>

2. Host 1: Install Access Manager as described in .
3. Host 2:

- a. Install JBoss EAP 6.x Application Server, as described in your JBoss installation guide.
- b. Set JAVA\_HOME environment variable.
- c. Edit JBoss standalone.xml/domain.xml to change host from 127.0.0.1 to 0.0.0.0. For example:

`JBoss_install_directory\standalone\configuration\standalone.xml`

**From**

```
<wsdl-host>${jboss.bind.address:127.0.0.1}</wsdl-host>
```

**To**

```
<wsdl-host>${jboss.bind.address:127.0.0.1}</wsdl-host>
```

4. Host 2: install the Access Manager Access SDK, as described in the *Oracle Fusion Middleware Installation Guide for Oracle Identity and Access Management*.
5. Host 2: create a Global module. For example:
  - a. Create a directory at `JBoss_install_directory\modules\system\layers\base\mymodule\main`
  - b. Create `module.xml`:
 

```
<?xml version="1.0" encoding="UTF-8"?><module xmlns="urn:jboss:module:1.1"
name="mymodule"> <resources> <resource-root path="j2eeagent.jar"/
> <resource-root path="oamasdk-api.jar"/> <resource-root
path="jbossweb-service.jar"/> <resource-root path="jps-api.jar"/>
</resources> <dependencies> <module name="javax.servlet.api"/
> <module name="javax.xml.bind.api"/> <module
name="org.jboss.logging"/><module name="javax.api"/><module
name="org.jboss.as.web"/> </dependencies></module>
```
6. Host 2: install the OAM JBoss Agent.
  - a. Download the JBoss Agent ZIP file and extract the files.  
For supported JBoss EAP 6.x versions, the JBoss agent is supplied as JAR files in patch 19440119. Download the referenced patch from My Oracle Support at <http://support.oracle.com/>.
  - b. From the `/agentconfig/oam_config.properties` file, copy `oam-authenticatorvalve.jar` and `j2eeagent.jar` to `JBoss_install_directory\modules\system\layers\base\mymodule\main`. Download the JBossWeb jar from <http://www.java2s.com/Code/JarDownload/jbossweb/jbossweb-service.jar.zip> and copy its `jbossweb-service.jar` to `JBoss_install_directory\modules\system\layers\base\mymodule\main`
7. Host 2: configure the Global module
  - a. Open `jboss_install_directory/standalone/configuration/standalone.xml` (for standalone) or `domain.xml` (for multi structure)
  - b. Under "jboss:domain:ee" subsystem, add below line:
 

```
<global-modules>
 <module name="mymodule" slot="main"/>
</global-modules>
```
8. Proceed to "[Protecting JBoss-Specific Resources](#)" and do the following procedures.
  - a. "[Registering the JBoss Agent with Automatic Policy Creation](#)"
  - b. "[Creating a Custom Policy for JBoss Resource Protection](#)"
9. Proceed to "[Protecting Web Applications with the JBoss Agent](#)" and do the following procedures.
  - a. "[Creating Configuration Properties for the JBoss Agent](#)"

b. ["Mapping the Filter in the Application's web.xml File"](#)

10. Configure the JBoss Login Module to use Access Manager policies.

- a. Open `jboss_install_directory/standalone/configuration/standalone.xml`(for standalone) or `domain.xml` (for multi structure)
- b. Under the "jboss:domain:security" subsystem, add a new security-domain as follows:

```
<security-domain name="oamrealm" cache-type="default">
 <authentication>
 <login-module code="oracle.security.am.agent.common.
 jaas.login.OAMLoginModule" flag="required">
 <module-option name="loginType" value="tokenBased"/>
 <module-option name="configPath"
 value="/scratch/lovagarw/jboss/config/" />
 <module-option name="publicAuthnResourceName" value="/Authen/Basic"/>
 <module-option name="rolesParam" value="OAM_GROUPS"/>
 <module-option name="publicAuthzResourceName"
 value="/Authen/SSOToken" />
 </login-module>
 </authentication>
</security-domain>
```

- c. Deploy the application.
- d. Start JBoss using the following command:

```
JBoss_install_dir\bin\standalone.bat
```

---



---

**Note:**

- Valve is not currently supported at the Global level.
  - The JBoss agent codebase libraries are not updated during this procedure.
  - Role based authorization in EJB is not working in EAP when trying to create the authentication token on the client side via `OAMLoginModule` and trying to propagate the authentication token to the JBoss server via the `ClientLoginModule` class.
- 
- 

## 58.4 Preparing Your Environment for JBoss 5.x Integration

You can prepare your environment for integrating JBoss Application Server with Access Manager.

To prepare:

1. Check the latest support information on:
 

<http://www.oracle.com/technetwork/middleware/ias/downloads/fusion-certification-100350.html>
2. Host 1: Install Access Manager as described in .
3. Host 2:
  - a. Install JBoss 5.1.0 Application Server, as described in your JBoss installation guide.



For communication between Access Manager and the JBoss Agent, you can use Open, Simple, or Cert Security Mode. Configuring the JBoss Agent to use Simple or Cert mode signals the Java ASDK to operate in the same mode. During registration, a new file system directory is created for the agent on the Oracle Access Management Console host (AdminServer). After registration, you copy artifacts to the Agent directory path:

- ObAccessClient.xml
- password.xml (Simple or Cert mode only)
- oamclient-keystore.jks - see "Setting Up The Keystore" in *Oracle Fusion Middleware Developer's Guide for Oracle Access Management*.

In the following procedure you will create a fresh registration for a 10g OAM Agent. Replace variables with values for your environment. This example uses Cert mode. Your deployment will be different.

1. Go to the Oracle Access Management Console (host 1) and log in using Administrator credentials. For example:

```
https://host1:port/oamconsole
User: adminuserID
Password *****
```

2. Click **Application Security** at the top of the window.
3. In the **Launch Pad** tab, click **SSO Agent Registration** in the **Quick Start Wizards** section.
4. Select **WebGate** as the agent type and click **Next**.
5. Enter the following (and required details) to register this OAM Agent. For example:

- Name: *JBoss*
- Version: **10g**
- Security: Cert (See *Oracle Fusion Middleware Developer's Guide for Oracle Access Management*)
- User-defined Parameter:

```
logoutRedirectUrl=http://OAM_Server.domain.com:14100/oam/server/logout
```

6. **Protected Resource List:** Click the Add (+) button in this table and enter the resources you want protected by the default Authentication and Authorization policies:

```
/Authen/Basic
/Authen/SSOToken
```

7. **Auto Create Policies:** Check to create fresh policies and an Application Domain.
8. Click **Apply** to submit the registration.
9. Check the Confirmation window for the location of generated artifacts and then close the window.
10. In the navigation tree, confirm the Agent name is listed.



11. Copy `ObAccessClient.xml` from the AdminServer to the JBoss Agent installation directory path:

From: `$WLS_HOME/middleware/user_projects/domains/base_domain/output/AGENTNAME`

To: `D:\agentconfig`

12. Proceed with "[Creating a Custom Policy for JBoss Resource Protection](#)".

## 58.5.2 Creating a Custom Policy for JBoss Resource Protection

You can create a custom Authorization policy to protect JBoss Agent-specific resources and add responses that return the user groups as header variables.

For example, name the response `OAM_GROUPS` (with value `$user.groups`).

---



---

### Note:

For this custom authorization policy, the success and failure redirect URLs are not needed because the single purpose of this policy is to provide responses for an authorized user. If redirect URLs are provided, no redirection occurs with the processing logic of the JBoss Agent or Login Module.

---



---

1. In the Oracle Access Management Console, click **Application Security** at the top of the window.
2. In the **Launch Pad** tab, click **Application Domains** in the Access Manager section.
3. Search for the *JBoss* domain and open it for editing.
4. **Authorization Policies:**
  - a. Click the **Authorization Policies** node and click the **Create (+)** button.
  - b. In the **Name** field of the Summary tab, enter a unique name. For example:  
*Custom Authorization Policy*
5. **Add Resources:** JBoss Agent-specific resources were defined during agent registration.
  - a. Click the **Resources** tab on the Authorization Policy page.
  - b. Click the **Add (+)** button.
  - c. Click the **Search** button.
  - d. Choose a URL from the list, then click **Add Selected**:  
*/Authen/Basic*
  - e. Repeat Steps a through d to add:  
*/Authen/SSOToken*
  - f. Click **Apply**
6. **Add Responses:** Click the **Responses** tab, click the **Add (+)** button and:

- In the **Name** field, enter a unique name for this response: *OAM\_GROUPS*.
  - From the **Type** list, choose a response type (**Header**).
  - In the **Value** field, enter a value for this response. For example:  
*\$user.groups*
7. Click **Apply** to save changes and close the Confirmation window.
  8. Proceed to the proper topic for your deployment.
    - [Protecting Web Applications with the JBoss Agent](#)
    - [Configuring the Login Module to Secure EJBs](#)
    - [Configuring the Login Module to Secure Web Service Access](#)

## 58.6 Protecting Web Applications with the JBoss Agent

This section provides the following tasks required to protect Web Applications with the JBoss Agent. Before beginning this section, deploy the application as usual.

- [Creating Configuration Properties for the JBoss Agent](#)
- [Configuring the Authentication Valve](#)
- [Mapping the Filter in the Application's web.xml File](#)
- [Configuring the JBoss Login Module to Use Access Manager Policies](#)

### 58.6.1 Creating Configuration Properties for the JBoss Agent

You copy Jboss Agent registration artifacts from the AdminServer to the JBoss host and create a filter configuration properties file that is referenced later. The JBoss Agent relies on the 11g Java ASDK which operates in the same mode as the registered JBoss Agent.

The JBoss Agent requires a configuration file (*oam\_config.properties*) that defines a number of critical properties. These include the file system path to the agent's registration artifact (*ObAccessClient.xml*), the security domain defined in the JBoss server's login configuration file, parameters and values that return to the JBoss Agent during authentication, and an optional attribute to check for the presence of *authToken* in the request. Use this procedure to create a configuration properties file for the JBoss Agent.

1. Create a JBoss Agent configuration file named *oam\_config.properties* using the following sample as a guide:

```
##Path of the folder containing the ObAccessClient.xml
configPath=D:\agentconfig

##Name of the security domain as configured in JBoss's login-config.xml
realmName=oamrealm

##Optional. If not specified then defaults to /Authen/Basic
##publicAuthnResourceName=/Authen/Basic

##Optional. If not specified then defaults to http
##publicAuthnResourceType=http
```

```

##Optional. If not specified then defaults to GET
##publicAuthnResourceOperation=GET

##Optional. If not specified then defaults to /Authn/SSOToken
##publicAuthzResourceName=/Authn/SSOToken

##Optional. If not specified then defaults to http
##publicAuthzResourceType=http

##Optional. If not specified then defaults to GET
##publicAuthzResourceOperation=GET

rolesParam=OAM_GROUPS

##Optional. This attribute is responsible to check whether the credential in
##the subject / callback handler is an authn token. Defaults to authnToken.
authToken=authToken

#####
OAM logout related properties
#####
##Host name of the OAM 1lg Server
##oamHost=abchost.us.example.com

##Managed server port number of the OAM 1lg Server
##oamPort=Port_value

```

2. Save `oam_config.properties` on the JBoss host:

```
/agentconfig/oam_config.properties
```

3. Proceed to "[Configuring the Authentication Valve](#)".

## 58.6.2 Configuring the Authentication Valve

You can configure the Authentication Valve in one of the two ways that is best suited to your environment.

---



---

### Note:

This procedure is not needed if you are [Preparing Your Environment for JBoss 6.x Integration](#) as the Valve is not currently supported at the Global level.

---



---

To configure the Authentication Valve:

- [Adding the Authentication Valve to context.xml](#): This global configuration causes the Authentication Valve to intercept all requests to the JBoss Agent.
- [Adding the Authentication Valve to the Application's Deployment](#): Rather than adding the Authentication Valve to `context.xml` for global use, you can add a `context.xml` as part of the application's deployment. This configuration affects only the concerned application (the Authentication Valve intercepts requests coming only to this specific application).

### 58.6.2.1 Adding the Authentication Valve to context.xml

You can add the Authentication Valve to `context.xml`.

1. Locate and open for editing the JBoss Agent context.xml file in:

```
JBoss_install_dir\server\default\deploy\jbossweb.sar\context.xml
```

2. Add the following Valve entry and save the file:

```
<Valve
 className="oracle.security.am.agent.common.authenticator.OAMAuthenticatorValve"
 configFile="<full_path_to_oamagent_config_properties_file> " />
```

3. Proceed to [Mapping the Filter in the Application's web.xml File](#)

### 58.6.2.2 Adding the Authentication Valve to the Application's Deployment

You can add the Authentication Valve to the application's deployment.

1. Create a fresh context.xml file and store it under WEB-INF with web.xml:

```
JBoss_install_dir\server\default\deploy\jbossweb.sar\context.xml
```

2. Add the following Valve entry:

```
<?xml version="1.0" encoding="UTF-8"?>

<Context privileged="true">
 <Valve
 className="oracle.security.am.agent.common.authenticator.OAMAuthenticatorValve"
 configFile="<full_path_to_oamagent_config_properties_file> " />
</Context>
```

3. Redeploy the application.
4. Proceed to [Mapping the Filter in the Application's web.xml File](#)

### 58.6.3 Mapping the Filter in the Application's web.xml File

You can add filter mapping for this integration to the application's web.xml.

You also add the name of the filter's configuration properties file.

1. Locate the web.xml file in the application EAR file:

```
my_app/WEB-INF/web.xml
```

2. Add the following filter mapping to the application's web.xml. For example:

```
<filter>
 <filter-name>OAMFilterAgent</filter-name>
 <filter-class>
 oracle.security.am.agent.common.filter.OAMAuthenticationFilter
 </filter-class>
 <init-param>
 <param-name>configFile</param-name>
 <param-value>D:/oam_config.properties</param-value>
 </init-param>
</filter>
<filter-mapping>
 <filter-name>OAMFilterAgent</filter-name>
 <url-pattern>/*</url-pattern>
</filter-mapping>
```

3. Save the file.
4. Proceed to [Configuring the JBoss Login Module to Use Access Manager Policies](#)

## 58.6.4 Configuring the JBoss Login Module to Use Access Manager Policies

This procedure describes the required login module entry for JBoss to use Access Manager policies. After you add filter mapping to web.xml, you redeploy the application and start the JBoss Server.

---



---

### Note:

Starting JBoss Server using `-b 0.0.0.0` allows the user to access the server by the host name rather than `localhost / 127.0.0.1`. Without this parameter, JBoss Server can be accessed using `localhost / 127.0.0.1` as well as the host name.

---



---

1. Locate and open the login-config.xml file:

```
JBoss_install_dir\server\default\conf\login-config.xml
```

2. Add a new entry for the login module, as follows:

```
<application-policy name="oamrealm">
 <authentication>
 <login-module
 code="oracle.security.am.agent.common.jaas.login.OAMLoginModule"
 flag="required">
 <module-option name="loginType">tokenBased</module-option>
 <module-option name="configPath">D:/agentconfig</module-option>
 <module-option>
 <module-option name="publicAuthnResourceName">/Authn/Basic</module-option>
 <module-option name="rolesParam">OAM_GROUPS</module-option>
 <module-option name="publicAuthzResourceName">/Authn/SSOToken</module-
option>
 </login-module>
 </authentication>
</application-policy>
```

The name of `application-policy` in this entry should have the same value as that defined for the `realmname` property in `oam_config.properties`.

3. Deploy the application.
4. Start JBoss as follows using the following command:

```
JBoss_install_dir\bin\run -b 0.0.0.0
```

See [Configuring JBoss Server to Access a Host Name \(not localhost\)](#)

## 58.7 Configuring JBoss Server to Access a Host Name (not localhost)

Configuring JBoss Server to Access a Host Name is optional and required only to access the JBoss Server using the host name (rather than `localhost/127.0.0.1`).

This procedure is not used when [Preparing Your Environment for JBoss 6.x Integration](#)

1. On the JBoss Server host, locate the server.xml file in the following path:

```
JBoss_install_dir\server\default\deploy\jbossweb.sar\server.xml
```

2. Edit server.xml to change the default host, as follows:

**From:**

```
<Engine name="jboss.web" defaultHost="localhost">
```

**To:**

```
<Engine name="jboss.web" defaultHost="defaultHost="0.0.0.0">
```

3. Save server.xml.

---

---

**Note:**

Starting JBoss Server using `-b 0.0.0.0` allows the user to access the server using host name rather than localhost / 127.0.0.1. Otherwise, JBoss Server can be accessed using localhost / 127.0.0.1 as well as host name.

---

---

## 58.8 Configuring the Login Module to Secure EJBs

You can configure the Login Module to secure EJBs.

This task involves both server-side and client-side configuration as documented in following sections.

- [Configuring the Server to Secure EJBs](#)
- [Configuring the Client Side for Login Module to Secure EJBs](#)

---

---

**Note:**

These procedures are not used when [Preparing Your Environment for JBoss 6.x Integration](#).

---

---

### 58.8.1 Configuring the Server to Secure EJBs

On the server side, you must add the security domain annotation to the EJB and add descriptors to jboss.xml. You also add a new entry to the JBoss server configuration file for the Login Module.

Securing EJBs, Web applications or a Web Service based on roles requires additional configuration in login-config.xml as follows:

```
<module-option name="rolesParam">OAM_GROUPS</module-option>
```

Here OAM\_GROUPS is the response configured when "[Creating a Custom Policy for JBoss Resource Protection](#)".

You can use either the agent configured in previous steps or a new agent.

**Note:**

To use a new agent you must copy the `ObAccessClient.xml` from the `/agent` directory on the JBoss host to another directory.

1. Copy `ObAccessClient.xml` as follows (one or the other):

- **From:** `$WLS_HOME/middleware/user_projects/domains/base_domain/output/agent_name`.
- **To:** A directory on the JBoss host.

2. Add the `@SecurityDomain("oamrealm")` annotation to the EJB. For example, if the EJB class is `DemoEJB` the following should be added at the code level:

```
import org.jboss.security.annotation.SecurityDomain;

@SecurityDomain("oamrealm")
public class DemoEJB{ ... }
```

The `application-policy` defined as the value of `@SecurityDomain` (in this example, `oamrealm`) should have the same value as that defined for the `realmname` property in `oam_config.properties`.

3. **Option:** Add the following descriptor to the `jboss.xml` file to define the security domain.

```
META-INF/jboss.xml

<jboss>
 <security-domain>java:/jaas/myother</security-domain>
</jboss>
```

The `application-policy` name defined in this descriptor (`myother`) should have the same value as the `realmname` property defined in `oam_config.properties`.

**Note:**

The name associated with the security domain annotation should be specified in the Login Module to be used, as described in Step 4. See Also: [Configuring the JBoss Login Module to Use Access Manager Policies](#).

## 4. JBoss Server Login Configuration: Add an entry for the Login Module class name, which must be part of the login mechanism:

`JBoss_install_dir\server\default\conf\login-config.xml`

```
<application-policy name="oamrealm">
 <authentication>
 <login-module code="oracle.security.am.agent.common.jaas.login.OAMLoginModule"
 flag="required">
 <module-option name="loginType">tokenBased</module-option>
 <module-option name="configPath">D:/agentconfig</module-option>
 <module-option name="rolesParam">OAM_GROUPS</module-option>
 <module-option name="publicAuthnResourceName">/Authn/Basic</module-option>
 <module-option name="publicAuthzResourceName">/Authn/SSOToken</module-
option>
```

```
</login-module>
</authentication>
</application-policy>
```

---

**Note:**

The name value in the `application-policy` element should match the `realmname` property value defined in `oam_config.properties`.

---

5. Deploy the application.
6. Start JBoss using the following command:

```
JBoss_install_dir\bin\run -b 0.0.0.0
```

See [Configuring JBoss Server to Access a Host Name \(not localhost\)](#)

## 58.8.2 Configuring the Client Side for Login Module to Secure EJBs

You can create a client-login configuration file.

To configure:

1. Copy `ObAccessClient.xml` as follows (one or the other):
  - **New Agent:** From `$MW_HOME/middleware/user_projects/domains/base_domain/output/agent_name` to a folder on the Agent host.
  - **Existing Agent:** From its location on the JBoss host to another directory on the Agent host.
2. On the client host, create a client-login configuration text file as follows:

```
oamauth {
 oracle.security.am.agent.common.jaas.login.OAMLoginModule required
 loginType="usernamePassword"
 configPath="D:/agentconfig"
 publicAuthzResourceName="/Authn/Basic"
 publicAuthzResourceName="/Authn/SSOToken";
};
```

3. Add the following to your entry to configure the login module to propagate identity to the EJB Container:

```
propagate {
 org.jboss.security.ClientLoginModule required
 restore-login-identity="true";
};
```

4. Save the file.

---

**Note:**

Perform Step 5 while invoking EJBs from a Rich Client to ensure that Access Manager performs authentication (using the Pure Java ASDK) and then propagates the credentials to the EJB Application Server.

---



5. **Rich Client:** Add the following to the client code before invoking the EJB from the Client side:

```
System.setProperty("java.security.auth.login.config", authFile);
MyCallbackHandler handler = new MyCallbackHandler(<USERNAME>, <PASSWORD>);
LoginContext lc = new LoginContext("oamauth", handler);
lc.login();
//Fetch the private credentials of type String.class
Set<String> set = lc.getSubject().getPrivateCredentials(String.class);

//Set the SSO Token in callback handler along with the username
handler = new MyCallbackHandler(<USERNAME>, set.iterator().next());
LoginContext lc2 = new LoginContext("propagate", handler);
lc2.login();
```

## 58.9 Configuring the Login Module to Secure Web Service Access

The Web Service Provider may provide for one of the various mechanisms to intercept and handle the incoming web service SOAP message in order to enforce security on the web service invocation.

This task involves both the server-side and client-side configuration as documented in the following sections.

- [Configuring the Server to Secure Web Services Access](#)
- [Configuring the Client to Secure Web Services Access](#)

### 58.9.1 Configuring the Server to Secure Web Services Access

Configuring the Server to Secure Web Services Access involves copying Agent registration artifacts, and adding the Access Manager JAAS-compliant Login Module for Web Service security to the JBoss Server login-configuration file.

---



---

**Note:**

You can use either the agent configured in previous steps or a new agent. To use a new agent you must copy the `ObAccessClient.xml` from the `/agent` directory on the JBoss host, to another directory on this host.

---



---

No specific details are provided for configuring or deploying a Web Service because any of several frameworks can be used to create a Web Service. The provider of the Web Services deployed on the JBoss Container should adhere to the following guidelines in general:

- Include functionality to look for specific headers injected by the client order to retrieve the OAM SSO token.
- Use the OAM JAAS Login Module to validate the OAM SSO token
- If any EJB Session Beans are exposed as Web Services, the JBoss-specific JAAS Login Module `ClientLoginModule` must be used to propagate the OAM token to the EJB container.

Use the following procedure to configure the server to secure Web Services access.

1. Copy `ObAccessClient.xml` as follows (one or the other):

- **Existing Agent:** From its location on the JBoss host to another directory on the Agent host.
  - **New Agent:** From `$MW_HOME/middleware/user_projects/domains/base_domain/output/agent_name` to another directory on the Agent host.
2. Register the SOAP Handler with the Web Service (ideally using the `.wsdd` file).

The `.wsdd` file is generated when the WS stubs are created (and is located inside the application's WEB-INF folder).

3. Edit the JBoss Server login-configuration file to add an entry for the Access Manager JAAS-compliant Login Module for Web Service security, as follows:

`JBoss_install_dir\server\default\conf\login-config.xml`

```
<application-policy name="WSRealm">
 <authentication>
 <login-module code="oracle.security.am.agent.common.jaas.login.OAMLoginModule"
 flag="required">
 <module-option name="loginType">tokenBased</module-option>
 <module-option name="configPath">D:/agentconfig</module-option>
 <module-option name="rolesParam">OAM_GROUPS</module-option>
 <module-option name="publicAuthnResourceName">/Authn/Basic</module-option>
 <module-option name="publicAuthzResourceName">/Authn/SSOToken</module-
option>
 </login-module>
 </authentication>
</application-policy>
```

4. Save the JBoss Server login configuration file.
5. Deploy the application.
6. Start JBoss using the following command:

```
JBoss_install_dir\bin\run -b 0.0.0.0
```

See [Configuring JBoss Server to Access a Host Name \(not localhost\)](#)

7. Proceed to [Configuring the Client to Secure Web Services Access](#)

## 58.9.2 Configuring the Client to Secure Web Services Access

You can configure user authentication with the OAM Server and then create a security header element, containing the SSO token, for the SOAP message.

Ideally, this step is performed before invoking a Web Service method, which means that this code must be added in the client code while invoking the Web Service.

To configure:

1. **On the WS-client:** Perform user authentication with OAM Server and then create a security header element, containing the SSO token, for the SOAP message.
2. Invoke the Web service, as usual.
3. Proceed with "[Configuring Logging for the JBoss Agent and Login Module](#)".

## 58.10 Configuring Logging for the JBoss Agent and Login Module

The JBoss Agent and the Login Module are both equipped with logging messages at various log levels.

To log these messages, you must edit the `joboss-log4j.xml` file as described in this procedure.

1. Locate the `joboss-log4j.xml` file in the following path:

```
$JBOSS_HOME/server/default/conf/joboss-log4j.xml
```

2. Open the file in an editor and add the following information:

```
<appender name="J2EEAGENT"
class="org.jboss.logging.appender.DailyRollingFileAppender">
 <errorHandler class="org.jboss.logging.util.OnlyOnceErrorHandler"/>
 <param name="File" value="\${jboss.server.log.dir}/j2eeagent.log"/>
 <param name="Append" value="true"/>
 <param name="DatePattern" value="'.'yyyy-MM-dd"/>
 <layout class="org.apache.log4j.PatternLayout">
 <param name="ConversionPattern" value="%d %-5p [%c] (%t) %m%n"/>
 </layout>
</appender>

<category name="oracle.security.am.agent.common">
 <appender-ref ref="J2EEAGENT"/>
</category>

<root>
 ...
 <appender-ref ref="J2EEAGENT"/>
</root>
```

3. Save the file.

## 58.11 Validating Your Configuration

There is no specific mechanism to validate your configuration. However, you can manually determine whether the configuration is correctly functioning by doing the following and recognizing the response.

To validate:

1. **Authorized User:** Invoke the Web Service manually by providing the SSO token generated for the user who is authorized to invoke the Web Service.
  - Success: The authorized user is granted access.
  - Failure: The authorized user is denied access.
  - Error: The configuration is incorrect. Review the OAM Server logs for the entries generated by the Login Module.
2. **Unauthorized User:** Invoke the Web Service manually and provide the SSO token for a non-authorized user.
  - Success: The unauthorized user is denied access.
  - Failure: The unauthorized user is granted access.

- Error: If any error occurs, the configuration is incorrect. Review the OAM Server logs for the entries generated by the Login Module.

---

## Integrating Microsoft SharePoint Server with Access Manager

This chapter explains how to integrate Access Manager with a 10g WebGate and Microsoft SharePoint Server. It covers the following topics:

- [What is Supported in This Release?](#)
- [Introduction to Integrating With the SharePoint Server](#)
- [Integration Requirements](#)
- [Preparing for Integration With SharePoint Server](#)
- [Integrating With Microsoft SharePoint Server](#)
- [Setting Up Microsoft Windows Impersonation](#)
- [Completing the SharePoint Server Integration](#)
- [Integrating With Microsoft SharePoint Server Configured With LDAP Membership Provider](#)
- [Configuring Single Sign-On for Office Documents](#)
- [Configuring Single Sign-off for Microsoft SharePoint Server](#)
- [Setting Up Access Manager and Windows Native Authentication](#)
- [Synchronizing User Profiles Between Directories](#)
- [Testing Your Integration](#)
- [Troubleshooting](#)

---

**Note:**

Access Manager with a 10g WebGate supports both Microsoft SharePoint Server 2010 and Microsoft SharePoint Server 2013. Other versions of Microsoft SharePoint Server are not supported in this release.

Unless explicitly stated, all details in this chapter apply equally to Access Manager integration with Microsoft SharePoint Server using the OAM impersonation plug-in, and Microsoft SharePoint Server configured with the LDAP Membership Provider.

---

## 59.1 What is Supported in This Release?

Support for integration between Access Manager and SharePoint enables the following functionality:

- When a user accesses SharePoint before SSO login with Access Manager, the user is prompted for Access Manager SSO login credentials.
- When a user with a valid Access Manager login session wants to access SharePoint documents, he must be established with SharePoint (logged in and authenticated with SharePoint). Once the Access Manager session is established, it is also respected by SharePoint for integration with Access Manager and SharePoint using LDAP Membership Provider, OAM WNA, and impersonation. Based on authentication status, SharePoint either allows or denies access to documents stored in SharePoint.
- When a user opens an Office document from SharePoint using a browser, the SSO session should persist into the MS Office program so that access to the document through the MS Office program is maintained. See "[Configuring Single Sign-On for Office Documents](#)".
- Full feature parity with SharePoint integration with Access Manager 10g is provided to ease upgrades.

---

---

**Note:**

11g WebGates are not supported on the IIS Web server. Only the WebGate 10g WebGate for IIS can be used for this integration.

---

---

## 59.2 Introduction to Integrating With the SharePoint Server

SharePoint Server is a Microsoft-proprietary secure and scalable enterprise portal server that builds on Windows Server Microsoft Internet Information Services (IIS) and Windows SharePoint Services (WSS).

SharePoint Server is typically associated with Web content and document management systems. SharePoint Server works with Microsoft IIS web server to produce sites intended for collaboration, file sharing, web databases, social networking and web publishing. In addition to WSS functionality, SharePoint Server incorporates additional features such as News and Topics as well as personal and public views for My Site, and so on.

Microsoft SharePoint Server enhances control over content, business processes, and information sharing. Microsoft SharePoint Server provides centralized access and control over documents, files, Web content, and e-mail, and enables users to submit files to portals for collaborative work.

SharePoint server farms can host web sites, portals, intranets, extranets, Internet sites, web content management systems, search engine, wikis, blogs, social networking, business intelligence, workflow as well as providing a framework for web application development.

When integrated with Microsoft SharePoint Server, Access Manager handles user authentication through an ISAPI filter and an ISAPI Module. This enables single sign-on between Access Manager and SharePoint Server.

SharePoint Server supports the following authentication methods:

- Form Based Authentication
- Impersonation Based Authentication
- Windows Authentication: Used only for the configuration where the information about the users is stored in Active Directory server

The integrations in this chapter provide single sign-on to Microsoft SharePoint Server resources and all other Access Manager protected resources. For more information, see:

- [About Windows Impersonation](#)
- [Form Based Authentication With This Integration](#)
- [Authentication With Windows Impersonation and SharePoint Server Integration](#)
- [Access Manager Support for Windows Native Authentication](#)

### 59.2.1 About Windows Impersonation

Unless explicitly stated, the integrations described in this chapter rely on Windows impersonation. Windows impersonation enables a trusted user in the Windows server domain to assume the identity of any user requesting a target resource in Microsoft SharePoint Server.

This trusted impersonator maintains the identity context of the user while accessing the resource on behalf of the user.

Impersonation is transparent to the user. Access appears to take place as if the SharePoint resource were a resource within the Access System domain.

---

---

**Note:**

Windows impersonation is not used when integrating Microsoft SharePoint Server configured with the LDAP Membership Provider.

---

---

### 59.2.2 Form Based Authentication With This Integration

You can integrate Access Manager with SharePoint Server using any of the three authentication methods. Given common use of LDAP servers (Sun Directory Server and Active Directory for instance), your integration can include any LDAP server. Form-based authentication in SharePoint Server is claims-aware. When a user enters credentials on the Forms login page of SharePoint Relying Party (RP), these are passed to the SharePoint Security Token Service (STS). SharePoint STS authenticates the users against its membership provider and generates the SAML token, which is passed to SharePoint RP. SharePoint RP validates the SAML token and generates the FedAuth cookie. The user is then allowed to access the SharePoint RP site.

With form-based authentication, the WebGate is configured as an ISAPI filter. The form login page of SharePoint RP is customized such that the user is not challenged to enter the credentials by the SharePoint RP. Also, the membership provider is customized such that it just validates the ObSSOCookie set by the WebGate to authenticate the user.

---

---

**Note:**

The WebGate only supports Form Based Authentication using the HTTP validation method (OAMHTTP validation mode). The ASDK validation method (OAMsdk validation mode) is not supported for Form Based Authentication.

---

---

The following overview outlines the authentication flow for this integration using form-based authentication.

Process overview: Request processing with form-based authentication

1. The user requests access to an SharePoint Server RP site.
2. The WebGate protecting the site intercepts the request, determines if the resource is protected, and challenges the user.
3. The user enters their OAM credentials. Next the OAM WebGate server verifies the credentials from LDAP and authenticates the user.

The WebGate generates the OAM native SSO cookie (ObSSOCookie), which enables single sign-on and sets the User ID header variable (to the user name) in the HTTP request and redirects the user to the SharePoint RP site.

4. The SharePoint RP custom login page is invoked, which sets the user name to the user ID passed in the header variable, and sets the password to the ObSSOCookie value. The login page also automatically submits these credentials to the SharePoint RP site.
5. The SharePoint RP site passes the credentials to SharePoint STS, which invokes the custom membership provider to validate the user credentials.
6. The custom membership provider gets the ObSSOCookie value (passed as a password) and sends it as part of the HTTP request to a resource protected by the WebGate to validate the ObSSOCookie.
7. If the ObSSOCookie is valid, SharePoint STS generates the SAML token and passes it to SharePoint RP.
8. SharePoint RP validates the SAML token and generates the FedAuth cookie. The user is then allowed to access the SharePoint RP site.

### 59.2.3 Authentication With Windows Impersonation and SharePoint Server Integration

Windows impersonation enables a trusted user in the Windows server domain to assume the identity of any user requesting a target resource in SharePoint Portal Server. The trusted impersonator maintains the identity context of the user while accessing the resource on behalf of the user. Impersonation is transparent to the user. Access appears to take place as if the SharePoint resource were a resource within the OAM Server domain. Windows based integration with SharePoint Server 2010 and 2013 is the same as the supported integration with SharePoint 2007.

With the SharePoint 2007 integration, the Access Manager ISAPI extension (`IISImpersonationExtension.dll`) was used. Because the internal architecture of event handing changed with SharePoint 2010, Access Manager has changed the ISAPI extension to an HTTP module.

The next overview identifies the authentication processing flow with SharePoint Server and Windows impersonation enabled.



Process overview: Integration Authentication with Windows Impersonation

1. The user requests access to a SharePoint Portal Server resource.
2. The WebGate ISAPI filter protecting SharePoint Portal Server intercepts the request, determines whether the target resource is protected, and if it is, challenges the user for authentication credentials.
3. If the user supplies credentials and the OAM Server validates them, the WebGate sets an ObSSOCookie in the user's browser, which enables single sign-on. The WebGate also sets an HTTP header variable named "impersonate," whose value is set to one of the following:
  - the authenticated user's LDAP uid
  - samaccountname, if the user account exists in Active Directory
4. The Access Manager HTTP module `IISImpersonationModule.dll` checks for the Authorization Success Action header variable named `impersonate`.
5. When the header variable exists, the Oracle ISAPI module obtains a Kerberos ticket for the user.

This Service for User to Self (S4U2Self) impersonation token enables the designated trusted user to assume the identity of the requesting user and obtain access to the target resource through IIS and the SharePoint Portal Server.

## 59.2.4 Access Manager Support for Windows Native Authentication

Access Manager provides support for Windows Native Authentication (WNA).

Your environment may include:

- Windows 2008/R2 or 2012/R2 server
- Internet Information services (IIS) 7.x or 8.x
- Active Directory

If the user's directory server has, for example, an NT Logon ID, or if the user name is the same everywhere, then a user is able to authenticate into any directory server. The most common authentication mechanism on Windows Server 2008 is Kerberos.

The use of WNA by Access Manager is seamless. The user does not notice any difference between a typical authentication and WNA when they log on to their desktop, open an Internet Explorer (IE) browser, request a protected web resource, and complete single sign-on.

Process overview: Using WNA for authentication

1. The user logs in to the desktop computer, and local authentication is completed using the Windows Domain Administrator authentication scheme.
2. The user opens an Internet Explorer (IE) browser and requests an Access System-protected Web resource.
3. The browser notes the local authentication and sends a Kerberos token to the IIS Web server.

---

---

**Note:**

Ensure that Internet Explorer's security settings for the Internet and (or) intranet security zones are adjusted properly to allow automatic logon.

---

---

4. The WebGate installed on the IIS Web server sends the Kerberos token to the OAM 11g sever. The OAM 11g Server negotiates the Kerberos token with the KDC (Key distribution center).
5. Access Manager sends authentication success information to the WebGate.
6. The WebGate creates an ObSSOCookie and sends it back to the browser.
7. Access Manager authorization and other processes proceed as usual.  
The maximum session time-out period configured for the WebGate is applicable to the generated ObSSOCookie.

## 59.3 Integration Requirements

Unless explicitly stated, this section introduces components required for integrations described in this chapter. It includes the following topics:

- [Requirements Confirmation](#)
- [Required Access Manager Components](#)
- [Required Microsoft Components](#)

### 59.3.1 Requirements Confirmation

References to specific versions and platforms are for demonstration purposes. For the latest Access Manager certification information, see the certification matrix on Oracle Technology Network at:

<http://www.oracle.com/technetwork/middleware/ias/downloads/fusion-certification-100350.html>

### 59.3.2 Required Access Manager Components

Access Manager provides access and security functions, including Web-based single sign-on, policy management, reporting, and auditing.

When integrated with Microsoft SharePoint Server, Access Manager handles user authentication through an ISAPI filter and an ISAPI Module, which enables single sign-on between the two products. The components in [Table 59-1](#) are required to integrate with Microsoft SharePoint Server (or Microsoft SharePoint Server configured with LDAP Membership Provider.)

**Table 59-1 Component Requirements**

Component	Description
10g WebGate	<p>The ISAPI version 10g WebGate must reside on the same computer as the SharePoint Server.</p> <p>Within the context of this integration, this WebGate is an ISAPI filter that intercepts HTTP requests for Web resources and forwards them to the OAM Server to authenticate the user who made the request. If authentication is successful, the WebGate creates an ObSSOCookie and sends it to the user's browser, thus facilitating single sign-on. The WebGate also sets impersonate as a HeaderVar action for this user session.</p> <p><b>For LDAP Membership Provider Scenario:</b> See <a href="#">"Integrating With Microsoft SharePoint Server Configured With LDAP Membership Provider"</a>.</p>
IISImpersonationModule.dll	<p>This IIS-native module is installed with the WebGate. The IISImpersonationModule.dll module determines whether the Authorization Success Action HeaderVar has been set to impersonate and, if it has, the DLL file creates a Kerberos S4U2Self ticket that enables the special trusted user in the SharePoint Server Active Directory to impersonate the user who originally made the request.</p> <p>After a WebGate installation, you must configure IISImpersonationModule.dll manually to enable impersonation and this integration.</p> <p><b>For LDAP Membership Provider Scenario:</b> Do not configure IISImpersonationModule.dll.</p>
Directory Server	<p>Access Manager can be connected to any supported directory server including, but not limited to, LDAP and Active Directory. Access Manager can even connect to the same instance of Active Directory used by SharePoint Server.</p> <p>In any case, the directory is not required on the same machine as SharePoint Server and the protecting WebGate.</p>
OAM Server	<p>The integration also requires installation of the OAM Server with which the WebGate protecting your SharePoint Server installation is configured to inter-operate.</p> <p>Except for the WebGate protecting SharePoint Server, your components do not need to reside on the machine hosting SharePoint Server.</p> <p>See Also: <a href="#">"Preparing for Integration With SharePoint Server"</a>.</p>

### 59.3.3 Required Microsoft Components

Minimum requirements dictate a 64-bit, four cores processor.

However, references to specific versions and platforms are for demonstration purposes. For the latest Access Manager certification information, see the following Microsoft library location for Microsoft SharePoint Server:

<https://technet.microsoft.com/en-us/library/cc262485.aspx>

The SharePoint multi-purpose platform allows for managing and provisioning of intranet portals, extranets, and Web sites; document management and file management; collaboration spaces; social networking tools; enterprise search and intelligence tooling; process and information integration; and third-party developed solutions.

---



---

**Note:**

Minimum requirements dictate a 64-bit, four cores processor. However, references to specific versions and platforms are for demonstration purposes. For the latest Access Manager certification information, see Oracle Technology Network at:

<http://www.oracle.com/technetwork/middleware/ias/downloads/fusion-certification-100350.html>

---



---

Table 59-2 describes the other components required for this integration.

---



---

**See Also:**

The following library location for Microsoft SharePoint Server and access to applicable software:

<http://technet.microsoft.com/en-us/library/cc262485.aspx>

---



---

**Table 59-2 Microsoft Requirements for this Integration**

Component	Description
Custom Login Page for SharePoint site	When the user tries to access a SharePoint site configured to use Form Based Authentication, the user is redirected to a login page where the user enters his or her credentials (user name and password). The custom login page passes the credentials to the SharePoint site.
SharePoint site	You create the SharePoint site using the SharePoint Central Administration application. The site is configured to use Form Based Authentication as the authentication method by following the steps mentioned in <a href="http://technet.microsoft.com/en-us/library/ee806890.aspx">http://technet.microsoft.com/en-us/library/ee806890.aspx</a> .  The SharePoint site passes the user credentials to the SharePoint STS that generates SAML token upon successful ObSSOCookie validation by the custom membership provider. The SharePoint site also generates FedAuth cookie upon receiving the SAML token from SharePoint STS. The SharePoint site passes the FedAuth cookie to the user so that he/she can access the SharePoint site.
SharePoint Security Token Service (STS)	The SharePoint site passes the user credentials (user name and password) to SharePoint STS, which invokes the custom membership provider and passes the credentials to it. Once the custom membership provider validates the ObSSOCookie passed to it, the SharePoint STS generates the SAML token for the user that is passed to the SharePoint Relying Party (RP).

**Table 59-2 (Cont.) Microsoft Requirements for this Integration**

Component	Description
Custom Membership Provider for SharePoint STS	<p>The SharePoint STS invokes the membership provider (configured with Form Based Authentication). STS passes the user credentials and the URL for the IIS resource (configured in <code>web.config</code> on the SharePoint site) to the custom membership provider for cookie validation.</p> <p>The membership provider is customized such that it returns success if the <code>ObSSOCookie</code> value passed to it is valid.</p> <p>The custom membership provider library (<code>OAMCustomMembershipProvider.dll</code>) is packaged and installed with the 10g WebGate for IIS Web server. You must deploy the library in the global assembly cache of the SharePoint Server host.</p> <p>The <code>CustomMembershipProvider</code> class is derived from <code>LdapMembershipProvider</code> class present in the <code>Microsoft.Office.Server.Security</code> namespace.</p>
IIS resource for Cookie validation	<p>Configure the URL for the IIS resource in the SharePoint site's <code>web.config</code> file.</p> <p>For the HTTP validation method, the WebGate intercepts the request sent by the custom membership provider, extracts the <code>ObSSOCookie</code> from the request, and validates it. If the cookie is valid, then the request is redirected to the IIS resource, which returns the response with a 200 (OK) status code to the custom membership provider. Otherwise, a 403 (Forbidden) error code is returned to the custom membership provider.</p>

## 59.4 Preparing for Integration With SharePoint Server

The ISAPI 10g WebGate must be installed on the same computer as the SharePoint Server. Other components in this integration can reside on the same host as the WebGate or any other computer in your deployment (Solaris, Linux, or Windows platforms).

Tasks in the following procedure are required for all integration scenarios described in this chapter.

After installing and testing Microsoft components, perform steps here to install Access Manager for your integration. This task applies to both integration scenarios in this chapter. To avoid repetition, information here is not repeated elsewhere.

A different host can be set up for Active Directory or some other directory service. If both Access Manager and SharePoint Server are set up for different instances of Active Directory, both instances must belong to the same Active Directory domain.

### Prerequisites

Install and test Microsoft components described in "[Required Microsoft Components](#)".

To prepare for integration with SharePoint Server

1. Install Oracle Identity Management and Access Manager as described in the .
2. Register a 10g WebGate for IIS Web server with Access Manager:
  - a. Log in to the Oracle Access Management Console. For example: `http://host:port/oamconsole`.

- b. Click **Application Security** at the top of the window.
- c. In the **Launch Pad** tab, click **SSO Agent Registration** in the **Quick Start Wizards** section.
- d. Select **WebGate** as the agent type and click **Next**.
- e. Set the agent version to **10g** and enter required details (those with an \*):

Name  
SharePoint user name and password  
Security mode (Agent host must match OAM Server)  
Auto Create Policies (Checked)

---

---

**Note:**

Do not specify a Base URL.

---

---

- f. **Protected Resource List:** In this table, enter individual resource URLs to be protected by this OAM Agent.
  - g. **Public Resource List:** In this table, enter individual resource URLs to be public (not protected).
  - h. Click **Apply** to submit the registration, check the Confirmation window for the location of generated artifacts, then close the window.
3. Proceed as follows:
- **Install a fresh WebGate:** Continue with steps 6, 7, and 8.
  - **Existing WebGate on SharePoint Host:** Skip to "[Integrating With Microsoft SharePoint Server](#)".
- 
- 

**Note:**

Only 64-bit ISAPI WebGates are supported as described in "[Integrating With Microsoft SharePoint Server Configured With LDAP Membership Provider](#)".

---

---

4. Locate and download the 64-bit ISAPI WebGate installer as follows:
  - a. Go to Oracle Fusion Middleware 11gR1 Software Downloads at:  
[https://www.oracle.com/technology/software/products/middleware/htdocs/fmw\\_11\\_download.html](https://www.oracle.com/technology/software/products/middleware/htdocs/fmw_11_download.html)
  - b. Click **Accept License Agreement**, at the top of the page.
  - c. From the **Access Manager Webgates (10.1.4.3.0)** row, click the download link for the desired platform and follow on-screen instructions.
  - d. Store the WebGate installer in the same directory as any 10g (10.1.4.3) Access System Language Packs you want to install.
5. Launch the WebGate installer for your platform, installation mode, and Web server.

Follow these steps:

- a. Follow on-screen prompts.
  - b. Provide Administrator credentials for the Web server.
  - c. **Language Pack**—Choose a Default Locale and any other Locales to install, then click Next.
  - d. WebGate installation begins (IISImpersonationModule.dll will be installed in *WebGate\_install\_dir\access\oblix\apps\Webgate\bin\*).
6. Before updating the Web server configuration, copy WebGate artifacts from the Admin Server to the computer hosting the WebGate.

- a. On the computer hosting the Oracle Access Management Console (AdminServer), locate and copy ObAccessClient.xml (and any certificate artifacts):

```
$DOMAIN_HOME/output/$Agent_Name/
```

```
ObAccessClient.xml
```

```
password.xml (if needed)
```

```
aaa_key.pem (your private key generated by openSSL)
```

```
aaa_cert.pem (signed certificates in PEM format)
```

- b. On the OAM Agent host, add the artifacts to the WebGate path. For example:

```
WebGate_install_dir/access/oblix/lib/ObAccessClient.xml
```

```
WebGate_install_dir/access/oblix/config
```

- c. Restart the WebGate Web server.
  - d. (Optional.) Restart the OAM Server that is hosting this Agent. This step is recommended but not required.
7. Proceed as needed to complete this integration within your environment:
- [Integrating With Microsoft SharePoint Server](#)
  - [Integrating With Microsoft SharePoint Server Configured With LDAP Membership Provider](#)

## 59.5 Integrating With Microsoft SharePoint Server

You can integrate with Microsoft SharePoint Server by creating a new Web application or site application.

The following overview outlines the tasks that you must perform for this integration and the topics where you will find the steps and details.

The custom membership provider library (OAMCustomMembershipProvider.dll) is packaged and installed with the 10g WebGate for IIS Web Server. You must deploy the library in the global assembly cache of the computer hosting SharePoint Server as outlined next.

Task overview: Integrating with Microsoft SharePoint Server includes

1. Performing prerequisite tasks:

- Installing "[Required Microsoft Components](#)".
  - "[Preparing for Integration With SharePoint Server](#)"
2. Creating a new Web application (or site application) in SharePoint Server is described in following topics:
    - "[Creating a New Web Application in Microsoft SharePoint Server](#)"
    - [Creating a New Site Collection for Microsoft SharePoint Server](#)
  3. "[Setting Up Microsoft Windows Impersonation](#) " (not used with LDAP Membership Provider).
  4. "[Completing the SharePoint Server Integration](#)".
  5. "[Configuring Single Sign-off for Microsoft SharePoint Server](#)".
  6. "[Synchronizing User Profiles Between Directories](#)".
  7. "[Testing Your Integration](#)".

### 59.5.1 Creating a New Web Application in Microsoft SharePoint Server

You can create a New Web Application in Microsoft SharePoint Server with or without LDAP Membership Provider.

You perform this task when integrating with Microsoft SharePoint Server, with or without LDAP Membership Provider.

Prerequisites

Installing Microsoft components. See "[Required Microsoft Components](#)".

To create a new Web application in Microsoft SharePoint Server

1. On the host where SharePoint Server is installed, open the Central Administration home page: Start, All Programs, SharePoint Products, SharePoint, Central Administration.
2. From the Central Administration home page, click Application Management.
3. From the Application Management page, Web Applications section, click Manage Web Applications.
4. In the top-left corner, click the New button to create a new web application.
5. Configure the items in [Table 59-3](#) on the Create New Web Application page:

**Table 59-3 Create Web Application Options for Microsoft SharePoint Server**

Section	What You Configure in This Section
Authentication	In this section you select either Claim Based Authentication or Classic Mode Authentication, as appropriate.



**Table 59-3 (Cont.) Create Web Application Options for Microsoft SharePoint Server**

Section	What You Configure in This Section
IIS Web Site	<p>In this section you configure the following settings for your new Web application, as follows:</p> <ul style="list-style-type: none"> <li>• To choose an existing Web site, click Use an Existing Web Site...</li> <li>• To create a new site, click Create.</li> <li>• In the Port field, enter the port number you want to use to access the Web application. For a new Web site, this field contains a default port number. For an exiting site, this field contains the currently configured port number.</li> <li>• In the optional Host Header field, enter the URL for accessing the Web application.</li> <li>• In the Path field, enter the path to the directory that contains the site on the server. For a new Web site, this field contains a default path. For an exiting site, this field contains the current path.</li> </ul>
Security Configuration	<p>In this section you configure authentication and encryption for your Web application, as follows:</p> <ul style="list-style-type: none"> <li>• In the Authentication Provider section, select <b>Negotiate(Kerberos)</b> or <b>NTLM</b>, as appropriate.</li> <li>• In the <b>Allow Anonymous</b> section, choose <b>Yes</b> or <b>No</b>. A value of <b>Yes</b> allows anonymous access to the Web site by using a computer-specific anonymous access account. The account name is <i>IUSR_computername</i>.</li> <li>• In the Secure Sockets Layer (SSL) section, choose <b>Yes</b> or <b>No</b>. If you choose to enable SSL for the Web site, you must configure SSL by requesting and installing a certificate.</li> </ul>
Public URL	<p>Enter the URL for the domain name for all sites that users will access in this Web application. This URL domain will be used in all links shown on pages in the Web application. By default, the box is populated with the current server name and port. The Zone field is automatically set to Default for a new Web application and cannot be changed from this page.</p>

**Table 59-3 (Cont.) Create Web Application Options for Microsoft SharePoint Server**

Section	What You Configure in This Section
Application Pool	<p>In the Application Pool section, choose whether to use an existing application pool or create a new application pool for this Web application, as follows:</p> <ul style="list-style-type: none"> <li>To use an existing application pool, select Use Existing Application Pool, then select the application pool you wish to use from the drop-down menu.</li> <li>To create a new application pool, select Create a New Application Pool, and in the Application Pool Name field, type the name of the new application pool, or keep the default name.</li> </ul> <p>In the section Select a Security Account for This Application Pool, select Predefined to use an existing application pool security account, then select the security account from the drop-down menu. To use a security account that is not currently being used for an existing application pool, select Configurable, enter the user name of the account you want to use in the User Name field, and enter the password for the account in the Password field.</p>
Database Name and Authentication	<p>In this section, choose the database server, database name, and authentication method for your new Web application.</p> <p>In the Database Name field, enter the name of the database or use the default entry. In the Database Authentication field, choose whether to use Windows authentication (recommended) or SQL authentication, as follows:</p> <ul style="list-style-type: none"> <li>If you want to use Windows authentication, leave this option selected.</li> <li>If you want to use SQL authentication, select SQL authentication. In the Account field, type the name of the account that you want the Web application to use to authenticate to the SQL Server database, then type the password in the Password field.</li> </ul>
Failover Server	You can optionally choose to specify a fail-over database server to configure a Fail-over Server.
Service Application Connections	You can use the default value or choose custom value and optionally select the services you want your web application to connect to.

- Click OK to create the new Web application, or click Cancel to cancel the process and return to the Application Management page.
- Proceed with "[Creating a New Site Collection for Microsoft SharePoint Server](#)".

## 59.5.2 Creating a New Site Collection for Microsoft SharePoint Server

You can create a new site collection for Microsoft SharePoint Server with or without LDAP Membership Provider.

### To create a new site collection for Microsoft SharePoint Server

- From the Application Management page, Site Collection section, click Create Site Collections.

2. On the Create Site Collection page, in the Web Application section, either select a Web application to host the site collection (from the Web Application drop-down list), or create a new Web application to host the site collection, as follows:

**NOT\_SUPPORTED**

Section	What You Configure in This Section
Quota Template	You can decide to use predefined quota template to limit resources used for this site collection or use "No quota" as appropriate.
Title and Description	Enter a title and description for the site collection
Web Site Address	Select a URL type, and specify a URL for the site collection.
Template	Select a template from the tabbed template control.
Primary Site Collection Administrator	Enter the user account name for the user you want to be the primary Administrator for the site collection.  You can also browse for the user account by clicking the book icon to the right of the text box. You can verify the user account by clicking the check names icon to the right of the text box.
Secondary Site Collection Administrator (optional)	Enter the user account for the user that you want to be the secondary Administrator for the site collection.  You can also browse for the user account by clicking the book icon to the right of the text box. You can verify the user account by clicking the Check Names icon to the right of the text box.

3. Refer to the following topics as you finish this integration:

- ["Setting Up Microsoft Windows Impersonation "](#)
- ["Completing the SharePoint Server Integration"](#)
- ["Configuring Single Sign-off for Microsoft SharePoint Server"](#)
- ["Synchronizing User Profiles Between Directories"](#)
- ["Testing Your Integration"](#)

**See Also:**

["Task overview: Integrating with Microsoft SharePoint Server Configured with LDAP Membership Provider"](#)

## 59.6 Setting Up Microsoft Windows Impersonation

If you want to use a directory server other than Active Directory, use LDAP Membership provider. The OAMCustomMembership provider leverages the functionality of LDAP Membership provider.

This section describes how to set up impersonation, whether for SharePoint Server integration or for use by some other application.

---

**Note:**

Skip this section if you are integrating Microsoft SharePoint Server configured with LDAP Membership Provider. Windows impersonation is not used with the LDAP Membership Provider.

---

**Task overview: Setting up impersonation**

1. Create a trusted user account for only impersonation in the Active Directory connected to SharePoint Server, as described in "[Creating Trusted User Accounts](#)".
2. Give the trusted user the special right to act as part of the operating system, as described in "[Assigning Rights to the Trusted User](#)".
3. Bind the trusted user to the WebGate by supplying the authentication credentials for the trusted user, as described in "[Binding the Trusted User to Your WebGate](#)".
4. Add a header variable named *IMPERSONATE* to the Authorization Success Action in the Application Domain for impersonation, as described in "[Adding an Impersonation Response to an Authorization Policy](#)".
5. Configure IIS by adding the `IISImpersonationModule.dll` to your IIS configuration, as described in "[Adding an Impersonation DLL to IIS](#)".
6. Test impersonation, as described in "[Testing Impersonation](#)".

### 59.6.1 Creating Trusted User Accounts

You can create trusted user accounts. The special user should not be used for anything other than impersonation.

The example in the following procedure uses *Impersonator* as the New Object - User. Your environment will be different.

To create a trusted user account:

1. Perform the following steps on the computer hosting your SharePoint Server installation:
  - Windows 2008: Select Start, Programs, Administrative tools, Active Directory Users and Computers.
2. In the Active Directory Users and Computers window, right-click Users on the tree in the left pane, then select New, User.
3. In the First name field of the pane entitled New Object - User, enter an easy-to-remember name such as *Impersonator*.
4. Copy this same string to the User logon name field, then click Next.
5. In succeeding panels, you will be asked to choose a password and then retype it to confirm.

**Note:**

Oracle recommends that you chose a very complex password, because your trusted user is being given very powerful permissions. Also, be sure to check the box marked Password Never Expires. Since the impersonation module should be the only entity that ever sees the trusted user account, it would be very difficult for an outside agency to discover that the password has expired.

**Figure 59-1** Setting up a Trusted User Account for Windows Impersonation

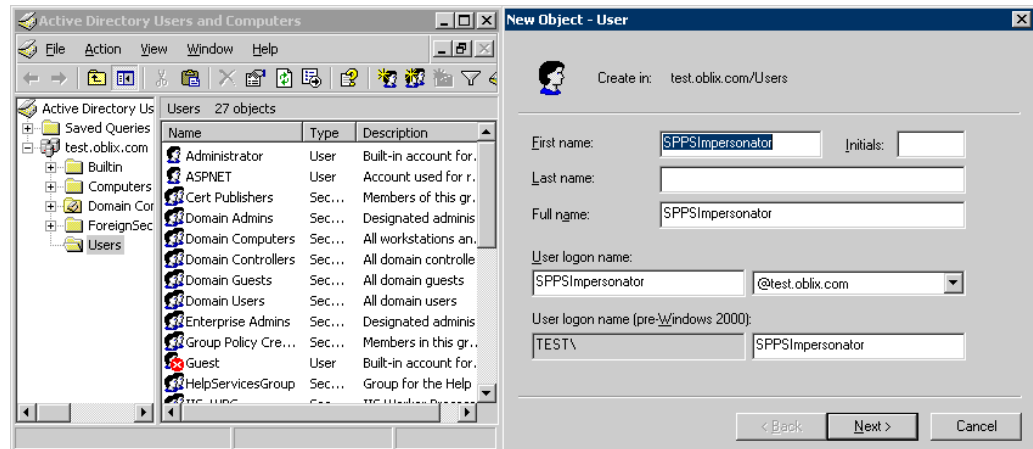

## 59.6.2 Assigning Rights to the Trusted User

You need to give the trusted user the right to act as part of the operating system.

To give appropriate rights to the trusted user:

1. Perform steps for your environment:
  - Windows 2008: Select Start, Programs, Administrative tools, Local Security Policy.
2. On the tree in the left pane, click the plus icon (+) next to Local Policies.
3. Click **User Rights Assignment** on the tree in the left pane.
4. Double-click Act as part of the operating system in the right pane.
5. Click **Add User or Group**.
6. In the Add User or Group panel, type the User logon name of the trusted user (SPPSImpersonator in our example) in the User and group names text entry box, then click OK to register the change.

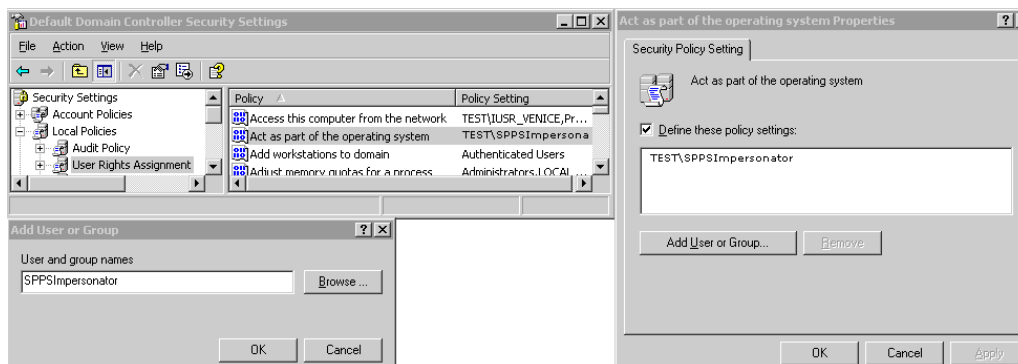
**Figure 59-2 Configuring Rights for the Trusted User in Windows Impersonation**

### 59.6.3 Binding the Trusted User to Your WebGate

You need to bind the trusted user to the 10g WebGate that communicates with Access Manager by supplying the authentication credentials for the trusted user.

The following procedure presumes that you have not yet registered a 10g WebGate with Access Manager. Values in the following procedure are provided as an example only. Your environment will be different.

To bind your trusted user to your WebGate

1. Go to the Oracle Access Management Console.  
For example:  
`http://hostname:port/oamconsole`  
where *hostname* is the fully-qualified DNS name of the computer hosting the Oracle Access Management Console; *port* is the listening *port* configured for the OAM Server; *oamconsole* leads to the Oracle Access Management Console.
2. Click **Application Security** at the top of the window.
3. In the **Launch Pad** tab, click **SSO Agent Registration** in the **Quick Start Wizards** section.
4. Select **WebGate** as the agent type and click **Next**.
5. Set the version to **10g** and enter required details (those with an \*) to register this WebGate.
6. **Protected Resource List:** In this table, enter individual resource URLs to be protected by this OAM Agent, as shown in Table 14–9.
7. **Public Resource List:** In this table, enter individual resource URLs to be public (not protected), as shown in Table 14–9.
8. **Auto Create Policies:** Check to create fresh policies (or clear and use the same host identifier as another WebGate to share policies (Table 14–9)).
9. Click **Apply** to submit the registration.
10. Check the Confirmation window for the location of generated artifacts, then close the window.
11. In the navigation tree, open the Agent page.

12. **SharePoint Requirements:** Enter trusted user credentials in the **Sharepoint Impersonator** fields and click **Apply**.
13. Copy the artifacts as follows (or install the WebGate and then copy these artifacts):
  - a. On the Oracle Access Management Console host, locate the updated OAM Agent ObAccessClient.xml configuration file (and any certificate artifacts). For example:  
`$DOMAIN_HOME/output/$Agent_Name/ObAccessClient.xml`
  - b. On the computer hosting the agent, copy the artifacts. For example  
`10g WebGate/AccessClient: $WebGate_install_dir/oblix/lib/ObAccessClient.xml`
  - c. Proceed to "[Adding an Impersonation Response to an Authorization Policy](#)".

### 59.6.4 Adding an Impersonation Response to an Authorization Policy

An Application Domain and basic policies to protect your SharePoint resources was created when you registered the WebGate with Access Manager. You must add an Authorization Success Action (Response) with a return type of Header, set the name to IMPERSONATE, with the Response value of `$user.userid: "samaccountname"` for a single-domain Active Directory installation or "userPrincipalName" for a multi-domain Active Directory forest.

To add an impersonation response to your Authorization Policy:

1. Click **Application Security** at the top of the Console window.
2. In the **Launch Pad** tab, click **Application Domains** in the **Access Manager** section.
3. Search for the desired domain and open it for editing.
4. Click the **Authorization Policies** tab and open the desired policy for editing.  
  
 "Desired domain" refers to the Application Domain created specifically for impersonation (*Impersonation* for example). "Desired policy" is your default policy created during agent registration. By default, no policy Responses exist until you create them.
5. On the Policy page, click the **Responses** tab, click the **Add (+)** button, and:
  - From the Type list, choose **Header**.
  - In the Name field, enter a unique name for this response: IMPERSONATE
  - In the Value field, enter a value for this Response. For example: `$user.userid`.
6. Click **Add** to save the Response, which is used for the second WebGate request (for authorization).

### 59.6.5 Adding an Impersonation DLL to IIS

You can add an impersonation DLL to IIS.

You can configure IIS Web server for the integration by registering and configuring the IISImpersonationModule.dll across all sites including central administration and web services.

**Alternatively**, if you have multiple Web sites, where some are integrated with Access Manager while others are not, you might want to enable impersonation only for those Web sites that are integrated with Access Manager. To do this, you must configure the Native Module only at those sites that require integration. See:

- [Configuring and Registering ImpersonationModule to IIS.](#)
- [Configuring Site Level Native Modules for Web Sites](#)

#### 59.6.5.1 Configuring and Registering ImpersonationModule to IIS.

You can configure and register ImpersonationModule to IIS

To configure and register ImpersonationModule to IIS

1. Select **Start, Administrative Tools, Internet Information Services (IIS) Manager.**
2. In the left pane of IIS 7, click the **hostname.**
3. In the middle pane, under the IIS header, double click **Modules.**
4. In the right pane, click **Configure Native Modules** and click **Register.**
5. In the window, provide a module Name (for example, *Oracle Impersonation Module*).
6. In the **Path** field, type the full path to IISImpersonationModule.dll.

By default, the path is:

```
WebGate_install_dir\access\oblix\apps\Webgate\bin\IISImpersonation
```

Where *WebGate\_install\_dir* is the directory of your WebGate installation.

---

---

**Note:**

If any spaces exist in the path (for example, *C:\Program Files\Oracle \. . .*) surround the entire string with double quotes (" ").

---

---

7. Click **OK** to register the module.
8. Check the name of the newly created module and click **OK** to apply the module across the Web sites.



Figure 59-3 Registering the Impersonation Module

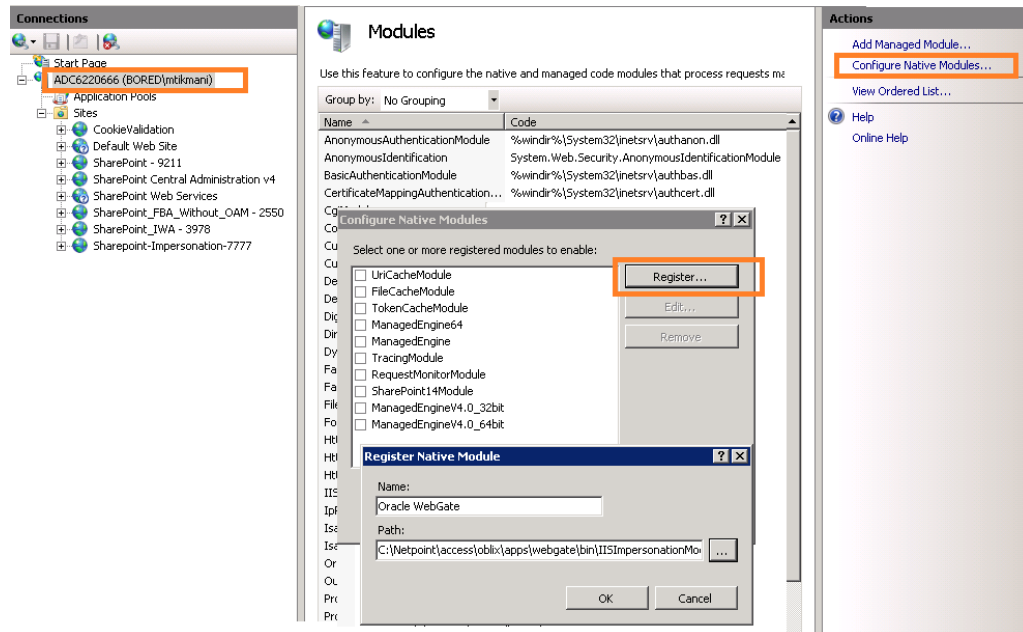

### 59.6.5.2 Configuring Site Level Native Modules for Web Sites

You can configure site level Native Modules for Web sites.

To configure:

1. Click the plus icon (+) icon to left of Sites.
2. Click the site where you want to enable Impersonation.
3. In the Middle pane, under IIS, double click **Modules**.
4. In the right pane, click **Configure Native Modules** and select the Impersonation Module registered earlier.
5. Click **OK**.

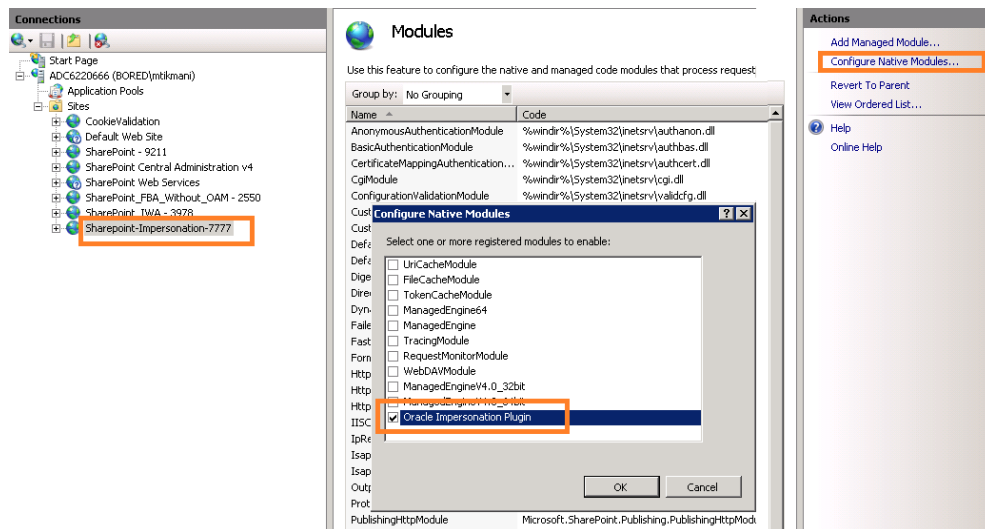

6. Proceed with:

- [Testing Impersonation](#)
- [Completing the SharePoint Server Integration](#)

## 59.6.6 Testing Impersonation

You can test to ensure that impersonation is working properly before you complete the integration.

Following are the ways to test impersonation:

- Outside the SharePoint Server context or test single sign-on, as described in "[Creating an IIS Virtual Site Not Protected by SharePoint Server](#)"
- Using the Event Viewer, as described in "[Testing Impersonation Using the Event Viewer](#)"
- Using a Web page, as described in "[Testing Impersonation using a Web Page](#)"
- Using negative testing as described in "[Negative Testing for Impersonation](#)"

---

---

**See Also:**

"[Completing the SharePoint Server Integration](#)" after confirming impersonation configuration is working properly

---

---

### 59.6.6.1 Creating an IIS Virtual Site Not Protected by SharePoint Server

To test the impersonation feature outside the SharePoint Server context or to test single sign-on, you will need a target Web page on an IIS virtual Web site that is not protected by SharePoint Server.

You create such a virtual Web site by completing the following task.

To create an IIS virtual site not protected by SharePoint Server

1. Select Start, Administrative Tools, Internet Information Services (IIS) Manager.
2. Click the plus icon (+) to the left of the local computer icon on the tree in the left pane.
3. Right-click Web Sites on the tree in the left pane, then navigate to New, Web Site on the menu.
4. Respond to the prompts by the Web site creation wizard.
5. After you create the virtual site, you must protect it with policies in an Application Domain.

### 59.6.6.2 Testing Impersonation Using the Event Viewer

When you complete impersonation testing using the Windows 2003 Event Viewer, you must configure the event viewer before conducting the actual test.

To test impersonation through the Event Viewer:

1. Select **Start Menu, Event Viewer**.



2. Create an IIS virtual site, or use the one you created for the previous task.
3. Place an .asp page or Perl script (such as the sample in the preceding listing) anywhere in the tree of the new virtual site.
4. Point your browser at the page, which should appear, with both AUTH\_USER and IMPERSONATE set to the name of the user making the request.

#### 59.6.6.4 Negative Testing for Impersonation

To conduct negative testing for impersonation, you need to unbind the trusted user from the WebGate.

To unbind the trusted user from your WebGate:

1. In the Oracle Access Management Console, locate the WebGate.
2. Open the desired WebGate registration page and remove the credentials for the trusted user.
3. Click **Apply** to save the change.
4. Restart the IIS server and in a browser window, go to a protected code page (previously accessible to the trusted user).
5. Confirm that you receive an message page should appear. Values for AUTH\_USER and IMPERSONATE are necessary for impersonation credentials to be bound to a WebGate.
6. Restore the trusted user to the WebGate registration page.

## 59.7 Completing the SharePoint Server Integration

You need to complete several procedures to set up an Access Manager with SharePoint Server integration.

Skip this section if you are integrating with SharePoint Server configured with LDAP Membership Provider.

Task overview: Completing the SharePoint Server integration

1. Set up IIS security, as described in "[Configuring IIS Security](#)".
2. Test the integration, as described in "[Testing the SharePoint Server Integration](#)".

### 59.7.1 Configuring IIS Security

Be sure to configure IIS Security before you continue.

To configure IIS Security for the SharePoint Server integration

1. Select **Start, Administrative Tools, Internet Information Services (IIS) Manager**.
2. Click the plus icon (+) to the left of the local computer icon on the tree in the left pane.
3. Click **Web Sites** on the tree in the left pane.
4. In the center pane, double-click on **Authentication** under **IIS**.
5. Ensure that **Anonymous Authentication** is enabled and **Windows Authentication** is disabled.

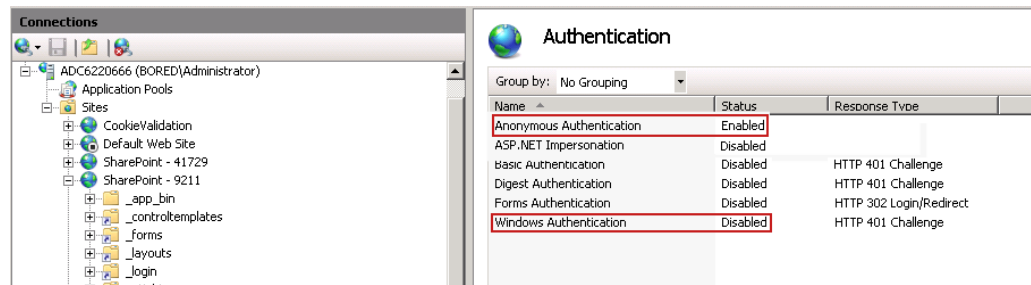
**Figure 59-5 Impersonation Authentication**

## 59.8 Integrating With Microsoft SharePoint Server Configured With LDAP Membership Provider

In this scenario, Access Manager gets integrated with SharePoint Server using SharePoint Security Token Service (STS). This includes the ISAPI WebGate installation on IIS, as well as Access Manager configuration and steps needed to achieve the HeaderVar integration.

---

### Note:

Only 64-bit ISAPI WebGates are supported for this integration.

---

The following overview introduces the tasks that you must perform for this integration, including prerequisites, and where to find the information you need for each task.

Task overview: Integrating with Microsoft SharePoint Server Configured with LDAP Membership Provider

1. Preparing for this integration:
  - a. Install "[Required Microsoft Components](#)", as described.
  - b. Create a SharePoint Web site, as described in "[Creating a New Web Application in Microsoft SharePoint Server](#)".
  - c. Configure the SharePoint site collection, as described in "[Creating a New Site Collection for Microsoft SharePoint Server](#)".
  - d. Configure the created Web site with LDAP directory using Claim-Based Authentication type (which uses the LDAP Membership Provider), as described in your SharePoint documentation.
  - e. Ensure that users who are present in the LDAP directory can log in to the SharePoint Web site and get proper roles.
  - f. Test the configuration to ensure that users who are present in the LDAP directory can log in to the SharePoint Web site and get proper roles, as described in your SharePoint documentation.
2. Perform all tasks described in "[Installing Access Manager for Microsoft SharePoint Server Configured With LDAP Membership Provider](#)".

This task includes installing a 10g WebGate for IIS and configuring a `webGate.dll` for the individual SharePoint Web site.

3. Add an authentication scheme for this integration, as described in "[Configuring an Authentication Scheme for Use With LDAP Membership Provider](#)".
4. Update the Application Domain that protects the SharePoint Web Site, as described in "[Updating the Application Domain Protecting the SharePoint Web Site](#)".
5. In the new Application Domain, create an authorization rule for this integration, as described in "[Creating an Authorization Response for Header Variable SP\\_SSO\\_UID](#)".
6. Perform all steps in "[Creating an Authorization Response for the OAMAuthCookie](#)".
7. Perform all steps in "[Configuring and Deploying OAMCustomMembershipProvider](#)".
8. Synchronize directory servers, if needed, as described in "[Ensuring Directory Servers are Synchronized](#)".
9. Configure single-sign-on for office documents as described in "[Configuring Single Sign-On for Office Documents](#)".
10. Configure single sign-off, as described in "[Configuring Single Sign-off for Microsoft SharePoint Server](#)".
11. Finish by testing your integration to ensure it operates without problem, as described in "[Testing the Integration](#)".

### 59.8.1 About Integrating With Microsoft SharePoint Server Configured With LDAP Membership Provider

The previous scenario, "[Integrating With Microsoft SharePoint Server](#)", describes how to use Windows authentication. In that scenario, authentication and authorization are performed for users residing in Active Directory. Access Manager used Windows impersonation for integration.

For the integration described in this section, support for the LDAP Membership Provider is achieved by using a HeaderVar-based integration. The ISAPI WebGate filter intercepts HTTP requests for Web resources and works with the OAM Server to authenticate the user who made the request. When authentication is successful, WebGate creates an ObSSOCookie and sends it to the user's browser to facilitate single sign-on (SSO). The WebGate also sets SP\_SSO\_UID as a HeaderVar action for this user session. The Oracle Custom Membership provider in SharePoint validates the ObSSOCookie using the HTTP validation method, whereby the Access Manager Custom Membership Provider makes an HTTP/HTTPS request to a protected resource. Access Manager then validates and compares the user login returned on Authorization success with SP\_SSO\_UID.

---

---

**See Also:**

"[Introduction to Integrating With the SharePoint Server](#)" for a look at processing differences between this integration and the other integrations described in this chapter.

---

---

**Requirements:** This integration requires that Microsoft SharePoint Server:

- Must be integrated with the LDAP Membership Provider. Must not use Windows authentication
- Must not have `IISImpersonationModule.dll` configured at the Web site using Claim Based Authentication

---

**See Also:**

["Integration Requirements"](#)

---

## 59.8.2 Installing Access Manager for Microsoft SharePoint Server Configured With LDAP Membership Provider

You can prepare your installation for integration with Microsoft SharePoint Server Configured with LDAP Membership Provider.

### Prerequisites

Perform Step 1 of the previous ["About Integrating With Microsoft SharePoint Server Configured With LDAP Membership Provider"](#).

To prepare your deployment for integration that includes LDAP Membership Provider

1. Install Oracle Identity Management and Access Manager.
2. Provision and install an ISAPI WebGate.
3. Configure `Webgate.dll` at the SharePoint Web site that you want to protect. For example:
  - a. Start the Internet Information Services (IIS) Manager: Click Start, Programs, Administrative Tools, Internet Information Services (IIS) Manager
  - b. Under Web Sites, double click the name of the SharePoint Web site to protect.
  - c. In the Middle pane, double click ISAPI Filters and click Add in the right pane.
  - d. Enter the filter name as **Oracle WebGate**.
  - e. Enter the following path to the `Webgate.dll` file.  
`WebGate_install_dir/access/oblix/apps/Webgate/bin/Webgate.dll`
  - f. Save and apply these changes.
  - g. Double click **Authentication** in the middle pane.
  - h. Verify that the following Internet Information Services settings are correct: **Anonymous Authentication** and **Forms Authentication** is enabled, and **Windows Authentication** is disabled.

---

**Note:**

For Claim-based Authentication to work with Access Manager, Windows Authentication for the SharePoint Site must be disabled.

---

- i. **Save** and **Apply** these changes.

4. Go to the Web sites level to protect and create an /access application that points to the newly installed *WebGate\_install\_dir*. For instance:
  - a. Under Web Sites, right-click the name of the Web site to be protected.
  - b. Select Add application named with the alias "access" that points to the appropriate *WebGate\_install\_dir\access*.
  - c. Under Access Permissions, check **Read**, **Run Scripts**, and **Execute**.
  - d. **Save** and **apply** these changes.
5. Proceed to "[Configuring an Authentication Scheme for Use With LDAP Membership Provider](#)".

### 59.8.3 Configuring an Authentication Scheme for Use With LDAP Membership Provider

When your integration includes the LDAP Membership Provider, only three Access Manager authentication methods are supported.

To configure an authentication scheme for SharePoint with LDAP Membership Provider:

1. In the Oracle Access Management Console, click **Application Security** at the top of the window.
2. In the **Launch Pad** tab, select **Create Authentication Scheme** from the **Create (+)** drop-down menu the **Access Manager** section.
3. On the Authentication Scheme page, fill in the:
  - Name: Enter a unique name for this scheme. For example: *SharePoint w/LDAP-MP*
  - Description: Optional
4. Authentication Level: Choose a level of security for the scheme.
5. Choose a Challenge Method:
  - Basic Authentication for SharePoint Web site root (/)**
  - Form Authentication with Challenge Redirect for SharePoint Web site root (/)**
  - Client Certificate Authentication for SharePoint Web site root (/)**
6. Challenge Redirect: Enter your challenge redirect value, if required.
7. Choose an Authentication Module from those listed.
8. Challenge Parameters: Enter your challenge parameter values, if required.
9. Challenge URL: The URL the credential collector will redirect to for credential collection.
10. Click **Apply** to submit the new scheme, review details in the Confirmation window.
11. **Optional:** Click the **Set as Default** button to automatically use this with new Application Domains, then close the Confirmation window.
12. In the navigation tree, confirm the new scheme is listed, and then close the page.



13. Proceed with "[Updating the Application Domain Protecting the SharePoint Web Site](#)".

---



---

**Note:**

If the SharePoint resource is protected with an Access Manager client-cert authentication scheme, you might need to add to the PATH environment variable `C:\Program Files\Microsoft Office Servers\14.0\Bin;C:\Program Files\Common Files\Microsoft Shared\Web Server Extensions\14\BIN`.

---



---

## 59.8.4 Updating the Application Domain Protecting the SharePoint Web Site

The Application Domain was created when you provisioned the IIS WebGate to protect the Microsoft SharePoint Server Web site for the integration scenario with LDAP Membership Provider.

Within an Application Domain, resource definitions exist as a flat collection of objects. Each resource is defined as a specific type, and the URL prefix that identifies a document or entity stored on a server and available for access by a large audience. The location is specified using an existing shared Host Identifier.

---



---

**Note:**

For this integration, leave empty the URL Prefix. Do not enter a region to be appended to the URL prefix.

---



---

You need to use the authentication scheme that you created earlier. To validate the ObSSOCookie, you must create another policy for a resource protected by a WebGate; for example: `/ValidateCookie`. This resource should be deployed on a Web server protected by a WebGate and you should be able to access it after providing correct Access Manager credentials: `http(s)://host:port/ValidateCookie`

This example uses *SharePoint w/LDAP-MP* as the Application Domain name. Your environment will be different.

---



---

**Note:**

Step 4 includes an alternative Authentication Scheme to protect the SharePoint Web site with a Form authentication scheme.

---



---

To update the Application Domain protecting the root SharePoint Web site

1. From the Oracle Access Management Console, open the *SharePoint w/LDAP-MP* Application Domain.
2. Open the **Resources** tab, then click the **New Resource** button.
3. On the Resource Definition page, select or enter your details for a single resource and click Apply:

Type: http

Description (optional): *Protecting SharePoint Website*

Host Identifier: Select the host identifier that you added earlier.

Resource URL: Enter */ValidateCookie*.

Protection Level: Protected

Authentication Policy (*if level is Protected*)

Authorization Policy (*if level is Protected and Authentication Policy is chosen*)

4. In the Protected Resource Policy for Authentication, add a defined resource:
  - Click the **Resources** tab on the Authentication Policy page.
  - Click the **Add** button on the **Resources** tab.
  - Locate and select the desired resource definition, then click **Add Selected**.
  - Click **Apply** to add the resources.
  - Repeat to add more resources.
5. Click the **Responses** tab, then click its **Add** button and:
  - In the **Name** field, enter a unique name for this response (*SP\_SSO\_UID*).
  - From the **Type** list, choose **Header**.
  - In the **Value** field, enter a value for this response. For example: *\$user.userid*.
  - Click **Apply**.
6. **Add a Policy:** Add a policy for a resource used with the HTTP validation method, If selected.
7. Before you enable this Application Domain, proceed to "[Creating an Authorization Response for Header Variable SP\\_SSO\\_UID](#) "

### 59.8.5 Creating an Authorization Response for Header Variable SP\_SSO\_UID

You can add an Authorization Response for the integration configured with LDAP Membership Provider.

For this integration, you add the following Header Variable to the Application Domain as Responses for Authorization success:

```
Type = Header
Name = SP_SSO_UID
Return Attribute = $user.userid
```

In this case:

- The Return Attribute is the login attribute used in Login
- This authorization rule protects the root SharePoint Web site *"/* "

To create an authorization response for SharePoint with LDAP Membership Provider

1. From the Oracle Access Management Console, open the *SharePoint w/LDAP-MP* Authorization Policy: *ProtectedResourcePolicy*.
2. Click the **Authorization Policy Responses** tab, then click its **Add** button:

- In the **Name** field, enter a unique name for this response (*SharePoint w/LDAP-MP*).
  - From the **Type** list, choose **Header**.
  - In the **Value** field, enter a value for this response. For example: *\$user.userid*.
  - Click **Apply**.
  - Repeat as needed.
3. Proceed to "[Creating an Authorization Response for the OAMAuthCookie](#)".

### 59.8.6 Creating an Authorization Response for the OAMAuthCookie

You can add the Header Variable named `OAMAuthCookie` to the Application Domain as Responses under Authorization success.

The Header Variable:

```
Type = Cookie
Name = OAMAuthCookie
Return Attribute = $user.userid
```

To create a Application Domain to protect the validation URL

1. From the Oracle Access Management Console, open the *SharePoint w/LDAP-MP* Authorization Policy: *Protected Resource Policy*:
2. Click the **Responses** tab, then click its **Add** button and:

Redirection URL: Not required for this integration

Return

```
Type = Cookie
Name = OAMAuthCookie
Return Attribute = $user.userid
```

- In the **Name** field, enter a unique name for this response (*OAMAuthCookie*).
  - From the **Type** list, choose **Cookie**.
  - In the **Value** field, enter a value for this response. For example: *\$user.userid*.
  - Click **Apply** to submit the response, then close the confirmation window.
  - Repeat as needed.
3. Proceed to "[Configuring and Deploying OAMCustomMembershipProvider](#)".

### 59.8.7 Configuring and Deploying OAMCustomMembershipProvider

You can use the Access Manager Authentication Module to authenticate and authorize the user

You can specify a default login page bundled in this file:

```
WebGate_install_dir\access\oblix\apps\Webgate\
OAMCustomMembershipProvider\samples\Sample.Default.aspx
```

To configure SharePoint to use OAM authentication Module

1. Go to the physical location of the SharePoint Web site directory. For example:

```
C:\Inetpub\wwwroot\wss\VirtualDirectories\SharePoint website Name
```

2. From the folder\_forms, copy the file Default.aspx as Default.Orig.aspx.
3. Open Default.aspx, search for </asp:login>, add the following after the line, and then save the file:

```
<asp:HiddenField EnableViewState="false" ID="loginTracker" runat="server"
Value="autoLogin" />

<%bool autoLogin = loginTracker.Value == "autoLogin";%>

<script runat="server">
 void Page_Load()
 {

 signInControl.LoginError += new EventHandler(OnLoginError);
 NameValueCollection headers = Request.ServerVariables;
 NameValueCollection queryString = Request.QueryString;
 string loginasanotheruser = queryString.Get("loginasanotheruser");
 string username = Request.ServerVariables.Get("HTTP_SP_SSO_UID");
 HttpCookie ObSSOCookie = Request.Cookies["ObSSOCookie"];
 bool isOAMCredsPresent = username != null && username.Length > 0 &&
ObSSOCookie != null && ObSSOCookie.Value != null;
 bool signInAsDifferentUser = loginasanotheruser != null &&
loginasanotheruser.Contains("true");

 if (isOAMCredsPresent)
 {

 //Handling For UTF-8 Encoding in HeaderName
 if (username.StartsWith("=?UTF-8?B?") && username.EndsWith("?="))
 {
 username = username.Substring("=?UTF-8?B?".Length,
username.Length - 12);
 byte[] decodedBytes = Convert.FromBase64String(username);
 username = Encoding.UTF8.GetString(decodedBytes);
 }
 if (isOAMCredsPresent && loginTracker.Value == "autoLogin" && !
signInAsDifferentUser)
 {
 bool
status=Microsoft.SharePoint.IdentityModel.SPClaimsUtility.AuthenticateFormsUser(ne
w Uri(SPContext.Current.Site.Url),username,"ObSSOCookie:"+ObSSOCookie.Value);
 if(status){
 if (Context.Request.QueryString.Keys.Count > 1)
 {

Response.Redirect(Context.Request.QueryString["Source"].ToString());
 }
 else

Response.Redirect(Context.Request.QueryString["ReturnUrl"].ToString());
 }
 else{
 loginTracker.Value =
 }
 }
 }
 }
}
```

```

 }
 else
 {

 // DO NOTHING
 }
}
void OnLoginError(object sender, EventArgs e)
{
 loginTracker.Value = "";
}
</
script>

```

4. Go to IIS Manager and click the Plus icon (+) before **Sites**.
5. Click on the plus icon (+) before **SharePoint Web Services**.
6. Right -click **SecurityTokenServiceApplication**, then click **Explore**.
7. Create a backup copy of `Web.config` as `Web.config.ORIG`, then open `Web.config`.
8. In the membership provider entries for enabling the LDAP membership provider go to `<membership>`, `<providers>`, type, and then modify the type value as follows:

```

type = "Oracle.CustomMembershipProvider, OAMCustomMembershipProvider,
Version=1.0.0.0, Culture=neutral, PublicKeyToken=52e6b93f6f0427a1

```

9. Add the following attribute at the end of the entry in Step 8  
`ValidationMode="OAMHttp"` to indicate the `ObSSOCookie` validation method.

```

<add name="membership"
 type = "Oracle.CustomMembershipProvider,
OAMCustomMembershipProvider, Version=1.0.0.0, Culture=neutral,
PublicKeyToken=52e6b93f6f0427a1"
 server="HOST1.COM"
 port="389"
 useSSL="false"
 userDNAttribute="distinguishedName"
 userNameAttribute="sAMAccountName"
 userContainer="cn=users,dc=bored,dc=com"
 userObjectClass="person"
 userFilter="(& (ObjectClass=person))"
 scope="Subtree"
 otherRequiredUserAttributes="sn,givenname,cn"
 ValidationURL="http(s)://host:port/ValidateCookie.html"
 OAMAuthUser="OAMAuthCookie"
 ValidationMode="OAMHttp"
/>

```

---

**Note:**

The resource configured for `ValidationURL` must be present on the Web server. Also, the value of the `OAMAuthUser` parameter should be configured as the authorization return action as described in Step 6.

---

10. Save the file.

11. Using command prompt go to the following directory:

```
C:\Program Files\Microsoft SDKs\Windows\v6.0A\Bin\gacutil.exe
```

12. Type:

```
gacutil -l OAMCustomMembershipProvider
```

13. Confirm that no results are returned.

14. Type the following.

```
gacutil -i <Webgate_install_dir>\access\oblix\apps\Webgate
\OAMCustomMembershipProvider\OAMCustomMembershipProvider.dll
```

15. Type:

```
gacutil -l OAMCustomMembershipProvider
```

16. Confirm that one result is returned.

17. Restart the SharePoint Web site.

18. Proceed as follows:

- [Enabling Logging for CustomMemberShipProvider](#)
- [Ensuring Directory Servers are Synchronized](#)
- [Configuring Single Sign-off for Microsoft SharePoint Server](#)

### 59.8.8 Enabling Logging for CustomMemberShipProvider

If you want to enable logs for the Oracle Custom Membership Provider, you must configure the `DebugFile` parameter in the configuration file for the Oracle Custom Membership Provider.

For example: a sample entry for the `DebugFile=Location_of_logs_file`:

```
type = "Oracle.CustomMembershipProvider, OAMCustomMembershipProvider,
Version=1.0.0.0, Culture=neutral, PublicKeyToken=52e6b93f6f0427a1" DebugFile="c:
\Debug.txt"
```

### 59.8.9 Ensuring Directory Servers are Synchronized

Users in the directory server configured for Access Manager should be synchronized with the directory server used by SharePoint if these are different.

This is the same task that you perform for other integration scenarios in this chapter. When your SharePoint integration includes an LDAP Membership Provider, however, you can use a directory server that supports LDAP commands.

---

**See Also:**

["Synchronizing User Profiles Between Directories"](#)

---

### 59.8.10 Testing the Integration

This is similar to the task you perform for other integration scenarios in this chapter. There are no differences when configured with LDAP Membership Provider.

---

**See Also:**

["Testing the SharePoint Server Integration"](#)

---

## 59.9 Configuring Single Sign-On for Office Documents

Single sign-on for Office documents can be achieved by setting a persistent cookie in the authentication scheme.

To do this using OAM 11g, you need to set `ssoCookie=max-age` in the authentication scheme. This creates a persistent cookie which lasts for more than one session.

---

**Note:**

For integration based on Windows Native Authentication, you do not need to set the persistent cookie parameter.

---

1. Log in to the Oracle Access Management Console.
2. Find the Authentication Scheme being used and open the page.
3. In the **Challenge Parameter**, add:

```
ssoCookie=max-age=1000000
```

Where, `time-in-seconds` represents the time interval when the cookie expires. For example, `ssoCookie=max-age=3600` sets the cookie to expire in 1 hour (3600 seconds).

4. Save the change.
5. Configure centralized logout for the 10g or 11g WebGate.

### 59.10 Configuring Single Sign-off for Microsoft SharePoint Server

Manual Logout occurs when the user clicks the Logout button from SharePoint Server. You can configure the SharePoint Server logout URL in Access Manager so that when a user clicks the Logout button from SharePoint Server site, Access Manager logout is also triggered.

Closing the browser window after sign-off is always recommended, for security. Cookie time-out occurs when the overall user session is controlled by `ObSSOCookie`. Consider the following use-case:

- FedAuth cookie time-out and ObSSOCookie is still valid: The user won't be challenged again because the ObSSOCookie is present. A new FedAuth cookie is generated (using the same flow described earlier).
- ObSSOCookie time-out and FedAuth Cookie is still valid: Since each request is intercepted by the WebGate, the user is challenged for credentials again.

Access Manager provides single logout (also known as global or centralized log out) for user sessions. With Access Manager, single logout refers to the process of terminating an active user session.

This topic describes how to configure single sign-off for integration with SharePoint. Single sign-off kills the user session.

- [Configuring a Custom Logout URL in SharePoint Server](#)
- [Configuring Logout in SharePoint Server With Impersonation](#)

### 59.10.1 Configuring a Custom Logout URL in SharePoint Server

You can configure a custom logout URL in SharePoint Server.

To configure:

1. From the generated artifacts for WebGate, add `logout.html` to the SharePoint Server Site
2. Locate `C:\Program Files\Common Files\Microsoft Shared\Web Server Extensions\14\TEMPLATE\CONTROLTEMPLATES`.
3. In `\CONTROLTEMPLATES`, change the `welcome.ascx` by adding the following tag. For example:

```
<SharePoint:MenuItemTemplate runat="server" id="ID_OverrideLogout" Text="Custom Logout"
 ClientOnClickNavigateUrl="/logout.html?end_url=_layouts/SignOut.aspx"
 Description="My Custom Logout"
 MenuGroupId="200"
 Sequence="100"
 UseShortId="true" />
```

4. Click Save.
5. Protect the two URLs `/_layouts/SignOut.aspx` and `/_layouts/closeConnection.aspx` in an Application Domain using Anonymous authentication.
6. Proceed to [Configuring Logout in SharePoint Server With Impersonation](#).

### 59.10.2 Configuring Logout in SharePoint Server With Impersonation

You can configure logout in SharePoint server with Impersonation. If you do not have Impersonation configured, this procedure can be skipped.

To configure:

1. Copy `signout.aspx` from `C:\Program Files\Common Files\Microsoft Shared\Web Server Extensions\14\TEMPLATE\LAYOUTS` to `MySignout.aspx` in the same path.



2. In `MySignout.aspx`, below (`<asp:content contentplaceholderid="PlaceHolderAdditionalPageHead" runat="server">`) add the following script details:
 

```
<script runat="server">
private void Page_Load(object sender, System.EventArgs e){
 Response.Status = "302 Moved Temporarily";
 Response.AddHeader("Location", "/logout.html?end_url=/_layouts/SignOut.aspx");
}
</script>
```
3. Save.
4. Use this URL `_layouts/MySignout.aspx` as custom logout URL for SharePoint Server in the case of Impersonation.
5. Proceed with "[Testing Your Integration](#)".

## 59.11 Setting Up Access Manager and Windows Native Authentication

This section provides the following topics:

- [Setting Up Access Manager WNA](#)
- [Setting Up WNA With SharePoint Server](#)
- [Installing Access Manager for WNA and SharePoint Server](#)
- [Testing Your WNA Implementation](#)

### 59.11.1 Setting Up Access Manager WNA

Configure Access Manager to use Windows Native Authentication.

### 59.11.2 Setting Up WNA With SharePoint Server

The following overview outlines the tasks that must be performed to set up WNA with Access Manager and the SharePoint Server.

Task overview: Setting up WNA with SharePoint Server

1. Complete the following prerequisite tasks:
  - Perform tasks in "[Required Microsoft Components](#)".
  - Create a SharePoint Web site, as described in "[Creating a New Web Application in Microsoft SharePoint Server](#)".
  - Configure the SharePoint site collection, as described in "[Creating a New Site Collection for Microsoft SharePoint Server](#)".
  - Test the configuration to ensure that users who are present in the directory server can log in to the SharePoint Web site and get proper roles, as described in your SharePoint documentation.
2. Install Access Manager as described in "[Installing Access Manager for WNA and SharePoint Server](#)".

This step includes installing the WebGate for IIS and configuring `Webgate.dll` for the individual SharePoint Web site.

3. Configure the Active Directory authentication provider, as follows:
  - a. Login to the WebLogic Console.
  - b. Go to Security Realm and click the realm being used.
  - c. Go to the Provider tab provider, click New.
  - d. Enter the provider name, select the Type **ActiveDirectoryAuthenticator**, click OK.
  - e. Select the newly created Provider, change Control Flag to Sufficient, and Save.
  - f. Go to Provider Specific tab, enter details for your Active Directory, and save these.
4. Perform "[Testing Your WNA Implementation](#)".

### 59.11.3 Installing Access Manager for WNA and SharePoint Server

You perform this task after you perform all prerequisites described in step 1 of the "[Setting Up WNA With SharePoint Server](#)". Installing most Access Manager components for this integration scenario is the same as for any other situation.

Installing the IIS WebGate is similar to installing any other WebGate. The WebGate should be installed with the IIS v7 Web server; later it can be configured at the specific SharePoint Web site level to be protected. For IIS, the WebGate must be configured at the "web sites" level. For Microsoft SharePoint Server, you must configure the WebGate for the specific SharePoint Web site level to be protected.

To install Access Manager for WNA and SharePoint Server

1. Install Access Manager as described in the *Oracle Fusion Middleware Installation Guide for Oracle Identity and Access Management*.
2. Install the ISAPI WebGate as follows:
  - Installing WebGates
  - Installing Web components for the IIS Web server

Next, you configure `webgate.dll` at the SharePoint Web site that you want to protect. Configuring `webgate.dll` at the "Website level" protects all Web sites on the IIS Web server. However, configuring `webgate.dll` at the "SharePoint Website" protects only the expected Web site.
3. Configure `webgate.dll` at the SharePoint Web site that you want to protect. For example:
  - a. Start the Internet Information Services (IIS) Manager: Click **Start, Programs, Administrative Tools, Internet Information Services (IIS) Manager**.
  - b. Select the hostname from the **Connections** pane.
  - c. From the host name Home pane, double-click **ISAPI Filters**, look for any `webgate.dll`; if it is present, select it and click **Remove** from the **Action** pane.

- d. In the **Connection** pane, under Sites, click the name of the Web Site for which you want to configure a WebGate filter.
  - e. In the **Home** pane, double-click **ISAPI Filters**.
  - f. In the **Actions** pane, click **Add...**
  - g. In the **Filter** name text box of the **Add ISAPI Filter** dialog box, type WebGate as the name of the ISAPI filter.
  - h. In the **Executable** box, type the file system path of the WebGate ISAPI filter file or click the ellipsis button (...) to go to the folder that contains the `Webgate.dll` ISAPI filter file, and then click **OK**.  
`WebGate_install_dir\access\oblix\apps\Webgate\bin\Webgate.dll`
4. Creating a Virtual Directory
    - a. Expand the **Sites** pane and select the Web Site for which you just configured the ISAPI filter (`Webgate.dll`).
    - b. On the **Action** pane, click **View Virtual Directories** and then select **Add Virtual Directory**.
    - c. In the **Alias** field, specify `access` and the physical path to the WebGate `\access` folder (or click the ellipsis button (...), go to the `\access` folder, then click **OK**).  
`WebGate_install_dir\access\`
  5. Set permissions on the Virtual Directory:
    - a. Select the "access" virtual directory created in Step 3.
    - b. From the access Home pane, double click **Handler Mappings**; from the **Action** pane, select **Edit Feature Permissions...**
    - c. Select **Read**, **Script**, and **Execute**, then click **OK**
  6. Configure Access Manager to use Windows Native Authentication.
  7. Configure Microsoft SharePoint Server Authentication to Classic Mode Authentication while creating a new Web Application in Microsoft SharePoint. In the Authentication Provider section, select `Negotiate(Kerberos)`.
  8. Go to IIS newly created SharePoint site and:
    - a. Open **Authentication, Windows Authentication, Advance Settings**.
    - b. Select **Enable Kernel mode authentication**.
    - c. Select providers, delete NTLM provider.
    - d. Add **Negotiate:Kerberos** and move it to the top level.
    - e. Restart IIS.
  9. Proceed to "[Testing Your WNA Implementation](#)".

### 59.11.4 Testing Your WNA Implementation

Use the following steps to confirm your WNA implementation is working properly.

To test your WNA implementation

1. Log in to the machine as the Windows domain user (or AD user or AD user account).

The login account must also be a user of Access Manager.

2. Enter the URL of the protected resource.

## 59.12 Synchronizing User Profiles Between Directories

You need to synchronize user profiles between the SharePoint Server directory and the Access Manager directory.

Unless explicitly stated, this task should be performed for all integration scenarios in this chapter.

---

---

**Note:**

When your integration includes LDAP Membership Provider, you can use any directory server that supports LDAP commands.

---

---

To synchronize:

- **Uploading user data**—If your Access Manager installation is configured for any directory server other than SharePoint Active Directory, you must load the user profiles that reside on the other directory server to SharePoint Active Directory.

Proceed to "[Testing Your Integration](#)"

## 59.13 Testing Your Integration

After you complete the tasks to enable integration, you should test to verify that integration is working.

This section contains the following topics:

- [Testing the SharePoint Server Integration](#)
- [Testing Single Sign-On for the SharePoint Server Integration](#)

### 59.13.1 Testing the SharePoint Server Integration

You can verify that a user can access SharePoint Server resources through Access Manager authentication and SharePoint Server authorization.

To test your SharePoint Server integration:

1. Navigate to any SharePoint Server Web page using your browser.

You are challenged for your credentials.

2. Log in by supplying the necessary credentials.
3. Verify that the page you requested is visible.
4. **Optional:** Check the Event Viewer to confirm that the access request was successful.

## 59.13.2 Testing Single Sign-On for the SharePoint Server Integration

You can also test single sign-on by demonstrating that a user who has just supplied credentials and accessed an SharePoint Server resource can (before the ObSSOCookie expires) access a non-SharePoint Server resource without having to supply credentials a second time.

For example, use a resource defined in the Policy Manager. When single sign-on is working, you should be granted access to the page without having to supply credentials a second time.

To test single sign-on for your SharePoint Server integration:

1. Create and protect a new virtual site with a Application Domain (or use one you have already created).
2. Place a Web page anywhere in the tree of this virtual site.
3. Using a browser, navigate to the page in the new virtual site.

If you have already passed authentication, you should be granted access to the page without having to supply credentials a second time.

## 59.14 Troubleshooting

- [Internet Explorer File Downloads Over SSL Might Not Work](#)

### 59.14.1 Internet Explorer File Downloads Over SSL Might Not Work

The issue may occur if the server sends a `Cache-control: no-store` header or sends a `Cache-control: no-cache` header. The WebGate provides configuration parameters to control setting these headers.

Following are the parameters and their default value:

`CachePragmaHeader no-cache`

`CacheControlHeader no-cache`

You can modify the WebGate configuration not to set these headers at all (the values for these parameters would be kept blank). By this, it would mean that Access Manager will not control the caching behavior.



---

# Integrating Access Manager with Outlook Web Application

In a Windows environment, after a user authenticates, the authenticating application can impersonate that user's identity. The primary purpose of impersonation is to trigger access checks against a client's identity.

This chapter focuses on how to enable impersonation in Access Manager to override impersonation enabled with IIS. The following topics are provided:

- [What is New in This Release?](#)
- [Introduction to Integration with Outlook Web Application](#)
- [Enabling Impersonation With a Header Variable](#)
- [Setting Up Impersonation for Outlook Web Application \(OWA\)](#)
- [Setting Up Access Manager WNA for Outlook Web Application](#)

## 60.1 What is New in This Release?

Support for integration between Access Manager and Outlook Web Application (OWA) 2010.

This chapter illustrates:

- [Enabling Impersonation With a Header Variable](#)
- [Setting Up Impersonation for Outlook Web Application \(OWA\)](#)
- [Setting Up Access Manager WNA for Outlook Web Application](#)

## 60.2 Introduction to Integration with Outlook Web Application

This section provides the following information to introduce the integration described in this chapter:

- [About Impersonation Provided by Microsoft Windows](#)
- [Access Manager 11g Support for Windows Impersonation](#)
- [Single Sign-On for Authenticated Access Manager Users into Exchange](#)
- [Confirming Requirements](#)

### 60.2.1 About Impersonation Provided by Microsoft Windows

Impersonation ensures that the server can or cannot do exactly what the client can or cannot do. When running in a client's security context, a service can to an extent

become a client. After the user authenticates, the service can take on that user's identity through impersonation.

One of the service's threads uses an access token, known as an impersonation token, to obtain access to objects the client can access. The access token is a protected object that represents the client's credentials. The impersonation token identifies the client, the client's groups, and the client's privileges. The information in the token is used during access checks when the thread requests access to resources on the client's behalf. When the server is impersonating the client, any operations performed by the server are performed using the client's credentials.

Impersonation ensures that the server can or cannot do exactly what the client can or cannot do. Access to resources can be restricted or expanded, depending on what the client has permission to do. Impersonation requires the participation of both the client and the server. The client must indicate its willingness to let the server use its identity, and the server must explicitly assume the client's identity programmatically.

When impersonation concludes, the thread uses the primary token to operate using the service's own security context rather than the client's. The primary token describes the security context of the user account associated with the process (the person who started the application).

Services run under their own accounts and act as users in their own right. For example, system services that are installed with the operating system run under the Local System account. You can configure other services to run under the Local System account, or separate accounts on the local system or in Active Directory.

The IIS Web server provides impersonation capabilities. However, the OAM Server overrides IIS authentication, authorization, and impersonation functions. For more information, see "[Access Manager 11g Support for Windows Impersonation](#)" in the next section.

## 60.2.2 Access Manager 11g Support for Windows Impersonation

You can enable support for Windows impersonation to provide additional access control for protected applications.

You bind a trusted user to a Webgate and protect the application with a application domain that includes an impersonation action in the authorization rule. During the authorization process, the protected application creates an impersonation token.

For more information, see, [Enabling Impersonation With a Header Variable](#) It provides prerequisites and details about implementing impersonation using header variables.

## 60.2.3 Single Sign-On for Authenticated Access Manager Users into Exchange

Single Sign-On for Authenticated Access Manager Users into Exchange is also supported using the Windows Impersonation feature.

Outlook Web Access (OWA) provides Web access to Exchange mail services and may be configured on either of the following:

- An IIS Web server that does not reside on the same host as the Exchange server, which is also known as a front-end server
- An IIS Web server running on the same host as the Exchange server, which is also known as the back-end server



In a front-end server configuration, the front-end OWA server authenticates the user, determines the back-end Exchange server that hosts the user's mailbox, then proxies the request to the appropriate back-end Exchange server. No additional credential information is passed. No delegation is performed. Setting up Impersonation on the back-end Exchange server ensures that the Exchange server does not need to request credentials before granting access.

For more information, see [Setting Up Impersonation for Outlook Web Application \(OWA\)](#)

## 60.2.4 Confirming Requirements

Here is an example that illustrates setting up the impersonation feature for the OAM Server to Microsoft Exchange Server 2013 integration.

The principles are the same regardless of your application. Any references to specific versions and platforms in this chapter are for demonstration purposes. For the latest Access Manager certification information, see Oracle Technology Network at:

<http://www.oracle.com/technetwork/middleware/ias/downloads/fusion-certification-100350.html>

## 60.3 Enabling Impersonation With a Header Variable

Enabling impersonation with a header variable involves completing the procedures in the following sections.

1. [Reviewing all Requirements for Impersonation with a Header Variable](#)
2. [Creating an Impersonator as a Trusted User](#)
3. [Assigning Rights to the Trusted User](#)
4. [Binding the Trusted User to Your WebGate](#)
5. [Adding an Impersonation Response to An Application Domain](#)
6. [Adding an Impersonation DLL to IIS](#)
7. [Testing Impersonation](#)

---

---

**See Also:**

["Setting Up Impersonation for Outlook Web Application \(OWA\)".](#)

---

---

### 60.3.1 Requirements for Impersonation with a Header Variable

Prepare the environment and confirm that it is operating properly before implementing Windows impersonation with the OAM Server.

[Table 60-1](#) identifies the Access Manager platform requirements when you enable impersonation using a header variable.

**Table 60-1 Requirements for Impersonation with a Header Variable**

Item	Platform
11g WebGate (and Impersonation dll)	Microsoft IIS 7.x and Windows Server 2008 and 2013
Impersonation dll	<i>Webgate_install_dir</i> \webgate\iis\lib \IISImpersonationModule.dll <ul style="list-style-type: none"> <li>• Must be installed as an IIS Module.</li> <li>• May be installed at any level of the Web site tree.</li> </ul>
Kerberos Key Distribution Center (KDC) and Active Directory	Windows Server 2008 and 2013
Client and Server machines	<ul style="list-style-type: none"> <li>• Both must be in the same Windows Server 2008 domain with a trust relationship.</li> <li>• A bi-directional trust path is required because the service, acting on the client's behalf, must request tickets from the client's domain.</li> </ul>
Security context	Must have <i>Act as operating system</i> privileges. Note: IWAM_Machine is not recommended
Mutual authentication is required	Mutual authentication is supported remotely.

### 60.3.2 Creating an Impersonator as a Trusted User

Whether you enable impersonation using a HeaderVar or user profile attribute, the return value must be a trusted user in Active Directory. This special user should not be used for anything other than impersonation.

The example in the following procedure uses *SPPSImpersonator* as the New Object - User. With *OWAImpersonator* as *SPPSImpersonator* denotes SharePoint impersonation specifically. Your environment will be different.

1. Perform the steps for your environment on the computer hosting your Microsoft Exchange Server 2013 installation:
  - Windows 2008 or 2012: Select Start, Programs, Administrative tools, Active Directory Users and Computers.
2. In the Active Directory Users and Computers window, right-click Users on the tree in the left pane, then select New; User.
3. In the First name field of the pane entitled New Object - User, enter an easy-to-remember name such as *SPPSImpersonator*.
4. Copy this same string to the User logon name field, then click Next.
5. In succeeding panels, you are asked to choose a password and then retype it to confirm.

**Note:**

Oracle recommends that you choose a very complex password, because your trusted user is being given very powerful permissions. Also, be sure to check the box marked Password Never Expires. Since the impersonation module should be the only entity that ever sees the trusted user account, it would be very difficult for an outside agency to discover that the password has expired.

**Figure 60-1** Setting up a Trusted User Account for Windows Impersonation

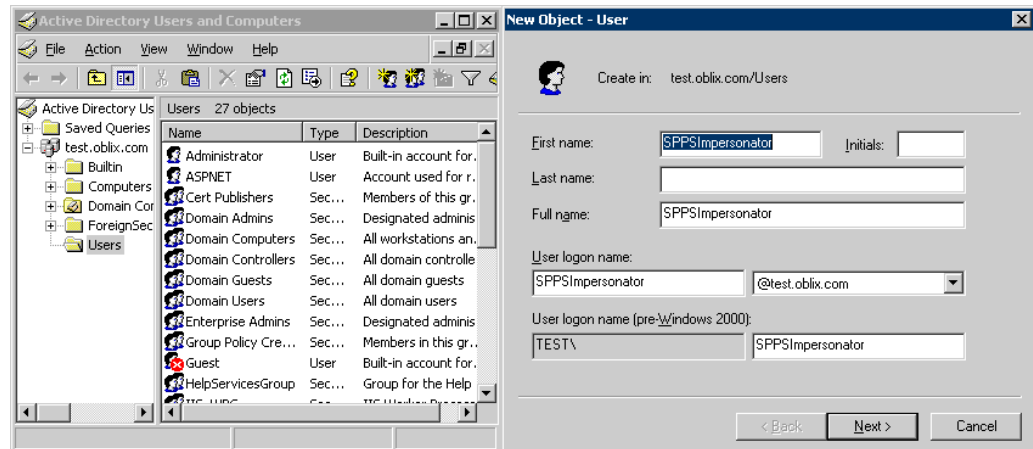

### 60.3.3 Assigning Rights to the Trusted User

You can give the trusted user the right to act as part of the operating system.

To assign rights to the trusted user:

1. Perform the appropriate step for your environment:

- Windows 2008: Select Start > Programs > Administrative tools > Local Security Policy.

You must modify the group policy object that applies to the computer where the Webgate is installed.

2. On the tree in the left pane, click the plus icon (+) next to Local Policies.
3. Click User Rights Assignment on the tree in the left pane.
4. Double-click "Act as part of the operating system" in the right pane.
5. Click Add User or Group.
6. In the Add User or Group panel, type the User logon name of the trusted user (Microsoft Exchange Server 2010 Impersonator in our example) in the User and group names text entry box, then click OK to register the change.

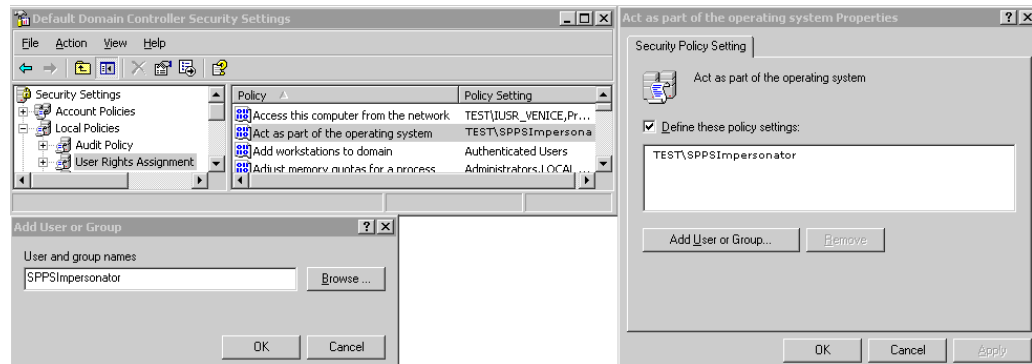
**Figure 60-2 Configuring Rights for the Trusted User in Windows Impersonation**

### 60.3.4 Binding the Trusted User to Your WebGate

You need to bind the trusted user to the WebGate by supplying the authentication credentials for the trusted user.

The procedure presumes that you have registered an 11g WebGate with Access Manager. The values in the procedure are provided as an example only. Your environment will be different.

---



---

#### See Also:

[Registering and Managing OAM 11g Agents](#)

---



---

1. In the Oracle Access Management Console, click **Application Security** at the top of the window.
2. In the **Launch Pad** tab, click **Agents**.
3. Find the desired 11g WebGate registration to modify for this integration:
  - **Find All Enabled:** Select **State All**, click the **Search** button, click the desired Webgate name in the results list.
4. On the WebGate registration page, enter the SharePoint username and password for the trusted user account, which you created earlier.
5. Click **Apply** to commit the changes.

A bind has been created for the WebGate and the trusted user. The WebGate is now ready to provide impersonation on demand. The demand is created by an Authorization Success Action in the application domain created for impersonation.

### 60.3.5 Adding an Impersonation Response to An Application Domain

You must create or configure an application domain to protect your OWA resources.

For this you must add Responses in Authorization Policies (Header type Responses), as described in this procedure.

**See Also:**

[Managing Policies to Protect Resources and Enable SSO](#) in the *Oracle Fusion Middleware Administrator's Guide for Oracle Access Management*.

The procedure presumes that you have an application domain created for the 11g WebGate you registered. The application domain in this example is *MyImpersonationDomain*. Your environment will be different.

1. In the Oracle Access Management Console, click **Application Security** at the top of the window.
2. Click **Application Domains** in the **Access Manager** section.
3. Search for and open the OWA Application Domain (the relevant application domain for impersonation).

Navigate as follows:

Authorization Policies  
Protected Resource Policy  
Responses

4. Click the **Add** button, then **Add Response**.

Complete the form as follows:

- From the **Type** list, choose **Header**.
- In the **Name** field, type a unique name for this response. For example, *IMPERSONATE*.
- In the **Value** field, type a value for this response. For example, *\$user.userid*.

5. Click **Add**, then click **Apply** to submit the changes.

This Response is used for the second WebGate request (for authorization).

### 60.3.6 Adding an Impersonation DLL to IIS

You are ready to configure IIS by adding the `IISImpersonationModule.dll` to your IIS configuration.

To add an Impersonation DLL to IIS:

1. Select **Start > Administrative Tools > Internet Information Services (IIS) Manager**.
2. In the left pane of IIS 7.x, click the hostname.
3. In the middle pane, under the "IIS" header, double click on "Modules".
4. In the right pane, click "Configure Native Modules" and click "Register".
5. In the window, provide a module **Name** (for example, *Oracle Impersonation Module*).
6. In the **Path** field, type the full path to `IISImpersonationModule.dll`.

By default, the path is:

```
Webgate_install_dir\webgate\iis\lib\IISImpersonationModule.dll
```

Where *Webgate\_install\_dir* is the directory of your WebGate installation.

---

---

**Note:**

If any spaces exist in the path (for example, `C:\Program Files\Oracle\...`) surround the entire string with double quotes (" ").

---

---

7. Click **OK** to register the module.
8. Check the name of the newly created module and click **OK** to apply the module across the Web sites.
9. Remove the module from the **Default** site level (otherwise, it inherits when you add it on the machine level).
10. Ensure that the `IISImpersonationModule.dll` file added in these steps is applied only to "owa" and "ecp" applications and removed from the site level.

Go to OWA, double-click **modules, Configure Native Modules**, and check the desired module (for example, **Oracle Impersonation Module**).

Go to (ecp): Double-click **modules, Configure Native Modules**, and check the desired module (for example, **Oracle Impersonation Module**).

### 60.3.7 Testing Impersonation

You can test Impersonation using an Event Viewer or a web page.

Following are the two ways of testing Impersonation:

- [Testing Impersonation Using the Event Viewer](#)
- [Testing Impersonation using a Web Page](#)

#### 60.3.7.1 Creating an IIS Virtual Site

To test the impersonation feature outside the Microsoft OWA 2010 context or to test single sign-on, you will need a target Web page on an IIS virtual Web site.

You create such a virtual Web site by performing the following task.

1. Click **Start > Administrative Tools > Internet Information Services (IIS) Manager**.
2. Click the plus icon (+) to the left of the local computer icon on the tree in the left pane.
3. Right-click **Web Sites** on the tree in the left pane, then select **New**, then select **Web Site** on the menu.
4. Respond to the prompts by the Web site creation wizard.
5. After you create the virtual site, you must protect it with an application domain, as described elsewhere in this guide.



```
<TD>Value</TD></TR>
<%for each servervar in request.servervariables%>
<TR>
<TD><%=servervar%></TD>
<TD> </TD>
<TD><%=request.servervariables(servervar)%> </TD>
</TR>
```

2. Create an IIS virtual site, or use the one you created for the previous task.
3. Place a .asp page or Perl script (such as the sample in the preceding listing) anywhere in the tree of the new virtual site.
4. Point your browser at the page. The page should display, with both AUTH\_USER and IMPERSONATE set to the name of the user making the request.

## 60.4 Setting Up Impersonation for Outlook Web Application (OWA)

In a distributed Exchange/OWA single sign-on environment, each server needs Access Manager to impersonate the current user. When you enable Impersonation, you need to include additional HTTP headers in the "Response" tab of the Authorization Policy of your impersonation application domain.

The following solution has been tested in both standalone and distributed OWA environments.

1. Install Access Manager 11g, as described in the *Oracle Fusion Middleware Installation Guide for Oracle Identity and Access Management*.
2. Install a 11g WebGate on all OWA client servers, as described in the *Oracle Fusion Middleware Administrator's Guide for Oracle Access Management*.
3. On the WebGate registration page, Disable IP Checking for Webgates on the back-end server using the AccessGate (because the request comes from the front-end server, not from the user's browser).
4. Ensure that OWA is not using Integrated Windows Authentication, as described in "[Prerequisites to Setting Impersonation for Outlook Web Application](#)".
5. Create a trusted user account for only impersonation in the Active Directory, as described in "[Creating a Trusted User Account for Outlook Web Application](#)".
6. Give the trusted user the special right to act as part of the operating system, as described in "[Assigning Rights to the Outlook Web Application Trusted User](#)".
7. Bind the trusted user to the WebGate by supplying the authentication credentials for the trusted user, as described in "[Binding the Trusted Outlook Web Application User to Your WebGate](#)".
8. Add a header variable named *impersonate* to the Authorization Policy Response tab (in the impersonation application domain), as described in, as described in "[Adding an Impersonation Action to an Application Domain for Outlook Web Application](#)".
9. Configure IIS by adding `IISImpersonationModule.dll` to your IIS configuration, as described in "[Adding an Impersonation dll to IIS](#)".
10. Test Impersonation, as described in "[Testing Impersonation for Outlook Web Application](#)".



---

**See Also:**

["Enabling Impersonation With a Header Variable"](#).

---

### 60.4.1 Prerequisites to Setting Impersonation for Outlook Web Application

Before you proceed with impersonation setup for Outlook Web Application, ensure that OWA is not using Integrated Windows (or any other) Authentication.

If it is not, you can use the following steps to set up OWA with Windows Authentication.

1. Open Exchange Management console.
2. Go to Server Configuration and click Client Access.
3. Select Outlook Web Access and click Properties.
4. In the Properties dialog box, click the Authentication tab.
5. Clear (unselect) all the authentication methods.
6. Click Apply, and click OK.
7. Restart the IIS server.
8. Proceed with ["Creating a Trusted User Account for Outlook Web Application."](#)

### 60.4.2 Creating a Trusted User Account for Outlook Web Application

The special user should not be used for anything other than impersonation. Oracle recommends that you chose a very complex password, because your trusted user is being given very powerful permissions.

Also, be sure to check the box marked Password Never Expires. Since the impersonation module should be the only entity that ever sees the trusted user account, it would be very difficult for an outside agency to discover that the password has expired.

To create a Trusted User Account for Outlook Web Application:

1. On the Windows 2008 machine, select Start; Programs; Administrative tools, Active Directory Users and Computers.
2. In the Active Directory Users and Computers window, right-click Users on the tree in the left pane, then select New; User.
3. In the First name field of the pane entitled New Object - User, enter an easy-to-remember name such as OWAImpersonator.
4. Copy this same string to the User logon name field, then click Next.
5. In succeeding panels, you will be asked to choose a password and then retype it to confirm.
6. Proceed to ["Assigning Rights to the Outlook Web Application Trusted User"](#).

### 60.4.3 Assigning Rights to the Outlook Web Application Trusted User

You need to give the trusted user the right to act as part of the operating system.

To assign rights to the Outlook Web Application trusted user:

1. Select Control Panel, Administrative Tools; and click either the Domain Controller Security Policy (if the computer is a domain controller) or Local Security Policy.
2. On the tree in the left pane, click the plus icon (+) next to Local Policies.
3. Click User Rights Assignment on the tree in the left pane.
4. Double-click "Act as part of the operating system" in the right pane.
5. Click Add User or Group.
6. In the Add User or Group panel, type the User logon name of the trusted user (OWAImpersonator in our example) in the User and group names text entry box, then click OK to register the change.
7. Proceed to "[Binding the Trusted Outlook Web Application User to Your WebGate.](#)"

#### 60.4.4 Binding the Trusted Outlook Web Application User to Your WebGate

You need to bind the trusted user to the WebGate by supplying the authentication credentials for the trusted user.

When the bind has been created for the WebGate and the trusted user, WebGate is ready to provide impersonation on demand. The demand is created by a Response set in the Authorization Policy of application domain created for impersonation.

The following procedure presumes that you have registered a 11g WebGate (*ImpersonateAgent*) with Access Manager. The values in the following procedure are provided as an example only. Your environment will be different.

---

---

**See Also:**

[Registering and Managing OAM 11g Agents](#) in the *Oracle Fusion Middleware Administrator's Guide for Oracle Access Management*

---

---

1. In the Oracle Access Management Console, click **Application Security** at the top of the window.
2. in the **Launch Pad** tab, click **Agents**.
3. Find the desired 11g WebGate registration to modify for this integration. For example: ImpersonateAgent.
  - **Find All Enabled:** Select State All, click the Search button, click the desired Webgate name in the results list.
4. Open the Webgate registration page and enter the SharePoint username and password for the trusted user account, which you created earlier.
5. Click **Apply** to commit the changes.

A bind has been created for the Webgate and the trusted user. The Webgate is now ready to provide impersonation on demand. The demand is created by an Authorization Success Action in the application domain created for impersonation.

## 60.4.5 Adding an Impersonation Action to an Application Domain for Outlook Web Application

You must create or configure a application domain to protect your OWA resources (/owa and /ecp only).

Ensure that `IISImpersonationModule.dll` is applied only to "owa" and "ecp" applications in IIS7.x, and removed from the site level. The Authorization policy must set several HTTP Header variables (Header type Responses in the Authorization policy).

This procedure presumes that you have an existing application domain for the 11g WebGate (*ImpersonateAgent*) you registered with Access Manager.

---

### See Also:

The chapter on managing policies to protect resources and enable SSO in the *Oracle Fusion Middleware Administrator's Guide for Oracle Access Management*.

---

1. In the Oracle Access Management Console, click **Application Security** at the top of the window.
2. Click **Application Domains** in the **Access Manager** section.
3. Search for and open the OWA2010 Application Domain (the relevant application domain for impersonation).

Navigate as follows:

Authorization Policies  
Protected Resource Policy  
Responses

4. Click the **Add** button, then **Add Response**.

Complete the form as follows:

- From the **Type** list, choose **Header**.
- In the **Name** field, type a unique name for this response. For example, `IMPERSONATE`.
- In the **Value** field, type a value for this response. For example, `$user.userid`.

5. Click **Add**, then click **Apply** to submit the changes.
6. Go to the next section, "[Adding an Impersonation DLL to IIS](#)."

This Response is used for the second Webgate request (for authorization).

## 60.4.6 Adding an Impersonation dll to IIS

You are ready to configure IIS by adding the `IISImpersonationModule.dll` to your IIS configuration.

You also need to set Enable Anonymous Access because this is required for impersonation of a user.

1. Select **Start, Administrative Tools, Internet Information Services (IIS) Manager**.
2. In the left pane of IIS 7.x, click the hostname.
3. In the middle pane, under the **IIS** header, double click on **Modules**.
4. In the right pane, click **Configure Native Modules** and click **Register**.
5. In the window, provide a module **Name** (for example, *Oracle Impersonation Module*).
6. In the **Path** field, type the full path to `IISImpersonationModule.dll`.

By default, the path is:

```
Webgate_install_dir\webgate\iis\lib\IISImpersonationModule.dll
```

Where *Webgate\_install\_dir* is the directory of your WebGate installation.

---



---

**Note:**

If any spaces exist in the path (for example, `C:\Program Files\Oracle\...`) surround the entire string with double quotes (" ").

---



---

7. Click **OK** to register the module.
8. Check the name of the newly created module and click **OK** to apply the module across the Web sites.

## 60.4.7 Configuring IIS Security

Be sure to configure IIS Security before you continue. [Figure 60-4](#) shows an example.

**Figure 60-4 Impersonation Authentication**

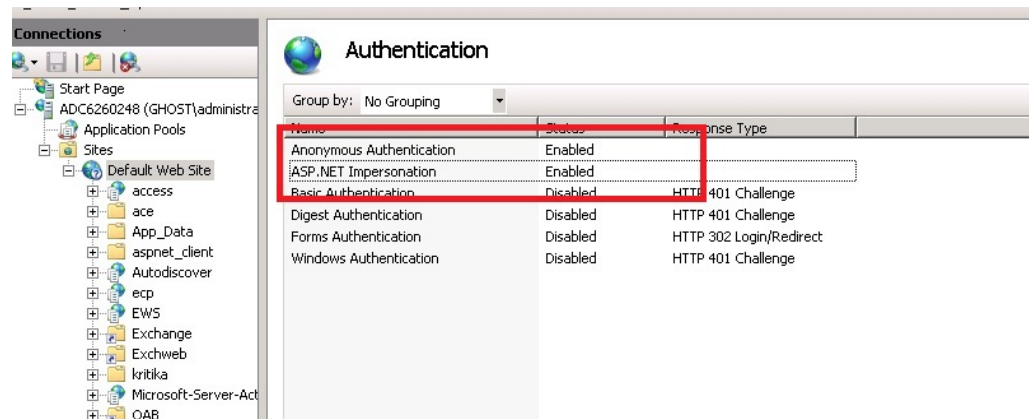

1. Select **Start, Administrative Tools, Internet Information Services (IIS) Manager**.
2. Click the plus icon (+) to the left of the local computer icon on the tree in the left pane.
3. Click **Web Sites** on the tree in the left pane.

4. In the center pane, double-click **Authentication** under IIS.
5. Ensure that **Anonymous Authentication** is enabled and **Windows Authentication** is disabled.

## 60.4.8 Testing Impersonation for Outlook Web Application

The following options are provided to test the Impersonation configuration for OWA.

- [Testing Impersonation Using the Event Viewer](#)
- [Testing Impersonation using a Web Page](#)

### 60.4.8.1 Testing Impersonation Using the Event Viewer

You can test impersonation through the Event Viewer.

To test:

1. Select **Start Menu; Event Viewer**.
2. In the left pane, right-click **Security**, then click **Properties**.
3. Click the **Filter** tab on the **Security** property sheet.
4. Verify that all Event Types are checked, and the Event Source and Category lists are set to All, then click **OK** to dismiss the property sheet.
5. Your Event Viewer is now configured to display information about the headerVar associated with a resource request.
6. Create a new IIS virtual server (virtual site).
7. Place a target Web page anywhere in the tree on the virtual site.
8. From your browser, enter the URL to the Web page.

If impersonation is working correctly, the Event Viewer will report the success of the access attempt.

### 60.4.8.2 Testing Impersonation using a Web Page

You can test impersonation using a dynamic test page that can return and display information about the request.

To test:

1. Create a .asp page or Perl script that will display the parameters AUTH\_USER and IMPERSONATE.

It can resemble this sample page:

```
<TABLE border=1>
<TR>
<TD>Variable</TD>
<TD> </TD>
<TD>Value</TD></TR>
<%for each servervar in request.servervariables%>
<TR>
<TD><%=servervar%></TD>
<TD> </TD>
```

```
<TD><%=request.servervariables(servervar)%> </TD>
</TR>
```

2. Create an IIS virtual site, or use the one you created for the previous task.
3. Place the a .asp page or Perl script (such as the sample in the preceding listing) anywhere in the tree of the new virtual site.
4. Point your browser at the page, which should appear, with both AUTH\_USER and IMPERSONATE set to the name of the user making the request.

### 60.4.8.3 Conducting Negative Testing for Impersonation

You can conduct negative testing for impersonation by unbinding the trusted user from the WebGate.

To conduct:

1. In the Oracle Access Management Console, click **Application Security** at the top of the window.
2. In the **Launch Pad** tab, click **Agents**.
3. Search for the desired WebGate and open it for editing.
4. In the WebGate registration page, remove the credentials for the trusted user.
5. Click **Apply** to save the change.
6. Restart the IIS server and in a browser window, go to a protected code page (previously accessible to the trusted user).
7. Confirm that you receive a message page. Values for AUTH\_USER and IMPERSONATE are necessary for impersonation credentials to be bound to a Webgate.
8. Restore the trusted user to the WebGate registration page.

## 60.5 Setting Up Access Manager WNA for Outlook Web Application

Access Manager 11g can operate with Windows Native Authentication (WNA).

This section describes setting up Access Manager with Windows Native Authentication (WNA) for Outlook Web Application (OWA).

Enabling WNA for the IIS Site front-ending OWA is described in the following procedure. It presumes a fully-configured Microsoft Active Directory authentication service is set up with user accounts to map Kerberos services, Service Principal Names (SPNs) for those accounts, and key tab files. For more information, see *Oracle Fusion Middleware Securing Oracle WebLogic Server 11g Release 1 (10.3.3) E13707-03*.

You need to configure Access Manager to use Windows Native Authentication (WNA), as described in [Configuring Access Manager for Windows Native Authentication](#).

1. Perform all prerequisite tasks.
2. Open IIS Authentication (OWA on the front-ending Site).
3. Enable **Windows authentication**.

4. Click on **Provider**.
5. Add **Negotiate** to **Provider** and move it to the top of the list.

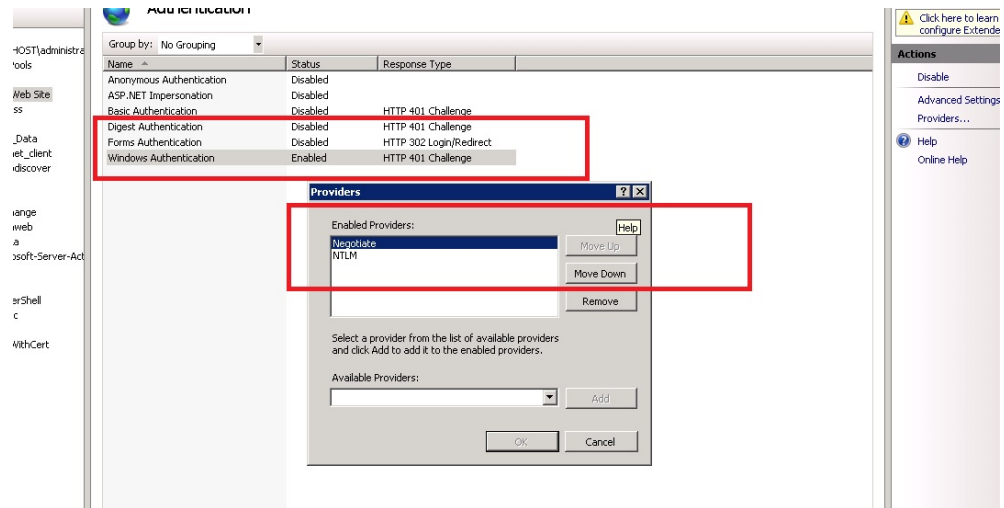

6. Create a policy to protect OWA in IIS, as described in the *Oracle Fusion Middleware Administrator's Guide for Oracle Access Management*.





---

# Integrating Microsoft Forefront Threat Management Gateway 2010 with Access Manager

This chapter describes how to configure communication between Access Manager and Microsoft Forefront Threat Management Gateway (TMG) 2010. The following sections are provided:

- [What is New in This Release?](#)
- [Introduction to Integration with TMG Server 2010](#)
- [Creating a Forefront TMG Policy and Rules](#)
- [Installing and Configuring 10g Webgate for Forefront TMG Server](#)
- [Configuring the TMG 2010 Server for the ISAPI 10g Webgate](#)
- [Starting, Stopping, and Restarting the TMG Server](#)
- [Removing Access Manager Filters Before WebGate Uninstall on TMG Server](#)
- [Troubleshooting](#)

## 61.1 What is New in This Release?

Support for integration between Access Manager and Microsoft Forefront Threat Management Gateway (TMG) 2010.

Details in this chapter presume that you are familiar with Access Manager policies and operation.

## 61.2 Introduction to Integration with TMG Server 2010

This section provides an overview of the tasks that, once performed, enable this integration. Topics included are:

- [About This Integration](#)
- [About Confirming Certification Requirements](#)

### 61.2.1 About This Integration

Microsoft Forefront Threat Management Gateway (TMG) 2010 is the next generation of the Internet Security and Acceleration (ISA) Server 2006.

This chapter provides steps to configure an open (non-secured) connection between the Forefront TMG Web server and Access Manager. This communication is based on

using a 10g Webgate for ISAPI. For details about using a secured connection, see your Forefront TMG Server documentation.

You can have IIS Web server and Forefront TMG installed on same or on different computer. In examples in this chapter, both reside on same host.

The following overview outlines the tasks that you must perform and the topics where you will find the steps to set up the ISAPI Webgate with the TMG Server within this chapter.

Task overview: Installing and configuring the ISAPI Webgate on TMG Server

1. Getting the latest certification matrix as described in "[About Confirming Certification Requirements](#)".
2. "[Creating a Forefront TMG Policy and Rules](#)"
3. "[Installing and Configuring 10g Webgate for Forefront TMG Server](#) "
4. "[Configuring the TMG 2010 Server for the ISAPI 10g Webgate](#)"

## 61.2.2 About Confirming Certification Requirements

Any references to specific versions and platforms in this chapter are for demonstration purposes. For the latest certification information, see Oracle Technology Network at:

<http://www.oracle.com/technetwork/middleware/ias/downloads/fusion-certification-100350.html>

## 61.3 Creating a Forefront TMG Policy and Rules

After you install Forefront TMG 2010, other computers cannot ping the computer hosting Forefront because the default firewall policy denies all the traffic from and to the host.

This section provides the information you need for:

- [Creating a Custom Policy for Forefront TMG](#)
- [Creating a Forefront TMG Firewall Policy Rule](#)
- [Verifying Forefront TMG Proxy Configuration](#)

### 61.3.1 Creating a Custom Policy for Forefront TMG

You can create a custom Forefront firewall policy.

Prerequisites:

Install Forefront TMG 2010 using documentation from your vendor.

To create a custom policy to over ride the default firewall policy

1. Open the Forefront TMG console: Start, Programs, Microsoft Forefront TMG, Forefront TMG Management.
2. From the left pane, click Firewall Policy.
3. From the right pane, click Create Access Rule to create a custom policy,
4. Create a rule with the following attributes and values assigned:

- Name: *Name for custom policy*
  - Action =Allow
  - Protocol =All Outbound
  - Malware Inspection = Don not enable Malware Inspection for this rule
  - From =External,Internal,Local Host
  - To= External,Internal,Local Host
  - Condition =All Users
5. Click **Next** to create the Access Rule, then click **Apply**.
  6. Restart Forefront TMG to have changes take affect:
    - Stop Firewall Service use the command `net stop fwsrv`
    - Start Firewall Service use the command `net start fwsrv`
  7. Proceed to "[Creating a Forefront TMG Firewall Policy Rule](#)"

### 61.3.2 Creating a Forefront TMG Firewall Policy Rule

To protect the resource, you must create a firewall policy rule using the Forefront TMG console.

When you create a listener for Authentication Preferences, be sure to check Allow client authentication over HTTP and Require All users to authenticate. Otherwise, you will not be able to access the published Web site using the TMG proxy.

Authentication Delegation is used by the TMG server to authenticate to the published Web server.

---

---

**Note:**

You can have IIS and Forefront TMG installed on the same (or a different) computer. Here, both reside on same host.

---

---

To create a custom policy to override the default firewall policy

1. Open the Forefront TMG console: Start, Programs, Microsoft Forefront TMG, Forefront TMG Management.
2. From the left pane, click Firewall Policy.
3. From the Tasks tab, click Publish Web Sites.
4. In the Web publishing rule name field, type a descriptive name for the rule, and then click Next.
5. On the Select Rule Action page, confirm that the Allow option is selected, and then click Next.
6. In the Publishing type, confirm that the Publish a single Web site or load balancer option is selected, and then click Next.

Step 7 describes configuration with an open (non-secured) connection with the Web server. If you are using a secured connection, see your Forefront TMG Server documentation.

7. On the Server Connection Security page, click Use non-secured connections to connect the published Web server or server farm, and then click Next.
8. Perform the following steps to set internal publishing details:
  - In the Internal site name field, type the internally-accessible name of the IIS/apache Web server host: *iis\_host.us.example.com*, for example.
  - Check the box beside Use a computer name or IP address to connect to the published serve (or enter the IP address of the IIS Web server host).
  - Click **Next**.
9. Protecting Resources: Perform following steps to protect resources within a particular folder in the Web site (or a single resource):

---

---

**Note:**

The folder must reside within `htdocs/wwwroot` of the corresponding Web server.

---

---

- Folder Containing Resources: In the **Path** field, type the folder name to display the full path of the published Web site in the Web site field (`Res/*` for example).
  - Single Resource: Type the resource name (`test.html` for example).
  - Click **Next**.
10. In the Accept requests for list:
    - Click your domain name (for example: `myhost.example.com`).
    - In the Public name field, type the publicly-accessible fully-qualified Web site domain name of the host where Forefront TMG will be installed (for example: `myhost.example.com`).
    - Click **Next**.
  11. In the Web listener list, either click the Web listener to use for this Web publishing rule, or create a new Web listener as follows:

---

---

**Note:**

Listener can also be configured in SSL mode if required; see your Forefront TMG documentation.

---

---

- Click **New**, type a descriptive name for the new Web listener, and then click **Next**.
- Click **Do not require SSL secured connections with clients**, and then click **Next**.

- In the Listen for requests from these networks list, click the required networks (**External**, **Internal**, and **Localhost**) then click **Next**.
  - Click **No** on the message that appears.
  - In the Select how clients will provide credentials to Forefront TMG Server list, click No Authentication, and then click Next.
  - On the Single Sign On Settings page, click Next, and then click Finish.
12. On the Select Web Listener page:
- Click **Edit**.
  - Click connections tab.
  - Provide any unused port for Enable HTTP connections on port attribute (This will act as Forefront TMG port.)
  - Click **Apply**; click **Ok**.
  - Click **Next**.
  - On the Single Sign On Settings page, click **Next**, and then click **Finish**.
13. Authentication Delegation: Perform the following steps to choose the method used by Forefront TMG to authenticate to the published Web server list.
- Click **No Delegation**, and **Client Cannot Authenticate Directly**.
  - Click **Next**.
14. On the User Sets page:
- Choose **All** (the default user setting - All Users) to set the rule that applies to requests from the user sets field.
  - Click **Next**, and then click **Finish**.
15. Click **Apply** to update the firewall policy, and then click **OK**.
16. Double-click the recently created **Firewall Policy**.
17. Bridging:
- Open the **Bridging** tab.
  - Provide suitable unused port for Redirect request to HTTP port attribute (which will act as the IIS or Apache Web server port).
18. Click **Apply** to update the firewall policy, and then click **OK**.
19. IIS or Apache Web server.
20. Restart Forefront TMG to have changes take affect:
- Stop Firewall Service use the command net stop fwsrv
  - Start Firewall Service use the command net start fwsrv
21. Double-click the rule just created:

- Open the **Link Translation** tab.
- Confirm that **Apply Link Translation** to this rule is checked.
- Click the **Mapping** button to see the mapping created between Forefront TMG and IIS or Apache

22. Proceed to "[Verifying Forefront TMG Proxy Configuration](#)"

### 61.3.3 Verifying Forefront TMG Proxy Configuration

You can validate the Forefront TMG proxy configuration, you can simply access the protected resource using the TMG port.

To verify Forefront TMG proxy configuration:

1. **Protected Single Resource:** Enter the URL to the TMG host and port where the protected resource resides. For example:

```
http://TMG_hostname:TMG_port/resource_name
```

2. **Protected Folder:** Enter the URL to the TMG host and port where the folder containing the resource resides. For example:

```
http://TMG_hostname:TMG_port/folder-name/resource_name
```

3. Confirm there are no issues accessing the protected resource.

## 61.4 Installing and Configuring 10g Webgate for Forefront TMG Server

You can set up the 10g Webgate and register plug-ins as Web filters.

Task overview: Configuring Webgate and Filters for TMG Server includes

1. [Installing 10g Webgate with TMG Server](#)
2. [Changing /access Directory Permissions](#)
3. [Registering Access Manager Plug-ins as TMG Server Web Filters](#)
4. [Ordering the ISAPI Filters](#)
5. [Verifying Form-based Authentication](#)

### 61.4.1 Installing 10g Webgate with TMG Server

When you install Webgate with the Forefront TMG Server, the destination for the ISAPI Webgate installation (also known as the *Webgate\_install\_dir*) should be same as that of the Microsoft Forefront TMG.

For example, if Forefront TMG is installed in `C:\Program Files\Microsoft Forefront Threat Management Gateway`, the ISAPI Webgate should also be installed there.

Task overview: Installing the ISAPI Webgate for Forefront TMG Server

1. Register a 10g ISAPI Webgate with Access Manager, as described in [Registering and Managing 10g WebGates with Access Manager 11g](#).

---

**Note:**

During Webgate installation, select the TMG option.

---

2. Install the ISAPI Webgate for TMG, as described in [Locating and Installing the Latest 10g WebGate for Access Manager 11g](#).
3. Proceed to the "[Changing /access Directory Permissions](#)" section.

### 61.4.2 Changing /access Directory Permissions

After finishing ISAPI Webgate installation and configuration for the Forefront TMG Server, you must change permissions to the `\access` subdirectory.

This subdirectory was created in the Forefront TMG Server (also Webgate) installation directory. You must add the user NETWORK SERVICE and grant full control to SYSTEM ADMINISTRATOR. This enables the Forefront TMG Server to establish a connection between the Webgate and Access Server. Certain configuration files should be readable by system administrators, which is why you grant SYSTEM ADMINISTRATOR full control.

---

**Note:**

Webgate in Simple Mode: add user NETWORK SERVICE and give Full Control for the `password.xml` file in `TMG_install_dir\access\oblix\config\password.xml`.

---

To change permissions for the `\access` subdirectory

1. In the file system, right-click `Webgate_install_dir\access`, and select **Properties**.
2. In the Properties window, click the **Security** tab.
3. Add user "NETWORK SERVICE" and then select "Allow" to give **Full Control**.
4. For the "SYSTEM ADMINISTRATOR", select **Full Control**.
5. Proceed to the "[Configuring the TMG 2010 Server for the ISAPI 10g Webgate](#)" section.

### 61.5 Configuring the TMG 2010 Server for the ISAPI 10g Webgate

You can configure the TMG Server to operate with the 10g ISAPI Webgate for Access Manager.

Task overview: Configuring the TMG 2010 Server for the ISAPI 10g Webgate

1. [Registering Access Manager Plug-ins as TMG Server Web Filters](#)
2. [Ordering the ISAPI Filters](#)
3. [Verifying Form-based Authentication](#).

## 61.5.1 Registering Access Manager Plug-ins as TMG Server Web Filters

After resetting ISAPI Webgate permissions, you need to register Access Manager `webgate.dll` and `postgate.dll` plug-ins as Web Filters within Forefront TMG Server.

Web filters screen all HTTP traffic that passes through the TMG Server host. Only compliant requests are allowed to pass through. The following procedure describes how to register Access Manager plug-ins in the TMG Server.

---

---

**Note:**

To undo the filter registration, you can use the following procedure with the `/u` option in the `regsvr32` command. For example: `regsvr32 /u TMG_install_dir\access\oblix\apps\webgate\bin\webgate.dll`

---

---

To register Access Manager plug-ins as TMG Server Web filters

1. Locate the TMG Server installation directory, from which you will perform the following tasks.
2. Run `net stop fwsrv` to stop the TMG Server.
3. Register the `webgate.dll` as an ISAPI Web filter by running:  

```
regsvr32 TMG_install_dir\access\oblix\apps\webgate\bin\webgate.dll
```
4. Register the `postgate.dll` as an ISAPI Web filter by running:  

```
regsvr32 TMG_install_dir\access\oblix\apps\webgate\bin\postgate.dll
```
5. Restart the TMG Server by running `net start fwsrv`.
6. Proceed to "[Ordering the ISAPI Filters](#)".

## 61.5.2 Ordering the ISAPI Filters

It is important to ensure that the Webgate ISAPI filters are included in the right order. `postgate.dll` should be loaded before `webgate.dll`.

To order the Webgate ISAPI filters for TMG Server

1. From the **Start** menu, click **All Programs**, click **Microsoft Forefront TMG**, then click **Forefront TMG Management**.
2. In the left pane, select **System**, then select **Web Filters**, to display your Web-filters.
3. Confirm the following .dll files appear.

For example:

```
postgate.dll
webgate.dll
```

4. Add any missing filters, if needed, then select a filter name and use the up and down arrows to arrange the filter order as shown in Step 3.



5. Proceed with "[Verifying Form-based Authentication](#)".

### 61.5.3 Verifying Form-based Authentication

You need to ensure that the published Web site is accessible using the TMG proxy and verify that form-based authentication is working.

TMG supports both Basic over LDAP and Form-based or Basic authentication. You can choose the desired authentication scheme. TMG need access to `login.html`, which you configure as described here.

To verify that form-based authentication is working

1. Store the login page at the docroot of the Web server protecting the resource so that the TMG server can access the login page.
2. Ensure that the published Web site is accessible to the TMG proxy.
3. Open the Forefront TMG console: **Start, Programs, Microsoft Forefront TMG, Forefront TMG Management**.
4. From the left pane, select the **Firewall Policy**.
5. On the right, under the Firewall Policy Rule, select the rule that was created to protect the resource.
6. Go to the policy rule properties, select the Path tab, then add the `/login.html` and click **OK**.
7. Click **Apply** to save changes and update the configuration.
8. Restart Forefront TMG to have changes take affect:
  - Stop Firewall Service use the command `net stop fwsrv`
  - Start Firewall Service use the command `net start fwsrv`

### 61.6 Starting, Stopping, and Restarting the TMG Server

When instructed to restart your TMG Server during Access Manager Web component installation or setup, be sure to follow any instructions that appear on the screen.

Also, the `net` commands help to ensure that the Metabase does not become corrupted following an installation. Consider the following commands, which provide good ways to stop and start the TMG Server:

- `net stop fwsrv`
- `net start fwsrv`

For more information, see your TMG Server documentation.

### 61.7 Removing Access Manager Filters Before WebGate Uninstall on TMG Server

If you plan to uninstall the Webgate that is configured to operate with the TMG Server, you must first unregister the Access Manager filters manually, and then uninstall Webgate.

To unregister filters before WebGate uninstall:

1. Stop the TMG Server.
2. Run the following command to unregister `webgate.dll`. For example:  

```
regsvr32 /u TMG_install_dir\access\oblix\apps\webgate\bin\webgate.dll
```
3. Run the following command to unregister `postgate.dll`. For example:  

```
regsvr32 /u TMG_install_dir\access\oblix\apps\webgate\bin\postgate.dll
```

## 61.8 Troubleshooting

The error "Failed Connection Attempt" in TMG logs on accessing any Access Manager protected resource does not affect functionality and can be ignored.

---

# Integrating Access Manager with SAP NetWeaver Enterprise Portal

This chapter describes the integration of Access Manager 11.1.2 with SAP NetWeaver Enterprise Portal.

This chapter covers the following topics:

- [What is Supported in This Release?](#)
- [Supported Versions and Platforms](#)
- [Integration Architecture](#)
- [Configuring Oracle Access Management and NetWeaver Enterprise Portal 7.0.x](#)
- [Configuring Oracle Access Management and NetWeaver Enterprise Portal 7.4.x](#)
- [Testing the Integration](#)
- [Troubleshooting the Integration](#)

## 62.1 What is Supported in This Release?

Versions 7.0.x and 7.4.x of SAP NetWeaver Enterprise Portal are supported in this release.

Access Manager supports SAP NetWeaver Enterprise Portal v7.4.x with the following caveats:

- Apache 2.2.x and 2.0.x (from Apache.org) are supported Web servers with this release.
- MySAP is not certified.

Access Manager supports SAP NetWeaver Enterprise Portal v6.0 and v7.0.x with the following caveats:

- Apache 2.0 (from Apache.org) is supported as a Web server with this release.
- MySAP is not certified.

## 62.2 Supported Versions and Platforms

Access Manager supports the versions and platforms described on the following site:

<http://www.oracle.com/technetwork/middleware/ias/downloads/fusion-certification-100350.html>

## 62.3 Integration Architecture

The following diagram illustrates the integration between Access Manager and SAP NetWeaver Enterprise Portal.

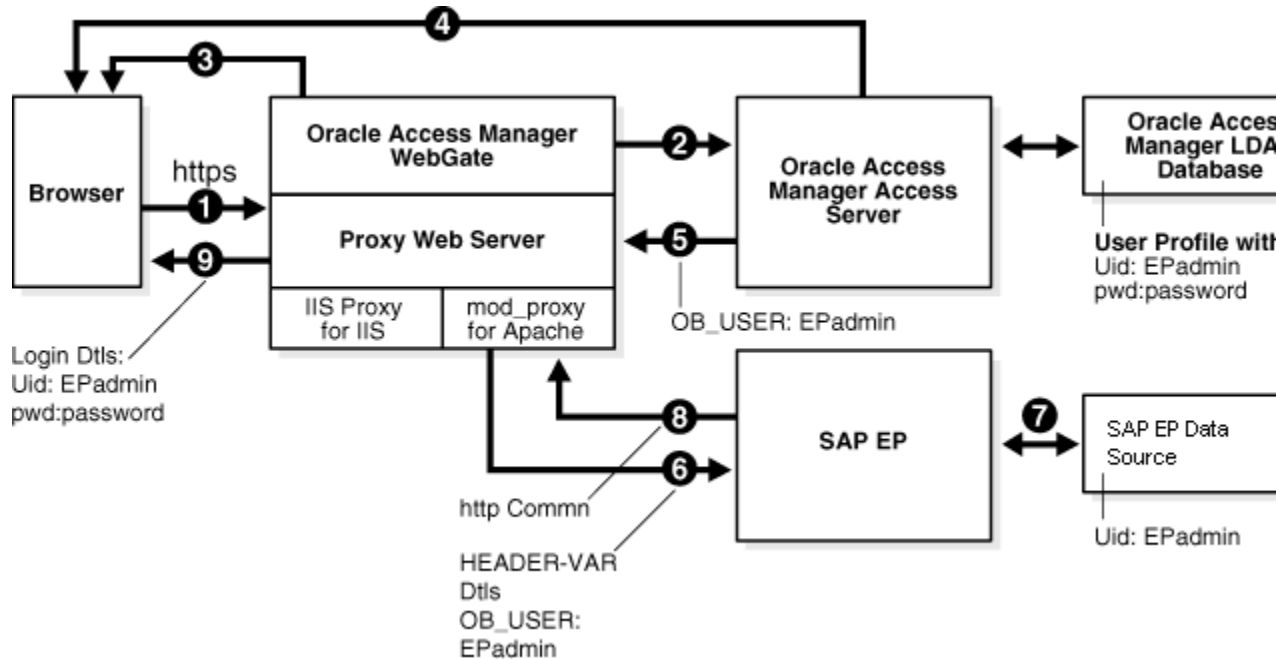

### 62.3.1 Process Overview: Integration with SAP NetWeaver Enterprise Portal

Here is an overview of the integration process with SAP NetWeaver Enterprise Portal.

- A user attempts to access content via the SAP NetWeaver Enterprise Portal.

For example, the user may enter the following URL to access an HR application through a proxy server:

```
https://host:port/irj
```
- The WebGate intercepts the request and queries the Access Server for the security policy that determines if the resource is protected.

The security policy consists of an authentication scheme, authorization rules, and allowed operations. Based on the authentication and authorization success or failure, specified actions are performed.

The Access System security policy for the SAP `/irj` login URL is applicable to all resources accessed using the `https://host:port/irj` URL.

Note that the SAP NetWeaver Enterprise Portal has its own authorization system that can be configured to set user access to iViews.
- If the resource is protected, the WebGate prompts the user for authentication credentials.

The credentials that the WebGate requests depend on the authentication scheme configured in the Access System, for example, Basic over LDAP or Form-based authentication.

4. If the credentials are validated, the Access System authenticates the user and sets an encrypted ObSSOCookie in the user's browser.
5. After authenticating, the authorization rules defined in the Access System are applied based on the security policy.

Specific actions are performed based on the authorization rules. If the user is authorized, access to the SAP Portal login (the requested content) is allowed. For SAP Enterprise Portal header variable integration, the Access Server sets the authenticated user ID in a header variable.

If the user is not authenticated or authorized, he or she is denied access and redirected to another URL, as determined by the administrator. For example, the user may be redirected to an "invalid credentials" page.
6. For the integration with SAP NetWeaver Enterprise Portal, the proxy Web server redirects the request to the SAP NetWeaver Enterprise Portal internal Web server that contains the header variable details.
7. The SAP NetWeaver Enterprise Portal uses the header variable value to check the mapping of the user ID against the configured data source in the portal.

Both the Access Manager and SAP NetWeaver Enterprise Portal data source must contain the same user ID value.

Upon successful mapping, SAP NetWeaver Enterprise Portal allows the user to access the requested resource.

SAP NetWeaver Enterprise Portal sends a response to the proxy, and the proxy redirects to the client browser.
8. All interaction with the SAP Enterprise Portal takes place through the proxy server.

## 62.4 Configuring Oracle Access Management and NetWeaver Enterprise Portal 7.0.x

You can configure Access Manager and SAP NetWeaver Enterprise Portal 7.0.x to work together.

This section contains the following tasks:

- [Before You Begin Configuring OAM and NetWeaver Enterprise Portal 7.0.x](#)
- [Configuring the Apache HTTP Server as a Proxy](#)
- [Configuring SAP NetWeaver Enterprise Portal for External Authentication](#)
- [Adjusting the Login Module Stacks for using Header Variables](#)
- [Configuring Access Manager for SAP Enterprise Portal](#)

### 62.4.1 Before You Begin Configuring OAM and NetWeaver Enterprise Portal 7.0.x

- Install SAP NetWeaver Enterprise Portal before completing the steps in this section.
- Install the Apache HTTP Server by following the installation steps provided by [apache.org](http://apache.org).

- Install and configure a WebGate on each Apache HTTP Server instance that supports the proxy connection to the SAP Enterprise Portal instance. See *Installing Webgates for Oracle Access Manager* for details.
- Install Access Manager before completing the steps in [Configuring Access Manager for SAP Enterprise Portal](#) . See the *Oracle Fusion Middleware Installation Guide for Oracle Identity and Access Management* for details.
- Synchronize the time on all servers where SAP NetWeaver Enterprise Portal and Access Manager components are installed.
- Ensure that the users exist in the Access Manager LDAP directory as well as on the SAP R3 system database.

The user ID in Access Manager and the SAP database must be the same or be mapped to each other. Any attribute in a user's profile can be configured as the SAP ID and passed directly to SAP. Alternatively, SAP can be configured to map the SAP ID to any user attribute that it receives from Access Manager.

- Verify that the Web browser is configured to allow cookies.

---

---

**Note:**

Oracle suggests reviewing the following topics prior to integrating Access Manager with SAP NetWeaver Enterprise Portal.

- [Managing Data Sources](#) to understand how to add and configure data sources in Access Manager.
  - [Managing Authentication and Shared Policy Components](#) to understand how to configure Form and Basic mode authentication in Access Manager.
  - [Configuring Cert Mode Communication for Access Manager](#) to understand how to configure Cert mode for Access Manager.
- 
- 

## 62.4.2 Configuring the Apache HTTP Server as a Proxy

You can configure a proxy (Apache HTTP Server 2.0.x) to access SAP NetWeaver Enterprise Portal.

To configure Apache HTTP Server 2.0.x

1. Set up the Apache HTTP Server proxy in non-SSL mode or SSL mode, as described in the Apache documentation.

If HTTPS communication is used with the SAP NetWeaver Enterprise Portal, use SSL mode.

2. To enable the proxy to access the SAP NetWeaver Enterprise Portal, enter the following in the `httpd.conf` configuration file:

For SAP NetWeaver Enterprise Portal 6:

```
ProxyRequests Off
ProxyPass /irj http://sap_host:port/irj
ProxyPassReverse /irj http://sap_host:port/irj
ProxyPreserveHost On
```

For SAP NetWeaver Enterprise Portal 7:

```
ProxyRequests Off
ProxyPass /webdynpro http://sap_host:port/irj
ProxyPassReverse /webdynpro http://sap_host:port/irj
ProxyPreserveHost On
```

Where *sap\_host* is the name of the machine hosting the SAP NetWeaver Enterprise Portal instance and *port* is the listen port for the SAP NetWeaver Enterprise Portal instance. This set of directives specifies that all of the requests to this Web server of the form `http://apache_host:port/irj` or `https://apache_host:port/irj` are redirected to `http://sap_host:port/irj` or `https://sap_host:port/irj`.

3. Restart the proxy Web server.

4. Access the following URL:

**Non-SSL**—`http://apachehost:port/irj`

**SSL**—`https://apachehost:port/irj`

This request should be redirected to the SAP NetWeaver Enterprise Portal login.

5. Log in using the SAP NetWeaver Enterprise Portal administrator login ID.

The administrator should be able to perform the available administrative functions.

6. Log in as a non-administrative user.

This user should be able to perform non-administrative functions.

### 62.4.3 Configuring SAP NetWeaver Enterprise Portal for External Authentication

You can enable external authentication in SAP Enterprise Portal using the `OB_USER` header variable.

For more information about configuring authentication schemes for SAP Enterprise Portal, see the SAP documentation.

To configure the header variable

1. Stop the SAP J2EE dispatcher and server.

2. Browse to the following directory:

`SAP_J2EE_engine_install_dir\ume`

3. Back up the file `authschemes.xml.bak` to another directory.

4. Rename `authschemes.xml.bak` to `authschemes.xml`.

5. Open `authschemes.xml` in an editor and change the reference of the default authentication scheme to the authentication scheme header as follows:

```
<authscheme-refs>
 <authscheme-ref name="default">
 <authscheme>header</authscheme>
 <authscheme>uidpwdlogon</authscheme>
 </authscheme-ref>
</authscheme-refs>
```

6. In the authentication scheme header of `authschemes.xml`, specify the name of the HTTP header variable where the Access System provides the user ID.

As described in "[Configuring Access Manager for SAP Enterprise Portal](#)", this is the `OB_USER` header variable. You configure this header variable as follows:

```
<authscheme name="header">
 <loginmodule>
 <loginModuleName>
 com.sap.security.core.logon.imp.HeaderVariableLoginModule
 </loginModuleName>
 <controlFlag>REQUISITE</controlFlag>
 <options>Header=OB_USER</options>
 </loginmodule>
 <priority>5</priority>
 <frontEndType>2</frontEndType>
 <frontEndTarget>com.sap.portal.runtime.logon.header</frontEndTarget>
</authscheme>
```

The control flag value `REQUISITE` means the login module must succeed. If login succeeds, authentication continues through the list of login modules. If it fails, control immediately returns to the application and authentication does not continue through the list of login modules.

- Restart the portal server and J2EE engine.

The modified `authschemes.xml` file will be loaded into the Portal Content Directory (PCD). SAP Enterprise Portal will rename it as `authschemes.xml.bak`.

### To Configure Logout

- To enable logout from a single sign-on session in both SAP Enterprise Portal and Access Manager, configure a logout URL in SAP Enterprise Portal from the administration interface.

The URL for the administration interface is as follows:

```
http://SAP_host:port/irj/
```

Where `SAP_host` is the name of the machine hosting the SAP Enterprise Portal and `port` is the listen port for the portal.

- From the administration interface, click System Administration, then System Configuration, then UM Configuration, then Direct Editing.
- Add the following lines to the end of the configuration file:

```
ume.logoff.redirect.url=http(s)://proxy_host:port/logout.html
ume.logoff.redirect.silent=false
```

Where `http(s)` is either `http` or `https`, `proxy_host` is the name of the proxy Web server, and `port` is the listen port for the proxy.

- Save the changes and log out.

## 62.4.4 Adjusting the Login Module Stacks for using Header Variables

Add the `HeaderVariableLoginModule` to the appropriate login module stack or template and configure the options.



**Table 62-1 Login Module Stacks for using Header Variables**

Login Modules	Flag	Options
EvaluateTicketLoginModule	SUFFICIENT	{ume.configuration.active=true}
HeaderVariableLoginModule	OPTIONAL	{ume.configuration.active=true, Header=<header_name>}
CreateTicketLoginModule	SUFFICIENT	{ume.configuration.active=true}
BasicPasswordLoginModule	REQUISITE	{}
CreateTicketLoginModule	OPTIONAL	{ume.configuration.active=true}

### To adjust the Login Module Stacks for using Header Variables

1. Run the Visual Administrator tool, in the following location:

```
SAPJ2EEEngine_install_dir\j2ee\admin\go.bat
```

2. In the Visual Administrator, choose **Security Provider**.
3. Switch to edit mode by choosing the pencil icon.
4. Choose **Policy Configurations**, then **Authentication**.
5. For each template or application that is to support header variable authentication, add the login module HeaderVariableLoginModule to the login module stack (see [Table 62-1](#)).

## 62.4.5 Configuring Access Manager for SAP Enterprise Portal

You can configure the security policy in Access Manager to protect log-ins to SAP NetWeaver Enterprise Portal.

To configure Access Manager for SAP NetWeaver Enterprise Portal

1. In the Oracle Access Management Console, click **Application Security** at the top of the window.
2. In the **Launch Pad** tab, select **Create Application Domain** from the **Create (+)** drop-down menu in the **Access Manager** section.

The Create OAM 11g Webgate page opens.

3. Complete the form to create a WebGate for this integration. For example:

**Name**—SAP\_AG

**Version** - 11g

**Host Identifier**—Apache proxy host

**Auto Create Policies**—Enabled (checked)

**Public Resource List**—Add any public Resources to this list.

**Apply**—Click to create the WebGate.

4. Click the **Authorization Policies** tab, then click the **Create Authorization Policy** button to open a fresh page ([Managing Policies to Protect Resources and Enable SSO](#)).
5. **Summary Tab:** Add your information to the Summary tab.
6. Click the Resources tab, click Add (+), and define the resources for the policies in this application domain as follows:
  - Name:** SAP EP Security Policy
  - Type:** http
  - Host identifiers:** Enter the proxy host URL prefix: /irj.
  - Description:** SAP EP Login URL
7. **Add Resources:** The Resource must be defined in the Application Domain before you can add the resource to a specific policy.
  - Click the **Resources** tab on the Authorization Policy page.
  - Click the **Add** button on the Resources tab.
  - Click the **Search** button.
  - Click a URL in the Results table, then click **Add Selected**.
  - Repeat these steps to add more resources.
8. Click **Apply** to save changes and close the Confirmation window.
9. **Responses:** Add policy Responses, as described in "[Adding and Managing Policy Responses for SSO](#)".
10. **Conditions:** Add authorization conditions, as described in "[Defining Authorization Policy Conditions](#)".
11. **Rules:** Add authorization rules, as described in "[Defining Authorization Policy Rules](#)".
12. Close the page when you finish.

## 62.5 Configuring Oracle Access Management and NetWeaver Enterprise Portal 7.4.x

This section contains the following tasks.

- [Before You Begin Configuring OAM and NetWeaver Enterprise Portal 7.4.x](#)
- [Configuring Access Manager for SAP NetWeaver Enterprise Portal 7.4.x](#)
- [Configuring Apache Web Server 2.0.x or 2.2.x](#)
- [Configuring SAP Enterprise Portal 7.4 for External Authentication](#)

- [Adjusting the Login Module Stacks for Using Header Variables](#)

## 62.5.1 Before You Begin Configuring OAM and NetWeaver Enterprise Portal 7.4.x

- Install SAP NetWeaver Enterprise Portal version 7.4.x before completing the steps in this section.
- Install Access Manager as described in the *Oracle Fusion Middleware Installation Guide for Oracle Identity and Access Management*.
- Install Apache HTTP Server 2.0.x or 2.2.x by following the installation steps provided by apache.org.
- Install and configure an 11g WebGate on each Apache HTTP Server instance that supports the proxy connection to the SAP Enterprise Portal 7.4 instance. See *Installing Webgates for Oracle Access Manager* for details.
- Synchronize the time on all servers where SAP NetWeaver Enterprise Portal and Access Manager components are installed.
- Ensure that the users exist in the Access Manager LDAP directory as well as on the SAP R3 system database.

The user ID in Access Manager and the SAP database must be the same or be mapped to each other. Any attribute in a user's profile can be configured as the SAP ID and passed directly to SAP. Alternatively, SAP can be configured to map the SAP ID to any user attribute that it receives from Access Manager.

- Verify that your Web browser is configured to allow cookies.

---

---

**Note:**

Oracle suggests reviewing the following topics prior to integrating Access Manager with SAP NetWeaver Enterprise Portal.

- [Managing Data Sources](#) to understand how to add and configure data sources in Access Manager.
  - [Managing Authentication and Shared Policy Components](#) to understand how to configure Form and Basic mode authentication in Access Manager.
  - [Configuring Cert Mode Communication for Access Manager](#) to understand how to configure Cert mode for Access Manager.
- 
- 

## 62.5.2 Configuring Access Manager for SAP NetWeaver Enterprise Portal 7.4.x

You can configure the Access Manager security policy that protects SAP NetWeaver Enterprise Portal log-ins.

To configure:

1. In the Oracle Access Management Console, click **Application Security** at the top of the window.
2. In the **Launch Pad** tab, select **Create Application Domain** from the **Create (+)** drop-down menu in the **Access Manager** section.

3. Complete the form to create a WebGate for this integration. For example:
  - Name**—Type a meaningful name, for example, *SAP\_AG*. Do not include spaces in the name.
  - Version** - select **11g** from the drop-down menu.
  - Access Client Password**—Enter a password to be used during the installation of the WebGate.
  - Security**—Choose the type of communication that should occur between the WebGate and the OAM server.Click **Apply**.

A confirmation page opens.
4. At the bottom of the confirmation page, in the **Server Lists** section, associate the WebGate with a defined Access Server.

Click **Apply**.
5. On the Launch Pad page, go to the **Access Manager** section and click **Host Identifiers**.

Click **Search**, then click the WebGate in the search results.

Configure the host identifiers using the fully qualified proxy machine name and port for the Apache proxy.
6. Click **Application Domains** and search for the application domain name that you used to create the WebGate (for example, *SAP\_WG*).

Click the application domain name in the search results to open it

  - a. Click the **Resources** tab and search for the resource that the WebGates should protect. Select the resource in the search results then click the **Create** button.

Complete the form and click **Apply**.

**Type** - HTTP

**Resource URL** - */irj*

**Protection Level** - Protected

**Authentication Policy** - Protected Resource Policy

**Authorization Policy** - Protected Resource Policy
  - b. Click the **Authentication Policies** tab, then click **Protected Resource Policy**.

Choose the appropriate authentication scheme from the **Authentication Scheme** drop-down that you want to configure for this particular domain. For example, for a form-based authentication policy (FAAuthScheme), enter the following:

**Name** - Protected Resource Policy

**Authentication Scheme** - FAAuthScheme

**Note:**

Select either basic-over-LDAP or form-based authentication.

Oracle recommends that you use a form-based authentication scheme. If you use the basic authentication scheme, also set the **Challenge Redirect** field to another WebGate to ensure that the `ObSSOCookie` is set.

Click **Apply** to save your changes.

- c. Click the **Authorization Policies** tab, then click **Protected Resource Policy**.

Click the **Responses** tab and add the following:

**Type** - Header

**Name** - OAM\_REMOTE\_USER

**Value** - Same account name

The other tabs in Authorization Policies include conditions and rules:

**Condition** - Creates a list of users and puts them in a group.

**Rule** - Allows or denies access to the group of users created in the conditions tab.

Click **Apply** to save your changes.

7. If you configured a form-based authentication scheme, ensure that a `login.html` page is configured in the proxy server document root.

Also, ensure that a `logout.html` page is present on the proxy Web server document root. You can create a custom logout page using HTML, a JSP file, or a CGI protocol.

The default logout page (`logout.html`) is located here:

`WebGate_install_dir/webgate/apache/oamssso/logout.html`

Where:

**WebGate\_install\_dir** is the directory where the WebGate is installed. Ensure that the name of the logout page contains the string `logout`.

8. Ensure that the user ID that is returned by the `OAM_REMOTE_USER` header variable exists in the user management data sources for SAP Enterprise 7.4.
9. On the Launch Pad page, go to the **Access Manager** section and click **Authentication Schemes**.

Choose the authentication scheme to use. This is the scheme that you selected inside the application domain of the WebGate.

### 62.5.3 Configuring Apache Web Server 2.0.x or 2.2.x

You can configure a proxy to access SAP Enterprise Portal 7.4.

To configure:

1. Set up the Apache proxy in non-SSL mode or in SSL mode. Refer to the Apache documentation for details.

If HTTPS communication is used with the SAP Enterprise Portal 7.4, use SSL mode.

2. To enable the proxy to the SAP Enterprise Portal 7.4, add the following to the `httpd.conf` file:

```
ProxyRequests Off
ProxyPass /http://sap_host:port/
ProxyPassReverse / http://sap_host:port//
ProxyPreserveHost On
```

Where:

**sap\_host** - The name of the machine hosting the SAP Enterprise Portal 7.4 instance

**port** - The listening port for the SAP Enterprise Portal 7.4 instance.

This set of directives specifies that all requests to the Web server that take the form `http://apache_host:port/irj` or `https://apache_host:port/irj` are redirected to `http://sap_host:port/irj` or `https://sap_host:port/irj`.

3. Uncomment the following proxy related modules:
  - `LoadModule proxy_module modules/mod_proxy.so`
  - `LoadModule proxy_http_module modules/mod_proxy_http.so`
4. Restart the proxy Web server.
5. Open a browser and access the following URL:
  - Non-SSL: `http://apachehost:port/irj`
  - SSL: `https://apachehost:port/irj`

This request should be redirected to the SAP Enterprise Portal 7.4 login ID.

6. Log in using the SAP Enterprise Portal 7.4 administrator login ID.

Verify that you can perform the provided administrative functions when logged in as an administrator.
7. Log in as a non-administrative user.

Verify that you can perform the provided non-administrative functions when logged in.

## 62.5.4 Configuring SAP Enterprise Portal 7.4 for External Authentication

You can enable external authentication in SAP Enterprise Portal 7.4 using the `OAM_REMOTE_USER` header variable.

See the *SAP Enterprise Portal 7.4 Enterprise Postal Security Guide* for more information about configuring authentication schemes for SAP Enterprise Portal.

1. To enable logout from a single sign-on session in both SAP Enterprise Portal 7.4 and Access Manager, use the SAP NetWeaver Administrator interface to configure a logout URL.

Set the SAP NetWeaver Portal Logoff URL (`ume.logoff.redirect.url`) to the appropriate logout URL.

- Open the config tool by running the `configtool.bat` file, which is located here:

```
SAP_J2EE_engine_install_dir\configtool
```

Prepare to edit the configuration by switching to configuration editor mode, and choosing edit mode.

- Edit the properties for the following workernode service:

```
com.sap.security.core.ume.service
```

Update the `ume.logoff.redirect.url` property and the `ume.logoff.redirect.silent` property with the logoff URL configured in step 1.

```
ume.logoff.redirect.url=http(s)://proxy_host:port/logout.html
```

```
ume.logoff.redirect.silent=false
```

Save your changes and close the config tool.

- Stop the SAP J2EE dispatcher and server.

## 62.5.5 Adjusting the Login Module Stacks for Using Header Variables

You can use the NetWeaver Admin console to add the `HeaderVariableLoginModule` to the appropriate login module stack or template and configure the options.

In the console, choose **Configuration > Authentication and Single Sign-On**. Click **Login Modules** under the **Authentication** tab. Create the `HeaderVariableLoginModule` login module, with the display name as `HeaderVariableLoginModule` and class name as `com.sap.security.core.server.jaas.HeaderVariableLoginModule`. Choose **Component > ticket** from the **Login Module Use** tab, and add the login module `HeaderVariableLoginModule` to the login module stack for each template or application that is to support header variable authentication.

**Table 62-2 Login Module Stacks for using Header Variables**

Login Modules	Flag	Options
EvaluateTicketLoginModule	SUFFICIENT	{ume.configuration.active=true}
HeaderVariableLoginModule	OPTIONAL	{ume.configuration.active=true, Header=<header_name>}
CreateTicketLoginModule	SUFFICIENT	{ume.configuration.active=true}
BasicPasswordLoginModule	REQUISITE	{}
CreateTicketLoginModule	OPTIONAL	{ume.configuration.active=true}

## 62.6 Testing the Integration

You can validate the front-end and back-end integrations. using web browser.

### Front-End Integration Test Procedure

Follow these steps to test the integration using a Web browser.

1. Open a protected URL. For example: `https://host:port/irj`  
Access Manager should prompt for authentication (either form based, or basic authentication over LDAP, or Cert Mode authentication).
2. Enter the correct user credentials.  
If the credentials are correct, you will be logged into the SAP NetWeaver Enterprise Portal system.

### Back-End Integration Test Procedure

To use these steps, download and install a plug-in for your Web browser that displays the HTTP requests and responses that happen when your browser requests a resource. Live HTTP Headers for Firefox, or ieHTTPHeaders for Internet Explorer are two such plug-ins.

1. Open the plug-in and type a URL in your browser to request a protected resource, for example: `https://host:port/irj`

The plug-in window will be populated with the HTTP requests and responses.

2. Analyze the requests and responses and make sure that each request returns a response without errors.

Once the user is authenticated you should see some sessions and cookies set in the HTTP Header logs. The cookies that are set include the following:

- ObSSOCookie
- JSESSIONID
- OAM\_ID
- OAM\_REQ

When the request reaches the SAP NetWeaver Enterprise Portal, you will receive responses from the Enterprise Portal system in the header logs.

## 62.7 Troubleshooting the Integration

You can troubleshoot issues with this integration.

**Problem:** The browser has problems displaying the SAP 7.0.x administration interface through the proxy server. You may receive an "object not found" error and related JavaScript errors.

**Solution:** See the following SAP document for a list of supported browsers, "[SAP NetWeaver 7.0.x Product Availability Matrix](#)."



---

# Integrating Oracle Access Manager with SAP NetWeaver Enterprise Portal Using OpenSSO Policy Agent 2.2

You can use Sun Java System Access Manager / OpenSSO Policy Agent 2.2 to integrate Oracle Access Manager 11.1.2 with SAP NetWeaver Enterprise Portal 7.01.

This chapter covers the following topics:

- [What is Supported in This Release?](#)
- [Registering the OpenSSO Agent](#)
- [Installing the OpenSSO Policy Agent 2.2 on SAP Enterprise Portal](#)
- [Deploying the Agent Software Delivery Archive](#)
- [Making a Class Loader Reference to the Login Module](#)
- [Modifying the SAP Enterprise Portal 7.0 / Web Application Server 7.0 Class Path](#)
- [Deploying and Starting the Agentapp.war File](#)
- [Using Telnet to Create a Reference Between agentapp and Library AmSAPAgent2.2](#)
- [Adding the Login Module to the Stack](#)
- [Modifying the Login Module Stack](#)
- [Updating the ume.logoff.redirect.uri](#)
- [Configuring the AMAgent.properties File](#)
- [Testing the Integration](#)

## 63.1 What is Supported in This Release?

Only SAP Netweaver Enterprise Portal 7.01 is supported by the OpenSSO Policy Agent 2.2 in this release. MySAP is not certified.

The following patch must be applied to the OpenSSO Policy Agent 2.2:

```
PSE ID: OpenSSO.J2EE.PSE.2.2.18810674
```

SAP single sign-on will not work without this patch.

## 63.2 Registering the OpenSSO Agent

You can register the OpenSSO Agent.

Before you begin, complete the following steps:

- Remotely register the agent so that the Agent Profile is created on the Oracle Access Management side. Use the remote registration tool on the OAM server located here:

```
<Middleware_Home>/Oracle_IDM1/oam/server/rreg
```

- Ensure that the fully-qualified domain name of the OAM server and the SAP server are updated in the `hosts` file on both systems.

Always use the SAP and OAM server's fully-qualified domain name while installing or registering the agent and doing OAM configuration.

1. Open the appropriate XML request file for editing. The request file will provide inputs for the registration.

Request files are located inside the input folder.

2. Modify the specific values to match your environment.

```
<?xml version="1.0" encoding="UTF-8"?>
<!-- Copyright (c) 2009, 2013, Oracle and/or its affiliates. All rights reserved.
NAME: OpenSSORequest.xml - Template (with all options) for OpenSSO Agent Registration Request
file
DESCRIPTION: Modify with specific values and pass file as input to the tool-->
<OpenSSORegRequest>
 <serverAddress>http://OAMserver.example.com:7001</serverAddress>
 <hostIdentifier>OPENSSO_HOSTID8</hostIdentifier>
 <agentName>OPENSSO_SAP8</agentName>
 <agentBaseUrl>http://SAPserver.example.com:50000</agentBaseUrl>
 <applicationDomain>OPENSSO_APPDOMAIN</applicationDomain> //Modify this.
 <autoCreatePolicy>true</autoCreatePolicy>
 <agentType>J2EE</agentType>
 <agentVersion>2.2</agentVersion> //Important: Make sure the version is 2.2.
 <agentDebugDir></agentDebugDir>
 <agentAuditDir></agentAuditDir>
 <agentAuditFileName></agentAuditFileName>
 <protectedAuthnScheme></protectedAuthnScheme>
</OpenSSORegRequest>
```

3. To register the agent, open a command prompt and run the following command from the `bin` directory in the `rreg` tool:

```
oamreg.sh inband input/OpenSSORequest
```

The command outputs the `AMAgent.properties` file, which is located in the output directory.

---

**Note:**

For OpenSSO agent 2.2, there is only one output file (`AMAgent.properties`), whereas for OpenSSO agent 3 there are two output files (`OpenSSOAgentBootstrap.properties` and `OpenSSOAgentConfiguration.properties`).

---

This registration creates a footprint in the `oam-config.xml` file for the OAM domain, which is located here:

```
<Middleware_home>/user_projects/domains/base_domain1/config/
fmwconfig/oam-config.xml
```

The registered agent is in an entry similar to the following:

```
<Setting Name="<Agent_Name>" Type="htf:map">
```

The registration process is now complete.

## 63.3 Installing the OpenSSO Policy Agent 2.2 on SAP Enterprise Portal

You can install the agent on the SAP container.

1. Extract the OpenSSO Policy agent and navigate to the bin folder.
2. Open a command prompt and type the following command to install the agent on the SAP container.

```
agentadmin.sh - -install
```

The command will prompt you for values as needed. The following table summarizes the requested inputs.

**Table 63-1**

Request prompt	Sample Input	Description
SAP <SID> Directory	<SAP_Server_Inst ance> \JC00\j2ee \cluster \server0	Path to the SAP directory
Agent installed on WebAS domain	false	
Access Manager Services host	OAMserver.examp le.com	OAM server fully-qualified domain name
Access Manager Services Port	8003	Port where the OAM server is running
Access Manager Services protocol	http	
Access Manager Services deployment URI	/opensso	OpenSSO proxy URL
Agent host name	SAPserver.examp le.com	SAP server fully-qualified domain name
Application server instance port number	50000	Port where the SAP EP server is running
Protocol for Application Server instance	http	

**Table 63-1 (Cont.)**

Request prompt	Sample Input	Description
Deployment URI for the Agent Application	/agentapp	URI of the WAR file that we deploy
Encryption key	gSwxyctnKWkx8fBg bwj8Mn5ziksjaUqi	
Agent profile name	OPENSSO_SAP8	Agent profile name given during registration
Agent profile password file name	/Policy_Agent/ sap_v7_agent/ Info/p.txt	

### 63.3.1 Post-Installation Steps

After installation, an agent instance is created on the SAP container.

Inside this directory is another instance of the `AMAgent.properties` file. (So there are two `AMAgent.properties` files: one generated during remote registration, and one generated just previously during the Agent installation.)

1. Compare the two properties files and consolidate them so that you have one properties file that contains all of the information.

Be sure that all of the settings in the `AMAgent.properties` file matches the Agent Profile entry in the `oam-config.xml` file on the OAM server.

2. In `oam-config.xml`, add the following entry under the `<Setting Name="NamingData" Type="htf:map">` element:

```
<Setting Name="iplanet-am-platform-server-id" Type="xsd:string">serverprotocol://serverhost:serverport</Setting>
```

---



---

**Note:**

Be sure to increment the version integer every time you update the `oam-config.xml` file:

```
<Setting Name="Version" Type="xsd:integer">113</Setting>
```

---



---

## 63.4 Deploying the Agent Software Delivery Archive

You can deploy the Agent Software Delivery Archive.

1. Go to the `etc` folder in the agent to locate the `AmSAPAgent2.2.sda` archive. The `.sda` file is a library that you will deploy onto the SAP server using the Software Deployment Manager (SDM).
2. Use the Software Deployment Manager (`/usr/sap/SID/InstanceName/SDM/program/RemoteGui.sh`) to deploy the `AmSAPAgent2.2.sda` file. Refer to the SAP documentation for details.

Once the deployment is complete, verify that the library is deployed by viewing the **Undeployment** tab. The `AmSAPAgent2.2` library should be listed.

You can also use the SAP Visual Administrator tool (`/usr/sap/SID/InstanceName/j2ee/admin/go.sh`) to verify that the deployed library, along with the SAP-dependent libraries, are available in the container.

## 63.5 Making a Class Loader Reference to the Login Module

Use the SAP Visual Administrator tool (`/usr/sap/SID/InstanceName/j2ee/admin/go.sh`) to make a class loader reference for the newly deployed library.

Add the reference to the `LoginModuleClassLoader` by adding the following key-value pair on the **Properties** tab on the Security Provider configuration page (Server Instance > Services > Security Provider).

**Table 63-2**

Key	Value
<code>LoginModuleClassLoader</code>	<code>library: AmSAPAgent2.2</code>

## 63.6 Modifying the SAP Enterprise Portal 7.0 / Web Application Server 7.0 Class Path

You can modify the SAP Enterprise Portal 7.0 / Web Application Server 7.0 Class Path.

Open the SAP Config Tool (`/usr/sap/SID/InstanceName/j2ee/configtool/configtool.sh`), navigate to `Cluster_data > Instance ID > Server instance`, and on the **General** tab, add the following paths to the **Classpath** field:

```
/Policy_Agent/sap_v7_agent/j2ee_agents/sap_v7_agent/
<Agent_Instance>/config
```

```
/Policy_Agent/sap_v7_agent/j2ee_agents/sap_v7_agent/locale
```

## 63.7 Deploying and Starting the Agentapp.war File

You can deploy and start the `Agentapp.war` file.

1. Open the SAP Deployment Manager (`deploy.sh`) and create a new project.
2. Go to an empty directory owned by the SAP instance user (`j2eeadm`) and type `agentapp` for the address field.

Go to the Assembler tab and add the `agentapp.war` archive (right-click the `agentapp` node and select **Add Archive** from the context menu).

Save the project.

Browse to the directory specified previously as owned by the SAP Instance user (`j2eeadm`), type `agentapp` for the address field, and click OK.

Right-click the `agentapp` root node and select **Make Ear** from the context menu.

## 63.8 Using Telnet to Create a Reference Between agentapp and Library AmSAPAgent2.2

You can use Telnet to create a reference between `agentapp` and library `AmSAPAgent2.2`.

1. Telnet to the SAP host (for example, `saphost.example.com 50008`) and log on as an administrator.
2. Issue the following commands:
  - a. `$ jump 0`  
The system returns a message similar to the following:  
`You jumped on node 4503950.`
  - b. `$ add deploy`
  - c. `$ CHANGE_REF -m sap.com/agentapp library:AmSAPAgent2.2`  
The system returns the following message:  
`The reference between application sap.com/agentapp and library:AmSAPAgent2.2 was made!`
3. Stop and Start the SAP Enterprise Portal instance.

---

---

**Note:**

You can also use the SAP Visual Administrator tool (`/usr/sap/SID/InstanceName/j2ee/admin/go.sh`) to verify that the references were made properly. Choose **Server Instance > Services > ClassLoader Viewer**.

---

---

## 63.9 Adding the Login Module to the Stack

You can the Login Module to the stack.

Before You Begin - Start the SAP Enterprise Portal instance if it is not running.

1. Start the SAP Visual Administrator tool and log in. (`/usr/sap/SID/InstanceName/j2ee/admin/go.sh`).
2. Select the **Security Provider** service, click the **User Management** tab, and switch to edit mode.
3. Click **Manage Security Stores > Add Login Module**.

Click OK when the dialog box opens.

4. In the **Class Name** field, type the following:  
`com.sun.identity.agents.sap.v70.AmSAPEP70LoginModule`
5. In the **Display Name** field, type the following:  
`AmSAPEP70LoginModule`

## 63.10 Modifying the Login Module Stack

You can modify the Login Module Stack.

1. Start the SAP Visual Administrator tool and log in. (`/usr/sap/SID/InstanceName/j2ee/admin/go.sh`).
2. Select the **Security Provider** service, click the **Policy Configurations** tab, and switch to edit mode.

3. In the **Components** list, select the **ticket** authentication template.
4. Delete all login modules *except for* the following:
  - `com.sap.security.core.server.jaas.EvaluateTicketLoginModule`
  - `com.sap.security.core.server.jaas.CreateTicketLoginModule`
5. Click **Add New** and select **AmSAPEP70LoginModule** from the list of modules.
6. Click **Modify** and move `AmSAPEP70LoginModule` between the two remaining login modules.

The new ticket authentication template should match the values in the following table.

**Table 63-3 Ticket Authentication Values**

Login Module	Flag
<code>EvaluateTicketLoginModule</code>	SUFFICIENT
<code>AmSAPEP70LoginModule</code>	REQUISITE
<code>CreateTicketLoginModule</code>	OPTIONAL

## 63.11 Updating the ume.logoff.redirect.uri

You can update the `ume.logoff.redirect.uri`.

1. Open the SAP Config Tool (`/usr/sap/SID/InstanceName/j2ee/configtool/configtool.sh`) and switch to edit mode.
2. Click the pencil and glasses button and choose **cluster\_data > server > cfg > services**.

The UME service property sheet opens.

3. Open the `com.sap.security.core.ume.service` property sheet and add the following custom value to the `ume.logoff.redirect.uri` property.

```
http://OAM-Server-Hostname:OAM-Port/oam/server/logout
```

## 63.12 Configuring the AMAgent.properties File

You can configure the `AMAgent.properties` file.

Open the `AMAgent.properties` file for the Agent Instance and edit the following properties:

---

**Note:**

The following properties in `AMAgent.properties` must match the properties in `oam-config.xml`. If the properties do not match, update the properties in `oam-config.xml`.

Be sure to increment the version integer every time you update the `oam-config.xml` file:

```
<Setting Name="Version" Type="xsd:integer">113</Setting>
```

---

1. In **Debug Service Properties**, update the complete path of the log location similar to the following:

```
com.iplanet.services.debug.directory = /Policy_Agent/
sap_v7_agent/j2ee_agents/sap_v7_agent/Agent_003/logs/debug
```

2. In **COMMON ATTRIBUTE FETCH PROCESSING PROPERTIES**, set `cookie.encode` to `false`.

```
com.sun.identity.agents.config.attribute.cookie.encode =
false
```

3. In **COOKIE RESET PROCESSING PROPERTIES**, edit the following properties:

```
com.sun.identity.agents.config.cookie.reset.enable = true
com.sun.identity.agents.config.cookie.reset.name[0] =
MYSAPSSO2
com.sun.identity.agents.config.cookie.reset.domain[MYSAPSSO2]
= .corp.example.com
```

4. In **URL DECODE SSO TOKEN FLAG**, set `decode` to `false`:

```
com.sun.identity.agents.config.sso.decode = false
```

5. In **FILTER OPERATION MODE**, add or update the following property:

```
com.sun.identity.agents.config.filter.mode = SSO_ONLY
```

## 63.13 Testing the Integration

Users in the Oracle Access Management user store should also be in the SAP server. Be sure to allow user access in OAM. You can verify that the integration is working properly.

To verify:

1. Access the protected URL (for example, `/irj`).

You should be redirected to the Oracle Access Manager login form.

2. Enter a valid user name and password.

You should be authenticated and logged into the SAP server (`/irj`).



# Part XVI

---

## Appendixes

Part XII provides information that is outside the scope of day-to-day administration tasks with Oracle Access Management.

Part XII contains the following appendixes:

- [Integrating Oracle ADF Applications with Access Manager SSO](#)
- [Internationalization and Multibyte Data Support for 10g WebGates](#)
- [Securing Communication](#)
- [Reviewing Bundled, Generated, and Migrated Artifacts](#)
- [Troubleshooting](#)



---

# Integrating Oracle ADF Applications with Access Manager SSO

The Oracle Application Developer Framework (ADF) and applications that are coded to Oracle ADF standards interface with the OPSS SSO Framework. The Oracle Platform Security Services (OPSS) single sign-on framework provides a way to integrate applications in a domain with a single sign-on (SSO) solution.

You can integrate a Web application that uses Oracle ADF security and the OPSS SSO Framework with an Access Manager SSO security provider for user authentication, as described in the following topics:

- [Introducing Oracle Platform Security Services and Oracle Application Developer Framework](#)
- [Integrating Access Manager With Web Applications Using Oracle ADF Security and the OPSS SSO Framework](#)
- [Configuring Centralized Logout for Oracle ADF-Coded Applications](#)
- [Confirming Application-Driven Authentication During Runtime](#)

## A.1 Introducing Oracle Platform Security Services and Oracle Application Developer Framework

Oracle Application Development Framework provides the ADF Security framework. ADF Security is built on top of the Oracle Platform Security Services (OPSS) architecture, which in turn incorporates the Java Authentication and Authorization Service (JAAS) and Java EE container-managed security.

You need to familiarize yourself with the following topics:

- [Oracle Platform Security Services Single Sign-on Framework](#)
- [Oracle Application Developer Framework](#)

### A.1.1 Oracle Platform Security Services Single Sign-on Framework

A single sign-on (SSO) solution must provide a standard way for applications to login and logout users. After successful authentication, the SSO service is responsible to redirect the user to the appropriate URL.

The Oracle Platform Security Services (OPSS) SSO Framework provides a way to integrate applications in a domain with an SSO solution. Specifically, it provides applications with a common set of APIs across SSO products to handle login, auto login, and logout.

The Oracle Application Developer Framework (ADF) and applications that are coded to Oracle ADF standards interface with the OPSS SSO Framework. For more information about Oracle ADF.

See [Oracle Application Developer Framework](#).

The Access Manager SSO solution is available out-of-the-box and provides the following to applications that are coded to Oracle ADF standards and the OPSS SSO Framework:

- Login (application-driven): Upon accessing a part of a secured artifact that requires authentication, the application triggers authentication and redirects the user to be authenticated by the appropriate solution.
- Auto login: A user who has initially accessed an application anonymously registers an account with the application (Oracle Identity Manager, for instance); upon a successful registration, the user is redirected to the authentication URL; the user can also be automatically logged in without being prompted.
- Global logout: When a user logs out of one application, the logout propagates across to any other application that is enabled by the solution.

---

---

**Note:**

The OPSS SSO framework does not support multi-level authentication.

---

---

**See Also:**

*Securing Applications with Oracle Platform Security Services* part "Single Sign-On Configuration" for more information about choosing an SSO solution, and the Access Manager solutions.

---

---

## A.1.2 Oracle Application Developer Framework

The Oracle Application Development Framework is an end-to-end application framework that builds on Java EE standards and open-source technologies to simplify and accelerate implementing service-oriented applications.

The development and run-time environment required to deploy and manage ADF applications is similar in many ways to the environment required for other Java EE applications.

The difference between a typical Java EE environment and an environment that supports Oracle ADF applications is the availability of the Oracle ADF run-time libraries:

- In Oracle Fusion Middleware 11g, an Oracle WebLogic Server domain, by default, does not contain the Oracle ADF run-time libraries. However, you can optionally configure or extend your domain to include the Java Run-time Files (JRF). The Oracle ADF run-time libraries are included as part of the JRF component.

The Oracle WebLogic Server domain can be extended with the Java Run-time Files (JRF) domain template, which includes the required Oracle ADF libraries, and other important Oracle-specific technologies.

- In Oracle Application Server 10g, each instance of OC4J automatically provided the Oracle ADF run-time libraries required to support Oracle ADF applications.

For information about the types of Java EE environments available in 10g and instructions for upgrading those environments to Oracle Fusion Middleware 11g, refer to the *Oracle Fusion Middleware Upgrade Guide for Java EE*.

## A.2 Integrating Access Manager With Web Applications Using Oracle ADF Security and the OPSS SSO Framework

This section describes how to integrate a Web application that uses Oracle ADF security and the OPSS SSO Framework with an Access Manager SSO security provider for user authentication.

Before the Web application can be run, you must configure the domain-level `jps-config.xml` file on the application's target Oracle WebLogic Server for the Access Manager security provider.

The domain-level `jps-config.xml` file is in the following path and should not be confused with the deployed application's `jps-config.xml` file:

```
$DOMAIN_HOME/config/fmwconfig/jps-config.xml
```

---

**Note:**

Do not confuse the domain-level `jps-config.xml` file with the deployed application's `jps-config.xml` file.

---

You can use an Oracle JRF WLST script to configure the domain-level `jps-config.xml` file, either before or after the Web application is deployed. This Oracle JRF WLST script is named as follows:

**Linux:** `wlst.sh`

**Windows:** `wlst.cmd`

The Oracle JRF WLST script is available in the following path if you are running through JDev:

```
$JDEV_HOME/oracle_common/common/bin/
```

In a standalone JRF WebLogic installation, the path is:

```
$MW_HOME/oracle_common/wlst
```

---

**Note:**

The Oracle JRF WLST script is required. When running WLST for Oracle Java Required Files (JRF), do **not** use the WLST script under `$JDEV_HOME/wlserver_10.3/common/bin`.

---

### Command Syntax

```
addOAMSSOProvider(loginuri, logouturi, autologinuri)
```

Run the `addOAMSSOProvider` command as in the following example.

```

cd $MW_HOME/oracle_common/common/bin

./wlst.sh

.....after running ./wlst.sh.....
Welcome to WebLogic Server Administration Scripting Shell
Type help() for help on available commands

addOAMSSOProvider(loginuri="/${app.context}/adfAuthentication",
 logouturi="/oamssso/logout.html", autologinuri="/obrar.cgi")
addOAMSSOProvider(loginuri="/testapp/adfAuthentication",
 logouturi="/oamssso/logout.html", autologinuri="/obrar.cgi")
wls:/offline> addOAMSSOProvider(loginuri="/${app.context}/adfAuthentication",
logouturi="/oamssso/logout.html", autologinuri="/obrar.cgi")

```

Table A-1 defines the expected value for each argument.

**Table A-1 addOAMSSOProvider Command-line Arguments**

Argument	Definition
loginuri	<p>Specifies the URI of the login page</p> <p><b>Note:</b> For ADF security enabled applications, "<code>&lt;context-root&gt;/adfAuthentication</code>" should be provided for the 'loginuri' parameter. Here is the flow:</p> <ol style="list-style-type: none"> <li>1. User accesses a resource that has been protected by authorization policies in OPSS, for example.</li> <li>2. If the user is not yet authenticated, ADF redirects the user to the URI configured in 'loginuri'.</li> <li>3. Access Manager, should have a policy to protect the value in 'loginuri': for example, "<code>&lt;context-root&gt;/adfAuthentication</code>".</li> <li>4. When ADF redirects to this URI, Access Manager displays a Login Page (depending on the authentication scheme configured in Access Manager for this URI).</li> </ol>
logouturi	<p>Specifies the URI of the logout page</p> <p><b>Note:</b> For ADF security enabled applications, logouturi should be configured based on logout guidelines in <a href="#">Configuring Centralized Logout for Sessions Involving 11g WebGates</a>. For the:</p> <ul style="list-style-type: none"> <li>• 11g WebGate the value of the logouturi should be sought from the 11g WebGate Administrator.</li> <li>• 10g WebGate requires a logouturi value of <code>/oamssso/logout.html</code></li> </ul>
autologinuri	Specifies the URI of the autologin page.

The procedure to configure domain-level `jps-config.xml` for a Fusion Web application with Oracle ADF Security enabled is part of a larger task. With the exception of the command syntax, all tasks are the same for Access Manager 10g and 11g.

See:

- [Sample SSO Configuration for Access Manager](#)
- [SSO Provider Configuration Details](#)

---

---

**See Also:**

- *Oracle Fusion Middleware Oracle WebLogic Scripting Tool*
  - *WLST Command Reference for WebLogic Server*
- 
- 

## A.2.1 Sample SSO Configuration for Access Manager

The SSO service configuration entered with the procedure described in *Securing Applications with Oracle Platform Security Services* for all tasks involving Access Manager SSO providers and an OAM Configuration Example is written to the file `jps-config.xml`. The data specified includes:

- A particular SSO service
- The auto-login and auto-logout URIs
- The authentication level
- The query parameters contained in the URLs returned by the selected SSO service
- The appropriate settings for token generation

The following fragment of a `jps-config.xml` file illustrates the configuration of an Access Manager SSO provider. Some values are merely placeholders for actual content. Your configuration should contain values for your implementation.

---

---

**See Also:**

["SSO Provider Configuration Details"](#)

---

---

### Sample SSO Configuration for Access Manager

```
<propertySets>
 <propertySet name = "props.auth.url">
 <property name = "login.url.BASIC" value = "http://host:port/oam_login.cgi?
level=BASIC"/>
 <property name = "login.url.FORM" value = "http://host:port/oam_login.cgi?
level=FORM"/>
 <property name = "login.url.DIGEST" value = "http://host:port/oam_login.cgi?
level= DIGEST"/>
 <property name = "autologin.url" value = " http://host:port/obrar.cgi"/>
 <property name = "logout.url" value = "http://host:port/logout.cgi"/>
 <property name = "param.login.successurl" value = "successurl"/>
 <property name = "param.login.cancelurl" value = "cancelurl"/>
 <property name = "param.autologin.targeturl" value = "redirectto"/>
 <property name = "param.autologin.token" value = "cookie"/>
 <property name = "param.logout.targeturl" value = "targeturl"/>
 </propertySet>

 <propertySet name="props.auth.uri">
 <property name="login.url.BASIC" value="/${app.context}/adfAuthentication?
level=BASIC" />
 <property name="login.url.FORM" value="/${app.context}/adfAuthentication?
level=FORM" />
 <property name="login.url.DIGEST" value="/${app.context}/adfAuthentication?
level=DIGEST" />
 </propertySet>
```

```
<property name="autologin.url" value="/obrar.cgi" />
<property name="logout.url" value="/${oamssso/logout.html" />
</propertySet>

<propertySet name = "props.auth.level">
 <property name = "level.anonymous" value = "0"/>
 <property name = "level.BASIC" value = "1"/>
 <property name = "level.FORM" value = "2"/>
 <property name = "level.DIGEST" value = "3"/>
</propertySet>
</propertySets>

<serviceProviders>
 <serviceProvider name = "sso.provider"
 class = "oracle.security.jps.internal.sso.SsoServiceProvider"
 type = "SSO">
 <description>SSO service provider</description>
 </serviceProvider>
</serviceProviders>

<serviceInstances>
 <serviceInstance name = "sso" provider = "sso.provider">
 <propertySetRef ref = "props.auth.url"/>
 <propertySetRef ref = "props.auth.level"/>
 <property name = "default.auth.level" value = "2"/>
 <property name = "token.type" value = "OAMSSOToken"/>
 <property name = "token.provider.class" value =
"oracle.security.wls.oam.providers.sso.OAMSSOServiceProviderImpl"/>
 </serviceInstance>
</serviceInstances>

<jpsContexts default = "default">
 <jpsContext name = "default">
 <serviceInstanceRef ref = "sso"/>
 </jpsContext>
</jpsContexts>
```

## A.2.2 SSO Provider Configuration Details

Note the following important points:

- Any SSO provider must define the URI for at least the FORM login with the property `login.url.FORM`. The value need not be a URL.
- If the application supports a self-registration page URI or URL, it must be specified with the property `autologin.url`.
- If the SSO solution supports a global logout URI or URL, it must be specified with the property `logout.url`. The OAM solution supports global logout.
- The following properties, illustrated in Example A-1, are optional:
  - `param.login.successurl`
  - `param.login.cancelurl`
  - `param.autologin.targeturl`
  - `param.login.token`



- `param.logout.targeturl`
- The use of the variable `app.context` in URI specifications, in values within the property set `props.auth.uri` for instance, is allowed for only ADF applications when integrating with the Access Manager solution.
- The property set `props.auth.level` is required.
- The reference to `props.auth.url` is required.
- The property `sso.provider.class` within a service instance of the SSO provider is the fully qualified name of the class implementing a specific SSO solution.

In the case of the OAM solution, the provided class name is `oracle.security.wls.oam.providers.sso.OAMSSOServiceProviderImpl`.

- The property name `default.auth.level` within a service instance of the SSO provider must be set to "2", as illustrated in Example A-1.
- The property `token.type` within a service instance of the SSO provider is required.

This token type identifies the token set on the HTTP request by the SSO provider upon a successful authentication; the SSO provider uses this token, after the first time, to ensure that the user does not need to be reauthenticated and that his sign-on is still valid. In the case of the OAM solution, the token type must be `OAMSSOToken`, as illustrated in Example A-1.

- The property `token.provider.class` within a service instance of the SSO provider is the fully qualified name of the token class, and it is provider-specific.
- An application that implements a self-registration logic and wants to auto login a user after successful self-registration, it must call the OPSS `autoLogin` API; in turn, to allow this call, it must grant that application a code source permission named `CredentialMapping` with class `JpsPermission`.

The following fragment of the file `system-jazn-data.xml` illustrates the specification of this permission to the application `MyApp`:

```
<grant>
 <grantee>
 <codesource>
 <url>file:${domain.home}/servers/MyApp/-</url>
 </codesource>
 </grantee>
 <permissions>
 <permission>
 <class>oracle.security.jps.JpsPermission</class>
 <name>CredentialMapping</name>
 </permission>
 </permissions>
</grant>
```

## A.3 Configuring Centralized Logout for Oracle ADF-Coded Applications

The Access Manager SSO solution is available for applications that are coded to Oracle ADF standards and the OPSS SSO Framework. ADF-coded applications that are

configured to perform logout with Access Manager, redirect to the `/oamssso/logout.html` resource.

IAMSuiteAgent intercepts and processes the request, cleans up the session, redirects to the central logout page (done by the OAM Server) and redirects back to the `end_url`.

---

---

**See Also:**

*Securing Applications with Oracle Platform Security Services*

---

---

**Note:**

For ADF applications, only one extra configuration step is needed (to configure the OAMSSOProvider for OPSS).

---

---

Task overview: Protecting ADF-coded applications with Access Manager

1. Review the following topic:

See [Centralized Logout Processing for Applications Coded to Oracle ADF Standards](#).

2. Protect the ADF-coded application using either an:

- 11g Webgate
- 10g Webgate

3. Perform the single extra configuration step for ADF-coded applications: configure the OAMSSOProvider.

See [Configuring Centralized Logout for ADF-Coded Applications with Access Manager](#).

4. Perform logout configuration steps for your chosen Webgate version.

### A.3.1 Centralized Logout Processing for Applications Coded to Oracle ADF Standards

ADF-coded applications refer to either applications that have been fully integrated with ADF or those that simply use ADF Authentication Servlet to integrate with OPSS.

In this case, logout is initiated when an ADF application causes the invocation of the logout URI. The following process overview outlines the Access Manager centralized logout process for applications coded to Oracle ADF standards.

Process overview: Centralized logout for ADF applications with 10g Webgate

1. An ADF application causes the invocation of the following URI.

```
/<application context root>/adfAuthentication?logout=true&end_url=<any uri>
```

The `end_url` parameter specifies the URI to which the application returns control following logout.

2. ADF invokes the configured OPSS SSO provider (OAM in this case) and delegates the logout functionality to the configured logout URI by redirecting the request to

the logout URI. The `end_url` value is passed as a query string to the logout URI. For example: `/oamssso/logout.html?end_url=<end_uri>`.

3. The logout URI is invoked on the Webgate front-ending the application.
4. 10g Webgate clears the `ObSSOCookie` for its domain and loads the `logout.html` script.
5. If the `end_url` parameter does not include `host:port`, the `logout.html` script gets the `host:port` of the local server and constructs the `end_url` parameter as a URL. For example:

```
http://serverhost:port/oam/server/logout?end_url=http://my.site.com/welcome.html
```

6. Logic in `logout.html` redirect to the OAM Server. For example:

```
http://myoamserverhost:port/oam/server/logout?end_url=http://my.site.com/welcome.html
```

7. The OAM Server executes logout as follows:
  - a. Cleans up the session information associated with the user at the server side.
  - b. Validates the `end_url` and sends a page with callback URLs to the user's browser.

---



---

**Note:**

The Logout Callback URL is specified in the expanded (not short) OAM Agent registration, as described in [Table 15-3](#).

---



---

- c. From the callback page, a new request is initiated to a specific URI on each Webgate. When this request reaches the specific Webgate in the specific domain, the `ObSSOCookie` for that domain is cleared.
- d. The user is redirected to the `end_url` in the logout script. However, if the `end_url` parameter is not present, an appropriate message is sent by the OAM Server.

### A.3.2 Configuring Centralized Logout for ADF-Coded Applications with Access Manager

The following procedure is similar to configuring logout for 10g Webgates, with specific step for ADF-coded applications. The ADF-coded application must send the `end_url` value to identify where to redirect the user after logout processing. However, with ADF-coded applications, logout occurs when the application causes the following URI to be invoked:

```
/<app context root>/adfAuthentication?logout=true&end_url=<any uri>
```

---



---

**Note:**

The `Appcore f/w` could facilitate triggering of the above URL and the ADF application could leverage that.

---



---

Some steps in this procedure require the WebLogic Scripting Tool (WLST): `wlst.sh` (Linux) or `wlst.cmd` (Windows), which you must invoke from the `WLST_install_dir`.

---



---

**See Also:**

- "Using Custom WLST Commands" in the *WLST Command Reference for WebLogic Server*
- 
- 

To configure centralized logout for ADF-coded applications

1. Check with the Administrator to confirm the location of the `logout.html` script configured with the agent, which you need in following steps.
2. Configure OPSS for OAM as the SSO provider to update `jps-config.xml` for the WebLogic administration domain, as follows:

- a. On the computer hosting the Oracle WebLogic Server and the Web application using Oracle ADF security, locate the Oracle JRF WLST script. For example:

```
cd $ORACLE_HOME/oracle_common/common/bin
```

- b. Connect to the computer hosting the Oracle WebLogic Server, enter the Administrator ID and password, and the host and port of the WebLogic AdminServer:

```
wls:/> /connect('admin_ID', 'admin_pw', 'hostname:port')
```

For example, the Oracle WebLogic Administration Server host could be `localhost` using port 7001. However, your environment might be different.

- c. Check with the Administrator to confirm the location of the `logout.html` script configured with the agent.

In Step d, you must use the value provided by the Administrator. Here, `logouturi` value is the URI of the logout script `/logout.html`. The value could either begin with "logout." (exceptions are `logout.gif` and `logout.jpg`) or it could be any other value configured by the Administrator.

- d. Enter the `loginuri` for ADF authentication and the `logouturi` (location of the `logout.html` script configured with the agent); the host and port are not needed.

```
wls:/>addOAMSSOProvider(loginuri="/${app.context}/adfAuthentication",
logouturi="/oamssso/logout.html", autologinuri="/obrar.cgi")
```

Here, `loginuri=/${app.context}/adfAuthentication`; `logouturi` is the URI of the logout script `/logout.html`. The `logouturl` could either begin with "logout" (exceptions are `logout.gif` and `logout.jpg`) or it could be any other value configured by the Administrator.

3. **Required:** The ADF application must pass the `end_url` parameter indicating where to redirect the user after logout, as follows:

If the `end_url` parameter does not include `host:port`, the `logout.html` script gets the `host:port` of the local server and constructs the `end_url` parameter as a URL. For example:

```
http://serverhost:port/oam/server/logout?end_url=http://serverhost:port/welcome.html
```

4. **11g Webgate:** Perform steps in "[Configuring Centralized Logout for 11g WebGates](#)".
5. **10g Webgate:** Perform steps in "[Configuring Centralized Logout for 10g WebGate with 11g OAM Servers](#)".

---

**See Also:**

"[Scenario: Identity Propagation with the Access Manager Token](#)" for details about setting up providers for Access Manager Identity Assertion.

---

## A.4 Confirming Application-Driven Authentication During Runtime

The application that triggers authentication and redirects the user to be authenticated by the appropriate solution. For instance, when the application determines that a user is accessing a part of a secured artifact that requires authentication application-driven authentication is triggered, in this case using Access Manager SSO.

To confirm application-driven authentication during run time

1. Create the application based on the Oracle ADF framework.
2. Configure the Access Manager SSO Security provider, as described in "[Integrating Access Manager With Web Applications Using Oracle ADF Security and the OPSS SSO Framework](#)".
3. Access the protected field and confirm that the application triggers authentication.



---

# Internationalization and Multibyte Data Support for 10g WebGates

The information here might be of interest if you are using 10g WebGates:

- [Internationalization and Multibyte Data Support on Oracle Access Manager](#)

## B.1 Internationalization and Multibyte Data Support on Oracle Access Manager

Access Manager provides multi-lingual applications and software products that can be accessed and run anywhere simultaneously, without modification, while rendering content in the native user's language and locale preferences.

A locale is the linguistic and cultural environment in which a system or program is running; data associated with a locale provides support for formatting and parsing of dates, times, numbers, currencies, and the like based on the linguistic and cultural requirements that corresponds to a given language and country.

Oracle product globalization is a two part process that includes internationalization and localization. *Internationalization* (sometimes shortened to "I18N", meaning "I - eighteen letters -N") requires that software products and applications must be usable on a computer running any supported operating system (in any supported language), with non-US keyboards or other country-specific hardware. Oracle applications do not have hard-coded dependencies on language strings, and inter-operate with non-US versions of other products. Oracle applications can handle multibyte characters and differences in a distributed environment, and also being able to detect the user's desired locale. Access Manager meets these requirements and conforms to Unicode Standard 4.0.

*Localization* includes translation of separated file text. In Oracle products, information is presented in a manner that is consistent with the user's local cultural conventions, including data formatting, collation, currency, date, time, and directionality of text (right-to-left or left-to-right), as discussed next.

For more information, see:

- [Languages For Localized Messages](#)
- [Bi-directional Language Support](#)
- [UTF-8 Encoding](#)

### B.1.1 Languages For Localized Messages

Translatable information can be categorized into two types: end-user information (accessible to all users) and administrative information (for users with Administrator privileges). When you install Oracle Access Manager 10.1.4 without a Language Pack,

English is the default language for Administrators and end users. When you install 10.1.4 with Oracle-provided Language Packs, you can choose the language to be used as the default for Administrative activities. Regardless of the default Administrator language you choose during installation, English is always installed.

---



---

**Note:**

Messages added for minor releases (10g (10.1.4.2.0) and 10g (10.1.4.3) as a result of new functionality might not be translated and can appear in only English.

---



---

For end-users, the display of static application data is provided in the End Users languages identified in [Table B-1](#): error messages, and display names for tabs, panels, and properties. Administrative information can be displayed in only the Administrators languages listed in [Table B-1](#). If administrative pages are requested in any other language (by the browser setting), the language that was selected as the default during product installation is used to display the pages.

**Table B-1 Languages for Localized Messages**

Language Tag for Installation Directory	End User Information	Administrators
en-us	English	English
ar-ar	Arabic	
pt-br	Brazilian Portuguese	Brazilian Portuguese
fr-ca	Canadian French	
cs-cs	Czech	
da-dk	Danish	
nl-nl	Dutch	
fi-fi	Finnish	
fr-fr	French	French
de-de	German	German
el-gr	Greek	
he-il	Hebrew	
hu-hu	Hungarian	
it-it	Italian	Italian
ja-jp	Japanese	Japanese
ko-kr	Korean	Korean
es-mx	Latin American Spanish	
no-no	Norwegian	



**Table B-1 (Cont.) Languages for Localized Messages**

Language Tag for Installation Directory	End User Information	Administrators
pl-pl	Polish	
pt-pt	Portuguese	
ro-ro	Romanian	
ru-ru	Russian	
zh-cn	Simplified Chinese	Simplified Chinese
sk-sk	Slovak	
es-es	Spanish/Spain	Spanish
sv-sv	Swedish	
th-th	Thai	
zh-tw	Traditional Chinese	Traditional Chinese
tr-tr	Turkish	

## B.1.2 Bi-directional Language Support

Most Western languages are written left to right (LTR), from the top of the page to the bottom. East Asian languages are usually written top to bottom, from the right side of the page to the left (RTL)—although exceptions are frequently made for technical books translated from Western languages.

Some languages, such as Hebrew and Arabic, are written and read predominantly from right to left. Numbers reverse direction in Arabic and Hebrew. While the text is written right to left, numbers within the sentence are written left to right with the most significant digit on the left, as in European and other LTR languages.

When LTR languages are mixed in with RTL languages, the complete document or content is considered *bi-directional*. Access Manager can support bi-directional languages. If the browser on the host computer is configured to use any bi-directional language, then Access Manager handles it properly.

---



---

**Note:**

No administrative languages require bi-directional support.

---



---

To provide support for multiple languages and bi-directional languages, Access Manager 10.1.4 supports the Unicode standard for encoding.

---

---

**Note:**

Writing direction does not affect the encoding of a character. Regardless of the writing direction, Oracle stores data in logical order—the order used by someone typing a language—rather than the order in which it is presented on the screen.

---

---

### **B.1.3 UTF-8 Encoding**

UTF-8 encoding and support is provided automatically, whether you have a new 10.1.4 installation or upgrade an older installation to Access Manager. You do not need to make any changes to your environment. As with previous releases, data in the directory server is stored with UTF-8 encoding.

---

---

**Note:**

All of your directory data is UTF-8 format. Access Manager does not support a mix of data types in the directory.

---

---

---

## Securing Communication

Ensure that the OAM Servers and clients (OAM Agents) can communicate securely across the Access Protocol channel.

You need to perform the following tasks to secure communication:

- [Prerequisites to Setting up a Secure Communication between OAM Servers and Webgates](#)
- [Securing Communication Between OAM Servers and WebGates](#)
- [Generating Client Keystores for OAM Tester in Cert Mode](#)
- [Configuring Cert Mode Communication for Access Manager](#)
- [Configuring Simple Mode Communication with Access Manager](#)

### C.1 Prerequisites to Setting up a Secure Communication between OAM Servers and Webgates

If OAM Server mode is Cert mode, agents must use Cert mode. During agent registration, at least one OAM Server instance must be running in the same mode as the agent. After agent registration, you can change the mode of the OAM Server.

---

**See Also:**

- [About Communication Between OAM Servers and WebGates.](#)
- For details about the SSL automation tool, managing ports for WebLogic Server, Oracle HTTP Server, and Oracle Fusion Middleware.

See *Administering Oracle Fusion Middleware*

---

### C.2 Securing Communication Between OAM Servers and WebGates

Securing communication between OAM Servers and clients (WebGates) means defining the transport security mode for the NAP (also known as the OAP) channel within the component registration page. The security level for the channel is specified as either:

- Open: Un-encrypted communication

In Open mode, there is no authentication or encryption between the WebGate and OAM Server. The WebGate does not ask for proof of the OAM Server's identity and the OAM Server accepts connections from all WebGates. Use *Open* mode if communication security is not an issue in your deployment.

- **Simple:** Encrypted communication through the Secure Sockets Layer (SSL) protocol with a public key certificate issued by Oracle.  
Use Simple mode if you have some security concerns, such as not wanting to transmit passwords as plain text, but you do not manage your own Certificate Authority (CA). In this case, OAM Servers and WebGates use the same certificates, issued and signed by Oracle CA.  
See [About Simple Mode, Encryption, and Keys](#).
- **Cert:** Encrypted communication through SSL with a public key certificate issued by a trusted third-party certificate authority (CA).  
Use Cert mode if you want different certificates on OAM Servers and WebGates and you have access to a trusted third-party CA. In this mode, you must encrypt the private key using the DES algorithm. Access Manager components use X.509 digital certificates in PEM format only. PEM refers to Privacy Enhanced Mail, which requires a passphrase. The PEM (Privacy Enhanced Mail) format is preferred for private keys, digital certificates, and trusted certificate authorities (CAs). The preferred keystore format is the JKS (Java KeyStore) format.  
See [About Cert Mode Encryption and Files](#).

---

---

**See Also:**

[About Certificates, Authorities, and Encryption Keys](#)

---

---

Logically the request is to the Access Manager credential collector. However, when you have a Web server proxy in front of the WebLogic AdminServer, with a `<LocationMatch "/*">`, all requests are routed through the proxy. In this case, there is perimeter defense using the proxy.

[Figure C-1](#) illustrates the communication channels used by OAM Servers and WebGates during user authentication and authorization.

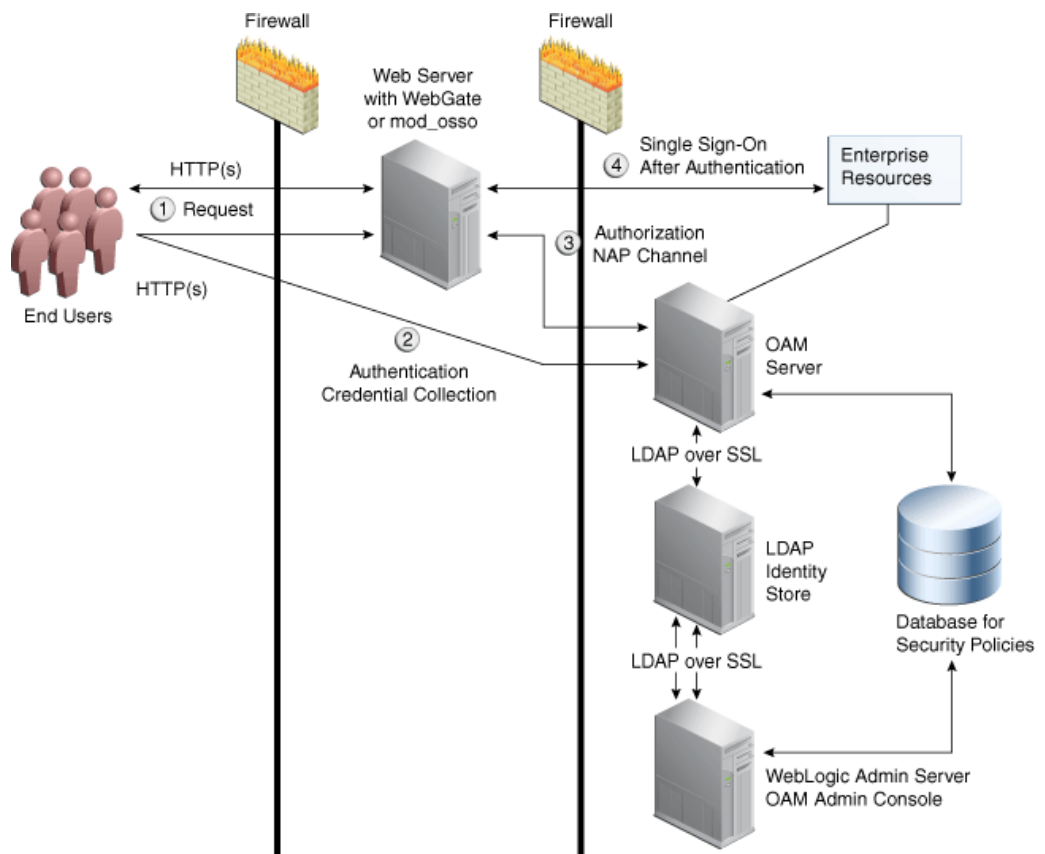
**Figure C-1 Communication Channels for OAM Servers and WebGates**

Process overview: Authentication and authorization

1. Request is intercepted by WebGate.
2. Authentication (credential collection) occurs over HTTP(s) channel.
3. Authorization occurs over the NAP channel with OAM Agents only (not mod\_osso).

Using the secure-sockets layer (SSL) protocol helps prevent eavesdropping and successful man-in-the-middle attacks across the HTTP (HTTPS) channel. The SSL protocol is included as part of most Web server products and Web browsers. SSL uses the public-and-private key encryption system, which includes the use of a digital certificate. For details about enabling SSL communication for a Web server or directory server, see your vendor's documentation.

The PEM (Privacy Enhanced Mail) format (BASE64-encoded ASCII) is preferred for private keys, digital certificates, and trusted certificate authorities (CAs). The preferred keystore format for OAM Servers is JCEKS and for OAM Clients is JKS (Java KeyStore) format. Access Manager components use X.509 digital certificates in DER (binary form of a certificate) format only.

See:

- [About Certificates, Authorities, and Encryption Keys](#)
- [About Security Modes and X509Scheme Authentication](#)
- [The Importcert Tool](#)

## C.2.1 About Certificates, Authorities, and Encryption Keys

Digital certificates can be stored in a registry from which authenticating users can look up the public keys of other users.

Depending on the public key infrastructure, the digital certificate establishes credentials for Web-based transactions based on:

- Certificate owner's name
- Certificate serial number
- Certificate expiration date
- A copy of the certificate holder's public key, which is used to encrypt messages and digital signatures
- The digital signature of the certificate-issuing authority is provided so that a recipient can verify that the certificate is real

In cryptography, a public key is a value provided by a designated authority to be used as an encryption key. The system for using public keys is called a public key infrastructure (PKI). As part of a public key infrastructure, a certificate authority checks with a registration authority (RA) to verify information provided by the requestor of a digital certificate. When the RA verifies the requestor's information, the CA can issue a certificate.

Private keys can be derived from a public key. Combining public and private keys is known as asymmetric cryptography, which can be used to effectively encrypt messages and digital signatures.

---

---

**See Also:**

- [About Cert Mode Encryption and Files](#)
  - [About Simple Mode, Encryption, and Keys](#)
- 
- 

## C.2.2 About Security Modes and X509Scheme Authentication

Administrators must ensure that the OAM Server is reachable only over the transport specified in the OAM Server configuration. OAM Server configuration defines the end points for the Server and accounts for the deployment of load balancers or reverse proxies. When the OAM Server is reachable over both HTTP and HTTPS, all requests (over either transport) are accepted. To allow the user to interact with the OAM Server (and logout) over SSL with non-X509 authentication schemes, the specified Server Port must not be configured to require CLIENT CERTS.

With the X509 authentication scheme (X509Scheme), the OAM Server SSL Port must differ from the Server Port, and must be configured to require Client Certificates. When X509Scheme is used, the X509 module is called after credential collection. X509Scheme requires the X509 challenge method and the X509 authentication module. The fully-qualified URL to the credential collector must be specified as the Challenge URL within X509Scheme. For example: `https://  
managed_server_host:managed_server_ssl_port/oam/  
CredCollectServlet/X509`

**Note:**

If a relative Challenge URL is specified with X509Scheme, the OAM Server uses the specified Server *Host/Port* to construct the fully-qualified URL of the X509 Credential Collector. However, this configuration will not work.

**See Also:**

["Managing SSO Tokens and IP Validation"](#)

## C.2.3 The Importcert Tool

Administrators use the Oracle-provided `importcert` tool for several different procedures related to keystores, keys, and certificates.

[Table C-1](#) provides the syntax for `importcert` commands.

**Table C-1** *importcert* Command Syntax

Option	Description
keystore	Follow this command with the path to an existing (or new) keystore. For example:  /scratch/.oamkeystore or /scratch/clientKey.jks
privatekeyfile	Follow this option with the path to your private key. For example:  /scratch/aaa_key.der
signedcertfile	Follow this option with the path to your signed certificate. For example:  /scratch/aaa_cert.der
alias	Follow this option with your keystore entry alias. Required with <code>genkeystore</code> .:  alias
storetype	Follow this option with your keystore type. By default, the store type is JCEKS (OAM Server keystore). For example: Server keystore .oamkeystore, of type:  JCEKS  Client keystore /scratch/clientTrustStore.jks and /scratch/clientKey.jks can be used. Both are type:  JKS

**Table C-1 (Cont.) importcert Command Syntax**

Option	Description
genkeystore	<p>This flag is required for generating OAM client certificates. The client does not expose the alias and alias password parameters. However, importcert tool sets the keystore password as the alias password.</p> <p>Specify:</p> <p>Yes or No</p> <p>Yes imports the certificates in a new keystore. No imports certificates into an existing keystore.</p>
Sample for OAM Server	<pre>- java -cp importcert.jar oracle.security.am.common.tools.importcerts.CertificateI mport -keystore &lt;path to .oamkeystore&gt; -privatekeyfile &lt;path to aaa_key.der&gt; -signedcertfile &lt;path to aaa_cert.der&gt; -alias oam.certmode -aliaspassword &lt;password&gt; -storetype &lt;JCEKS&gt; genkeystore &lt;yes&gt;</pre> <p>Enter the keystore password and alias password when prompted.</p>
Sample for OAM Client See Also <a href="#">Generating Client Keystores for OAM Tester in Cert Mode</a>	<pre>- java -cp importcert.jar oracle.security.am.common.tools.importcerts.CertificateI mport -keystore &lt;path to clientkey.JKS&gt; -privatekeyfile &lt;path to aaa_key.der&gt; -signedcertfile &lt;path to aaa_cert.der&gt; -storetype &lt;JKS&gt; genkeystore &lt;yes&gt;</pre> <p>Enter the keystore password when prompted.</p>

### C.3 Generating Client Keystores for OAM Tester in Cert Mode

Generate JKS keystores to be used with OAM Tester that is in Cert mode only, else skip this topic.

This section describes how to use importcert commands to generate client keystores for OAM Tester in Cert mode to contain the imported trusted certificate chain.

---



---

**See Also:**

[The Importcert Tool](#)

---



---

To generate client keystores for OAM Tester in Cert mode

1. Use ImportCert tool to create JKS keystores (file name specified by -privatekeyfile and -signedcertfile). For example:

```
- java -cp importcert.jar
oracle.security.am.common.tools.importcerts.CertificateImport -keystore <Keystore
path> -privatekeyfile <Private key file> -signedcertfile <Signed certificate
file> path -storetype <JKS> genkeystore <yes>
```

Enter the keystore password when prompted.



2. Proceed as needed for your environment:
  - [Configuring Cert Mode Communication for Access Manager](#)
  - [Configuring Simple Mode Communication with Access Manager](#)
3. **Remove a Keystore:** Use the following command to remove the JKS keystore. For example:

```
keytool -delete -alias <alias> -keystore <path to clientkey.JKS> -storetype
<JKS>
```

Enter the keystore password when prompted.

## C.4 Configuring Cert Mode Communication for Access Manager

Configure Cert mode communication for Access Manager with at least one OAM Server instance running in the same mode as the agent.

This topic describes how to configure Cert mode communication for Access Manager. The following tasks apply to Cert mode only.

---



---

### Note:

In Simple mode, the bundled Access Manager-CA-signed certificates are used and most of the following tasks are not needed.

---



---

### Prerequisites

During agent registration, at least one OAM Server instance must be running in the same mode as the agent. Otherwise, registration fails. After agent registration, however, you could change the communication mode of the OAM Server.

Task overview: Adding certificates for the OAM Server includes

1. Reviewing:
  - [Securing Communication Between OAM Servers and WebGates](#)
  - [About Cert Mode Encryption and Files](#)
2. [Generating a Certificate Request and Private Key for OAM Server](#)
3. [Retrieving the OAM Keystore Alias and Password](#)
4. [Importing the Trusted, Signed Certificate Chain Into the Keystore](#)
5. [Adding Certificate Details to Access Manager Settings](#)
6. [Generating a Private Key and Certificate Request for WebGates](#)
7. [Updating WebGate to Use Certificates](#)

### C.4.1 About Cert Mode Encryption and Files

The certificate request for WebGate generates the request file `aaa_req.pem`, which you must send to a root CA that is trusted by the OAM Server. The root CA returns the certificates, which can then be installed either during or after 10g WebGate installation

(for 11g WebGate these must be copied to the WebGate instance area manually after WebGate installation and configuration).

- `aaa_key.pem` (reserved name for WebGate key file, which cannot be changed)
- `aaa_cert.pem` (reserved name for WebGate certificate file, which cannot be changed)
- `aaa_chain.pem` (reserved name for CA Cert for WebGate side)

During component installation in Cert mode, you are asked to present a certificate obtained from an external CA. If you do not yet have a certificate you can request one. Until you receive the certificate, you can configure the WebGate in Simple mode. However, you cannot complete OAM deployment until the certificates are issued and installed.

If you choose Cert mode when registering WebGate as an OAM Agent, a field appears where you can enter the Agent Key Password. When editing an 11g WebGate registration, `password.xml` is updated only when the mode is changed from Open to Cert or Simple to Cert. In cert mode, once generated, `password.xml` cannot be updated. Editing the agent Key Password does not result in creation of a new `password.xml`.

You must create a Cert request and send that to the CA. When the certificate is returned you must import it to the OAM Server (or copy it to the WebGate).

## C.4.2 Generating a Certificate Request and Private Key for OAM Server

Use the following procedure to retrieve the private key, certificate, and CA certificate for the OAM Server.

---

---

**Note:**

The certified tool is openssl. Oracle recommends that you use openssl rather than other tools to generate certificates and keys in PEM format.

---

---

To retrieve the private key and certificates for OAM Server

1. Generate both the certificate request (`aaa_req.pem`) and Private Key (`aaa_key.pem`) as follows:

```
-OpenSSL req -new -keyout aaa_key.pem -out aaa_req.pem -utf8
-nodes -config openssl_silent_ohs11g.cnf
```

2. Submit the certificate request (`aaa_req.pem`) to a trusted CA.
3. Download the CA Certificate in base64 as `aaa_chain.pem`.
4. Download the Certificate in both base64 and DER format as `aaa_cert.pem` and `aaa_cert.der`.
5. Encrypt the private key (`aaa_key.pem`) using a password as follows:

```
openssl rsa -in aaa_key.pem -passin pass: -out aaa_key.pem -passout pass:
***** -des
```

**Tip:**

The common name for generating a certificate request for OAM server could be the host name of the OAM cluster's load balancer (global load balancer in case of MDC configuration) for clustered environments and the name of the host where OAM server is deployed for the non-clustered environments.

### C.4.3 Retrieving the OAM Keystore Alias and Password

Users with valid Administrator credentials can perform the following task to retrieve the alias of the certificate in the specified keystore to be used for authentication, and the password that is required to import a certificate.

To retrieve the OAM Keystore password:

1. Confirm the Oracle Access Management Console is running.
2. On the computer hosting the Oracle Access Management Console, locate the WebLogic Scripting Tool in the OAM Installation path to use when retrieving the keystore password. For example:

```
$ORACLE_IDM_HOME/common/bin/
```

Here, \$ORACLE\_IDM\_HOME is the base installation directory; /common/bin is the path in which the scripting tool is located.

3. Start the WebLogic Scripting Tool:

```
./ wlst.sh
```

4. In the WLST shell, enter the command to connect and then enter the requested information. For example:

```
wls:/offline> connect()
Please enter your username [weblogic] :
Please enter your password [welcome1] :
Please enter your server URL [t3://localhost:7001] :
wls:/base_domain/serverConfig>
```

5. Enter the following command to change the location to the read-only domainRuntime tree (For help, use help(domainRuntime)). For example:

```
wls:/OAM_AC> domainRuntime()
```

6. Use the Oracle Enterprise Manager Console to retrieve the credentials for the OAM keystore.
  - a. Login to the Oracle Enterprise Manager Console.
  - b. Navigate to Farm\_base\_domain -> WebLogic Domain -> <domain name>
  - c. Right click and select 'System mbean browser'.
  - d. Search for JpsCredentialStore.

Alternatively, navigate to application defined mbeans -> com.oracle.jps -> Domain: <domain name> -> JpsCredentialStore -> JpsCredentialStore
  - e. Click the 'operations' tab in the right hand window.
  - f. Click getPortableCredential.
  - g. Enter OAM\_STORE for or Parameter 1 and jks for or Parameter 2.

- h. Click Invoke.

The returned value is the keystore password.

7. Pay close attention to the password of the OAM Keystore that is displayed because this is required to import the certificates.
8. Proceed to the following topic:  
See [Importing the Trusted, Signed Certificate Chain Into the Keystore](#).

#### C.4.4 Importing the Trusted, Signed Certificate Chain Into the Keystore

The Oracle-provided `importcert` tool is used to import existing private key, signed certificate (public key) files into the specified keystore format: JKS (client keystore format) or JCEKS (OAM Server keystore format; `.oamkeystore` for instance.).

The keystores associated with Access Manager accepts only PKCS8 DER format certificates:

- If you have PEM format certificates signed by your certificate authority (CA), the following procedure describes how to convert and then import these using the `importcert` shipped with Access Manager.
- If PEM format certificates are not available, create a certificate request and have it signed by your CA before beginning the following procedure.

Following are the steps for using the JDK version 8 `keytool`. If you have a different version of `keytool`, refer the documentation for your JDK version.

---



---

##### Note:

When you use the `keytool` utility, the default key pair generation algorithm is Digital Signature Algorithm (DSA). However, Oracle Access Management and WebLogic Server do not support DSA and you must specify another key pair generation and signature algorithm.

---



---

##### Prerequisites

##### [Retrieving the OAM Keystore Alias and Password](#)

To import the trusted certificate chain into the keystore:

1. For setting up OAM Server in CERT mode, before making any changes to `.oamkeystore`, download the artifacts using offline WLST command:

```
downloadAccessArtifacts(domainHome="/new/path/base_domain", propsFile="/path/dbschema.properties")
```

```
---- contents of dbschema.properties ----
oam.entityStore.schemaUser=MYPREFIX_OAM
oam.entityStore.schemaPassword=Secret
oam.entityStore.ConnectString=jdbc:oracle:thin:@dbhost.us.oracle.com:1521/
servicename.us.oracle.com
```

---



---

**Note:** At every restart of Admin servers, changes are pulled in from DB. Hence we need to `downloadAccessArtifacts` and `saveAccessArtifacts`, to save the cert mode changes.

---



---

2. Locate the keytool in the following path:

```
$MW_HOME/jdk8/bin/keytool
```

3. Unzip importcert.zip and locate the Readme file in the following location:

```
$ORACLE_IDM_HOME/oam/server/tools/importcert/README
```

4. **aaa\_chain.pem:** Using a text editor, modify the aaa\_chain.pem file to remove all data except that which is contained within the CERTIFICATE blocks, then save the file.

```
----BEGIN CERTIFICATE-----
...
CERTIFICATE
...
-----END CERTIFICATE-----
```

5. Import the trusted certificate chain using the following command with details for your environment. For example:

```
keytool -importcert -file aaa_chain.pem -trustcacerts -storepass <password>
-keystore $ORACLE_HOME\user_projects\domains\<DOMAIN>\config\fmwconfig\
.oamkeystore -storetype JCEKS
```

6. When prompted to trust this certificate, type **yes**.

7. **aaa\_cert.pem:**

- a. Edit aaa\_certn.pem using TextPad to remove all data except that which is contained within the CERTIFICATE blocks, and save the file in a new location to retain the original. For example:

```
----BEGIN CERTIFICATE-----
...
CERTIFICATE
...
-----END CERTIFICATE-----
```

- b. Enter the following command to convert the signed certificate (aaa\_cert.pem) to DER format using openssl or any other tool. For example:

```
openssl x509 -in aaa_cert.pem -inform PEM -out aaa_cert.der -outform DER
```

8. **aaa\_key.pem:**

- a. Edit aaa\_key.pem to remove all data except that which is contained within the CERTIFICATE blocks, and save the file in a new location to retain the original. For example:

```
----BEGIN CERTIFICATE-----
...
CERTIFICATE
...
-----END CERTIFICATE-----
```

- b. Enter the following command to convert the private key (aaa\_key.pem) to DER format using openssl or any other tool. For example:

```
openssl pkcs8 -topk8 -nocrypt -in aaa_key.pem -inform PEM -out aaa_key.der
-outform DER
```

9. Import signed DER format certificates into the keystore. For example:

- a. Import `aaa_key.der` using the following command line arguments and details for your environment. For example:

```
c:\Middleware\idm_home\oam\server\tools\importcert
- java -cp importcert.jar
oracle.security.am.common.tools.importcerts.CertificateImport
-keystore <> -privatekeyfile <path> -signedcertfile <path>
-alias [-storetype <> genkeystore <> -help]
```

---

---

**Note:**

Enter the key store password and alias password when prompted. On a Windows system, use a semicolon (;) instead of a colon (:) in the command line.

---

---

10. After making changes, please upload the changes to db using the following offline WLST command: `saveAccessArtifacts(domainHome="/mwhome/user_projects/domains/base_domain", propsFile="/path/dbschema.properties")`.
11. Proceed to [Adding Certificate Details to Access Manager Settings](#).

## C.4.5 Adding Certificate Details to Access Manager Settings

After importing the certificates into the keystore, add the alias and password that you specified earlier into Access Manager settings configuration in Oracle Access Management Console.

---

---

**Note:**

No explicit configuration is needed for Simple mode, which is provided out of the box.

---

---

**See Also:**

- [Importing the Trusted, Signed Certificate Chain Into the Keystore](#)
  - [Managing the Access Protocol for OAM Proxy Simple and Cert Mode Security](#)
- 
- 

To add certificate details to Access Manager Settings

1. In the Oracle Access Management Console, click **Configuration** at the top of the window.
2. In the **Launch Pad** tab, select **Access Manager** from the **View** drop-down menu in the **Settings** section.
3. In the **Access Protocol** section, fill in the alias and alias password details acquired in the previous procedure. For example:

**Cert Mode Configuration**

**PEM keystore Alias:** `my_keystore_alias`

**PEM keystore Alias Password:** `my_keystore_alias_pw`

4. Click **Apply** to save the configuration.
5. Close the page.
6. Open the OAM Server registration page, click the **Proxy** tab, change the **Proxy mode** to **Cert**, and click **Apply**.
7. Restart the OAM Server.
8. Proceed to the following topic:

See [Generating a Private Key and Certificate Request for WebGates](#).

## C.4.6 Generating a Private Key and Certificate Request for WebGates

Retrieve the private key, certificate, and CA certificate for the WebGate using openssl.

The certified tool is openssl. Oracle recommends that you use openssl rather than other tools to generate certificates and keys in PEM format.

To retrieve the private key and certificates for WebGates

1. Generate both the certificate request (aaa\_req.pem) and Private Key (aaa\_key.pem) as follows:

```
openssl req -new -keyout aaa_key.pem -out aaa_req.pem -utf8 -nodes -sha256
```

2. Submit the certificate request (aaa\_req.pem) to a trusted CA.
3. Download the CA Certificate in base64 as aaa\_chain.pem.
4. Download the Certificate in base64 format as aaa\_cert.pem.
5. Encrypt the private key (aaa\_key.pem) using a password as follows:

```
openssl rsa -in aaa_key.pem -passin pass: -out aaa_key.pem -passout pass:
***** -des -sha256
```

**Tip:**

The common name for generating a certificate request for WebGates could be the host name of the Web Server where the agent is deployed.

6. Proceed to [Updating WebGate to Use Certificates](#).

## C.4.7 Updating WebGate to Use Certificates

For all communication modes (Open, Simple, or Cert), the Agent registration should be updated from the Oracle Access Management Console:

- Registering an Agent: If you choose Cert mode when registering an OAM Agent, a field appears where you can enter the Agent Key Password.
- Editing/Updating an Agent: When editing an 11g WebGate registration, password.xml is updated only when the mode is changed from Open to Cert or Simple to Cert.

Editing the agent Key Password does not result in creation of a new password.xml. In Cert mode, once generated, password.xml cannot be updated.

Prerequisites

## Adding Certificate Details to Access Manager Settings

To update the communication mode in the WebGate Agent registration

1. In the Oracle Access Management Console, click **Application Security** at the top of the window.
2. In the **Launch Pad** tab, click **Agents**.
3. On the Search page, define your criteria and open the desired agent registration, as described in "[WebGate Search Controls](#)".
4. On the agent's registration page, locate the **Security** options and click **Cert** (or **Simple**).
5. **Cert Mode:** Enter the **Agent key Password** as specified in Step 5 of "[Generating a Private Key and Certificate Request for WebGates](#)".
6. Click **Apply** to submit the changes.
7. Copy your updated WebGate files as follows:

### 11g WebGate:

```
ObAccessClient.xml
cwallet.sso (11g WebGate only)
password.xml
```

- **From:** \$IDM\_DOMAIN\_HOME/output/AGENT\_NAME
- **To:** \$OHS\_INSTANCE\_HOME/config/OHS/ohs2/webgate/config

### 10g WebGate: ObAccessClient.xml

- **From:** \$WLS\_DOMAIN\_HOME/output/AGENT\_NAME
- **To:** \$WebGate\_install\_dir/oblix/lib

### 10g WebGate: password.xml

- **From:** \$WLS\_DOMAIN\_HOME/output/AGENT\_NAME
- **To:** \$WebGate\_install\_dir/oblix/config

8. Copy the following files that were created when "[Generating a Certificate Request and Private Key for OAM Server](#)":

### 11g WebGate:

- **From:**
  - aaa\_key.pem: *WebGate11g\_home/webgate/ohs/tools/openssl*
  - aaa\_cert.pem: The location where this was saved after receiving from CA
  - aaa\_chain.pem: The location where this was saved after receiving from CA

- **To:** OHS\_INSTANCE\_HOME/config/OHS/ohs2/webgate/config

### 10g WebGate:



- From:
  - aaa\_key.pem: The location where the private key file was generated
  - aaa\_cert.pem: The location where this was saved after receiving from CA
  - aaa\_chain.pem: The location where this was saved after receiving from CA
- To: `$WebGate_install_dir/oblix/config`

9. Restart the OAM Server and the Oracle HTTP Server instance.

## C.5 Configuring Simple Mode Communication with Access Manager

The transport security communication mode is chosen during OAM installation. In Simple mode, the installer generates a random global passphrase initially, which can be edited as required later.

---



---

### Note:

Communication between the agent and server works when the WebGate mode matches (or is higher) than the OAM Server mode.

---



---

When you register an OAM Agent or a new OAM Server, you can specify the Security mode. However, changing the global passphrase requires that you reconfigure all agents to use the mode and the new global passphrase.

---



---

### Note:

During agent registration, at least one OAM Server instance must be running in the same mode as the agent. Otherwise, registration fails. After agent registration, however, you could change the communication mode of the OAM Server.

---



---

The highest level of security is Cert mode, the lowest is Open mode. The agent mode can be higher but not lower. For example, Open mode can be updated to SIMPLE or CERT.

This section provides the information you need to configure Simple mode communication.

### Task overview: Configuring Simple mode communication includes

1. Reviewing:
  - [About Simple Mode, Encryption, and Keys](#)
  - [The Importcert Tool](#)
2. [Retrieving the Global Passphrase for Simple Mode](#)
3. [Updating WebGate Registration for Simple Mode](#)
4. [Verifying SIMPLE Mode Configuration](#)

## C.5.1 About Simple Mode, Encryption, and Keys

For Simple mode encryption, Access Manager includes a certificate authority with its own private key, which is installed across all WebGates and OAM Servers.

During installation, the OAM Server generates and saves the private-public keypair for the server. Similarly, for the OAM agent, an Oracle certificate authority is installed with the agent installation.

The installer generates a random global passphrase initially, which can be edited or viewed as needed. When an agent is registered in SIMPLE mode, the following client certificates are generated to be consumed by clients:

- `aaa_key.pem`: Contains private key
- `aaa_cert.pem`: Signed certificate
- `password.xml`: Contains the random global passphrase in obfuscated format

---

---

**Note:**

Changing the global passphrase requires reconfiguring all agents that are already configured in Simple mode.

---

---

## C.5.2 Retrieving the Global Passphrase for Simple Mode

Retrieve the random global passphrase generated by Access Manager for Simple mode communication during installation.

To retrieve the random global passphrase for Simple mode communication

1. Ensure that the Oracle Access Management Console is running.
2. On the computer hosting the Oracle Access Management Console, locate the WebLogic Scripting Tool in the following path. For example:

```
$ORACLE_IDM_HOME/common/bin
```

Where `$ORACLE_IDM_HOME` represents the base installation directory path; `common/bin` is the path wherein the scripting tool is located.

3. Start the WebLogic scripting tool. For example, on a Unix system:

```
./ wlst.sh
```

4. In the WLST shell, enter the command to connect and then enter the requested information. For example:

```
wls:/offline> connect()
Please enter your username [weblogic] :
Please enter your password [weblogic] :
Please enter your server URL [t3://localhost:7001] :
wls:/base_domain/serverConfig>
```

5. Enter the following command to change the location to the read-only domainRuntime tree (for help, use `help(domainRuntime)`). For example:

```
wls:/OAM_AC>domainRuntime()
```

6. View the global passphrase by entering the following command. For example:

```
wls:/OAM_AC> displaySimpleModeGlobalPassphrase()
```

7. Proceed to "[Updating WebGate Registration for Simple Mode](#)".

### C.5.3 Updating WebGate Registration for Simple Mode

Artifacts generated for Simple Security mode use the Global Pass phrase and any change must be propagated to WebGates.

To update an existing WebGate registration for Simple mode, you can delete the WebGate registration using the Oracle Access Management Console, then re-register it (specifying Simple mode and disabling the automatic generation of policies). Alternatively, you can edit the WebGate registration and then copy the artifacts as described here.

---

#### See Also:

- [Viewing or Editing an OAM Agent Registration Page in the Console](#)
- 

To update the WebGate registration for Simple mode

1. In the Oracle Access Management Console, click **Application Security** at the top of the window.
2. In the **Launch Pad** tab, click **Agents**.
3. On the Search page, define your criteria and open the desired agent registration, as described in "[WebGate Search Controls](#)".
4. In the registration page, locate the Security options and click **Simple**.
5. Click **Apply** to submit the changes.
6. Copy the updated WebGate files as follows:

#### 11g WebGate:

```
ObAccessClient.xml
cwallet.sso (11g WebGate only)
password.xml
```

- **From:** \$WLS\_DOMAIN\_HOME/output/AGENT\_NAME (the WebLogic domain home where the OAM AdminServer is installed)
- **To:** \$OHS\_INSTANCE\_HOME/config/OHS/ohs2/webgate/config

#### 10g WebGate: ObAccessClient.xml

- **From:** \$WLS\_DOMAIN\_HOME/output/AGENT\_NAME
- **To:** \$WebGate\_install\_dir/oblix/lib

#### 10g WebGate: password.xml

- **From:** \$WLS\_DOMAIN\_HOME/output/AGENT\_NAME
- **To:** \$WebGate\_install\_dir/oblix/config

7. Copy the following files, as directed for your WebGate release:

```
aaa_key.pem
aaa_cert.pem
```

**11g WebGate:**

- **From:** \$IDM\_DOMAIN\_HOME/output/AGENT\_NAME
- **To:** \$OHS\_INSTANCE\_HOME/config/OHS/ohs2/webgate/config/simple

**10g WebGate:**

- **From:** \$IDM\_DOMAIN\_HOME/output/AGENT\_NAME
- **To:** \$WebGate\_install\_dir/oblix/config/simple

8. Restart the OAM Server and the Oracle HTTP Server instance.

## C.5.4 Verifying SIMPLE Mode Configuration

Restart the Web server to instantiate the change to SIMPLE mode to validate the results

To validate SIMPLE mode changes:

1. From a command-line window, restart the Web server as shown in the following example:

For 11g Webgate:

```
d:\middleware\ohs_home\instances\ohs_webgate11g\bin
opmnctl stopall
opmnctl startall
```

For 12c Webgate:

```
$(Oracle_Home)/user_projects/domains/base_domain/bin/stopComponent.sh ohs1
(stopComponent.sh ohs1) $(Oracle_Home)/user_projects/domains/base_domain/bin/
startComponent.sh ohs1
```

2. In a browser window, enter the URL to a resource protected by the WebGate using Simple mode.
3. Enter your login credentials, when asked.
4. Confirm that the resource is served.

---

## Reviewing Bundled, Generated, and Migrated Artifacts

This appendix provides a look at sample artifacts that are either bundled with Access Manager, or generated during agent registration. This appendix includes the following sections:

- [Bundled 10g IAMSuiteAgent Artifacts](#)
- [Generated Artifacts: OpenSSO](#)
- [Migrated Artifacts: OpenSSO](#)

### D.1 Bundled 10g IAMSuiteAgent Artifacts

This section provides the following topics:

- [Pre-Registered 10g IAMSuiteAgent](#)
- [IAMSuiteAgent Security Provider Settings, WebLogic Administration Console](#)
- [IAMSuiteAgent Registration](#)
- [Resources Protected by IAMSuiteAgent](#)
- [Pre-seeded IAM Suite Application Domain and Policies](#)

#### D.1.1 Pre-Registered 10g IAMSuiteAgent

This 10g OAM Agent and the companion Application Domain are available with 11.1.1.5. Oracle strongly recommends that you do not alter these definitions.

See [Managing Policies to Protect Resources and Enable SSO](#).

---

**Note:**

The original IDMDomainAgent is not available with this patch set. It remains as an artifact after you apply the patch set. However, all content is removed.

---

The IAMSuiteAgent provides single sign-on functionality for the IDM Administration Console. The IAMSuiteAgent is installed and pre-configured as part of the OAM Server installation and configuration.

The IAMSuiteAgent is a domain-wide agent:

- Once deployed, the IAMSuiteAgent is installed on every server in the domain

- Unless disabled, every request coming into the WebLogic Application Server is evaluated and processed by the IAMSuiteAgent
- Configuration details are located under the 10g Webgates node (Policy Configuration tab) in the Oracle Access Management Console

Certain IAMSuiteAgent configuration elements are available in the WebLogic Administration Console (in the Security Provider section) and others in the Oracle Access Management Console.

## D.1.2 IAMSuiteAgent Security Provider Settings, WebLogic Administration Console

In the Security Provider section of the WebLogic Administration Console are five bootstrap configuration parameters.

While Oracle recommends that you retain these without making changes, there are circumstances where you might need to change one of the following parameters:

- **Primary Access Server:** You can replace this value with information for your actual OAM Server. The default value (localhost:5575) can be replaced with information for your actual OAM Server if more than one host is part of the IDM Domain. The IAM Suite Agent and companion Application Domain (IAMSuite) replaces the 11.1.1.3.0 IDM Domain Agent and its companion Application Domain.Agent Password: By default there is no password. However, you can add one here if you want to establish a password for the IAMSuiteAgent connection to the OAM Server through the NetPoint (now Oracle) Access Protocol (NAP or OAP).

Figure D-1 illustrates the default Security Provider settings for the IAMSuiteAgent.

**Figure D-1 IAMSuiteAgent Settings in the WebLogic Administration Console**

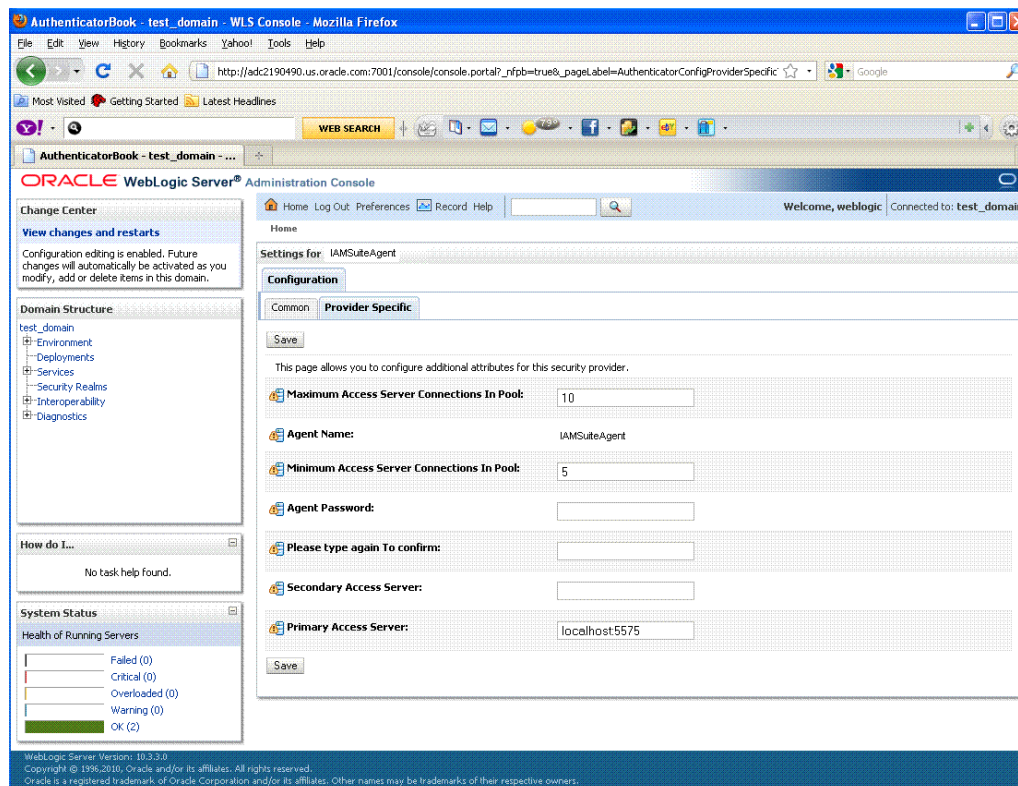

### D.1.3 IAMSuiteAgent Registration

The IAMSuiteAgent registration page provides details about the agent, like all other OAM agent registration pages.

- Security Mode: Open is the only security mode available for the IAMSuiteAgent. This cannot be changed.
- Preferred Host: IAMSuiteAgent is the pre-configured host required by this agent

**Note:**

The Access Client Password here must match the Agent Password in the WebLogic Administration Console. If you changed the Agent Password, you must also change the Access Client Password.

Figure D-2 shows the IAMSuiteAgent page. Notice the User Defined Parameter, which informs behavior to fall back to the container policy in the WebLogic Server and provides a redirect URL for logout.

**Figure D-2 IAMSuiteAgent Registration**

The screenshot shows the IAMSuiteAgent configuration page. It includes fields for Version (10g), Name (IAMSuiteAgent), Description, Access Client Password, Primary Cookie Domain (.us.oracle.com), Security (Open), State (Enable), Max Cache Elements (0), Cache Timeout (0s), Max Connections (1), Max Session Time (24s), Cookie Session Time (24s), Idle Session Timeout (3600s), Failover Threshold (1), and AAA Timeout Threshold (-1). On the right, there are fields for Preferred Host (IAMSuiteAgent), Logout URL, Deny On Not Protected, User Defined Parameters (including fallbackToContainerPolicy=true, protectWebXmlSecuredPagesOnly=true, and logoutRedirectUrl=http://slc01mqd.us.oracle.com), Sleep for (60s), Cache Pragma Header (no-cache), Cache Control Header (no-cache), Debug, IP Validation, Allow Management Operations, Sharepoint Impersonation User, and Sharepoint Impersonation Password. At the bottom, there are two server lists: Primary Server List (with one entry: oam\_server, slc01mqd.u..., 5575, 5) and Secondary Server List (empty).

You can replace this agent with a 10g Webgate, as described in [Registering and Managing 10g WebGates with Access Manager 11g](#).

Table D-1 outlines the differences between IAMSuiteAgent and 11g and 10g WebGates.

**Table D-1 Comparing IAMSuiteAgent with 11g and 10g Webgates**

Element	11g Webgate	10g Webgate	IAMSuiteAgent
Primary Cookie Domain	N/A	x	x
Token Validity Period	x	N/A	N/A
Preferred Host	x	x	x
Logout URL	x	x	x
Logout Callback URL	x	N/A	N/A
Logout Redirect URL	x	N/A	N/A
Logout Target URL	x	N/A	N/A
Cache Pragma Header	x	x	x
Cache Control Header	x	x	x
User Defined Parameters	proxySSLHeaderVar=IS_S SL URLInUTF8Format=true client_request_retry_a ttempts=1 inactiveReconfigPeriod =10	proxySSLHeaderVar=IS_S SL URLInUTF8Format=true client_request_retry_a ttempts=1 inactiveReconfigPeriod =10	fallbackToContainerPol icy=true logoutRedirectUrl=http :// hostname.domain.com: 14100/oam/server/ logout protectWebXmlSecuredPa gesOnly=true
Deny on Not Protected	x	x	x

### D.1.4 Resources Protected by IAMSuiteAgent

Figure D-3 illustrates the resources protected by the IAMSuiteAgent, including the exact Authentication and Authorization policies. Oracle recommends that you do not make any additions or changes. The WebLogic Administration Console (/console) is protected.



**Figure D-3 Resources Protected by the IAMSuiteAgent**

**IAM Suite** Application Domain

Application Domain provides a logical container for resources or sets of resources, and the associated policies that dictate who can access specific protected resources.

Summary **Resources** Authentication Policies Authorization Policies Token Issuance Policies Administration

Use the search tool to find an existing Resource or click the New Resource button to create a new one.

**Search**

Resource Type: HTTP      Query String:

Host Identifier:       Authentication Policy:

Resource URL:       Authorization Policy:

**Search Results**

Actions View Create Duplicate Edit Delete Detach

Row	Resource Type	Host Identifier	Resource URL	Query String	Authentication Policy	Authorization Policy
1	HTTP	IAMSuiteAgent	/ucs/**			
2	HTTP	IAMSuiteAgent	/reqsvc/**			
3	HTTP	IAMSuiteAgent	/sts/**			
4	HTTP	IAMSuiteAgent	/oamfed/**			
5	HTTP	IAMSuiteAgent	/oam/serverfed/authn/sc...		LocalAuthnFederationFA...	Protected Resource Policy
6	HTTP	IAMSuiteAgent	/oam/serverfed/authn/sc...		LocalAuthnFederationLD...	Protected Resource Policy
7	HTTP	IAMSuiteAgent	/oam/serverfed/authn/sc...		LocalAuthnFederationBa...	Protected Resource Policy
8	HTTP	IAMSuiteAgent	/oam/serverfed/authn/sc...		LocalAuthnFederationBa...	Protected Resource Policy
9	HTTP	IAMSuiteAgent	/oamssso-bin/**			
10	HTTP	IAMSuiteAgent	/oamssso/**			
11	HTTP	IAMSuiteAgent	/oamreauthenticate/**		ESSOAuthnPolicy	ESSOReauthAuthzpolicy
12	HTTP	IAMSuiteAgent	/logonmanager/**		ESSOAuthnPolicy	ESSOAuthzPolicy
13	HTTP	IAMSuiteAgent	/idaas/am/esso/**		ESSOAuthnPolicy	ESSOAuthzPolicy
14	HTTP	IAMSuiteAgent	/wlm/**		ESSOAuthnPolicy	ESSOAuthzPolicy
15	HTTP	IAMSuiteAgent	/oaaam_offline/**			
16	HTTP	IAMSuiteAgent	/oaaam_server/**			
17	HTTP	IAMSuiteAgent	/oam/serverfed/sp/ssol/s...		Federation SSO Protecte...	Protected Resource Policy
18	HTTP	IAMSuiteAgent	/oamTAPResponseAsse...		TAP Response Protected...	Protected Resource Policy
19	HTTP	IAMSuiteAgent	/ms_oauth/style/*			
20	HTTP	IAMSuiteAgent	/ms_oauth/img/*			
21	HTTP	IAMSuiteAgent	/ms_oauth/resources/**			
22	HTTP	IAMSuiteAgent	/ms_oauth/oauth2/oam...			
23	HTTP	IAMSuiteAgent	/ms_oauth/oauth2/endpo...			
24	HTTP	IAMSuiteAgent	/favicon.ico			
25	HTTP	IAMSuiteAgent	/.../.ico			

### D.1.5 Pre-seeded IAM Suite Application Domain and Policies

The following figures present Authentication Policies in the IAM Suite Application Domain:

- [Figure D-4](#)
- [Figure D-5](#)
- [Figure D-6](#)
- [Figure D-7](#)

**Figure D-4 IAMSuite Authentication Policy: OAM Admin Console Policy**

**OAM Admin Console Policy** Authentication Policy Duplicate Apply

Authentication Policy defines the type of verification that must be performed to provide a sufficient level of trust for Access Manager to grant access to the user making the request. A single policy can be defined to protect one or more resources in the Application Domain.

\* Name:  Success URL:

Description:  Failure URL:

\* Authentication Scheme:

Resources Responses Advanced Rules

Resources <span style="float: right;">+ Add X Delete</span>			
Resource Type	Host Identifier	Resource URL	Query String
HTTP	IAMSuiteAgent	/access/**	
HTTP	IAMSuiteAgent	/oamconsole/**	

**Figure D-5 Protected HigherLevel Policy: Authentication, LDAP Scheme**

**Protected HigherLevel Policy** Authentication Policy Duplicate Apply

Authentication Policy defines the type of verification that must be performed to provide a sufficient level of trust for Access Manager to grant access to the user making the request. A single policy can be defined to protect one or more resources in the Application Domain.

\* Name:  Success URL:

Description:  Failure URL:

\* Authentication Scheme:

Resources Responses Advanced Rules

Resources <span style="float: right;">+ Add X Delete</span>			
Resource Type	Host Identifier	Resource URL	Query String
HTTP	IAMSuiteAgent	/ms_oauth/oauth2/ui/**	
HTTP	IAMSuiteAgent	/sysadmin/	
HTTP	IAMSuiteAgent	/xmlpserver	
HTTP	IAMSuiteAgent	/sysadmin	
HTTP	IAMSuiteAgent	/identity/faces/taskdetails	
HTTP	IAMSuiteAgent	/identity/faces/trackregistration...	
HTTP	IAMSuiteAgent	/identity/faces/request	
HTTP	IAMSuiteAgent	/identity/	
HTTP	IAMSuiteAgent	/identity	
HTTP	IAMSuiteAgent	/sysadmin/faces/home	
HTTP	IAMSuiteAgent	/identity/faces/home	
HTTP	IAMSuiteAgent	/oim/faces/pages/Admin.jspx	
HTTP	IAMSuiteAgent	/oim/faces/pages/Self.jspx	
HTTP	IAMSuiteAgent	/admin/faces/pages/Admin.jspx	
HTTP	IAMSuiteAgent	/oamTAPAuthenticate	
HTTP	IAMSuiteAgent	/oam_admin/**	
HTTP	IAMSuiteAgent	/apm/**	
HTTP	IAMSuiteAgent	/oinav/**	
HTTP	IAMSuiteAgent	/em/**	
HTTP	IAMSuiteAgent	/console/**	

**Figure D-6 Protected LowerLevel Policy: Authentication, OIMScheme**

**Protected LowerLevel Policy** Authentication Policy Duplicate Apply

Authentication Policy defines the type of verification that must be performed to provide a sufficient level of trust for Access Manager to grant access to the user making the request. A single policy can be defined to protect one or more resources in the Application Domain.

\* Name: Protected LowerLevel Policy Success URL:

Description: Protected Authentication Policy for OAMAgent Failure URL:

\* Authentication Scheme: OIMScheme

Resources Responses Advanced Rules

Resource Type	Host Identifier	Resource URL	Query String
HTTP	IAMSuiteAgent	/identity/faces/firstlogin	
HTTP	IAMSuiteAgent	/admin/faces/pages/pwdmgmt...	

**Figure D-7 Public Policy: Authentication, AnonymousScheme**

**Public Policy** Authentication Policy Duplicate Apply

Authentication Policy defines the type of verification that must be performed to provide a sufficient level of trust for Access Manager to grant access to the user making the request. A single policy can be defined to protect one or more resources in the Application Domain.

\* Name: Public Policy Success URL:

Description: Protected Authentication Policy for OAMAgent Failure URL:

\* Authentication Scheme: AnonymousScheme

Resources Responses Advanced Rules

Resource Type	Host Identifier	Resource URL	Query String
HTTP	IAMSuiteAgent	/HTTPClnt/**	
HTTP	IAMSuiteAgent	/callbackResponseService/**	
HTTP	IAMSuiteAgent	/role-sod/**	
HTTP	IAMSuiteAgent	/sysadmin/**	
HTTP	IAMSuiteAgent	/oim/**	
HTTP	IAMSuiteAgent	/admin/**	
HTTP	IAMSuiteAgent	/XIMDD/**	
HTTP	IAMSuiteAgent	/spml-xsd/**	
HTTP	IAMSuiteAgent	/spmlws/**	
HTTP	IAMSuiteAgent	/sodcheck/**	
HTTP	IAMSuiteAgent	/SchedulerService-web/**	
HTTP	IAMSuiteAgent	/jmx-config-lifecycle/**	

IAM Suite Authorization Policy

Figure D-8 presents Authorization Policy in the IAM Suite Application Domain. By default, no explicit conditions or responses are defined. However, you can add any that are appropriate for your environment.

**Figure D-8 IAM Suite Authorization Policy**

**Protected Resource Policy** Authorization Policy Duplicate Apply

Authorization policy contains a set of conditions that define whether a user should be permitted or denied access to the resources protected by the policy. Authorization rules and conditions apply to all resources within a specific Authorization policy.

Summary **Resources** Conditions Rules Responses

Resources <span style="float: right;">+ Add X Delete</span>					
Resource Type	Host Identifier	Resource URL	Query String	Name Value list	Operations
HTTP	IAMSuiteAgent	/oam/serverfed/authn/scheme...			All
HTTP	IAMSuiteAgent	/oam/serverfed/authn/scheme...			All
HTTP	IAMSuiteAgent	/oam/serverfed/authn/scheme...			All
HTTP	IAMSuiteAgent	/oam/serverfed/authn/scheme...			All
HTTP	IAMSuiteAgent	/oam/serverfed/sp/sso/service			All
HTTP	IAMSuiteAgent	/oamTAPResponseAssertRes...			All
HTTP	IAMSuiteAgent	/HTTPCntl**			All
HTTP	IAMSuiteAgent	/callbackResponseService**			All
HTTP	IAMSuiteAgent	/role-sod**			All
HTTP	IAMSuiteAgent	/sysadmin**			All
HTTP	IAMSuiteAgent	/oim**			All
HTTP	IAMSuiteAgent	/admin**			All
HTTP	IAMSuiteAgent	/XIMDD/**			All
HTTP	IAMSuiteAgent	/spml-xsd/**			All
HTTP	IAMSuiteAgent	/spmlws/**			All
HTTP	IAMSuiteAgent	/sodcheck/**			All
HTTP	IAMSuiteAgent	/SchedulerService-web/**			All
HTTP	IAMSuiteAgent	/jmx-config-lifecycle/**			All
HTTP	IAMSuiteAgent	/identity/faces/firstlogin			All
HTTP	IAMSuiteAgent	/admin/faces/pages/pwdmgmt...			All
HTTP	IAMSuiteAgent	/oamDirectAuthentication			All
HTTP	IAMSuiteAgent	/oamUserPasswordAuthentica...			All
HTTP	IAMSuiteAgent	/oamImpersonationConsent			All
HTTP	IAMSuiteAgent	/ms_oauth/oauth2/ui/**			All
HTTP	IAMSuiteAgent	/sysadmin/			All

**IAM Suite Token Issuance Policy**

Figure D-9 presents IAM Suite Token Issuance Policy in the IAM Suite Application Domain. By default, there are no explicit conditions defined. However, you can define any that are needed in your environment.

**Figure D-9 IAM Suite Token Issuance Policy and Resource URLs**

**TokenIssuancePolicy1** Token Issuance Policy Duplicate Apply

Token Issuance Policy defines the rules under which a token can be issued for a resource (Relying Party Partner) based on the client's identity. The client can be either a Requester Partner or an end user.

Summary **Resources** Conditions Rules

Resources <span style="float: right;">+ Add X Delete</span>					
Resource Type	Host Identifier	Resource Pattern	Query String	Name Value list	Operations
This Policy does not protect any Resources					

**D.2 Generated Artifacts: OpenSSO**

This section shows the custom authentication module, host identifier, Application Domain, and policies generated during OpenSSO Agent provisioning.

- [Generated OpenSSOAgentAuthPlugin](#)
- [Generated Host Identifier: OpenSSOAgent1](#)
- [Generated Application Domain: OpenSSOAgent1](#)

- [Generated Resources: OpenSSOAgent1](#)
- [Generated Authentication Policy: OpenSSOAgent Application Domain](#)
- [Generated Authorization Policy: OpenSSOAgent Application Domain](#)

## D.2.1 Generated OpenSSOAgentAuthPlugin

Figure D-10 shows the OpenSSOAgent Custom Authentication Module: OpenSSOAgentAuthPlugin.

**Figure D-10** *Generated Authentication Module: OpenSSOAgentAuthPlugin*

**Authentication Module** Authentication Module Apply

Custom Authentication Module relies on bundled plug-ins (or those that are developed using the Access Manager Authentication Extensibility Java API). This module uses more than one plug-in that you can orchestrate to ensure that each one performs a specific authentication function.

General **Steps** Steps Orchestration

View + × Detach

Step Name	Description	Plug-in Name
stepAuth	OpenSSOAgentAuthPlugi...	OpenSSOAgentAuthenticationPlugin

**Step Details** Save Cancel

Step Name stepAuth

Description

Plug-in Name OpenSSOAgentAuthenticationPlugin

## D.2.2 Generated Host Identifier: OpenSSOAgent1

**Figure D-11** *Generated Host Identifier: OpenSSOAgent1*

**OpenSSOAgent1** Host Identifier Duplicate Apply

A Host Identifier must be configured for each Web site or virtual Web site that you want to protect with Access Manager. Host Identifier simplifies the identification of a Web server host by defining all possible hostname variations.

Name OpenSSOAgent1

Description Host Identifier created for agent during Remote Registration

**Host Name Variations** + ×

Host Name	Port
OpenSSOAgent1	

## D.2.3 Generated Application Domain: OpenSSOAgent1

**Figure D-12** *Generated Application Domain: OpenSSOAgent1*

**OpenSSOAgent1** Application Domain

Application Domain provides a logical container for resources or sets of resources, and the associated policies that dictate who can access specific protected resources.

Summary Resources Authentication Policies Authorization Policies Token Issuance Policies Administration

Apply

\* Name: OpenSSOAgent1

Description: Application Domain created through Remote Registration

\* Session Idle Timeout (minutes): 0

Allow OAuth Token

Allow Session Impersonation

Enable Policy Ordering

## D.2.4 Generated Resources: OpenSSOAgent1

**Figure D-13** *Application Domain Resources: OpenSSOAgent1*

**OpenSSOAgent1** Application Domain

Application Domain provides a logical container for resources or sets of resources, and the associated policies that dictate who can access specific protected resources.

Summary Resources Authentication Policies Authorization Policies Token Issuance Policies Administration

Use the search tool to find an existing Resource or click the New Resource button to create a new one.

Search

Resource Type: HTTP Query String:

Host Identifier:  Authentication Policy:

Resource URL:  Authorization Policy:

Search Reset

Search Results

Actions View Create Duplicate Edit Delete Detach

Row	Resource Type	Host Identifier	Resource URL	Query String	Authentication Policy	Authorization Policy
1	HTTP	OpenSSOAgent1	/*		Protected Resource Policy	Protected Resource Policy

## D.2.5 Generated Authentication Policy: OpenSSOAgent Application Domain

**Figure D-14** *Generated Authentication Policy: OpenSSOAgent Application Domain*

**Protected Resource Policy** Authentication Policy

Duplicate Apply

Authentication Policy defines the type of verification that must be performed to provide a sufficient level of trust for Access Manager to grant access to the user making the request. A single policy can be defined to protect one or more resources in the Application Domain.

\* Name: Protected Resource Policy Success URL:

Description: Policy set during domain creation. Add resources to this policy to protect them. Failure URL:

\* Authentication Scheme: LDAPScheme

Resources Responses Advanced Rules

Resources Add Delete

Resource Type	Host Identifier	Resource URL	Query String
HTTP	OpenSSOAgent1	/*	

## D.2.6 Generated Authorization Policy: OpenSSOAgent Application Domain

**Figure D-15** *Generated Authorization Policy: OpenSSOAgent Application Domain*

**Protected Resource Policy** Authorization Policy Duplicate Apply

Authorization policy contains a set of conditions that define whether a user should be permitted or denied access to the resources protected by the policy. Authorization rules and conditions apply to all resources within a specific Authorization policy.

Summary **Resources** Conditions Rules Responses

Resources					
Resource Type	Host Identifier	Resource URL	Query String	Name Value list	Operations
HTTP	OpenSSOAgent1	/*			All

## D.3 Migrated Artifacts: OpenSSO

This section shows the artifacts that are migrated when you use Oracle-provided tools to analyze and migrate an OpenSSO environment to Oracle Access Management Console.

- [Migrated User Identity Store: OpenSSOAgent1](#)
- [Migrated Agents: OpenSSOAgent1](#)
- [Migrated Authentication Module: OpenSSOAgent1](#)
- [Migrated Host Identifier: OpenSSOAgent1](#)
- [Migrated Application Domain: OpenSSOAgent1](#)
- [Migrated Resources: OpenSSOAgent1](#)
- [Migrated Authentication Policy: OpenSSOAgent1](#)
- [Migrated Authorization Policy: OpenSSOAgent1](#)

## D.3.1 Migrated User Identity Store: OpenSSOAgent1

**Figure D-16 Migrated User Identity Store**

**MigratedStore1** User Identity Store Service

Store Name MigratedStore1

\* Store Type AD: Microsoft Active Directory

Description

**Location and Credentials**

\* Location ldap-host:7001

\* Bind DN cn=Admin

**Users and Groups**

\* Login ID Attribute uid

User Password Attribute userPassword

\* User Search Base ou=people,ou=myrealm,dc=base\_doma

User Filter Object Classes

Group Name Attribute

\* Group Search Base ou=groups,ou=myrealm,dc=base\_dome

Group Filter Classes

Enable Group Membership Cache

Group Membership Cache Maximum Size 0

Group Membership Cache Time to Live (in seconds) 0

**Connection Details**

Minimum Pool Size 0

Maximum Pool Size 0

Wait Timeout (in seconds) 0

Inactivity Timeout (in seconds) 0

**Password Management**

Enable Password Management

Duplicate Test Connection Apply

Enable SSL

Use Native ID Store Settings

Prefetched Attributes

\* Password

Results time limit (in seconds) 0

Retry Count 0

Referral Policy



## D.3.2 Migrated Agents: OpenSSOAgent1

Figure D-17 Migrated Agent: OpenSSOAgent1

**OpenSSOAgent1** OpenSSO Agent Apply

**General**

Agent Type: J2EE  
 Agent Name: OpenSSOAgent1  
 Password:   
 Re-enter Password:   
 \* Base URL: http://www.oracle.com  
 Status: Enabled  
 Filter Mode: URL\_POLICY

\* Realm Name: OpenSSOAgent1  
 Session Timeout (In Seconds): 0  
 Max Sessions: 0  
 \* Cookie Name: iPlanetDirectoryPro  
 Cookie Separator: |  
 Enable Cookie Encoding

**URLs**

Login URLs		Logout URLs		Not Enforced URIs	
Sr. No.	Login URL	Sr. No.	Logout URL	Sr. No.	Not Enforced URI
1	http://slc01mqd.us.oracle.com:1410/	1	http://slc01mqd.us.oracle.c		

Access Denied URI:

**Audit**

Debug Level: Error  
 \* Debug Directory: ./amAgent\_logs/debug  
 \* Local Log File: amAgent\_www\_oracle\_com\_80.log

**User Mapping**

Mapping Mode: USER\_ID  
 User Identity: User Token  
 Attribute Name:

**Attribute Mapping**

Profile Attributes		Response Attributes		Session Attributes	
Name	Custom Name	Name	Custom Name	Name	Custom Name
Fetch Mode: NONE		Fetch Mode: NONE		Fetch Mode: NONE	

**Miscellaneous**

Sr. No.	Name	Value
1	com.sun.identity.agents.config.repository	centralized
2	com.sun.identity.agents.config.audit.acce	LOG_NONE
3	com.sun.identity.agents.config.log.dispo	LOCAL
4	com.sun.identity.client.notification.url	http://www.oracle.com:80/agentapp/notification
5	com.sun.identity.agents.config.fqdn.defau	www.oracle.com
6	com.sun.identity.agents.config.load.inter	3600
7	com.sun.identity.agents.config.legacy.red	/agentapp/sunwLegacySupportURI
8	com.sun.identity.agents.polling.interval	3
9	com.sun.identity.policy.client.cacheMode	self
10	com.sun.identity.policy.client.booleanaActi	iPlanetAMWebAgentService GET allow deny:iPlanetAMWebAgentService POST allow deny
11	com.sun.identity.policy.client.resourceCo	serviceType=iPlanetAMWebAgentService class=com.sun.identity.policy.plugins.HttpURLResourceName wildcard=* d
12	com.sun.identity.policy.client.clockSkew	0
13	com.sun.identity.agents.config.change.n	true

### D.3.3 Migrated Authentication Module: OpenSSOAgent1

**Figure D-18 Migrated Authentication Module: OpenSSOAgent1**

**LDAP** LDAP Authentication Module Duplicate Apply

Use the LDAP Authentication module for Basic and Form challenge methods. It matches the credentials (username and password) of the user who requests a resource to a user definition stored in an LDAP directory server.

\* Name

\* User Identity Store

### D.3.4 Migrated Host Identifier: OpenSSOAgent1

**Figure D-19 Migrated Host Identifier: OpenSSOAgent1**

**OpenSSOAgent1** Host Identifier Duplicate Apply

A Host Identifier must be configured for each Web site or virtual Web site that you want to protect with Access Manager. Host identifier simplifies the identification of a Web server host by defining all possible hostname variations.

\* Name

Description

Host Name Variations	
Host Name	Port
OpenSSOAgent1	
www.oracle.com	80
OpenSSOAgent1_OpenSSOAgent1	

### D.3.5 Migrated Application Domain: OpenSSOAgent1

**Figure D-20 Migrated Application Domain: OpenSSOAgent1**

**OpenSSOAgent1-Migrated** Application Domain

Application Domain provides a logical container for resources or sets of resources, and the associated policies that dictate who can access specific protected resources.

Summary Resources Authentication Policies Authorization Policies Token Issuance Policies Administration Apply

\* Name

Description

\* Session Idle Timeout (minutes)

Allow OAuth Token

Allow Session Impersonation

Enable Policy Ordering

## D.3.6 Migrated Resources: OpenSSOAgent1

**Figure D-21 Migrated Resources: OpenSSOAgent1**

**OpenSSOAgent1-Migrated** Application Domain

Application Domain provides a logical container for resources or sets of resources, and the associated policies that dictate who can access specific protected resources.

Summary **Resources** Authentication Policies Authorization Policies Token Issuance Policies Administration

Use the search tool to find an existing Resource or click the New Resource button to create a new one.

**Search**

Resource Type: HTTP  Query String:

Host Identifier:  Authentication Policy:

Resource URL:  Authorization Policy:

**Search Results**

Actions

Row	Resource Type	Host Identifier	Resource URL	Query String	Authentication Policy	Authorization Policy
1	HTTP	OpenSSOAgent1	/*		Protected Resource Policy	Protected Resource Policy

## D.3.7 Migrated Authentication Policy: OpenSSOAgent1

**Figure D-22 Migrated Authentication Policy: OpenSSOAgent1**

**Protected Resource Policy** Authentication Policy

Authentication Policy defines the type of verification that must be performed to provide a sufficient level of trust for Access Manager to grant access to the user making the request. A single policy can be defined to protect one or more resources in the Application Domain.

Name: Protected Resource Policy-Migrated  Success URL:

Description: Policy created for http://openssoagent1.oracle.com  Failure URL:

Authentication Scheme: LDAPScheme

Resources Responses Advanced Rules

**Resources**

Resource Type	Host Identifier	Resource URL	Query String
HTTP	OpenSSOAgent1	/*	

## D.3.8 Migrated Authorization Policy: OpenSSOAgent1

**Figure D-23 Migrated Authorization Policy2 Condition: OpenSSOAgent1**

**Protected Resource Policy-Migrated** Authorization Policy

Authorization policy contains a set of conditions that define whether a user should be permitted or denied access to the resources protected by the policy. Authorization rules and conditions apply to all resources within a specific Authorization policy.

Summary **Resources** Conditions Rules Responses

**Resources**

Resource Type	Host Identifier	Resource URL	Query String	Name Value list	Operations
HTTP	OpenSSOAgent1	/*			All

**Figure D-24 Migrated Authorization Policy2: IP Condition Details**

**Protected Resource Policy-Migrated** Authorization Policy Duplicate Apply

Authorization policy contains a set of conditions that define whether a user should be permitted or denied access to the resources protected by the policy. Authorization rules and conditions apply to all resources within a specific Authorization policy.

Summary Resources **Conditions** Rules Responses

View + Add ✎ Edit ✕ Delete

Name	Type	Description
OpenSSOIPRange1	IP Range	IP Range created for http://openssoagent1.oracle.com
TRUE	True	This condition always evaluates to true.

**Condition Details : OpenSSOIPRange1**

IP Ranges

View + Add ✎ Edit ✕ Delete

From	To
10.0.0.10	10.0.0.50

---

# Troubleshooting

The following topics provide troubleshooting tips:

- [Introduction to Oracle Access Management Troubleshooting](#)
- [My Oracle Support for Additional Troubleshooting Information](#)
- [Oracle Access Management Console Inconsistent State](#)
- [AdminServer Won't Start if the Wrong Java Path Given with WebLogic Server Installation](#)
- [Agent Naming Not Unique](#)
- [Application URL Requirements](#)
- [Authentication Issues](#)
- [Authorization Issues](#)
- [Cannot Access Authentication LDAP or Database](#)
- [Cannot Find Configuration](#)
- [Co-existence Between OSSO and Access Manager](#)
- [Could Not Find Partial Trigger](#)
- [Denial of Service Attacks](#)
- [Deployments with Freshly Installed 10g Webgates](#)
- [Disabling Windows Challenge/Response Authentication on IIS Web Servers](#)
- [Changing UserIdentityStore1 Type Can Lock Out Administrators](#)
- [IIS Web Server Issues](#)
- [jps Logger Class Instantiation Warning is Logged on Authentication](#)
- [Internationalization, Languages, and Translation](#)
- [Login Failure for a Protected Page](#)
- [OAM Metric Persistence Timer IllegalStateException: SafeCluster](#)
- [Partial Cluster Failure and Intermittent Login and Logout Failures](#)
- [RSA SecurID Issues and Logs](#)
- [Registration Issues](#)

- [Rowkey does not have any primary key attributes Error](#)
- [SELinux Issues](#)
- [Session Issues](#)
- [SSL versus Open Communication](#)
- [Start Up Issues](#)
- [Synchronizing OAM Server Clocks](#)
- [Using Coherence](#)
- [Validation Errors](#)
- [Web Server Issues](#)
- [Windows Native Authentication](#)

## E.1 Introduction to Oracle Access Management Troubleshooting

Oracle Access Management is a business critical system; downtime comes with a potentially high cost to your business. The goal of system analysis is to quickly isolate and correct the cause of any problem. This requires a big picture view of your system and the tools to observe the live system and correlate components to the bigger picture.

To assist Administrators in performing a quick diagnosis, this section provides the following topics:

- [System Analysis and Problem Scenarios](#)
- [LDAP Server or Identity Store Issues](#)
- [OAM Server or Host Issues](#)
- [Agent-Side Configuration and Load Issues](#)
- [Runtime Database \(Audit or Session Data\) Issues](#)
- [Change Propagation or Activation Issues](#)
- [Policy Store Database Issues](#)

### E.1.1 System Analysis and Problem Scenarios

System analysis includes understanding how the product works, what can go wrong, how likely the scenarios are, and the consequences or observable issues.

System problems can be divided into two basic categories:

- Cascading catastrophic failure
- Gradual breakdown in performance

Cascading catastrophic failure might be caused by:

- LDAP server is loaded and unresponsive
- Morning peak load starts

- Webgates send requests to the primary OAM Server
- Webgate requests time-out and Webgates retry to secondary OAM Server

Gradual breakdown in performance might occur over time when, for example:

- OAM is sized and rolled out for 10,000 users and 500 groups
- Over the course of a year, the number of users and groups increases significantly (to 50,000 users and 250 groups for example)

For information on the most commonly encountered issues, see the following topics:

- [System Analysis and Problem Scenarios](#)
- [LDAP Server or Identity Store Issues](#)
- [OAM Server or Host Issues](#)
- [Agent-Side Configuration and Load Issues](#)
- [Runtime Database \(Audit or Session Data\) Issues](#)
- [Change Propagation or Activation Issues](#)
- [Policy Store Database Issues](#)

## E.1.2 LDAP Server or Identity Store Issues

This topic provides symptoms, probable cause, and steps to diagnose the following issues:

- [Symptoms: Operational Slowness](#)
- [Symptoms: Total loss of service](#)

### **Symptoms: Operational Slowness**

- Poor user experience
- Agent time outs lead to retries

### **Cause**

- Non-OAM load might be impacting OAM operations
- Capacity problems due to gradual increase in peak load

### **Symptoms: Total loss of service**

Total loss of service

### **Cause**

- Outage of all LDAP servers
- The load balancer is timing out old connections

### **Diagnosis**

1. Shut down the LDAP server.
2. Restart your browser.
3. Try to access a protected site.
4. Review errors in the OAM Server log file, as described in [Logging Component Event Messages](#) (alternatively, in [Monitoring Performance and Logs with Fusion Middleware Control](#)).
5. Try to access Oracle Access Management Console.
6. Observe errors in WebLogic AdminServer log file.
7. Bring up the LDAP server again.
8. Retry access to a protected application.
9. Retry access to the Oracle Access Management Console.
10. Correct the issue based on the requirements in your environment.

### **E.1.3 OAM Server or Host Issues**

This topic provides symptoms, probable cause, and steps to diagnose the following issues:

- [Symptoms: Capacity Problems](#)
- [Symptoms: Interference with Other Services on the Host](#)

#### **Symptoms: Capacity Problems**

- Poor user experience due to slow operations
- Agent time outs and retry can result in extra load

#### **Cause**

- CPU cycles
- Memory issues

#### **Symptoms: Interference with Other Services on the Host**

- Poor user experience due to slow operations
- Agent time outs and retry may result in extra load

#### **Cause**

- CPU cycle contention
- Memory contention
- File system full



**Diagnosis: OAM Server**

1. Shut down the OAM Server
2. Try to access a Webgate or mod\_osso protected resource
3. Bring up the OAM Server
4. Use the Access Tester to test authentication and authorization as described in [Validating Connectivity and Policies Using the Access Tester](#) .
5. Use 'top' to figure out the CPU and Memory consumption of the OAM Server as you use the access tester
6. Get a thread dump of the OAM Server.

**Diagnosis: AdminServer**

1. Shut down the AdminServer.
2. Restart your browser and access a protected resource, which should work.
3. Use remote registration to register a new partner, as described in [Registering and Managing OAM 11g Agents](#) (this should fail).
4. Startup OAM AdminServer.

## E.1.4 Agent-Side Configuration and Load Issues

This topic provides symptoms, probable cause, and steps to diagnose time issues between agents and servers.

**Symptoms**

Difference in Clock time Between Agent and Server

- High CPU usage at both agent and server
- User experiences a system hang

**Cause**

- Agent thinks the token issued by the server is invalid
- Agent keeps going back to the server to re-issue the token

**Diagnosis**

1. Access protected resource.
2. Confirm: Client access hangs.
3. Confirm: High CPU usage on agent and server.

## E.1.5 Runtime Database (Audit or Session Data) Issues

The audit and session functions are both write intensive operations. The policy database can be tuned for read intensive service.

### Symptoms

- Audit and session operations are slow
- File system on the OAM Server is full with audit data that is not yet written to the database
- Loss of in-memory session data when one of the servers in the cluster fails

### Cause

- Database is not tuned for write intensive operations
- Database is unavailable due to maintenance
- Space issues in the database

### Diagnosis

1. Shut down the database used to store Audit and Session data.
2. Try to access a protected resource.
3. Review error and warning messages in the OAM Server log files, as described in [Logging Component Event Messages](#) (alternatively, in [Monitoring Performance and Logs with Fusion Middleware Control](#) ).

## E.1.6 Change Propagation or Activation Issues

This topic provides symptoms, probable cause, and steps to diagnose the following issues:

### Symptoms

- Changes to policy do not take immediate effect
- Changes to system configuration do not take immediate effect

### Cause

- Servers being too busy handling runtime requests (CPU contention)
- Coherence network slowness

### Diagnosis

See "[Policy Store Database Issues](#)"

## E.1.7 Policy Store Database Issues

This topic provides symptoms, probable cause, and steps to diagnose policy database issues.

### Symptoms

No policy changes are allowed; no impact on runtime

**Cause**

- Database is unavailable (down for maintenance)
- Space issues in the database

**Diagnosis**

1. Shut down the database containing OAM policies.
2. Try to access a protected resource and observe the runtime access is not impacted.
3. Try to access the Oracle Access Management Console to edit policies, and then observe errors in the AdminServer log file.

## E.2 My Oracle Support for Additional Troubleshooting Information

You can use My Oracle Support (formerly MetaLink) to help resolve Oracle Fusion Middleware problems. My Oracle Support contains several useful troubleshooting resources, such as:

- Knowledge base articles
- Community forums and discussions
- Patches and upgrades
- Certification information

---

---

**Note:**

You can also use My Oracle Support to log a service request.

---

---

You can access My Oracle Support at <https://support.oracle.com>.

## E.3 Administrator Lockout

**Problem**

Administrator cannot successfully log in to the Oracle Access Management Console. The following message appears:

Manually Change Identity Store Settings at OPSS Level and configure the IDMDomainAgent.

**Cause**

Access Manager secures the Oracle Access Management Console based on authentication information in the IAM Suite Application Domain: OAM Admin Console Policy. This policy relies on a single Authentication Scheme (OAMAdminConsoleScheme), which uses a Form challenge method and LDAP Authentication Module. The LDAP Authentication Module must be pointing to the User Identity Store designated as the System Store.

If, for example, your deployment is configured to use Oracle Internet Directory (with all Administrators, users, and groups defined therein) ensure that the LDAP

Authentication Module points to this user identity store and that this is designated as the System Store.

### Solution

1. Insert a user identity into both your designated system store and the Embedded LDAP store.
2. Log in to Oracle Access Management Console.
3. Configure the LDAP Authentication Module used by the designated System Store to point to the appropriate User Identity Store, as described in "[Managing Native Authentication Modules](#)".

## E.4 Error During Federation Configuration After Upgrade from PS1 to PS2

**IAM Suite** is the OOTB Application Domain created when OAM 11.1.2 is installed. This Application Domain can be renamed after installation but when upgrading OAM to 11.1.2.2.0, it must be renamed back to **IAM Suite**. If it has been renamed, the upgrade operation will fail with this error seen in the WLS admin logs.

```
java.lang.NullPointerException
at
oracle.security.am.common.policy.tools.upgrade.r2ps2.bootstrap.FedR2PS2BootstrapHandler.createFedAuthnResource(FedR2PS2BootstrapHandler.java:505)
at
oracle.security.am.common.policy.tools.upgrade.r2ps2.bootstrap.FedR2PS2BootstrapHandler.doBootstrap(FedR2PS2BootstrapHandler.java:151)
at
oracle.security.am.common.policy.tools.upgrade.r2ps2.bootstrap.R2PS2BootstrapHelper.doBootstrap(R2PS2BootstrapHelper.java:70)
at
oracle.security.am.common.policy.tools.PolicyComponentLifecycle.initialize(PolicyComponentLifecycle.java:99)
```

If the **IAM Suite** Application Domain has been renamed, it is required to rename it back to its original **IAM Suite** name prior to beginning the upgrade process. After the upgrade, the name can be changed back to a custom name.

## E.5 Oracle Access Management Console Inconsistent State

### Problem

Administrators performing updates concurrently will result in an inconsistent state within the system configuration of the Oracle Access Management Console.

### Cause

Concurrent configuration updates are not supported.

### Solution

Only one Administrator should be allowed to modify the system configuration at any given time.

## E.6 AdminServer Won't Start if the Wrong Java Path Given with WebLogic Server Installation

WebLogic Server (wls1035\_generic) installation is successful on Windows 64-bit with 32-bit Java (jdk1.6.0\_24). When setup.exe is executed you must provide the path of the 64-bit java (jdk1.6.0\_23) to successfully launch the install shield.

If you provide the 32-bit Java (jdk1.6.0\_24) path, the install shield is not launched. However, if you execute config.cmd from \Middleware\Oracle\_IDM1\common\bin, by default 32-bit Java (jdk1.6.0\_24) path is used, but after successful installation Access Manager installation, you cannot start AdminServer.

On Windows host, the path to 32-bit JAVA\_HOME (c:\Program files (x86)\java\jdkxxxx) is not correctly handled by the startWeblogic.cmd. Replacing SUN\_JAVA\_HOME to use the path with the shorter name (c:\progra~2\java\jdkxxxx) works fine.

On Windows, the shorter names can be seen by executing "dir /X".

Alternatively, you can set windows cmd shell variable JAVA\_HOME to path with shorter name and execute startWeblogic.cmd within that. For example:

```
>set JAVA_HOME=c:\progra~2\java\jdkXXX
>startweblogic.cmd
```

## E.7 Agent Naming Not Unique

A unique identifying name for each Agent registration is preferred. However:

- If the Agent Name exists, no error occurs and the registration does not fail. Instead, Access Manager creates the policies if they are not already in place.
- If the host identifier exists, the unique Agent Base URL is added to the existing host identifier and registration proceeds.

## E.8 Application URL Requirements

The number of characters allowed in a URL are based on browser version.

The main attribute that affects the size of a cookie is the length of the requested URL. Some of the system generated URLs for ADF applications are quite long and can cause the cookie to exceed the maximum size.

Another case is when using custom plug-ins. The data that a plug-in adds to the authentication context is persisted in the cookie and can cause the cookie size to grow.

Multiple wrong password attempts can also add more context data to the cookie. Combined with one of the above cases, the cookie size can rapidly grow.

### Solutions

Ensure that your applications do not use URLs that exceed the length that Access Manager and the browser can handle.

The cookie cache mode can be changed to FORM mode from default COOKIE mode. FORM mode works with long URLs. The only difference in behavior is for programmatic authentication, which requires a proper form Submit to pass the

OAM\_REQ parameter set to the form. Custom credential collection pages need to handle the OAM\_REQ parameter that is submitted with the form.

Also, to support long URLs, set the `serverRequestCacheType` parameter to `FORM` in `oam-config.xml` under `$DOMAIN_HOME/config/fmwconfig/oam-config.xml`:

```
<Setting Name="serverRequestCacheType"
Type="xsd:string">FORM</Setting>
```

## E.9 Authentication Issues

This section provides the following information:

- [Anonymous Authentication Issues](#)
- [X.509Scheme and SSL Handshake Issues](#)
- [X.509 Protected Resource and Single Sign Off](#)
- [X509CredentialExtractor Certificate Validation Error](#)

### E.9.1 Anonymous Authentication Issues

#### Problem

Challenge Redirect URL can be NULL; however, Challenge Method cannot be NULL.

If you open the Anonymous authentication scheme to edit, and click Apply without adding a value for Challenge method, the following errors might appear:

Messages for this page are listed below.

- \* Challenge Method You must make at least one selection.
- \* Challenge Redirect You must enter a value.

#### Solution

You must include both a challenge method and a challenge redirect whenever you edit an anonymous authentication scheme.

### E.9.2 X.509Scheme and SSL Handshake Issues

The Access Manager X.509 Authentication Scheme relies on SSL to deliver the user's X.509 certificate to the OAM Server. The X.509 Authentication Scheme requires the X.509Plugin as the value of the Challenge Method (not the Authentication Module).

#### Problem

User has selected his certificate in the Browser but the Certificate is not available to the OAM Server.

#### Solution

The specific solution will depend on the reason for the SSL Handshake failure. For instance:

- For debugging SSL connections terminating on the Weblogic Server, please refer to [http://docs.oracle.com/cd/E12840\\_01/wls/docs103/secmanage/ssl.html](http://docs.oracle.com/cd/E12840_01/wls/docs103/secmanage/ssl.html)
- For debugging SSL connections terminating on the OHS server, see [http://docs.oracle.com/cd/E12839\\_01/web.1111/e10144/under\\_mods.htm#i1007687](http://docs.oracle.com/cd/E12839_01/web.1111/e10144/under_mods.htm#i1007687).

Determine the reason for the SSL Handshake failure and the peer that is terminating the SSL Handshake. The solution will fall into the following categories:

- [Configuration Issues](#)
- [Trust Issues](#)
- [Certificate Validation Issues](#)

### E.9.2.1 Configuration Issues

If you are encountering problems establishing a SSL connection with the default WebLogic server SSL implementation, switch to using the JSSE SSL implementation which is supported with WLS 10.3.3+.

The following list identifies other possible configuration issues.

- OHS plugin is incorrectly configured and not sending the user certificate to the WebLogic server.
- Cipher suites: As configured, are not compatible with the user certificate.
- Smart cards: The browser is not communicating with the smart card reader.
- PKCS#11 (or hardware cryptography): Ensure that the devices are in working order.

### E.9.2.2 Trust Issues

The server name within the certificate does not match the host name. This check can be disabled through configuration.

The server does not contain a CA certificate on the user certificate path in its trust store.

### E.9.2.3 Certificate Validation Issues

The following list identifies possible configuration issues.

- Certificate has expired.
- Certificate has been revoked.
- Certificate validation is not working because this is incorrectly configured or there are connectivity issues.

## E.9.3 X.509 Protected Resource and Single Sign Off

### Problem

Single Sign Off might not work after accessing the resource with X.509 authentication. When the user is logged out with the logout URL and tries to access the resource in the

same browser, authentication might not occur. Instead, the user should be asked for authentication using the certificate pop up.

This can occur with any Agent type.

**Solution**

After executing the logout URL, click on Clear SSL State from the browser as follows, and then access the X.509-protected resource:

From the browser window, open the Tools menu, click Internet Options, choose Content, and then Clear SSL state.

## E.9.4 X509CredentialExtractor Certificate Validation Error

**Problem**

Client certificate authentication works fine using the standard X509 Authentication Module after importing the root and sub CA certificates into the WebLogic Server and .oamkeystore keystores.

However, a certificate validation error can occur when using a Custom X509Plugin Authentication Module and root and sub CA certificates into the WebLogic Server and .oamkeystore keystores.

**Solution**

With the Custom X509Plugin Authentication Module the root and sub CA certificates must be added to the DOMAIN\_HOME/config/fmwconfig/amtruststore because the X509CredentialExtractor plug-in loads certificates from this location.

## E.10 Authorization Issues

This section provides the following topics:

- [Authorization Condition Error](#)
- [LDAP Search Filter Test Results](#)
- [Authorization Header Response Names](#)

### E.10.1 Authorization Condition Error

An error is logged in the oam-server diagnostic log file whenever you create or edit an IPv4 range or temporal condition:

```
.... refreshPolicy specified but no response collector supplied
```

**Cause**

This is a message that is erroneously being logged at the ERROR level.

**Solution**

The correct level of the message is INFO.

### E.10.2 LDAP Search Filter Test Results

If too many results are returned, you are informed as follows:



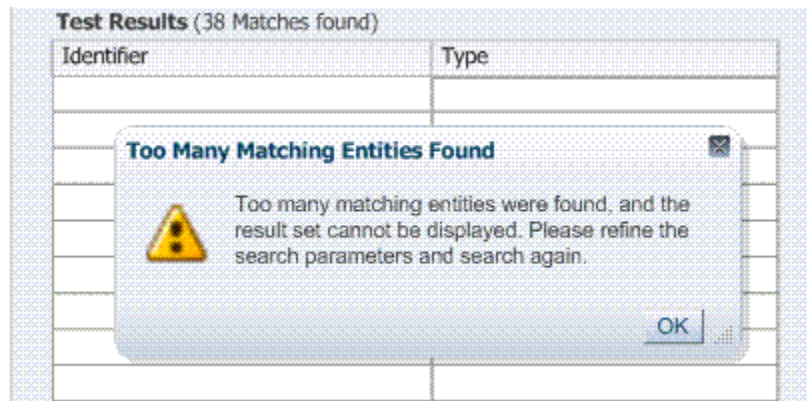

### Solution

1. Click **OK**.
2. Click **Test Filter** to initiate a new test.
3. In the Edit Search Filter dialog, make your changes.
4. Check the Test Results.

## E.10.3 Authorization Header Response Names

Some characters might not be usable within header response names or values, depending on whether the client receiving these responses is a Webgate, and if so which Web server is protected. Certain characters might be subject to automatic conversion to other characters in a server-specific way.

Oracle recommends that you refer to your Web server documentation for more details.

## E.11 Cannot Access Authentication LDAP or Database

If the LDAP directory that is used for authentication is down or inaccessible (or the database that is configured as the policy store), it might be due to a heavy load or a timeout. You see a message when attempting to a protected resource that uses this LDAP or policy store.

### Solution

1. Manually shut down the registered LDAP or database.
2. Restart the registered LDAP or database.

## E.12 Cannot Find Configuration

This section lists the following errors and provides a solution or a workaround.

- [Configuration Does Not Exist ...](#)

### E.12.1 Configuration Does Not Exist ...

If you attempt to create and apply configuration details for an OAM Server before configuring the OAM Server in the WebLogic Server domain, a message informs you of the following:

Configuration does not exist for path  
/DeployedComponent/Server/oamServer/Instance/test

For more information, please see the server's error log for an entry beginning with: Server Exception during PPR, #6.

To resolve this issue, you must configure the OAM Server in the WebLogic Server domain before you register the configuration with Access Manager.

## E.13 Co-existence Between OSSO and Access Manager

### Problem

In the OSSO 10g coexistence with Access Manager 11g, if a user tries to access a protected resource when the OAM server is down, the request is redirected to the OSSO 10g login page through the load balancer. If the user enters valid credentials, the resource is provided.

However, if the user deletes the Oracle HTTP Server cookie and brings the OSSO 10g server down (and brings the OAM Server up), upon accessing the protected resource the user is asked for Access Manager login (authentication). Instead, the application should be accessible without authentication.

### Solution

Confirm that the migrated User Identity Store is set as the Access Manager Default Store and System Store.

---

---

**See Also:** `disableCoexistMode` in *Oracle Fusion Middleware WebLogic Scripting Tool Command Reference*.

---

---

## E.14 Could Not Find Partial Trigger

In the Administration Server output, you might see a "Could Not Find Partial Trigger" error (multiple times for each clicked policy configuration node or host identifier node) and also when you click any of other nodes in the navigation tree. This does not block functionality.

## E.15 Denial of Service Attacks

A denial-of-service attack (DoS attack) or distributed denial-of-service attack (DDoS attack) is an attempt to make a computer resource unavailable to its intended users. One common method of attack involves saturating the target (victim) machine with external communication requests, such that it cannot respond to legitimate traffic, or responds so slowly as to be rendered effectively unavailable.

Denial of service attacks are classified into Authenticated and Unauthenticated Requests, and further classified as:

- NAP Requests
- HTTP Requests

### Authenticated NAP Requests

For Authenticated NAP Requests, the OAM Server maintains a counter in the session and limits the number of retries. Despite this, after redirecting the user to an error page the user can repeat the cycle. This needlessly consumes server resources and can lead to OAM Server overloading.

---

---

**Note:**

To avoid OAM Server overloading with Authenticated NAP Requests, use relevant WebLogic overload configuration settings. These ensure that the server does not crash under load. However, this does not differentiate legitimate users from malicious users.

---

---

### Authenticated HTTP Requests

You can handle a flood of HTTP Authenticated requests with a combination of WebLogic overload configuration and mod\_security module settings.

### Unauthenticated NAP Requests

Unauthenticated NAP Requests are handled by the WebLogic MDB pool throttling. This limits the number of NAP Requests that are forwarded to the OAM Server.

Again, this does not differentiate legitimate users from malicious ones.

### Unauthenticated HTTP Requests

Configuring the mod\_security module for the OHS server that front-ends the OAM Server enables rejection of malicious requests (unauthenticated HTTP Requests).

For more information, see:

- [Protecting the OAM Server from Crashing Under Load](#)
- [Compensating for Network Latency](#)
- [Protecting OAM Servers from a Flood of HTTP Requests](#)

## E.15.1 Protecting the OAM Server from Crashing Under Load

If the number of requests to the OAM Server unexpectedly increases beyond what the server can handle, it could crash.

To limit the number of requests to the OAM Server:

1. In the WebLogic Console, use the Message Driven Bean pool to restrict the number of NAP requests to the OAM Server.

MDBeans pull NAP requests from the Server queue and deliver NAP requests to the Server for processing. Limiting the number of MDBean instances helps control the number of requests that are processed at a given time.

2. In the WebLogic Console, configure the number of WebLogic worker threads that can be used (to restrict the number of requests to the OAM Server).

MDBeans pull NAP requests from the server queue and deliver NAP requests to the Server for processing. Limiting the number of MDBean instances helps control the number of requests that are processed at a given time.

3. In the WebLogic Console, configure the number of WebLogic worker threads that can be used (to restrict the number of requests to the OAM Server).

See the topic on Thread Management in the guide to *Oracle Fusion Middleware Performance and Tuning for Oracle WebLogic Server*.

4. In the WebLogic Console, specify a maximum incoming request size, complete message timeout, and set the number of file descriptors, to optimize performance as described in following topics in the Oracle Fusion Middleware Performance and Tuning for Oracle WebLogic Server:
  - Tuning Message Size
  - Tuning Complete Message Timeout
  - Tuning Number of File Descriptors

## E.15.2 Compensating for Network Latency

Consider the scenario where Webgate sends an authentication request to the OAM Server. After successful credential collection and validation, the OAM Server creates the session and the relevant cookies (OAM\_ID, ObSSOCookie). However, due to network latency, the response times out by the time the OAM Server sends it to the Webgate which triggers Webgate to re-send the authentication request to the Server. The OAM Server recognizes the session, then recreates the ObSSOCookie, and sends the response to the agent. If the network latency persists, the cycle continues in an infinite loop between the Server and the Webgate. The user is neither asked to login again nor presented with an error message.

---

---

**See Also:**

- Controlling Network Latency in *Performance and Tuning Guide*.
  - [Validating Connectivity and Policies Using the Access Tester](#)
- 
- 

## E.15.3 Protecting OAM Servers from a Flood of HTTP Requests

ModSecurity is a Web application firewall (WAF) that can be deployed as part of the existing Apache-based Web server infrastructure. This module can be plugged into the OHS Server that front-ends the OAM Server. In this way, Mod\_security module protects the OAM Server from denial of service attacks.

A flexible rule engine is at the heart of ModSecurity. It implements the ModSecurity Rule Language, a specialized programming language designed to work with HTTP transaction data. A new configuration directive uses the httpd-guardian script to monitor for Denial of Service (DoS) attacks. By default httpd-guardian defends against clients that send more than 120 requests in a minute, or more than 360 requests in five minutes.

---

---

**See Also:**

<http://www.modsecurity.org/documentation/modsecurity-apache/2.5.12/html-multipage/configuration-directives.html#N10689>

---

---

To protect from a flood of HTTP Requests

1. Add the `mod_security` module to the OHS Server that front-ends the OAM Server.
2. In the OHS Server configuration, set the configuration directive to use the `httpd-guardian` script to monitor for Denial of Service (DoS) attacks.

Syntax:

```
SecGuardianLog | /path/to/httpd-guardian
```

Example:

```
SecGuardianLog | /usr/local/apache/bin/httpd-guardian
```

## E.16 Deployments with Freshly Installed 10g Webgates

Use the OAM Server's diagnostic features to debug on the OAM Server side. This section includes the following topics:

- [Authentication Issues with 10g Webgates](#)
- [Logout Issues with 10g Webgates](#)

---



---

**See Also:**

[Configuring Centralized Logout for Sessions Involving 11g WebGates](#)

---



---

### E.16.1 Authentication Issues with 10g Webgates

Use the following methods to troubleshoot authentication issues when you have freshly installed 10g Webgates in your Access Manager deployment.

- Confirm that your request was protected using an `http` header trace like Internet Explorer HTTP Headers or Firefox Live HTTP Headers
- Confirm that the request is sent to the OAM Server for authentication
  - `GET /oam/server/obrareq.cgi?....`
  - `Host: oam-server:port`

### E.16.2 Logout Issues with 10g Webgates

Use the following methods to troubleshoot logout issues when you have freshly installed 10g Webgates in your Access Manager deployment.

- Make liberal use of HTTP Header Trace
- Confirm that the specific `logout.html` was copied to `/access/oamssso` folder in the 10g Webgate installation directory. If not present, you must create the `logout.html` as described in "[Configuring Centralized Logout for 10g WebGate with 11g OAM Servers](#)".
- Change the 10g Webgate's `httpd.conf` to remove the following lines:

```
<LocationMatch "/oamssso/*">
Satisfy any
</LocationMatch>
```

- From the Oracle Access Management Console, confirm that the LogoutUrls parameter (/oamssso/logout.html) is configured for this Webgate

## E.17 Diagnosing Initialization and Performance Issues

This section includes the following topics:

- [Diagnosing an Initialization Issue](#)
- [Diagnosing a Performance Issue](#)
- [Diagnosing Out-of-Memory Issues With a Heap Dump](#)

### E.17.1 Diagnosing an Initialization Issue

#### Problem

OAM Server does not start up.

#### Solution

1. Locate and review the OAM Server log file on the computer hosting the OAM Server.

```
DOMAIN_HOME/servers/SERVER-NAME/logs/SERVER-NAME-diagnostics.log
```

2. Enable logging for this computer, as described in [Logging Component Event Messages](#) :

```
DOMAIN_HOME/config/fmwconfig/servers/SERVER-NAME/logging.xml
```

3. Restart the OAM Server, observe the behavior, check the log file again if needed.

### E.17.2 Diagnosing a Performance Issue

#### Problem

Monitoring the OAM Server reveals a significant spike in latency during authentication.

#### Solution

1. Locate and review the OAM Server log file on the computer hosting the OAM Server.

```
DOMAIN_HOME/servers/SERVER-NAME/logs/SERVER-NAME-diagnostics.log
```

2. Enable logging for this computer, as described in [Logging Component Event Messages](#) :

```
DOMAIN_HOME/config/fmwconfig/servers/SERVER-NAME/logging.xml
```

3. Restart the OAM Server, observe the behavior, check the log file again if needed.

## E.17.3 Diagnosing Out-of-Memory Issues With a Heap Dump

### Problem

Debugging for all expression parsing and evaluation produced a significant performance drag within ~20 hours due to memory growth; running out of memory in ~50 hours.

Configuration: 2GB heap; 3 minute session timeout; jdbc connections tuned min=32 max=200; jdbc connection idle timeout disabled; jbo pool size min = 10 & max=150

### Solution

To generate heap-dumps for comparison, you use the following command-line tools jmap for Sun jvm or jrcmd for jrockit jvm located under JAVA\_HOME/bin.

For jrockit jvm

```
jrcmd pid <command>
/jrockit_160_14_R27.6.5-32/bin/jrcmd 16775 heap_diagnostics
/jrockit_160_14_R27.6.5-32/bin/jrcmd 16775 print_threads
/jrockit_160_14_R27.6.5-32/bin/jrcmd 16775 jrarecording
```

For Sun jvm

```
jmap -histo <pid>
jmap -dump:live,format=b,file=heap.bin <pid>
```

## E.18 Disabling Windows Challenge/Response Authentication on IIS Web Servers

The IIS Web server on Windows supports Challenge/Response Authentication, which defaults to On when IIS is installed. This enables users to use their domain log-ins when requesting resources from IIS and can conflict with Access Manager's authentication.

For example, on the first request from an Internet Explorer (IE) browser to a resource on IIS protected by Access Manager with a basic authentication scheme, IE displays a login dialog box requesting a domain along with the user name and password login provided by Access Manager.

To disable Windows challenge/response authentication

1. Launch the Microsoft Management Console for IIS.
2. Select the Web Server Host under Internet Information Server in the left hand panel.
3. Right click and select **Properties**.
4. Scroll down and select Edit the Master Properties for WWW Service.
5. Select the **Directory Security** tab.
6. Select **Edit Anonymous Access and Authentication Control**.
7. Complete the appropriate step for your platform:  
**Windows 2000:** Clear the Integrate Windows Authentication box.

8. Click **OK**.
9. In the Windows IIS properties screen, click **OK**.
10. Close the Microsoft Management Console.

## E.19 Changing UserIdentityStore1 Type Can Lock Out Administrators

An Identity Store that is designated as the System Store should not be edited to change the store type (from Embedded LDAP to OID, for instance) nor the connection URLs.

If you do need to change the Identity Store that is designated as the System Store should not be edited to change the store type, Oracle recommends that you create a new Identity Store and then edit that registration to mark it as your System Store.

## E.20 IIS Web Server Issues

The following topics are provided to assist you:

- [Form Authentication or Pass-Through Not Working](#)
- [IIS and General Web Component Guidelines](#)
- [Issues with IIS v6 Web Servers](#)
- [Page Cannot Be Displayed Error](#)
- [Removing and Reinstalling IIS DLLs](#)

### E.20.1 Form Authentication or Pass-Through Not Working

If form authentication or pass-through functionality is not working, the problem might be that either "UseWebGateExtForPassthrough" parameter is not set to true in the Webgate profile or that webgate.dll is not configured as Wild Card Application Mapping in IIS. In such cases, Webgate does not perform authentication or authorization for HTTP "POST" requests for the resources protected by form-based authentication.

#### **Solution**

Confirm that the `UseWebGateExtForPassthrough` parameter is configured in the Webgate profile with a value of `true` and that `webgate.dll` is configured as Wild Card Application Mapping.

### E.20.2 IIS and General Web Component Guidelines

Following are some general guidelines to follow when installing Access Manager Webgates with IIS Web servers.

**Account Privileges:** The account that performs Access Manager installation must have administration privileges. The user account that is used to run OAM services must have the "Log on as a service" right, which can be set by selecting **Administrative Tools, Local Policy, Local Policies, User Rights Assignments, Log on as a service**.

**IIS 6 Web Servers:** You must run the WWW service in IIS 5.0 isolation mode. This is required by the ISAPI postgate filter. During Access Manager installation, this is usually set automatically. If it is not, you must set it manually for the Default Web site.



**Webgate for IIS 7 Web Server:** To use Form-based authentication without enabling pass through functionality (for example, "access/oblix/apps/webgate/bin/webgate.dll" is an action in the Form-based authentication scheme), ensure that the entry "<add segment='bin' />" is not present in the applicationHost.config file. If the entry is present, you must remove it. Use the following steps to check this entry:

- Go to Windows\System32\inetsrv\config and open the file applicationHost.config.
- Search for the <hiddenSegments> module and remove the entry <add segment="bin" /> if it is present.

**Webgate:** When installing IIS Webgates, setting various permissions for the /access directory is required for IIS Webgates only when you are installing on a file system that supports NTFS. For example, suppose you install the ISAPI Webgate in Simple or Cert mode on a Windows 2000 computer running the FAT32 file system. The last installation panel provides instructions for manually setting various permissions that cannot be set on the FAT32 file system. In this case, these instructions may be ignored.

### E.20.3 Issues with IIS v6 Web Servers

On IIS 6 Web servers only, you must run the WWW service in IIS 5.0 isolation mode, which is a requirement of the ISAPI postgate filter. This scenario will work if you have 32-bit Access Manager binaries running on a 32-bit Windows operating system. However, there is an issue if you attempt to run a 32-bit postgate.dll on a 64-bit Windows machine with IIS running in 32-bit mode.

#### Problem

When running IIS in IIS5.0 isolation mode, you see the following message:

"ISAPI Filter 'C:\webgate\access\oblix\apps\webgate\bin\webgate.dll' could not be loaded due to a configuration problem.

#### Cause

The current configuration only supports loading images built for an AMD 64-bit processor architecture. The data field contains the error number.

#### Solution

To learn more about this issue, including how to troubleshoot this kind of processor architecture mismatch error, see the following Web site:

<http://go.microsoft.com/fwlink/?LinkId=29349>

For more information, see Help and Support Center at:

<http://go.microsoft.com/fwlink/events.asp>

#### Problem

IIS5 never existed as 64-bit. However, IIS v6's IIS5 Compatibility Mode on 64-bit Windows computers only runs as 64-bit.

#### Cause

It is architecturally impossible run IIS5 Isolation Mode 32-bit on 64-bit Windows, as described in documentation available through the following URLs:

[http://www.microsoft.com/communities/newsgroups/en-us/default.aspx?dg=microsoft.public.inetserver.iis&tid=5dd07102-8896-40cc-86cb-809060fa9426&cat=en\\_US\\_02ceb021-bb43-476d-8f8f-6c00a363ccf5&lang=en&cr=US&p=1](http://www.microsoft.com/communities/newsgroups/en-us/default.aspx?dg=microsoft.public.inetserver.iis&tid=5dd07102-8896-40cc-86cb-809060fa9426&cat=en_US_02ceb021-bb43-476d-8f8f-6c00a363ccf5&lang=en&cr=US&p=1)

<http://blogs.msdn.com/david.wang/archive/2005/12/14/HOWTO-Diagnose-one-cause-of-W3SVC-failing-to-start-with-Win32-Error-193-on-64bit-Windows.aspx>

## E.20.4 Page Cannot Be Displayed Error

A "The page cannot be displayed" error that appears after configuring Webgate for pass-through functionality, indicates a configuration issue.

Solution: Confirm that the `UseWebGateExtForPassthrough` parameter is configured in the Webgate profile with a value of `true` and that `webgate.dll` is configured as Wild Card Application Mapping.

## E.20.5 Removing and Reinstalling IIS DLLs

When Access Manager is running with Microsoft's IIS Web server, you must manually uninstall and reinstall the following ISAPI filters when reinstalling Access Manager.

- `tranfilter.dll`
- `oblixlock.dll` (if you installed Webgate)
- `webgate.dll` (if you installed Webgate)

To remove and reinstall IIS DLLs

1. Uninstall Access Manager.
2. Manually uninstall the preceding DLLs.
3. Reinstall Access Manager.Active Directory.
4. Manually reinstall the DLLs.

---

---

**Note:**

These filters can change depending on the version of IIS you are using. If these filters do not exist or there are others present, contact Oracle to determine if the filters that are present need to be removed.

---

---

## E.21 Import and File Upload Limits

The `UPLOAD_MAX_MEMORY` and `UPLOAD_MAX_DISK_SPACE` is set to "50mb". To upload more than 50mb, manually change these settings in `web.xml`.

To reset the memory and disk space parameters

1. Locate `web.xml` in `WEB-INF/lib/ngam-ui.war`.
2. Edit the file to change `UPLOAD_MAX_MEMORY`. For example:

```
<context-param>
 <param-name>org.apache.myfaces.trinidad.UPLOAD_MAX_MEMORY</param-name>
 <param-value>104857600</param-value>
</context-param>
```

3. Edit the file to change UPLOAD\_MAX\_DISK\_SPACE. For example:

```
<context-param>
 <param-name>org.apache.myfaces.trinidad.UPLOAD_MAX_DISK_SPACE</param-name>
 <param-value>104857600</param-value>
</context-param>
```

4. Save the file.
5. Restart the OAM Server.

---

**See Also:**

"Providing File Upload Capability" in the Oracle Application Development Framework Developer's Guide.

---

## E.22 jps Logger Class Instantiation Warning is Logged on Authentication

A jps logger class instantiation warning might appear on the back end upon authentication. However, this is a harmless warning and no action is required.

## E.23 Internationalization, Languages, and Translation

This section provides the following topics:

- [Automatically Generated Descriptions Are Not Translated](#)
- [Console Looks Messy](#)
- [Authentication Fails: Users with Non-ASCII Characters](#)
- [Access Tester Does Not Work with Non-ASCII Agent Names](#)
- [Locales, Languages, and Oracle Access Management Console Login Page](#)

### E.23.1 Automatically Generated Descriptions Are Not Translated

The automatically generated Description for some components are not translated. This is expected and enables Administrators to change the Description to whatever they require. Following such a change, translation by Oracle is not possible.

### E.23.2 Console Looks Messy

The Oracle Access Management Console displays policies and resources oddly when the input configuration file for remote registration is not in UTF-8 format or when the OAM Server is not started in UTF-8 locale (en\_US.utf8, for instance).

Be sure to use UTF-8 encoding if creating a configuration file for the remote registration tool, oamreg, to generate authentication policies and protected resources. Also, be sure to start OAM Server in UTF-8 locale machines. Otherwise, the Oracle Access Management Console might display policies and resources oddly following successful inband registration.

### E.23.3 Authentication Fails: Users with Non-ASCII Characters

Configure Access Manager to use Kerberos Authentication Scheme with WNA challenge method, and create a non-ASCII user in Microsoft Active Directory.

#### Problem

An exception occurs when trying to get user details to populate the subject with the user DN and GUID attributes. Authentication fails and an error is recorded in the OAM Server log when a non-ASCII user in Active Directory attempts to access an Access Manager-protected resource:

```
... Failure getting users by attribute : cn, value
```

#### Cause

The username in the attribute is passed without modification as a java string.

#### Solution

Non-ASCII users can access the resource protected by Kerberos WNA scheme now by applying this JVM system property (for the built-in WebLogic SPNEGO support):

```
-Dsun.security.krb5.msinterop.kstring=true
```

### E.23.4 Access Tester Does Not Work with Non-ASCII Agent Names

Register a Webgate with Access Manager using a non-ASCII name. In the Access Tester, enter the valid IP Address, Port, and Agent ID (non-ASCII name), then click Connect.

Connection testing fails.

### E.23.5 Locales, Languages, and Oracle Access Management Console Login Page

When the browser locale is not supported, the Oracle Access Management Console Login page shows as server locale. It should fall back to English. This is the expected behavior:

- If the client Locale is not supported, Oracle Access Management falls back to the server locale.
- If the server locale is not supported, Oracle Access Management falls back to English.

When users select an unsupported language and come to the Access Manager SSO page, it shows as server locale (German, for example). However, after logging in, all the pages are displayed as English.

To fall back to English

Disable the Access Manager SSO page and the original Access Manager login page also falls back to English.

## E.24 Login Failure for a Protected Page

### Problem

After installing OAM and protecting a page using a physical host and port, register the application using the OHS physical host and port. Login fails to prompt the user for credentials when accessing the protected page. The log file shows that the URL is re-directed to a Virtual Host despite the fact that all configuration and registration is setup correctly.

### Solution

Remove any Virtual Host Directives from httpd.conf when protecting a page using the Oracle HTTP Server (OHS) physical host and port.

## E.25 OAM Metric Persistence Timer IllegalStateException: SafeCluster

### Problem

After using the WebLogic Configuration Wizard to create an OAM Server cluster on two computers, and starting AdminServer, all servers start up properly. After shut down, a third server is added using the WebLogic Server Administration Console to create a new managed server and add it to the cluster. The third server goes into Running mode when started, with some exceptions in the start up log.

```
... Exception in thread "OAM Metric Persistence Timer"
```

### Solution

in addition to the actions in the WebLogic Administration Console, you must register the server using the Oracle Access Management Console to ensure that the server can identify itself.

---

---

#### Note:

When adding and registering a second server instance for the same computer, all port numbers must differ: OAM Proxy port; the "port" that must match the one in the WebLogic Server Console; and the Coherence port.

---

---

For server registration details, see "[Managing Individual OAM Server Registrations](#)".

## E.26 Partial Cluster Failure and Intermittent Login and Logout Failures

### Problem

In the event of a partial outage of Access Manager (on some, but not all instances of the cluster), end users might see intermittent login and logout failures.

### Workarounds

1. Remove OHS from the deployment

2. Configure the OHS cluster such that each OHS instance is pinned to a WebLogic Server instance.
3. The WebLogic Server container with the malfunctioning Access Manager application must be removed from service (shutdown) and brought back up upon recovery.

## E.27 RSA SecurID Issues and Logs

Each OAM SecurID Server must be registered as a separate agent with the RSA Authentication Manager. This provisions the OAM SecurID Server with its own node secret file. Every OAM SecurID Server must have its configuration file stored under `$DOMAIN_HOME/config/fmwconfig/servers/$SERVER_NAME/oam`.

If the RSA SecurID authentication plug-in returns an error, it is logged in the OAM Server log. Web Server logs can also provide clues as to what might be going wrong. Be sure the enable logging on your Web server.

If communication has been established between the Access Server and Authentication Manager, the `sdadmin` tool provides access to logs under the Report menu. Both Activity and Exception reports may give you helpful information.

### Verify Authentication Manager Logging Configuration and Reports

1. Confirm that you have added the user and assigned a token using the Authentication Manager Administrator tool, `sdadmin`.
2. Verify that you have copied the `sdconf.rec` file to the OAM Server.
3. In the Authentication Manager console, Report menu, open Activity and Exception reports for helpful information.

### Check SecurID Plug-In Parameters with Modified HTML Fields

If you have modified the HTML field names in the HTML forms, ensure that the RSA SecurID plug-in parameters are configured to match.

### Remove the @ character From any Login Attribute Value

User login can fail if there is an at-sign (@) in the login attribute value. This is a known issue with SecurID.

## E.28 Registration Issues

This section provides the following information.

- [Problem: Remote Registration Tool Failure](#)
- [Problem: No ObAccessClient.xml File Generated](#)
- [Problem: Partner Registration Failure](#)

### E.28.1 Problem: Remote Registration Tool Failure

#### Solution

Ensure that the agent name is unique (does not already exist) and that the AdminServer is running.

## E.28.2 Problem: No ObAccessClient.xml File Generated

### Solution

Protected and public resources must be described as relative URLs of the format '/index.html'. If the resource does not begin with a '/', no ObAccessClient.xml file will be generated. Verify the protected and public resource URLs and ensure all begin with a '/'. For more information, see "[Resource URL, Prefixes, and Patterns](#)".

## E.28.3 Problem: Partner Registration Failure

Partner registration can fail if you do not supply a unique agent name, which is also used to create an Application Domain. The agent name and Application Domain name must be the same and must be unique. Using the `oamreg validate` command can fail when the agent name does not match the Application Domain name.

### Solution

Ensure that the agent name and Application Domain name are the same.

## E.29 Rowkey does not have any primary key attributes Error

While browsing across the Resources table in the Resource Type tab the following error message is logged:

```
@ <Error>
<oracle.adfinternal.view.faces.model.binding.CurrencyRowKeySet>
@ <BEA-000000> <ADFv: Rowkey does not have any primary key attributes. Rowkey:
oracle.jbo.Key[], table: model.ResTypeVOImpl@620289.>
```

This is harmless and does not hinder any functionality.

## E.30 SELinux Issues

Delivered with Oracle Enterprise Linux, SELinux modifications provide a variety of policies through the use of Linux Security Modules (LSM) within the Linux kernel.

SELinux requires performing additional steps after installing Access Manager Webgates and before starting the associated Web server.

### Problem

The following errors could be reported in logs/console when starting a Web server on Linux distributions that have more strict SELinux policies in place (after installing an Webgate):

#### 11g Webgate

```
$Webgate_OH/webgate/ohs/lib/webgate.so: cannot restore segment prot after reloc:
Permission denied.
```

#### 10g Webgate

```
$Webgate_install_dir/access/oblix/apps/webgate/bin/webgate.so: cannot restore
segment prot after reloc:
Permission denied.
```

**Cause**

These errors are reported due to Secure Linux security context policies on files.

**Solution**

To avoid these errors and start the Web server, run following `chcon` commands to change the security context on files after installing each Access Manager Web component and before restarting the associated Web server. For more information on the `chcon` command, see your Linux documentation.

1. Run `chcon -t texrel_shlib_t PATH_TO_LIBWEBPLUGINS.SO`. For example:

```
chcon -t texrel_shlib_t /Webgate_install_dir/access/oblix/lib/webgate.so
... and libxmlengine.so
```

2. Run `chcon -t texrel_shlib_t PATH_TO_LIBWEBGATE.SO`. For example:

```
chcon -t texrel_shlib_t /Webgate_install_dir/access/oblix/apps/webgate/
bin/webgate.so
```

## E.31 Session Issues

This section provides the following details:

- [Session Impersonation Not Enabled by Default](#)
- [Sessions with Oracle Access Manager 11.1.1 Integrated with Oracle Identity Federation 11.1.1](#)

### E.31.1 Session Impersonation Not Enabled by Default

Session impersonation is not enabled by default. You can update the value in `oam-config.xml`, then update the version of `oam-config.xml` to automatically propagate the `ImpersonationConfig` status to all managed servers without a restart.

To enable Session Impersonation

1. Back up `DOMAIN_HOME/config/fmwconfig/oam-config.xml`.
2. Set `ImpersonationConfig` to `true`:

```
<Setting Name="ImpersonationConfig" Type="htf:map">
 <Setting Name="EnableImpersonation" Type="xsd:boolean">false</Setting>
</Setting>
```

3. **Configuration Version:** Increment the `Version xsd:integer` as shown in the next to last line of this example (existing value (25, here) + 1):

Example:

```
<Setting Name="Version" Type="xsd:integer">
 <Setting xmlns="http://www.w3.org/2001/XMLSchema"
 Name="NGAMConfiguration" Type="htf:map:>
 <Setting Name="ProductRelease" Type="xsd:string">11.1.1.3</Setting>
 <Setting Name="Version" Type="xsd:integer">25</Setting>
</Setting>
```

4. Save `oam-config.xml`.



## E.31.2 Sessions with Oracle Access Manager 11.1.1 Integrated with Oracle Identity Federation 11.1.1

### Expected Behavior: Oracle Identity Federation 11.1.1 session is not cleared

When Oracle Access Manager 11.1.1 is integrated with Oracle Identity Federation 11.1.1, and you clear the session using the console, only the Oracle Access Manager session is cleared. The Oracle Identity Federation session is not cleared.

## E.32 SSL versus Open Communication

If both the SSL and Open ports of the Managed Server are enabled, then the Managed Server is set to the SSL port by default.

If you must use the non-ssl port, the credential collector URL the authentication scheme must be set to the absolute URL which points to 'http' as the protocol and non-ssl port.

## E.33 Start Up Issues

This section lists the start up issues and its solution.

- [AdminServer Startup \(or Remote Registration Tool Failure\) on AIX Platforms](#)
- [Connection to OAM Server could not be established: Exception in connecting to server. Connection refused.](#)

### E.33.1 AdminServer Startup (or Remote Registration Tool Failure) on AIX Platforms

#### Problem

AdminServer start up fails with following message:

```
"java.net.SocketException:
No buffer space available".
```

Configuration for the number of AIX file descriptors set for the operating system is substantially high (`ulimit` file descriptor) resulting in a buffer overflow that causes remote registration failure with the following message:

The `ulimit` value is application dependent and applies exclusively to application program data and the application stack. The default number of open files setting (2000) is typically sufficient for most applications. If the value is too low, errors might occur when opening files or establishing connections. Because this value limits the number of file descriptors that a server process might open, a value that is too low prevents optimum performance. For the AIX operating system, the default setting is 2000.

#### Solution

Increasing the `ulimit` file descriptor limits might improve performance. Increasing some of the other limits might be needed depending on your application.

1. Log in as root.
2. Perform the following steps to change the open file limit to 10,000 files:

- a. Open the command window.
  - b. Locate and edit `/etc/security/limits` file to add the following lines to the user account on which the AdminServer process runs:

```
nofiles = 10000
nofiles_hard = 10000
```
  - c. Save the file and restart AIX.
3. In a command window, decrease the TCP\_TIMEWAIT interval with the following command to set the state to 15 seconds (which allows TCP to release closed connections faster and increases the number of available resources for open connections).

```
/usr/sbin/no -o tcp_timewait =1
```

4. Tune the following parameters to 256k, as shown:

```
no -a |grep space
tcp_recvspace = 262144
tcp_sendspace = 262144
udp_recvspace = 262144
udp_sendspace = 262144
```

5. Tune the following parameters as indicated here:

```
no -o rfc1323=1
no -o sb_max=4194304
```

### E.33.2 Connection to OAM Server could not be established: Exception in connecting to server. Connection refused.

#### Cause:

This is normal and expected behavior for the Managed Server where the OAM Server runs because the IAMSuiteAgent agent is started before the OAM Server.

The IAMSuiteAgent is deployed on every WebLogic container. When the WebLogic container starts, the agent tries to connect to the OAM Server. If it fails to connect, this message is logged and the agent tries to establish the connection in subsequent requests. When the agent is successful, this message is no longer displayed.

#### Solution

If the connection to the OAM Server is not successful, the IAMSuiteAgent falls back and the WebLogic container handles protection (including login), if it is configured.

## E.34 Synchronizing OAM Server Clocks

The state of a session is the source of truth for relying parties. Synchronization of system clocks of the various Servers is required.

The system clock of the relying party might be out of synchronization with the SME clock. If the relying party's clock is:

- Ahead of the session clock A relying party's request for authentication is made and the active sessionID is returned.

- Behind the session clock: Event notifications to the relying party help invalidate the session.

For example, if a Web server clock is ahead of the server clock, a request sent from the Webgate to the OAM Server will contain a time that, to the OAM Server, has not yet occurred. This can cause login events to fail. When running in Simple or Cert mode, time stamps might become out of sync, or the client certificate might appear to be invalid.

---



---

**Note:**

To avoid event notification issues, ensure that all OAM Server clocks are synchronized to Time Services such as NIST internet time service.

---



---

For successful operation:

- Ensure all computer clocks are synchronized. There is no tolerance level. If, for example, the Webgate clock is even slightly ahead of the OAM Server clock, a cookie generated by the Webgate will appear to be in the future and can cause problems in the OAM Server.
- Confirm that the clock on each computer running a Webgate is *not* running ahead of the OAM Servers with which it is associated. The OAM Server must be ahead of the Webgate clock by a maximum of 60 seconds.

## E.35 Trivial server error popup in Policy Manager

### Problem

When logging into the Policy Manager, you might see the following error message pop-up "Common Server Error."

### Cause

1. Some of the servers may not be up or might not be started appropriately.
2. Network issues while starting the servers.

### Solution

Restart all the servers.

## E.36 Using Coherence

Access Manager uses Oracle Coherence to replicate session states within a distributed installation. Coherence is used to communicate state changes between the Oracle Access Management Console and OAM Servers.

Consider the following 2 distributed deployment topologies. Coherence relies on User Datagram Protocol (UDP) for cluster discovery and heartbeat. If a firewall exists between certain components of Access Manager, then the corresponding UDP ports used by Coherence must be open. Otherwise, Access Manager might not work correctly.

For example, the UDP ports used by Coherence must be opened as follows:

- The Oracle Access Management Console is deployed within the intranet, and OAM Servers are deployed in the DMZ. In this case, the UDP ports used by Coherence must be opened on the firewall between the DMZ and the intranet.
- The Oracle Access Management Console and OAM Servers are deployed in different security zones of the DMZ, with firewalls between any two adjacent zones. In this case, the UDP ports used by Coherence must be opened on the firewall between the adjacent security zones, where one or more instances of Oracle Access Management Console and OAM Servers run.

Access Manager 11g uses Oracle Coherence to provide a distributed cache with low-data access latencies and to transparently move data between distributed caches (and into the session store). Session data is redundant across these tiers. For example, when a session is created, it then exists within the local cache on the server that created it, the distributed cache, and (if enabled) within the session store database as well. For more information, see [Maintaining Access Manager Sessions](#).

---

---

**WARNING:**

Oracle recommends that you do not modify Oracle Coherence settings unless requested to do so by an Oracle Support Representative.

---

---

Whether you are viewing Oracle Coherence settings for an individual server instance or Oracle Coherence details that are common to all OAM Servers, Oracle recommends that you do not modify Oracle Coherence settings unless requested to do so by an Oracle Support Representative.

Oracle Coherence logging appears in the WebLogic Server log only. There is no bridge from Oracle Coherence logging to Access Manager logging.

---

---

**See Also:**

Oracle Coherence documentation.

---

---

## E.37 Validation Errors

The following sections provide information on the Validation Errors and solution to the problems.

- [Resource not added to Authentication or Authorization Policy](#)
- [Validation Failure - "description" attribute is not valid](#)

### E.37.1 Resource not added to Authentication or Authorization Policy

**Problem**

While creating an Authentication or Authorization Policy, if you add a resource that is already used in another Authentication or Authorization Policy, a validation error appears when you click Apply. This is expected.

If you click OK in the error window and then attempt to add a valid resource that is not used within another Authentication or Authorization Policy, the resource is not added and the Authentication or Authorization Policy is not created.

**Solution**

1. Click **Apply** and close the Authentication or Authorization Policy page.
2. From the navigation tree, click the named policy again, click the **Edit** to open the page, and add the new resource.

**E.37.2 Validation Failure - "description" attribute is not valid****Problem**

A validation error appears if you enter an optional description longer than 200 characters.

**Solution**

Keep optional descriptions to 200 characters in length and less than 10 lines.

**E.38 Web Server Issues**

The following issues with Web servers may arise:

- [Server Fails on an Apache Web Server](#)
- [Apache v2 on HP-UX](#)
- [Apache v2 Bundled with Red Hat Enterprise Linux 4](#)
- [Apache v2 Bundled with Security-Enhanced Linux](#)
- [Apache v2 on UNIX with the mpm\\_worker\\_module for Webgate](#)
- [Domino Web Server Issues](#)
- [Errors, Loss of Access, and Unpredictable Behavior](#)
- [Known Issues for ISA Web Server](#)
- [Oracle HTTP Server Fails to Start with LinuxThreads](#)
- [Oracle HTTP Server Webgate Fails to Initialize On Linux Red Hat 4](#)
- [Oracle HTTP Server Web Server Configuration File Issue](#)
- [Issues with IIS v6 Web Servers](#)
- [PCLOSE Error When Starting Sun Web Server](#)
- [Removing and Reinstalling IIS DLLs](#)

**E.38.1 Server Fails on an Apache Web Server****Symptom**

You are running an Apache Web server, and an OAM Server fails, displaying the following message:

```
libthread panic: cannot create new lwp
(PID: 9035 LWP 2). stacktrace:
```

```
ff3424cc
0
```

This symptom may be caused by the Apache Web server launching more instances of itself. This can happen when the server determines that more instances are needed to service the number of connections between one or more Webgates and the OAM Server.

The additional instances create even more connections, which exceed the number of connections by the OAM Server.

### **Solution**

Reduce the number of `MinSpareServers`, `MaxSpareServers`, `StartServers`, and `MaxClients` parameters.

Go to the OAM Server's configuration directory and open the `http.d` configuration file.

Recommended parameter settings:

- `MinSpareServers 1`
- `MaxSpareServers 5`
- `StartServers 3`
- `MaxClients 5`

## **E.38.2 Apache v2 on HP-UX**

When running Apache v2 on HP-UX, do not use `nobody` for User or Group, because shared memory may not work. Instead, use your login name as User Name with a your group as Group Name On HP-UX (on Solaris, "www" is equivalent to "nobody").

When running Apache v2 on HP-UX 11.11, ensure that the `AcceptMutex` directive in the Apache `httpd.conf` file is set to `fcntl`. If the directive is not present, add it to the `httpd.conf` file (`AcceptMutex fcntl`). For more information, see:

[http://issues.apache.org/bugzilla/show\\_bug.cgi?id=22484](http://issues.apache.org/bugzilla/show_bug.cgi?id=22484)

## **E.38.3 Apache v2 Bundled with Red Hat Enterprise Linux 4**

### **Problem**

After installing a Webgate on vendor-bundled Apache, the Web server may give the following error upon startup:

```
Error: Cannot load libgcc_s.so.1 library - Permission denied.
```

### **Solution**

Change the Security-Enhanced Linux (SELinux) policy rules for Access Manager Webgates as described in "[Tuning Apache/IHS v2 Webgates for Access Manager](#)".

## **E.38.4 Apache v2 Bundled with Security-Enhanced Linux**

Errors might be reported in `WebServer logs/console` when starting a Web server on Linux distributions, which have stricter SELinux policies in place, after installing an

Access Manager Web component. You can avoid these errors by running appropriate `chcon` commands for the installed Web component before restarting the Web server.

---



---

**See Also:**

["SELinux Issues"](#)

---



---

### E.38.5 Apache v2 on UNIX with the `mpm_worker_module` for Webgate

The following item is required only if you compile Apache v2 for Webgate on UNIX with the `mpm_worker_module`. In this case, you need to modify the `thread.c` file from the Apache source for the UNIX environment. Making this change ensures that the default `pthread` stacksize for Webgate produces optimal performance during multi-threaded server implementation. If this change is not made, the default `pthread` stack size would not be sufficient for Webgate and could result in a crash.

Apache 2.0 does not support the `ThreadStackSize` option. Therefore:

- With UNIX-based Apache v2.1 and later you must use the `ThreadStackSize` directive to set the size of the stack (for `autodata`) of threads that handle client connections and call modules to help process those connections.
- With UNIX-based Apache 2, it is best to use the compilable source while adding the `mpm_worker_module` and changing the `thread.c` file to avoid a stack overflow.

The following procedure shows how to modify the Apache v2.0 `thread.c` file to provide the default `pthread` stacksize needed by Webgate for optimal performance during multi-threaded server implementation. For details about the Apache v2.1+ `ThreadStackSize` directive, see [http://httpd.apache.org/docs/2.2/mod/mpm\\_common.html#threadstacksize](http://httpd.apache.org/docs/2.2/mod/mpm_common.html#threadstacksize).

---



---

**Note:**

The following procedure should be performed only for the Apache 2.0 Webgate. Otherwise, the default `pthread` stack size is not sufficient for the Webgate and could result in a crash.

---



---

To modify the Apache v2.0 `thread.c` file for Webgate in a UNIX environment

1. Locate the `thread.c` file. For example:

```
APACHE 2.0.52 source/srclib/apr/threadproc/unix/thread.c
```

2. Locate the function named `apr_threadattr_create(apr_threadattr_t **new, apr_pool_t *pool)` in the following code segment:

```
**new, apr_pool_t *pool) in the following code segment:
1-----> apr_status_t stat;
2
3-----> (*new) = (apr_threadattr_t *)apr_palloc(pool,
sizeof(apr_threadattr_t));
4-----> (*new)->attr = (pthread_attr_t *)apr_palloc(pool,
sizeof(pthread_attr_t));
5
6-----> if ((*new) == NULL || (*new)->attr == NULL) {
```

```

7-----> return APR_ENOMEM;
8-----> }
9
10----->(*new)->pool = pool;
11----->stat = pthread_attr_init((*new)->attr);
12
13-----> if (stat == 0) {
14-----> return APR_SUCCESS;
15-----> }
16----->#ifdef PTHREAD_SETS_ERRNO
17----->stat = errno;
18----->#endif
19
20----->return stat;
21

```

3. Add the following code before line 13 shown earlier.

```

int stacksize = 1 << 20;
pthread_attr_setstacksize(&(*new)->attr, stacksize);

```

4. Run configure, make, and make install to set up the Apache Web server with the `mpm_worker_module`.

### E.38.6 Domino Web Server Issues

**Failure Authentication Event:** For Domino Web servers, the redirection of a URL through Access Manager may not work if the authentication type is set as Basic Over LDAP and the URL to be redirected is mentioned as one of the following:

Either a relative path present on the same Web server

Or the Full path URL on the same Web server containing a computer name defined in the host identifier string combinations.

To overcome a failure authentication event, you must set the redirected URL with a computer name that is not defined under the host identifier group. For example, the IP address of the computer.

This problem does not occur with a form-based authentication type.

**Header Variables:** It may not be possible to pass header variables other than `REMOTE_USER` to Webgates installed on Lotus Notes Domino Web servers when using Client Certificate authentication scheme.

For example, header variables cannot be set on the one request where Client Certificate authentication occurs. However, all other requests do allow header variables to be set.

For more information, see [Configuring Lotus Domino Web Servers for 10g WebGates](#).

### E.38.7 Errors, Loss of Access, and Unpredictable Behavior

#### Symptom

If you installed Access Manager on UNIX under a different user ID than you used to create your Web server instance, Access Manager can become unstable. Users may experience behavior such as:

- Random bug report pages
- Failure to write to log file errors



- Loss of access to Web pages

### Solution

Change file permissions using the `chown` command. Change the Access Manager directory to the same user ID that you used to create your Web server instance.

## E.38.8 Known Issues for ISA Web Server

Webgate uses ISAPI extension for displaying user deny error message and for displaying the diagnostic page. However, ISA 2006 does not support extensions. Therefore:

- If the user is denied access by Webgate, the user gets Page Cannot be displayed error message instead of Access Manager denied access error message.
- The following diagnostic URL does not work for ISA: `http(s)://hostname:port/access/oblix/apps/webgate/bin/webgate.dll?progid=1` for webgate.

## E.38.9 Oracle HTTP Server Fails to Start with LinuxThreads

### Problem

After installing a Webgate instance on an Oracle HTTP Server, the server does not start up.

---



---

#### Note:

When running Access Manager, LinuxThreads is used by default. This requires setting the environment variable `LD_ASSUME_KERNEL` to 2.4.19. If you are using NPTL with Access Manager, you do not set `LD_ASSUME_KERNEL` to 2.4.19.9

---



---

### Cause

This occurs because Access Manager uses an older Linux threading model.

### Solution

When using LinuxThreads mode, comment out the Perl module in the `httpd.conf` file, update the `LD_ASSUME_KERNEL` environment variable, and restart, as described in the following procedure.

To resolve the failure to start Oracle HTTP Server in LinuxThreads mode

1. Comment out the perl module in the `httpd.conf` file in the following location:

Oracle HTTP Server 11g: `$ORACLE_INSTANCE/config/OHS/ohs_name/httpd.conf`

Oracle HTTP Server v2: `OH$/ohs/conf/httpd.conf`

Oracle HTTP Server v1.3: `OH$/Apache/Apache/conf/httpd.conf`

2. To update the `LD_ASSUME_KERNEL` value, open the following file in a text editor:

`OH$/opmn/conf/opm.xml`

3. Find the following line:

```
<process-type id="HTTP_Server" module-id="OHS">
```

- 4.

Add the following information under the line you found in the previous step:

```
<environment>
<variable id="LD_ASSUME_KERNEL" value="2.4.19" />
</environment>
```

5. Save this file.

6. Run the following commands to implement your changes:

```
opmnctl stopall
opmnctl startall
```

### E.38.10 Oracle HTTP Server Webgate Fails to Initialize On Linux Red Hat 4

This situation might arise whether you are using Access Manager with LinuxThreads or NPTL.

#### Symptom

Webgate fails to initialize when installed on an Oracle HTTP Server running Red Hat Enterprise Server version 4.0 with a kernel version lower than 2.6.9-34.EL. Version 2.6.9-34.EL is supplied with the Red Hat version 4, update 3.

#### Solution

To prevent this problem, you must upgrade to Red Hat version 4, update 3 or higher.

### E.38.11 Oracle HTTP Server Web Server Configuration File Issue

#### Problem

With Oracle Application Server 10.1.x, OC4J, when the httpd.conf file is modified automatically during Webgate installation, it can be corrupted.

#### Solution

Before installing Webgate, run the following command to prevent the httpd.conf file from being overwritten.

```
$ORACLE_HOME/dcm/bin/dcmctl updateConfig -ct ohs
```

### E.38.12 Issues with IIS v6 Web Servers

On IIS 6 Web servers only, you must run the WWW service in IIS 5.0 isolation mode, which is a requirement of the ISAPI postgate filter. This scenario will work if you have 32-bit Access Manager binaries running on a 32-bit Windows operating system. However, there is an issue if you attempt to run a 32-bit postgate.dll on a 64-bit Windows machine with IIS running in 32-bit mode.

#### Problem

When running IIS in IIS5.0 isolation mode, you see the following message:

"ISAPI Filter 'C:\webgate\access\oblix\apps\webgate\bin\webgate.dll' could not be loaded due to a configuration problem.

### Cause

The current configuration only supports loading images built for an AMD 64-bit processor architecture. The data field contains the error number.

### Solution

To learn more about this issue, including how to troubleshoot this kind of processor architecture mismatch error, see the following Web site:

<http://go.microsoft.com/fwlink/?LinkId=29349>

For more information, see Help and Support Center at:

<http://go.microsoft.com/fwlink/events.asp>

### Problem

IIS5 never existed as 64-bit. However, IIS v6's IIS5 Compatibility Mode on 64-bit Windows computers only runs as 64-bit.

### Cause

It is architecturally impossible run IIS5 Isolation Mode 32-bit on 64-bit Windows, as described in documentation available through the following URLs:

[http://www.microsoft.com/communities/newsgroups/en-us/default.aspx?dg=microsoft.public.inetserver.iis&tid=5dd07102-8896-40cc-86cb-809060fa9426&cat=en\\_US\\_02ceb021-bb43-476d-8f8f-6c00a363ccf5&lang=en&cr=US&p=1](http://www.microsoft.com/communities/newsgroups/en-us/default.aspx?dg=microsoft.public.inetserver.iis&tid=5dd07102-8896-40cc-86cb-809060fa9426&cat=en_US_02ceb021-bb43-476d-8f8f-6c00a363ccf5&lang=en&cr=US&p=1)

<http://blogs.msdn.com/david.wang/archive/2005/12/14/HOWTO-Diagnose-one-cause-of-W3SVC-failing-to-start-with-Win32-Error-193-on-64bit-Windows.aspx>

## E.38.13 PCLOSE Error When Starting Sun Web Server

### Symptom

When attempting to start the Sun Web server, you get an error like the following:

```
Unable to start, PCLOSE
```

### Solution

**Solution:** A number of problems can cause this error:

- A syntax error in your `obj.conf` file
- Leading spaces in your `obj.conf` file
- Installing Access Manager as a different user ID than what you used to create your Web server instance
- A carriage return at the end of the `obj.conf` file

## E.38.14 Removing and Reinstalling IIS DLLs

When Access Manager is running with Microsoft's IIS Web server, you must manually uninstall and reinstall the following ISAPI filters when reinstalling Access Manager.

- `tranfilter.dll`
- `oblixlock.dll` (if you installed Webgate)
- `webgate.dll` (if you installed Webgate)

### To remove and reinstall IIS DLLs

1. Uninstall Access Manager.
2. Manually uninstall the preceding DLLs.
3. Reinstall Access Manager.Active Directory.
4. Manually reinstall the DLLs.

---

---

**Note:**

These filters can change depending on the version of IIS you are using. If these filters do not exist or there are others present, contact Oracle to determine if the filters that are present need to be removed.

---

---

## E.39 Windows Native Authentication

### Problem

After setting up Windows Native Authentication, and accessing the WNA-protected page, the browser might give an error indicating that the user name and/or password are incorrect.

### Cause

The Identity Store used by Oracle Access Management might not point to Windows Active Directory. By default, the identity store is Embedded LDAP.

### Solution

1. In the Oracle Access Management Console, review the identity store configuration: System Configuration, Data Sources, User Identity Store.
2. Confirm the LDAP store settings point to Active Directory.