

Oracle Identity Manager

Version-11.0

9NT1316-ORACLE FCUBSV.UM 11.0.0.0.0.0

[January] [2010]

Oracle Part Number E51712-01



Document Control

Author: Documentation Team	Group: UBPG	
Created on: October 01, 2008	Revision No: Final	
Updated by: Documentation Team	Reviewed by: Development/Testing teams	Approved by: Software Quality Assurance Team
Updated on: January 04, 2010	Reviewed on: January 04, 2010	Approved on: January 04, 2010

Table of Contents

1. ABOUT THIS MANUAL.....	1-1
1.1 INTRODUCTION.....	1-1
1.2 AUDIENCE.....	1-1
1.3 ABBREVIATIONS.....	1-1
1.4 ORGANIZATION.....	1-1
1.4.1 <i>Conventions used in this Manual</i>	1-1
1.5 GLOSSARY OF ICONS.....	1-2
1.5.1 <i>Related Documents</i>	1-3
2. ORACLE FLEXCUBE - ORACLE IDENTITY MANAGER INTERFACE.....	2-1
2.1 INTRODUCTION.....	2-1
2.2 ORACLE FLEXCUBE - ORACLE IDENTITY MANAGER INTEGRATION.....	2-1
2.3 INTEGRATION DEPLOYMENT CONFIGURATION.....	2-1
2.4 OPERATIONS FOR IDENTITY MANAGEMENT.....	2-2
2.5 INTERFACE ATTRIBUTES.....	2-2
2.5.1 <i>Data for User Provisioning</i>	2-2
2.5.2 <i>Data for Reconciliation</i>	2-4
2.6 INTERFACE MAINTENANCES.....	2-5
2.6.1 <i>Maintaining an External Source</i>	2-5
2.6.2 <i>Maintaining OIM Admin User</i>	2-5
3. ANNEXURE A.....	3-1
3.1 INTRODUCTION.....	3-1
3.2 ORACLE IDENTITY MANAGER COMPONENTS.....	3-1
3.3 OIM GENERIC TECHNOLOGY CONNECTOR CONFIGURATION.....	3-1
3.4 SPML REQUEST/RESPONSE MESSAGE FORMATS.....	3-4
3.4.1 <i>Add Request</i>	3-4
3.4.2 <i>Modify Request</i>	3-10
3.4.3 <i>Delete Suspend and Resume Requests</i>	3-12
3.4.4 <i>Set Password Request</i>	3-12
3.4.5 <i>Add and Modify Responses</i>	3-13
3.4.6 <i>Delete Suspend Resume and Set Password Responses</i>	3-15
3.5 MESSAGE EXCHANGE SEQUENCE FOR USER CREATION.....	3-16
3.6 MESSAGE EXCHANGE SEQUENCE FOR USER FIELD MODIFICATION/ SET PASSWORD.....	3-16
3.7 MESSAGE EXCHANGE SEQUENCE FOR USER DELETE / SUSPEND / RESUME.....	3-18

1. About this Manual

1.1 Introduction

This manual talks about the interface between Oracle FLEXCUBE and the Oracle Identity Manager system used in your bank. The maintenances required for the proper functioning of this interface, the interface workflow, validations, and processing for the interface have been documented in this manual.

1.2 Audience

This manual is intended for the following User/User Roles:

Role	Function
Back office data entry Clerks	Input functions for maintenance related to the interface.
Back office Managers/Officers	Authorization functions.

1.3 Abbreviations

Abbreviation	Description
System	Unless specified, it shall always refer to Oracle FLEXCUBE
OIM	Oracle Identity Manager
SPML	Service Provisioning Mark-up Language
DSML	Directory Service Mark-up Language
GTC	Generic Technology Connector

1.4 Organization

This manual is organized into the following chapters:



















Chapter 1	<i>About this Manual</i> gives information on the intended audience. It also lists the various chapters covered in this User Manual.
Chapter 2	<i>Oracle FLEXCUBE – Oracle Identity Manager Interface</i> : Oracle Identity Manager Interface helps in integrating the two systems for user provisioning and de-provisioning services.
Chapter 3	<i>Annexure A</i> - deals with the: OIM Components, SPML Request and Response Message Formats, Message Exchange Sequences.

1.4.1 Conventions used in this Manual

Important information is preceded with the  symbol.

1.5 Glossary of Icons

This User Manual may refer to all or some of the following icons.

Icons	Function
	New
	Copy
	Save
	Delete
	Unlock
	Print
	Close
	Re-open
	Reverse
	Template
	Roll-over
	Hold
	Authorize
	Liquidate
	Exit
	Sign-off
	Help
	Add
	Delete

Refer the Procedures User Manual for further details about the icons.

1.5.1 **Related Documents**

You may refer the following manuals for more information

- Oracle FLEXCUBE manual on Core Entities
- Oracle Identity Manager User Manual (not included with Oracle FLEXCUBE User Manuals)

2. Oracle FLEXCUBE - Oracle Identity Manager Interface

2.1 Introduction

The Oracle FLEXCUBE - Oracle Identity Manager Interface helps in integrating the two systems for user provisioning and de-provisioning services.

Oracle Identity Manager (OIM) automates user provisioning, identity administration, and password management. OIM manages the entire life cycle of user identities and entitlements and helps to control user access across all resources in the organization.

2.2 Oracle FLEXCUBE - Oracle Identity Manager Integration

The integration between Oracle FLEXCUBE and Oracle Identity Manager is done via a Generic Technology Connector (GTC). The GTC provides for provisioning and reconciliation tasks via the following components:

- For Reconciliation
 - Reconciliation Transport Provider moves the reconciled data from Oracle FLEXCUBE into OIM.
 - Reconciliation Format Provider converts the message received from Oracle FLEXCUBE into a format understandable by OIM.
 - Validation Provider validates data received from Oracle FLEXCUBE before passing it on to OIM.
- For Provisioning
 - Provisioning Format Provider (Service Provisioning Markup Language) converts the provisioning data from OIM into a format understood by Oracle FLEXCUBE.
 - Provisioning Transport Provider (web service) carries the provisioning message received from the Provisioning Format Provider to the Oracle FLEXCUBE.

For sample GTC configurations refer Annexure A.

2.3 Integration Deployment Configuration

The OIM- Oracle FLEXCUBE integration is designed to follow a Provisioning and Reconciliation deployment configuration. In this kind of deployment configuration the Oracle Identity Manager performs both provisioning and reconciliation tasks.

The tasks performed by OIM in this deployment configuration are as follows:

- Provisioning tasks of OIM are the creation, maintenance, and deletion of accounts on the Oracle FLEXCUBE system.
- Reconciliation task of OIM is to periodically update the data it maintains with regard to Oracle FLEXCUBE using the data from Oracle FLEXCUBE.

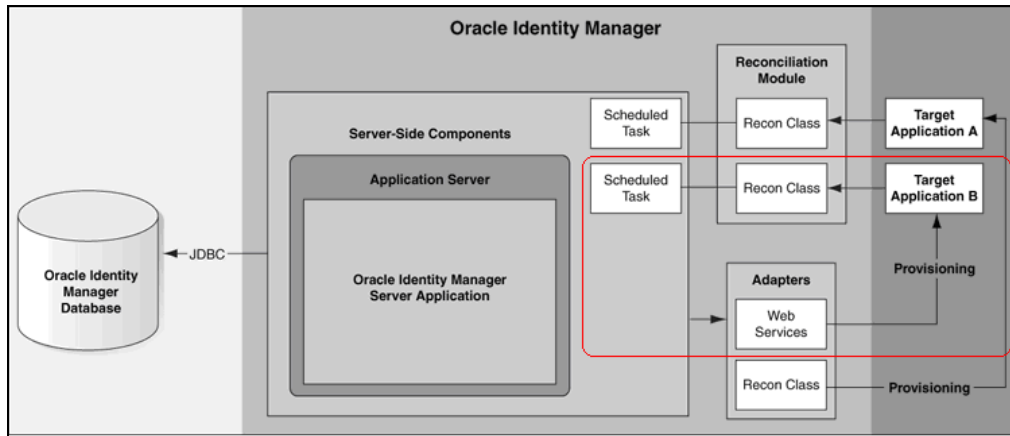

2.4 Operations for Identity Management

You can have certain operations regarding User Identity Management using the OIM GTC. The requests for these operations are sent from OIM GTC and are as follows:

- Add request – For creating a New User Record in Oracle FLEXCUBE
- Modify request – For modifying the existing User Record in Oracle FLEXCUBE
- Suspend request - For closing the respective User record in Oracle FLEXCUBE
- Resume request – For Reopening the Respective User record in Oracle FLEXCUBE
- Delete request – For closing the Respective User record in Oracle FLEXCUBE
- Set Password Request – For changing the Password of the respective user in Oracle FLEXCUBE

2.5 Interface Attributes

OIM GTC is used for both user provisioning/de-provisioning services and for reconciliation in Oracle FLEXCUBE.

For user provisioning and de-provisioning services the Oracle FLEXCUBE Gateway user upload services is used. Reconciliation is done using the 'SMBOIMHF' EOD activity in Oracle FLEXCUBE.



If the Logging Enable property has been selected, then a log file containing OIM request and response with corresponding message id will be maintained in location defined by you.



OIM- Oracle FLEXCUBE integration will remain functional with or without the Oracle FLEXCUBE Single Sign on mode.

For sample GTC configurations refer to Annexure A.

2.5.1 Data for User Provisioning

The data sent from OIM to Oracle FLEXCUBE for user provisioning will contain only the following:

- Mandatory fields for the creation of users in Oracle FLEXCUBE
- External user reference identification containing the OIM id for a user

The data sent from OIM to Oracle FLEXCUBE for user provisioning is illustrated below.

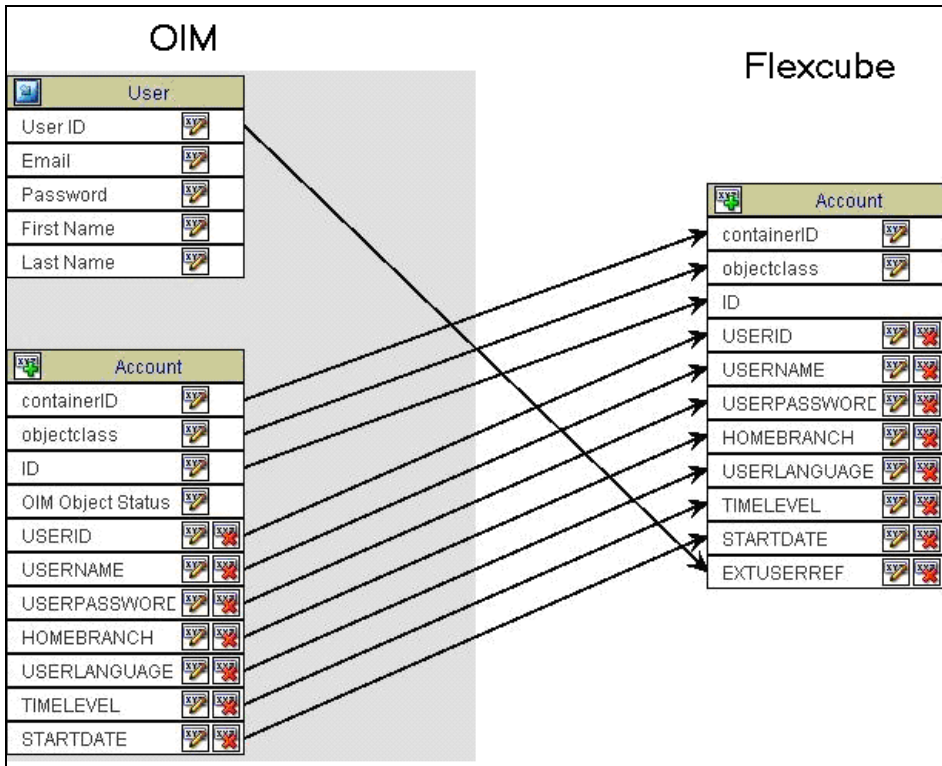

2.5.1.1 Collecting Data for User Provisioning

The data for provisioning is collected from the OIM user creation form. The fields to be collected - such as User ID, User Name and User Password - are defined in the 'Provisioning form for Oracle FLEXCUBE GTC'.

The screenshot shows the 'Provisioning form for FLEXCUBEGTC' in a Microsoft Internet Explorer browser window. The form includes the following fields and values:

- containerID: FLEXCUBEDB
- objectclass: Users
- ID: FXUSER001
- USERID: * FXUSER001
- USERNAME: * FXUSER001
- USERPASSWORD: *
- HOMEBRANCH: * CHO (Clear button)
- USERLANGUAGE: * ENG (Clear button)
- TIMELEVEL: * 9 (Clear button)
- STARTDATE: * June 23, 2008 (Calendar icon)

A 'Save' button is located at the bottom left of the form.

The 'Provisioning form for Oracle FLEXCUBE GTC' is filled up by the OIM Administrator. OIM Administrator uses Direct Provisioning to provision Oracle FLEXCUBE to any OIM user.

The Field values like Name, Password, and User Id in the provisioning data form shall be pre-populated from the OIM user maintenance form.

2.5.1.2 Provisioning Process Flow

The Provisioning process flow is illustrated in the diagram shown below.

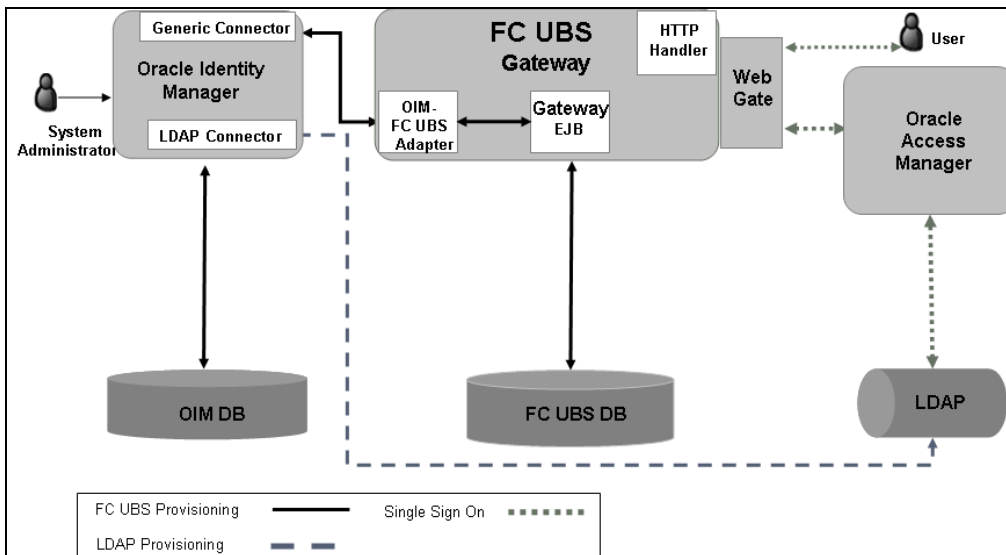

2.5.2 Data for Reconciliation

The data for reconciliation contains the same set of mandatory fields used for user provisioning.

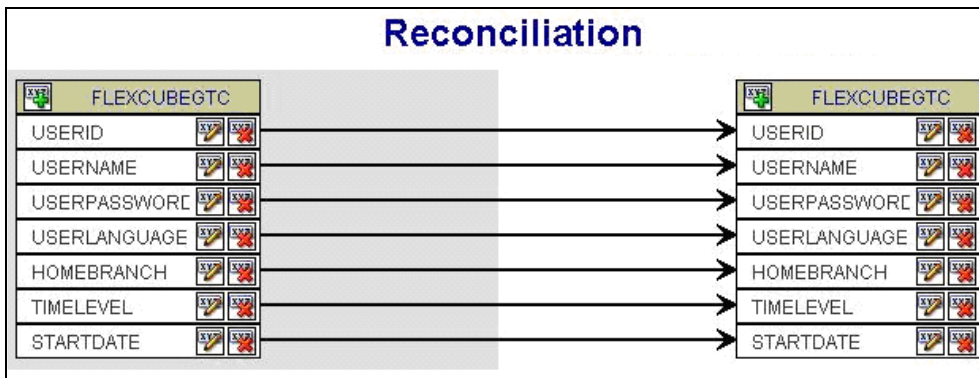

2.5.2.1 Reconciliation File Handoff

The EOD activity 'SMBOIMHF' creates the handoff file for reconciliation. The handoff file will be in CSV (Comma Separated Values) format.

Handoff File Name

The Handoff file name has two parts which are:

- Prefix – SMOIMHOFF
- Suffix – the current date in rrrr-MM-dd format

Handoff File Format

The Handoff file will be in Comma Separated Values (CSV) format and will contain the following:

- First Line - ##FC UBS user data rrrr-MM-dd

- Second line contains comma separated column names
- Third line onwards has the corresponding column values

Sample Handoff file

```
##FC UBS user data 2008-05-06
USERID,USERNAME,USERPASSWORD,TIMELEVEL,HOMEBRANCH,STARTDATE,USERLANGUAGE
TESTUSER1,TEST USER,56A04A86FADBA54D2AD649D98E3FB63F,9,CHO,31-DEC-07,ENG
TESTUSER2,TEST USER,3FE06AFE34C9A53E0320E74E43FB3F45,9,CHO,31-DEC-07,ENG
:
```

2.5.2.2 Reconciliation Process Flow

The Reconciliation process flow is illustrated in the diagram shown below.

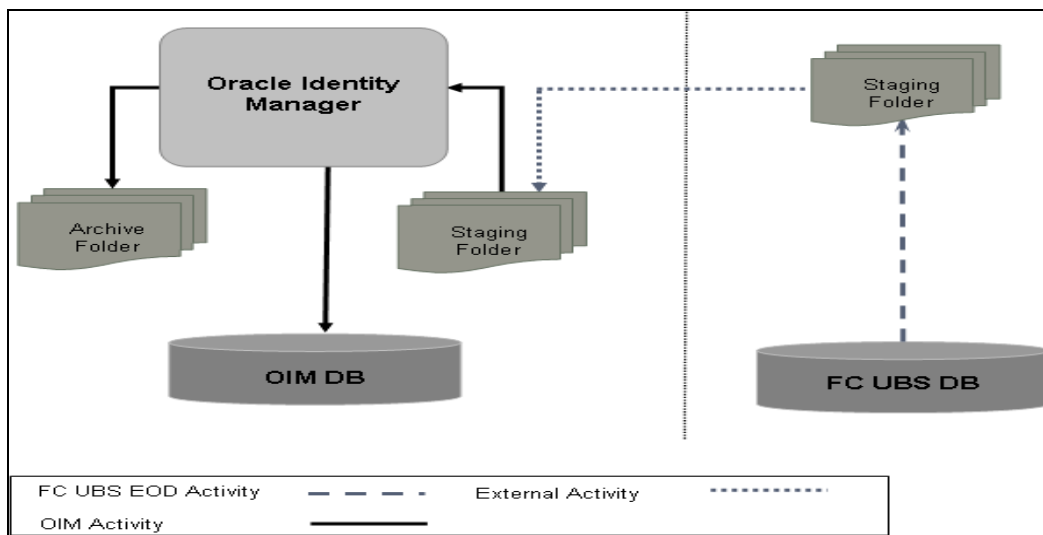

2.6 Interface Maintenances

You have to perform the following maintenances for the OIM – Oracle FLEXCUBE Interface.

2.6.1 Maintaining an External Source

For processing OIM requests, a source named IDM is maintained in Oracle FLEXCUBE. This source has access to Oracle FLEXCUBE Gateway user upload services.

The external source can be maintained in the ‘External System Detailed’ screen. Invoke this screen from under Gateway – External System in the Application Browser.

2.6.2 Maintaining OIM Admin User

You must maintain an ‘OIM Admin User’ in Oracle FLEXCUBE to serve as Maker Id for user provisioning and de-provision. You can maintain the OIM Admin User reference in the ‘External Identifier’ field.

The ‘External Identifier’ field is available in the ‘User Maintenance’ screen where you can maintain other details of the Oracle FLEXCUBE User as well.

User Maintenance -- Web Page Dialog

User Details

Name * OIMTEST OIMTEST MID
OIMTEST LAST

Language * ENG

Home Branch * CHO

Propagate Detailed to Work Flow

Customer Number _____

LDAP DN _____

Time Level * 9

Auto Authorize

User Identification * OIMTEST

External Identifier OIMTEST

User Status

Enabled

Hold

Disabled

Classification

Staff

Customer

Auto End of Day

Branch

Status changed on _____

Last Signed on _____

User Password

Password *

Start Date * 7/3/2000

Password changed on 7/3/2000 12:22:08

End Date _____

Force password change

Invalid Logins

Cumulative _____

Successive _____

Restricted Passwords Roles Rights Functions Tills Account Classes General Ledgers Limits Branches Products Process

Disallowed Functions

Input By SAN3 Date Time 7/3/2000 12:22:08 Modification Number 10 Open

Authorized By SAN3 Date Time 7/3/2000 12:22:08 Authorized

Exit

3. Annexure A

3.1 Introduction

This chapter deals with the following additional information with respect to the Oracle FLEXCUBE – Oracle Identity Manager Interface:

- OIM Components
- SPML Request and Response Message formats
- Message Exchange Sequences

3.2 Oracle Identity Manager Components

Oracle Identity Manager includes the following components:

- User Interfaces – for the user to define and administer the provisioning environment.
- Provisioning Manager – for maintaining provisioning details such as user profiles, access policies, business process workflows and business rules.
- Provisioning Server for the Provisioning Manager
- Adapter Factory – for integrating OIM with other managed systems and application
- Reconciliation Engine - ensures consistency between the provisioning done by OIM and the resources managed by OIM.

The following figure illustrates the various components of the Oracle Identity Manager system.

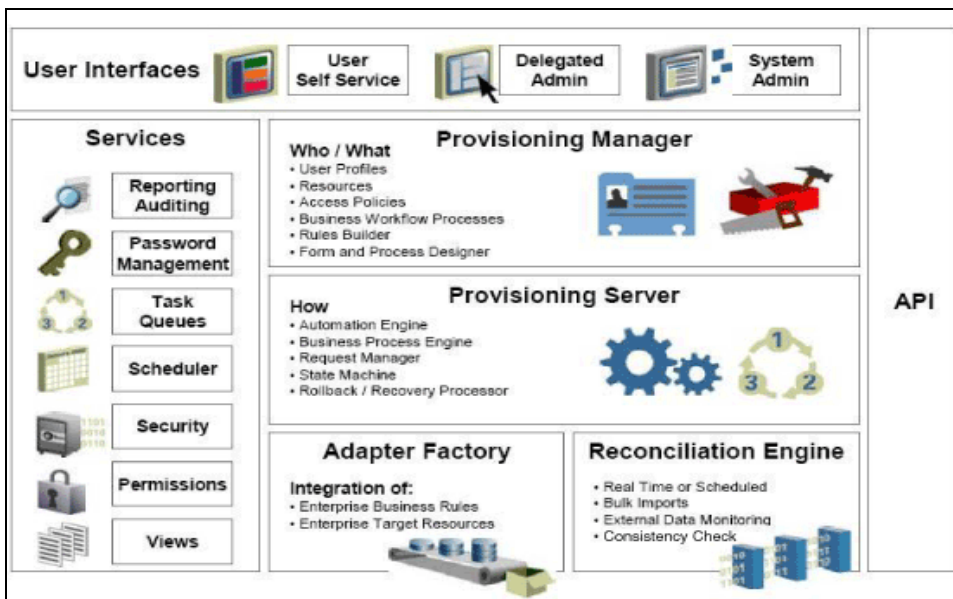

3.3 OIM Generic Technology Connector Configuration

The following table lists the parameter fields and the corresponding sample values for OIM GTC.

Parameter Fields	Sample Value	Remarks
Run-Time Parameters of the Shared Drive Reconciliation Transport Provider		
Staging Directory (Parent Identity Data) field	<OIM_SERVER_HOME\GTC\RECON\STAGING>	Full Path of the data file that contains data to be modified for the Oracle FLEXCUBE User in OIM
Archiving Directory field	<OIM_SERVER_HOME\GTC\RECON\ARCHIVE>	Path to the folder where OIM keeps processed file after reconciliation
File Prefix field	SMOIMHOFF	Prefix of the data file for reconciliation
Specified Delimiter field	,	This (a comma) is only delimiter available with CSV format
Tab Delimiter check box	Check box not selected	NA
Fixed Column Width field	NA	
Specified Delimiter field	NA	
Unique Attribute (Parent Data) field	NA	
Run-Time Parameter of the Web Services Provisioning Transport Provider		
Web Service URL field	http://hostname:port/FCUBSProvisioningAdService/services/FCUBSProvisioningAdServiceSEI	Web service URL of FCUBSProvisioning

Parameter Fields	Sample Value	Remarks
		web service
Run-Time Parameters of the SPML Provisioning Format Provider		
Target ID field	Oracle FLEXCUBE	Will be same as Destination field of FCUBS Header
User Name (authentication) field	NA	
User Password (authentication) field	NA	
Design Parameters of the Shared Drive Reconciliation Transport Provider		
File Encoding field	Cp1251	Canonical name for character set encoding for operating system with the English-language setting for the corresponding java.io API supported by OIM GTC
Design Parameters of the Web Services Provisioning Transport Provider		
Web Service SOAP Action field	http:// spmladapter.ws.oim.integration.fcubs.iflex.com /processRequest	Will be same as defined in corresponding WSDL
Design Parameters of the SPML Provisioning Format Provider		
WSSE Configured for SPML Web Service? check box	Check box not selected	There will be No support for WSSE
Custom Authentication	http:// spmladapter.ws.oim.integration.fcubs.iflex.com	Target Namespace value of

Parameter Fields	Sample Value	Remarks
Credentials Namespace field		corresponding WSDL
Custom Authentication Header Element field	OIMUser	Tag name in Soap Header that will carry user information provided above
Custom Element to Store User Name field	OIMUserId	Do
Custom Element to Store Password field	OIMUserPassword	Do
SPML Web Service Binding Style (DOCUMENT or RPC) field	DOCUMENT	Binding style of Corresponding web service
SPML Web Service Complex Data Type field	FCCProvisioningDocument	Complex data type name defined in Corresponding WSDL
SPML Web Service Operation Name field	NA	Operation name defined in Corresponding WSDL
SPML Web Service Target Namespace field	http:// spmladapter.ws.oim.integration.fcubs.iflex.com	Target Namespace value of corresponding WSDL
SPML Web Service Soap Message Body Prefix field		NA
ID Attribute for Child Dataset Holding Group Membership Information field		NA
Generic Design Parameters		
Target Date	yyyy-MM-dd	Will be same as the

Parameter Fields	Sample Value	Remarks
Format field		Oracle FLEXCUBE Date Format
Batch Size field	All	
Stop Reconciliation Threshold field	None	
Stop Threshold Minimum Records field	None	
Source Date Format field	yyyy-MM-dd	Will be same as the Oracle FLEXCUBE Date Format
Reconcile Deletion of Multi valued Attribute Data check box	Check Box not selected	As no child data is configured
Reconciliation Type list	Full	Reconcile all accounts in Oracle FLEXCUBE that are given into staging data files into the Oracle Identity Manager

3.4 **SPML Request/Response Message Formats**

3.4.1 **Add Request**

This request contains all the data about users. For a Oracle FLEXCUBE user creation, only mandatory fields will be sent in the request.

Sample Request

```
<addRequest returnData="identifier" targetID="FLEXCUBE">
<containerID ID="FLEXCUBEDB" targetID=" FLEXCUBE "/>
<data>
<dsml:attr name="objectclass">
```

```
<dsml:value>Users</dsml:value>
</dsml:attr>
<dsml:attr name="USERID">
<dsml:value>value</dsml:value>
</dsml:attr>
<dsml:attr name="USERNAME">
<dsml:value>value</dsml:value>
</dsml:attr>
<dsml:attr name="USERPASSWORDNAME">
<dsml:value>value</dsml:value>
</dsml:attr>
<dsml:attr name="USERLANGUAGENAME">
<dsml:value>value</dsml:value>
</dsml:attr>
<dsml:attr name="TIMELEVEL">
<dsml:value>value</dsml:value>
</dsml:attr>
<dsml:attr name="HOMEBRANCH">
<dsml:value>value</dsml:value>
</dsml:attr>
<dsml:attr name="STARTDATE">
<dsml:value>value</dsml:value>
</dsml:attr>
<dsml:attr name="EXTUSERREF">
<dsml:value>value</dsml:value>
</dsml:attr>
</data>
```

</addRequest>

Field Tag	Field Type	Field Description	Restrictions	Remarks
addRequest ::	Element	Start tag for create user request		
addRequest : targetID	Attribute	Defines the Target system id on which user is to be created	String	This value will be defined as Oracle FLEXCUBE while configuring Generic connector in OIM. This will be provided as the destination tag value in the Header part of the Oracle FLEXCUBE Gateway request.
addRequest : returnData	Attribute	Defines ReturnDataType	Identifier	For identifier return data type, only PSO ID will be sent as the OIM response content.
addRequest :: containerID	Element	Identifies an object that exists on the target		
addRequest :: containerID : ID	Attribute	The value of ID uniquely identifies an object within the namespace of the target specified by the "targetID"	String	This value will be defined as FLEXCUBEDB while configuration of Generic connector in OIM.
addRequest :: containerID : targetID	Attribute	Defines the Target system id on which user is to be created	string	This value will be defined as Oracle FLEXCUBE while configuring GTC in OIM.
addRequest :: data	Element	This Node contains the User details	Extensible	
addRequest :: data :: dsml:attr :	Element	Contains user field as attribute		

Field Tag	Field Type	Field Description	Restrictions	Remarks
addRequest :: data :: dsml:attr :: name= objectclass	Attribute	This defines the group to which user belongs.		Not Used (Needed for compliance with SPML format)
addRequest :: data :: dsml:attr : dsml:value	Element	Users		This value will be defined as Users while configuration of GTC in OIM.
addRequest :: data :: dsml:attr :	Element	Contains user field as attribute		
addRequest :: data :: dsml:attr :: name= USERID	Attribute	User identifier that is to be created in Oracle FLEXCUBE		This field is mapped as the USERID column of an Oracle FLEXCUBE User account.
addRequest :: data :: dsml:attr : dsml:value	Element	User identifier value	Date Type: String, Length:12	
addRequest :: data :: dsml:attr :	Element	Contains user field as attribute		
addRequest :: data :: dsml:attr :: name= USERNAME	Attribute	User Name		This field is mapped as the USERNAME column of an Oracle FLEXCUBE User account.

Field Tag	Field Type	Field Description	Restrictions	Remarks
addRequest :: data :: dsml:attr : dsml:value	Element	value	Date Type: String, Length:35	
addRequest :: data :: dsml:attr :	Element	Contains user field as attribute		
addRequest :: data :: dsml:attr :: name= USERPASSWORD	Attribute	User Password		This field is mapped as the USERPASSWORD column of an Oracle FLEXCUBE User account.
addRequest :: data :: dsml:attr : dsml:value	Element	value	Date Type: String, Length:32	
addRequest :: data :: dsml:attr :	Element	Contains user field as attribute		
addRequest :: data :: dsml:attr :: name= STARTDATE	Attribute	User Account Start Date		This field is mapped as the STARTDATE column of an Oracle FLEXCUBE User account.
addRequest :: data :: dsml:attr : dsml:value	Element	value		
addRequest :: data ::	Element	Contains user field as attribute		

Field Tag	Field Type	Field Description	Restrictions	Remarks
dsml:attr :				
addRequest :: data :: dsml:attr :: name= TIMELEVEL	Attribute	User Time Level	Data Type: String Length:1	This field is mapped as the TIMELEVEL column of an Oracle FLEXCUBE User account.
addRequest :: data :: dsml:attr : dsml:value	Element	value		
addRequest :: data :: dsml:attr :	Element	Contains user field as attribute		
addRequest :: data :: dsml:attr :: name= HOMEBRANCH	Attribute	User Home Branch code	Data Type: String Length:3	This field is mapped as the HOMEBRANCH column of an Oracle FLEXCUBE User account.
addRequest :: data :: dsml:attr : dsml:value	Element	value		
addRequest :: data :: dsml:attr :	Element	Contains user field as attribute		
addRequest :: data :: dsml:attr :: name=	Attribute	User Language		This field is mapped as the USERLANGUAGE column of an Oracle FLEXCUBE User account.

Field Tag	Field Type	Field Description	Restrictions	Remarks
USERLANGUAGE				
addRequest :: data :: dsml:attr : dsml:value	Element	value	Data Type: String Length:3	
addRequest :: data :: dsml:attr :	Element	Contains user field as attribute		
addRequest :: data :: dsml:attr :: name= EXTUSERREF	Attribute	EXTUSERREF		This field is mapped as the EXT_USER_REF Column of an Oracle FLEXCUBE User account.
addRequest :: data :: dsml:attr : dsml:value	Element	value	Data Type: String Length:20	

3.4.2 Modify Request

A sample Modify request is given below:

```

<modifyRequest returnData="identifier">
<psoid ID="FLXUSER1" targetID=" FLEXCUBE">
</psoid>
<modification>
<dsml:modification name="<Field Name>" operation="replace">
<dsml:value>value</dsml:value>
</dsml:modification>
</modification>
</modifyRequest>

```

Field Tag	Field Type	Field Description	Restrictions	Remarks
modifyRequest	Element	Start tag to modify field request		
modifyRequest : returnData	Attribute	Defines ReturnDataType	Identifier	For identifier return data type, only PSO ID will be sent as the OIM response content
modifyRequest :: psolD	Element	Identifies user in the Oracle FLEXCUBE	String	This will be mapped with the User Id column of Oracle FLEXCUBE
modifyRequest :: psolD : ID	Attribute	User Id Value	Data Type: String Length: 12	This will be used to identify a user in Oracle FLEXCUBE
modifyRequest :: psolD : targetID	Attribute	Defines the Target system id on which user field is to be modified	string	This value will be defined as Oracle FLEXCUBE while configuring GTC in OIM. This will be provided as destination tag value in Header part of the Oracle FLEXCUBE Gateway request.
modifyRequest :: modification	Element	Parent tag for data to be modified		
modifyRequest :: dsml:modification:	Element	Contains data to be modified		
modifyRequest :: dsml:modification: name	Attribute	User field name that needs to be modified		This will be used to identify the column name in Oracle FLEXCUBE
modifyRequest :: dsml:modification: operation	Attribute	Defines modification mode type	Add/replace	An Oracle FLEXCUBE Gateway modify request will be sent for the field
modifyRequest ::	Element	Contains field value to be modified		

Field Tag	Field Type	Field Description	Restrictions	Remarks
modification :: dsml:modification: dsml:value				

3.4.3 Delete Suspend and Resume Requests

The message format is same for suspend and resume request with their respective start tag.

Sample Request

```
<deleteRequest>
<psolD ID="<User Identifier>" targetID=" FLEXCUBE">
</psolD>
</deleteRequest>
```

Field Tag	Field Type	Field Description	Restrictions	Remarks
deleteRequest::	Element	Start tag		
deleteRequest:: psolD	Element	Identifies the user in Oracle FLEXCUBE	String	This will be mapped with the User Id column of Oracle FLEXCUBE
deleteRequest:: psolD : ID	Attribute	User Id Value	Data Type: String Length: 12	This will be used to identify a user in Oracle FLEXCUBE
deleteRequest:: psolD : targetID	Attribute	Defines the Target system id on which user field is to be modified	string	This value will be defined as Oracle FLEXCUBE while configuring GTC in OIM. This will be provided as destination tag value in Header part of the Oracle FLEXCUBE Gateway request.

3.4.4 Set Password Request

The following is a sample Set Password Request.

```
<setPasswordRequest xmlns="urn:oasis:names:tc:SPML:2:0:password">
<psolD ID="<User Identifier>" />
```

<password>password2</password>

</setPasswordRequest>

Field Tag	Field Type	Field Description	Restrictions	Remarks
setPasswordRequest ::	Element	Start tag		
setPasswordRequest :: psolID	Element	Identifies a user in Oracle FLEXCUBE	String	This will be mapped with the User Id column of Oracle FLEXCUBE
setPasswordRequest :: psolID : ID	Attribute	User Id Value	Data Type: String Length: 12	This will be used to identify a user in Oracle FLEXCUBE
setPasswordRequest :: password	Element	Contains the password to be set	Data Type: String Length: 32	This will be mapped with the user_password column of Oracle FLEXCUBE .

3.4.5 Add and Modify Responses

The Add and Modify messages have the same format is same except for their respective start tags.

Sample for successful response

```
< addResponse status="success">
```

```
< pso>
```

```
< psolID ID="<USER ID>" />
```

```
</pso>
```

```
</addResponse>
```

Sample for unsuccessful response

```
< addResponse status="failure" error="alreadyExists">
```

```
< errorMessage>
```

```
exception=tcDuplicateUserException;errorMessage=User already exists
```

```
</ errorMessage>
```

```
</ addResponse>
```

Field Tag	Field Type	Field Description	Restrictions	Remarks
addResponse :	Element	Root Tag		
addResponse : status	Attribute	Defines the status of request	success failure	This will be used to convey the success or failure of the request to OIM.
addResponse :: error	Attribute	Defines the error code	malformedRequest unsupportedOperation unsupportedIdentifierType noSuchIdentifier customError unsupportedExecutionMode invalidContainment noSuchRequest unsupportedSelectionType resultSetTooLarge unsupportedProfile invalidIdentifier alreadyExists containerNotEmpty	In case of failure status appropriate SPML code will be decided and sent to the OIM
addResponse :: errorMessage	Element	Contains the error description		In case of failure status this will contain the description of error code.
addResponse :: pso	Element	Identifies user in Oracle FLEXCUBE	String	
addResponse :: pso: psoID	Attribute	User Id Value	Data Type: String Length: 12	This will be same as sent in request to identify user in OIM.

3.4.6 Delete Suspend Resume and Set Password Responses

Message format is the same for suspend and resume responses except for their respective start tags.

Sample for successful response

```
<deleteResponse status="success"/>
```

Sample for unsuccessful response

```
< deleteResponse status="failure" error=" noSuchIdentifier ">
```

```
< errorMessage>
```

```
exception= tcDuplicateUserException;errorMessage=User not found
```

```
</ errorMessage>
```

```
</ deleteResponse >
```

Field Tag	Field Type	Field Description	Restrictions	Remarks
deleteResponse :	Element	Root Tag		
deleteResponse : status	Attribute	Defines the status of request	success failure	This will be used to convey the success or failure of the request to OIM
deleteResponse :: error	Attribute	Defines the error code Note: Applicable when status is failure	malformedRequest unsupportedOperation unsupportedIdentifierType noSuchIdentifier customError unsupportedExecutionMode invalidContainment noSuchRequest unsupportedSelectionType resultSetTooLarge unsupportedProfile invalidIdentifier alreadyExists containerNotEmpty	In case of failure status appropriate SPML code will be decided and sent to the OIM

Field Tag	Field Type	Field Description	Restrictions	Remarks
deleteResponse :: errorMessage	Element	Contains the error description		In case of failure status this will contain the description of error code.

3.5 Message Exchange Sequence for User Creation

The following diagram illustrates the messages exchange sequence during user creation.

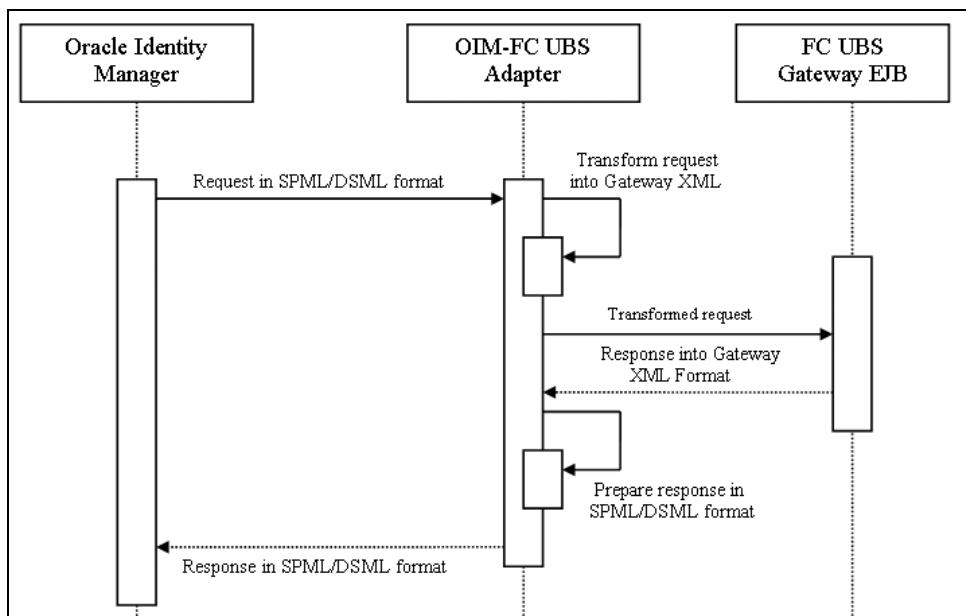

3.6 Message Exchange Sequence for User Field Modification/ Set Password

The following diagram illustrates the messages exchange sequence during user field modification and set password.

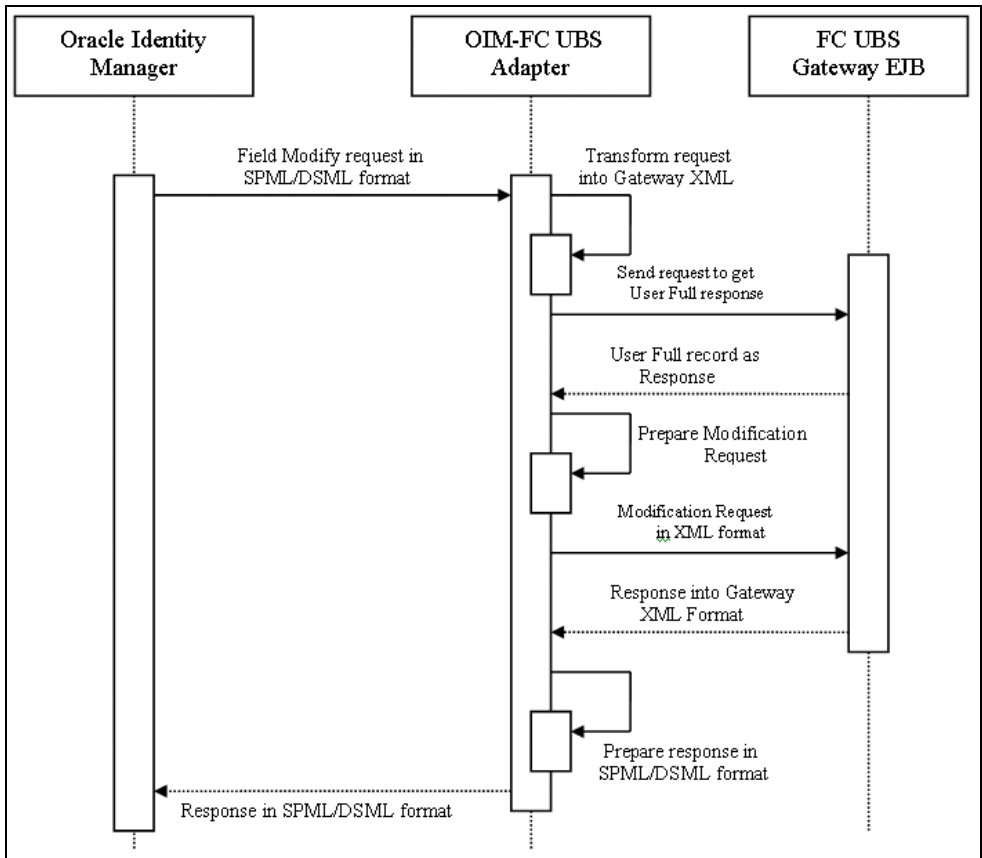

3.7 Message Exchange Sequence for User Delete / Suspend / Resume

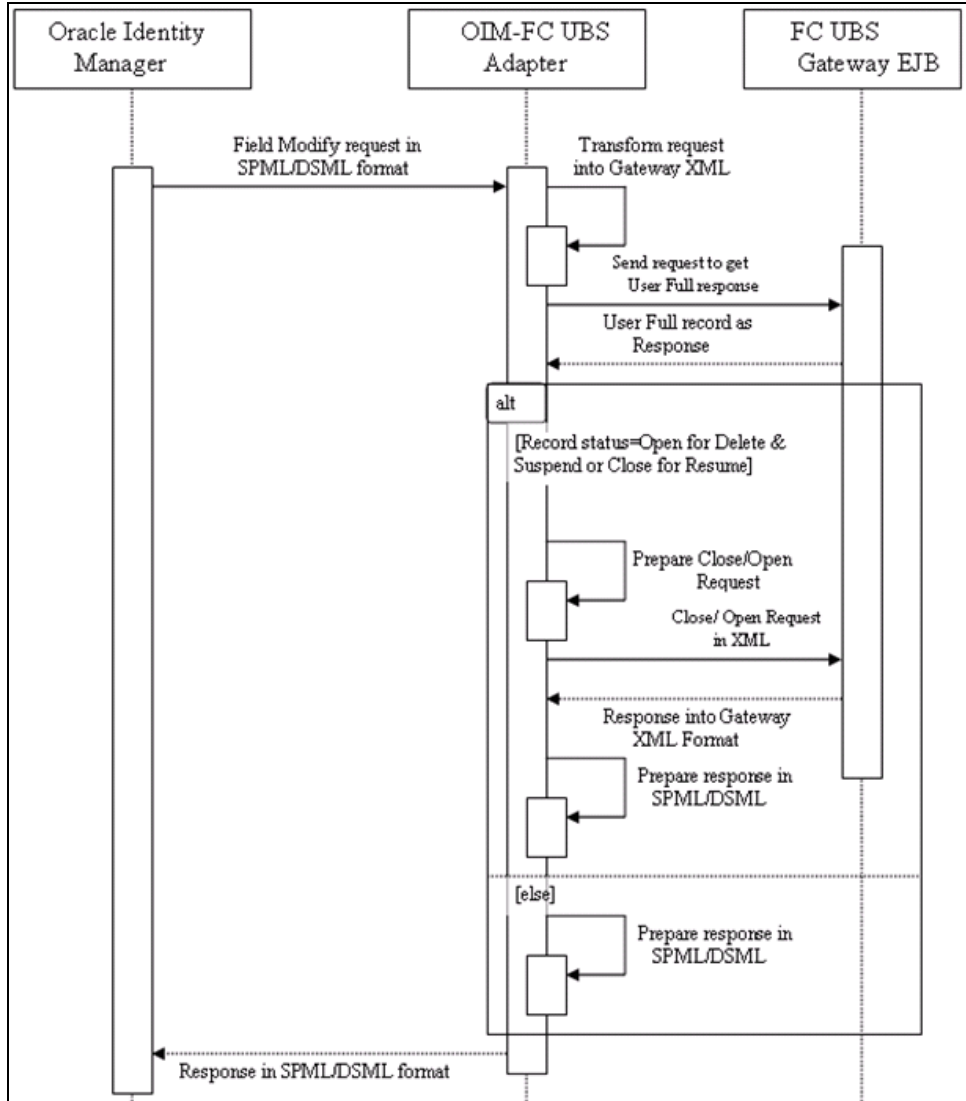



Oracle Identity Manager
[January] [2010]
Version 11.0

Oracle Corporation
World Headquarters
500 Oracle Parkway
Redwood Shores, CA 94065
U.S.A.

Worldwide Inquiries:
Phone: +1.650.506.7000
Fax: +1.650.506.7200
[www.oracle.com/ financial_services/](http://www.oracle.com/financial_services/)

Copyright © [2010] Oracle Financial Services Software Limited. All rights reserved.

No part of this work may be reproduced, stored in a retrieval system, adopted or transmitted in any form or by any means, electronic, mechanical, photographic, graphic, optic recording or otherwise, translated in any language or computer language, without the prior written permission of Oracle Financial Services Software Limited.

Due care has been taken to make this document and accompanying software package as accurate as possible. However, Oracle Financial Services Software Limited makes no representation or warranties with respect to the contents hereof and shall not be responsible for any loss or damage caused to the user by the direct or indirect use of this document and the accompanying Software System. Furthermore, Oracle Financial Services Software Limited reserves the right to alter, modify or otherwise change in any manner the content hereof, without obligation of Oracle Financial Services Software Limited to notify any person of such revision or changes.

All company and product names are trademarks of the respective companies with which they are associated.