

## **Oracle® Fusion Middleware**

Extending the Administration Console for Oracle WebLogic  
Server

12c Release 1 (12.1.1)

**E24966-01**

December 2011

This document tells how to extend the Oracle WebLogic  
Server Administration Console, change the Look and Feel,  
and add help for console extensions.

Oracle Fusion Middleware Extending the Administration Console for Oracle WebLogic Server, 12c Release 1 (12.1.1)

E24966-01

Copyright © 2001, 2011, Oracle and/or its affiliates. All rights reserved.

This software and related documentation are provided under a license agreement containing restrictions on use and disclosure and are protected by intellectual property laws. Except as expressly permitted in your license agreement or allowed by law, you may not use, copy, reproduce, translate, broadcast, modify, license, transmit, distribute, exhibit, perform, publish, or display any part, in any form, or by any means. Reverse engineering, disassembly, or decompilation of this software, unless required by law for interoperability, is prohibited.

The information contained herein is subject to change without notice and is not warranted to be error-free. If you find any errors, please report them to us in writing.

If this is software or related documentation that is delivered to the U.S. Government or anyone licensing it on behalf of the U.S. Government, the following notice is applicable:

U.S. GOVERNMENT RIGHTS Programs, software, databases, and related documentation and technical data delivered to U.S. Government customers are "commercial computer software" or "commercial technical data" pursuant to the applicable Federal Acquisition Regulation and agency-specific supplemental regulations. As such, the use, duplication, disclosure, modification, and adaptation shall be subject to the restrictions and license terms set forth in the applicable Government contract, and, to the extent applicable by the terms of the Government contract, the additional rights set forth in FAR 52.227-19, Commercial Computer Software License (December 2007). Oracle America, Inc., 500 Oracle Parkway, Redwood City, CA 94065.

This software or hardware is developed for general use in a variety of information management applications. It is not developed or intended for use in any inherently dangerous applications, including applications that may create a risk of personal injury. If you use this software or hardware in dangerous applications, then you shall be responsible to take all appropriate fail-safe, backup, redundancy, and other measures to ensure its safe use. Oracle Corporation and its affiliates disclaim any liability for any damages caused by use of this software or hardware in dangerous applications.

Oracle and Java are registered trademarks of Oracle and/or its affiliates. Other names may be trademarks of their respective owners.

Intel and Intel Xeon are trademarks or registered trademarks of Intel Corporation. All SPARC trademarks are used under license and are trademarks or registered trademarks of SPARC International, Inc. AMD, Opteron, the AMD logo, and the AMD Opteron logo are trademarks or registered trademarks of Advanced Micro Devices. UNIX is a registered trademark of The Open Group.

This software or hardware and documentation may provide access to or information on content, products, and services from third parties. Oracle Corporation and its affiliates are not responsible for and expressly disclaim all warranties of any kind with respect to third-party content, products, and services. Oracle Corporation and its affiliates will not be responsible for any loss, costs, or damages incurred due to your access to or use of third-party content, products, or services.

---

---

# Contents

<b>Preface</b> .....	vii
Documentation Accessibility .....	vii
Conventions .....	vii
<b>1 Introduction and Roadmap</b>	
1.1 Document Scope and Audience.....	1-1
1.2 Guide to this Document .....	1-2
1.3 Related Documentation.....	1-2
1.4 New and Changed Features in This Release.....	1-2
<b>2 Understanding Administration Console Extensions</b>	
2.1 What Is an Administration Console Extension?.....	2-1
2.1.1 How Do the WebLogic Portal Framework and WebLogic Portal Differ? .....	2-2
2.2 Extension Points in the Administration Console .....	2-2
2.2.1 Hierarchy of UI Controls .....	2-2
2.2.2 The Administration Console Desktop .....	2-4
2.2.2.1 Extending the Desktop .....	2-4
2.2.3 The Administration Console Look and Feel.....	2-4
2.2.3.1 Extending the Look and Feel .....	2-5
2.2.4 The Home Book and Page .....	2-5
2.2.4.1 Extending the Home Book .....	2-6
2.2.5 The ContentBook .....	2-7
2.2.5.1 Extending the ContentBook .....	2-8
2.2.6 Summary of the Administration Console UI Controls .....	2-8
2.3 JSP Templates and Tag Libraries .....	2-9
2.3.1 JSP Tag Libraries.....	2-9
2.4 Example: How Struts Portlets Display Content .....	2-12
<b>3 Setting Up a Development Environment</b>	
3.1 Set Up the Classpath (Optional) .....	3-1
3.2 Import Tag Libraries Into IDEs (Optional).....	3-1
3.3 Create a Directory Tree for the Extension .....	3-2
3.4 Configure Preferences to See UI Control Labels .....	3-3

## 4 Creating a Message Bundle

## 5 Rebranding the Administration Console

5.1	Files Used to Create a Look and Feel .....	5-1
5.2	Overview of the Process.....	5-1
5.3	Expand the Look and Feel Template.....	5-2
5.4	Modify or Replace Files.....	5-3
5.4.1	Modify the Administration Console Banner .....	5-3
5.4.2	Modify the Login Page.....	5-4
5.4.3	Modify Colors, Fonts, Buttons, and Images.....	5-4
5.4.3.1	Style Sheet Properties.....	5-4
5.4.3.2	Images Used In Conjunction with Style Sheets.....	5-6
5.5	Use a Message Bundle for Your Look and Feel.....	5-7
5.6	Create a NetUI Extension File .....	5-8
5.7	Archive and Deploy the Extension.....	5-9

## 6 Adding Portlets and Navigation Controls

6.1	Define a Portlet.....	6-2
6.1.1	Define a JSP Portlet .....	6-2
6.1.2	Define a Struts Portlet .....	6-3
6.1.3	Define a Page Flow Portlet .....	6-4
6.1.4	Displaying a Title Bar for a Portlet.....	6-5
6.1.4.1	Localizing a Portlet Title.....	6-6
6.1.4.1.1	Create a Backing Class for Localizing Portlet Titles.....	6-6
6.2	Define UI Controls (Optional).....	6-8
6.2.1	Create a Tab That Does Not Contain a Subtab.....	6-8
6.2.2	Create a Tab That Contains Subtabs .....	6-9
6.2.3	Create a Subtab .....	6-11
6.2.4	Create a Control Without Tabs or Subtabs .....	6-12
6.3	Specify a Location for Displaying Portlets or UI Controls.....	6-12
6.3.1	Add a Portlet to the Desktop.....	6-12
6.3.2	Add a Tab or Subtab to ContentBook .....	6-13
6.3.3	Example: Specifying Locations for Portlets and UI Controls.....	6-13
6.4	Add Nodes to the NavTreePortlet (Optional) .....	6-14
6.4.1	Append a Single Node to the Root of the Existing Tree .....	6-15
6.4.2	Append or Insert Nodes or Node Trees .....	6-16
6.4.2.1	Create a NavTreeBacking Class.....	6-16
6.4.2.2	Invoke the NavTreeBacking Class .....	6-18
6.4.2.3	Example: How a NavTreeExtensionBacking Class Adds a Node Tree to the NavTreePortlet.....	6-19
6.5	Navigating to a Custom Security Provider Page .....	6-20

## 7 Using Oracle Templates and JSP Tags

7.1	Create and Use a Message Bundle in Your JSPs.....	7-2
7.2	Overview of Forms and Tables .....	7-3
7.2.1	Data Models for Forms and Tables .....	7-3

7.2.1.1	Data Model for Forms.....	7-3
7.2.1.2	Data Model for Tables.....	7-3
7.2.2	Handles for ActionForms and Row Beans .....	7-4
7.3	Create Struts Artifacts for Tables and Forms.....	7-5
7.3.1	Create Struts Artifacts for a Form JSP: Main Steps.....	7-5
7.3.1.1	Create Struts Action Classes for Handling Form Data .....	7-6
7.3.1.2	Configure Struts ActionForms and Action Mappings.....	7-8
7.3.2	Create Struts Artifacts for a Table JSP .....	7-10
7.4	Create JSPs that Use Oracle Templates and JSP Tags.....	7-12
7.4.1	WebLogic Server JSP Templates.....	7-13
7.4.2	Create a Form JSP .....	7-14
7.4.3	Create a Table JSP for Monitoring.....	7-16
7.4.4	Create a Table Column for Navigating to Other Pages .....	7-18
7.4.5	Add a Handle to Your Row Bean and Action Class.....	7-18
7.4.6	Use the column-link Tag.....	7-19
7.4.7	Use the column-dispatch Tag .....	7-20
7.4.8	Add Buttons and Check Boxes to Tables.....	7-21
7.4.8.1	Add Buttons to a Table .....	7-21
7.4.8.2	Add Check Boxes and Buttons to a Table .....	7-22
7.4.8.3	Example: How Check Boxes and Buttons Process Data .....	7-23
7.4.9	Configure Table Preferences .....	7-25
7.5	Create Other Portal Framework Files and Deploy the Extension.....	7-25

## 8 Adding Online Help for Console Extensions

8.1	Summary of Steps .....	8-1
8.2	Create the Helpset.....	8-1
8.2.1	Helpset Files .....	8-2
8.3	Merging Helpsets.....	8-2
8.3.1	Directory Structure for Merging Extension Help .....	8-3
8.4	Localizing Helpsets.....	8-3
8.5	How Helpsets Are Merged .....	8-4
8.6	Provide Support for Context-Sensitive Help .....	8-5
8.6.1	Provide Help IDs .....	8-5
8.6.1.1	helpid.....	8-5
8.6.1.2	helpurlpattern .....	8-6
8.6.2	Map Help IDs to Help Files.....	8-6
8.7	Rebranding Help.....	8-6
8.8	Deploying Help .....	8-7

## 9 Archiving and Deploying Console Extensions

9.1	Archive and Deploy a Console Extension.....	9-1
9.1.1	Error Output During Deployment .....	9-1



---

---

# Preface

This preface describes the document accessibility features and conventions used in this guide—*Oracle Fusion Middleware Extending the Administration Console for Oracle WebLogic Server*.

## Documentation Accessibility

For information about Oracle's commitment to accessibility, visit the Oracle Accessibility Program website at <http://www.oracle.com/pls/topic/lookup?ctx=acc&id=docacc>.

### Access to Oracle Support

Oracle customers have access to electronic support through My Oracle Support. For information, visit <http://www.oracle.com/pls/topic/lookup?ctx=acc&id=info> or visit <http://www.oracle.com/pls/topic/lookup?ctx=acc&id=trs> if you are hearing impaired.

## Conventions

The following text conventions are used in this document:

Convention	Meaning
<b>boldface</b>	Boldface type indicates graphical user interface elements associated with an action, or terms defined in text or the glossary.
<i>italic</i>	Italic type indicates book titles, emphasis, or placeholder variables for which you supply particular values.
monospace	Monospace type indicates commands within a paragraph, URLs, code in examples, text that appears on the screen, or text that you enter.





---

---

# Introduction and Roadmap

Administration Console extensions enable you to add content to the WebLogic Server Administration Console, replace content, and change the logos, styles and colors without modifying the files that are installed with WebLogic Server. For example, you can add content that provides custom monitoring and management facilities for your applications.

The Administration Console is a Java EE Web application that uses the WebLogic Portal framework, Apache Beehive, Apache Struts, Java Server Pages (JSP), and other standard technologies to render its user interface (UI) and content. It also uses the WebLogic Portal framework to enable extensions.

---

---

**Note:** The Monitoring Dashboard is implemented differently than the rest of the Administration Console, and you do not extend it in the same ways. Rather, you can create new views and charts, as described in "Using the Monitoring Dashboard" in *Configuring and Using the Diagnostics Framework for Oracle WebLogic Server*. However, some changes made to the styles of the Administration Console, as described in [Chapter 5, "Rebranding the Administration Console,"](#) also apply to the Monitoring Dashboard.

---

---

The following sections describe the contents and organization of this guide—Oracle Fusion Middleware Extending the Administration Console for Oracle WebLogic Server.

- [Section 1.1, "Document Scope and Audience"](#)
- [Section 1.2, "Guide to this Document"](#)
- [Section 1.3, "Related Documentation"](#)
- [Section 1.4, "New and Changed Features in This Release"](#)

## 1.1 Document Scope and Audience

This document is a resource for software vendors who embed or rebrand WebLogic Server in their products, software vendors who develop security providers or other resources that extend the functionality of WebLogic Server, and Java EE application developers who want to provide custom monitoring and configuration features for their applications.

It is assumed that the reader is already familiar with using Java, JavaServer Pages, and Apache Struts or Apache Beehive to develop Java EE Web applications. This document emphasizes a hands-on approach to developing a limited but useful Administration

Console extension. For information on applying Administration Console extensions to a broader set of management problems, refer to documents listed in [Section 1.3, "Related Documentation."](#)

## 1.2 Guide to this Document

- This chapter, [Chapter 1, "Introduction and Roadmap,"](#) introduces the organization of this guide.
- [Chapter 2, "Understanding Administration Console Extensions,"](#) introduces the building blocks for creating Administration Console extensions.
- [Chapter 3, "Setting Up a Development Environment,"](#) describes how to set up your environment for developing Administration Console extensions.
- [Chapter 4, "Creating a Message Bundle,"](#) describes how to encapsulate the text that your extension displays into properties files that can be localized.
- [Chapter 5, "Rebranding the Administration Console,"](#) describes how to create a WebLogic Portal Look and Feel and deploy it as an Administration Console extension.
- [Chapter 6, "Adding Portlets and Navigation Controls,"](#) describes how to add portlets that contain simple, static content to the Administration Console.
- [Chapter 7, "Using Oracle Templates and JSP Tags,"](#) describes how to create an extension that uses the Administration Console's JSP templates, styles, and JSP tag library.
- [Chapter 8, "Adding Online Help for Console Extensions,"](#) tells how to create help for a console extension and merge that help into the main Administration Console help system.
- [Chapter 9, "Archiving and Deploying Console Extensions,"](#) describes how to deploy your extension.

## 1.3 Related Documentation

Because the Administration Console uses the WebLogic Portal framework to render its user interface, the process of extending the Administration Console is similar to creating or editing an existing WebLogic Portal application. For information on the WebLogic Portal framework, see:

- [Section 2.1.1, "How Do the WebLogic Portal Framework and WebLogic Portal Differ?"](#)
- "User Interface Development with Look & Feel Features" in *Portal Development Guide for Oracle WebLogic Portal*.

For information on JavaServer Pages, see *JavaServer Pages Technology* at <http://www.oracle.com/technetwork/java/javaee/jsp/index.html>.

For information on Apache Struts, see *The Apache Struts Web Application Framework* at <http://struts.apache.org/>.

For information on Apache Beehive, see <http://beehive.apache.org/>.

## 1.4 New and Changed Features in This Release

For a comprehensive listing of the new WebLogic Server features introduced in this release, see *What's New in Oracle WebLogic Server*.

---

---

# Understanding Administration Console Extensions

This chapter describes the WebLogic Server Administration Console extensions.

This chapter includes the following sections:

- [Section 2.1, "What Is an Administration Console Extension?"](#)
- [Section 2.2, "Extension Points in the Administration Console"](#)
- [Section 2.3, "JSP Templates and Tag Libraries"](#)
- [Section 2.4, "Example: How Struts Portlets Display Content"](#)

## 2.1 What Is an Administration Console Extension?

An Administration Console extension is a WAR file that contains the resources for a section of a WebLogic Portal Web application. When you deploy the extension, the Administration Console creates an in-memory union of the files and directories in its WAR file with the files and directories in the extension WAR file. Once the extension has been deployed, it is a full member of the Administration Console: it is secured by the WebLogic Server security realm, it can navigate to other sections of the Administration Console, and if the extension modifies WebLogic Server resources, it participates in the change control process.

The simplest extension adds content to the Administration Console's home page (desktop). The WAR file for such an extension contains:

- An Administration Console extension descriptor file, called `netuix-extension.xml`, that describes the location in the UI in which you want your extension to display.
- An XML file that defines a WebLogic Portal portlet, which is a container for JSPs and other types of content.
- A JSP file that contains the content you want to display.

The WAR file for more complex extensions can contain any of the following additional resources:

- If the extension displays content in tabs within the Administration Console UI, the WAR contains XML files that describe other types of WebLogic Portal UI controls, such as tabs and subtabs (see [Section 2.2, "Extension Points in the Administration Console"](#)).

- If the extension uses Apache Struts to encapsulate business logic and navigation logic, the WAR file contains configuration files and Java classes for Apache Struts applications.
- If the extension uses Apache Beehive to encapsulate business logic and navigation logic, the WAR file contains configuration files and Java classes for Apache Beehive applications.
- Java classes, image files, or other types of resources that can be used in Java EE Web applications.

---

**Note:** The Administration Console does not support WSRP portlets or portlets based on JSR 168.

---

### 2.1.1 How Do the WebLogic Portal Framework and WebLogic Portal Differ?

The WebLogic Portal framework provides basic support for rendering the UI. The full WebLogic Portal product provides the framework and additional features such as personalization, interaction management, content management, and the ability for end users to customize their portal desktops.

If you have WebLogic Server, then you can use the WebLogic Portal framework when creating Administration Console extensions. If you want your own Web applications to provide a portal interface, you can purchase the WebLogic Portal product.

## 2.2 Extension Points in the Administration Console

An extension point is a location in the Administration Console UI at which you can add or replace content. The UI for the Administration Console is rendered by groups of specialized WebLogic Portal components called UI controls. Each group of controls is responsible for rendering a specific part of the UI. For example, one group renders the two-column layout that you see after you log in to the Administration Console. Other groups render individual tabs in the tabbed interface.

The Administration Console attaches unique labels to many of its UI controls, and each labeled control is an extension point. You can also use these labels with WebLogic Server JSP tags to forward requests to specific UI controls. If a UI control is not identified by a label, you cannot extend it or forward to it. You must either interact with its labeled ancestor control or a labeled child control.

### 2.2.1 Hierarchy of UI Controls

UI controls for an application are defined in an XML file called a portal book file (.book file). The schema for this XML file specifies a hierarchy of UI controls, but some UI controls can be used at multiple levels in the hierarchy. The following list describes the types of UI controls that you will encounter most frequently while developing extensions (see [Figure 2-1](#)):

- Desktop  
The top level of the UI control hierarchy. It contains the Look and Feel for the Administration Console and the top-level book control.
- Look and Feel  
A collection of images, cascading style sheets, XML files, and other file types that control the appearance of a portal application.
- Book

Aggregates a set of pages or other books. It can contain an optional menu control that provides navigation among its pages and books. Many books in the Administration Console use this menu control to render tabs, such as the domain's Configuration: General tab.

- Page

Contains a layout, portlets, or books.

- Layout

Defines a grid in the UI. Each column in the grid is called a placeholder, and each placeholder can host zero or more portlets or books.

Most pages in the Administration Console use a single column layout, but one of the top pages uses a two-column layout to create the left column that contains the Change Center, Domain Structure, and other portlets, and the right column that contains the tabbed interface.

- Portlet

Defines static and dynamic content to display. You can add portlets to the Administration Console that contain JSP files or that forward to Struts Actions or Beehive Page Flows.

For information about the schema for UI controls, see *Portal Support Schema Reference*.

---

**Note:** Figure 2–1 omits some intermediate controls in the hierarchy for the sake of brevity. For example, a book control does not directly contain a page control. Instead, a book contains a control named content, and the content control contains the page control.

---

**Figure 2–1** Subset of the UI Control Hierarchy

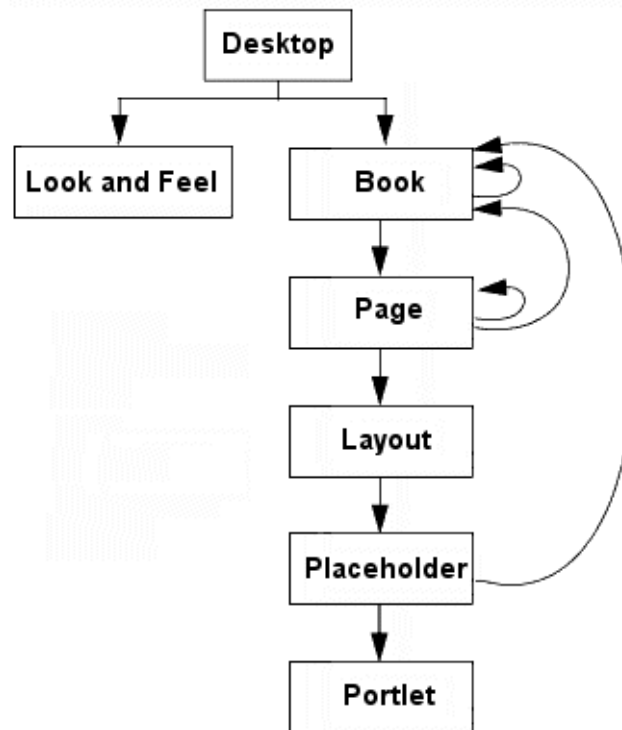

The following sections describe the extension points in the Administration Console:

- [Section 2.2.2, "The Administration Console Desktop"](#)
- [Section 2.2.4, "The Home Book and Page"](#)
- [Section 2.2.5, "The ContentBook"](#)
- [Section 2.2.6, "Summary of the Administration Console UI Controls"](#)

## 2.2.2 The Administration Console Desktop

Every WebLogic Portal Web application must have at least one desktop control, and the Administration Console supports *only* one. Its label is `defaultDesktopLabel` (see [Figure 2-2](#)).

**Figure 2-2 The Desktop**

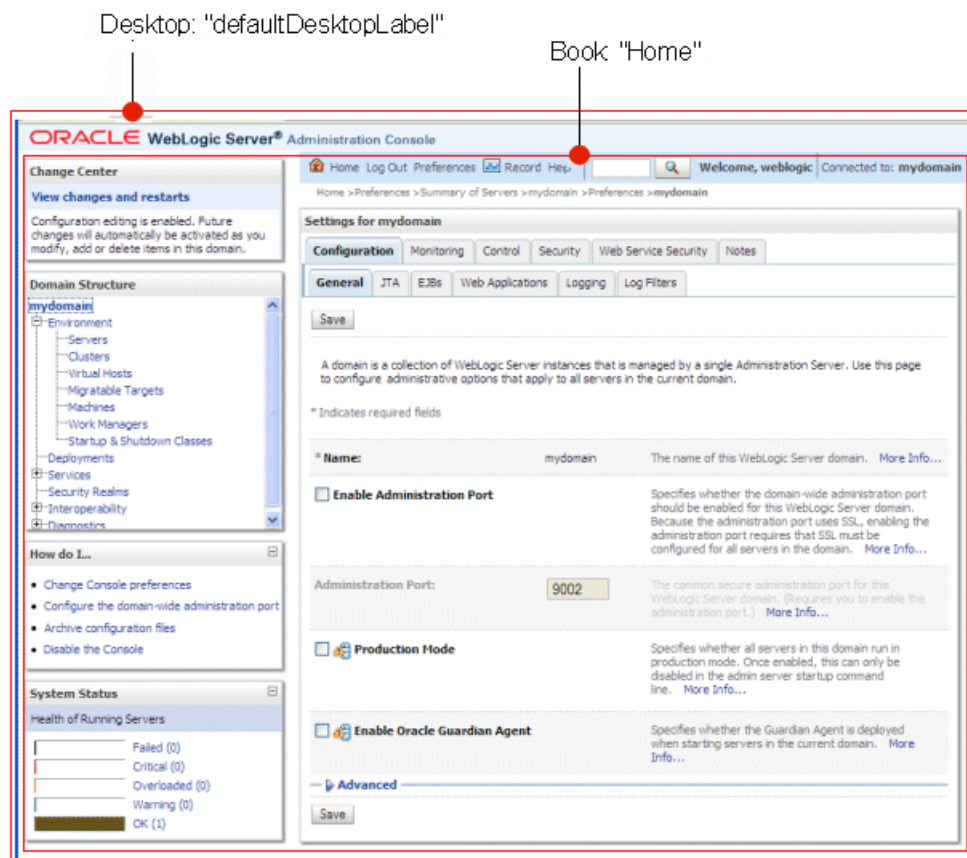

### 2.2.2.1 Extending the Desktop

The only type of extension that is supported at this level of the Administration Console is a Look and Feel extension, which replaces Oracle's logos, colors, and fonts with yours. See [Chapter 5, "Rebranding the Administration Console."](#)

You cannot replace the Home book or add other controls to the desktop.

## 2.2.3 The Administration Console Look and Feel

The Look and Feel for the Administration Console defines the fonts and colors, Oracle logos, the layout of portal components, and the navigation menus.

---

---

**Note:** Because the Administration Console uses only the WebLogic Portal Framework, it supports only a single Look and Feel. Portal applications that use the entire set of features available with the Oracle WebLogic Portal product can support multiple Look and Feels that are personalized based on user or group ID.

---

---

### 2.2.3.1 Extending the Look and Feel

Creating a simple Look and Feel extension that contains your company's logos, fonts, and color scheme requires you to replace the logos and some cascading style sheet (CSS) definitions in a sample Look and Feel included in WebLogic Server. Making complex changes to the WebLogic Server Look and Feel, such as changing the layout of portal components and navigation menus, requires a more advanced knowledge of WebLogic Portal Look and Feels. If you have Oracle Workshop for WebLogic Platform 9.2 or later, you can use its Look and Feel editor to make these complex changes. For more information about Look and Feels, see "User Interface Development with Look & Feel Features" in *Portal Development Guide for Oracle WebLogic Portal*.

## 2.2.4 The Home Book and Page

The top-level book in the Administration Console is identified by the label `Home`. It contains a single page (labeled `page`) within which resides all of the Administration Console content (see [Figure 2-3](#)).



**Figure 2-3 The Home Book and Page**

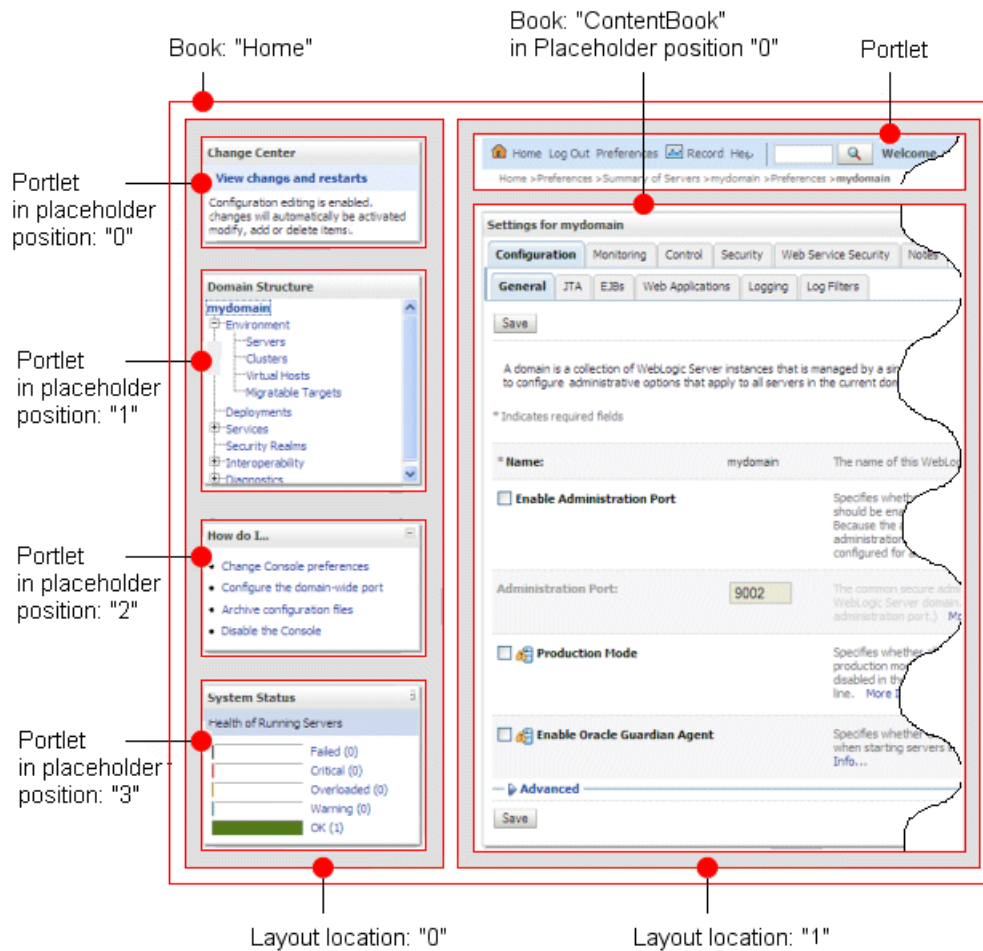

The page uses a two-column layout. The left column (layout location 0) contains portlets that provide essential services when using the Administration Console. The right column (layout location 1) contains:

- Portlets:
  - The topmost portlet displays a welcome message and contains buttons that launch online help and other services.
  - The second portlet displays breadcrumbs, which are a series of hypertext links that keep a history of your navigation in the Administration Console.
  - A third portlet is hidden by default and displays error messages and other status messages.
- A book named `ContentBook`. See [Section 2.2.5, "The ContentBook."](#)

### 2.2.4.1 Extending the Home Book

The simplest extensions within the Home book add portlets to either column of its page. For example, below the System Status portlet, you can add a portlet that monitors your applications.

More complex extensions can append a book to the Home book. Such an extension causes the Home book and the extension book to display as two separate tabs.



## 2.2.5 The ContentBook

The ContentBook is a book that contains over 40 pages (see [Figure 2–4](#)), but it displays only one page at a time. Navigational controls throughout the Administration Console determine which page is displayed.

**Figure 2–4 The ContentBook**

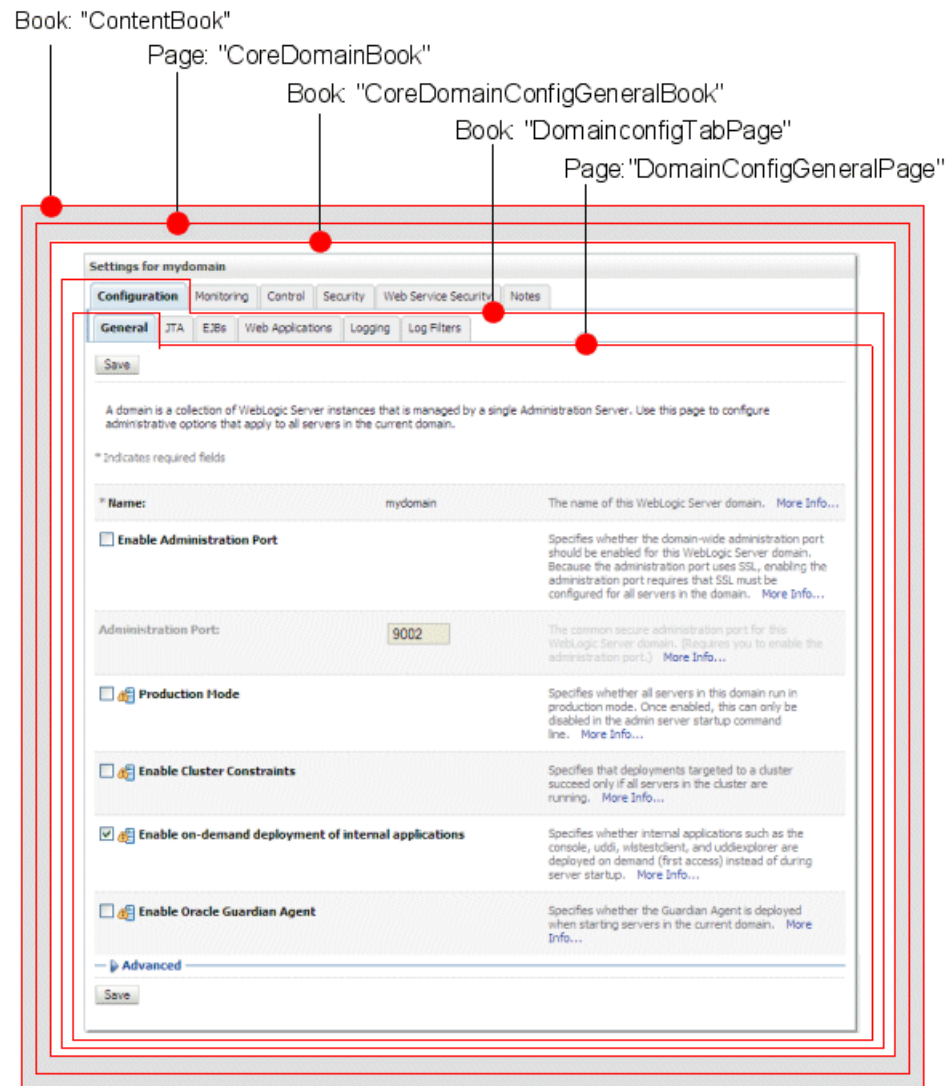

In [Figure 2–4](#), a page named `CoreDomainBook` contains a book named `CoreDomainConfigGeneralBook`. The `CoreDomainConfigGeneralBook` contains six child books and a special UI control named `singleLevelMenu` that renders a tab for each child book (Configuration, Monitoring, Control, Security, WebService Security, and Notes). In turn, each child book (such as `DomainconfigTabPage`) contains several child page controls and the `singleLevelMenu` control. The Look and Feel causes the `singleLevelMenu` control to generate subtabs for the page controls at this level (General, JTA, EJBs, Web Applications, SNMP, Logging, and Log Filters).

Some content-specific books do not display a tabbed interface for their child books. [Figure 2–5](#) shows the `ServerBook`, which does not display a tabbed interface.

**Figure 2-5 ServerTableBook**

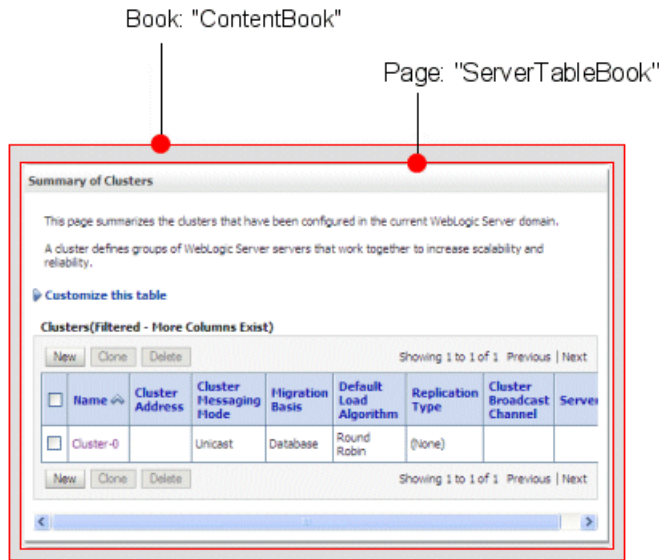

### 2.2.5.1 Extending the ContentBook

The simplest extensions within the ContentBook add a child book to create a tab in a content-specific book or add a child page to create a subtab. See [Section 6.2, "Define UI Controls \(Optional\)."](#)

## 2.2.6 Summary of the Administration Console UI Controls

[Figure 2-6](#) shows the top levels of the Administration Console's labeled UI controls. To see all labeled UI controls, including all of the content-specific books, you can display all the console extension points in the Administration Console, as described in [Section 3.4, "Configure Preferences to See UI Control Labels."](#)

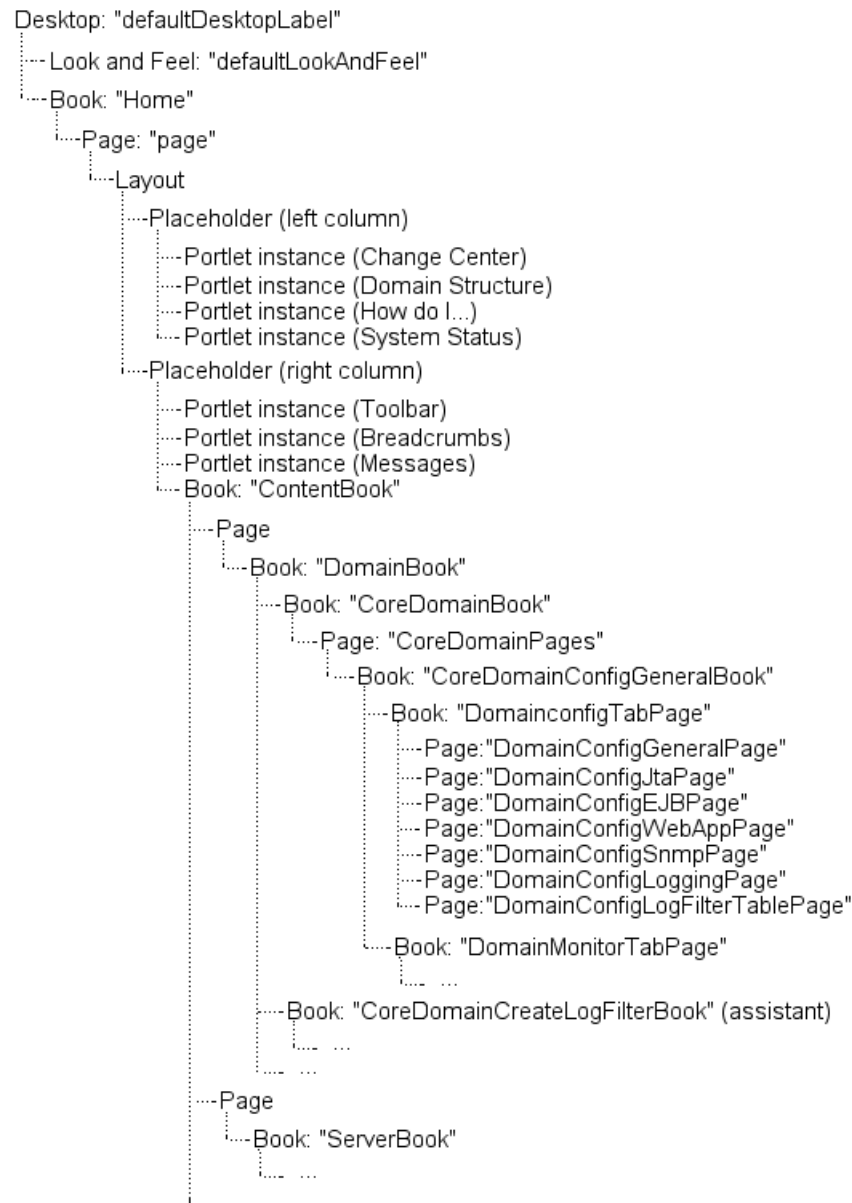
**Figure 2-6 Summary of the UI Control Hierarchy**

## 2.3 JSP Templates and Tag Libraries

Oracle provides JSP templates and tag libraries that you can use to render such UI features as tables, data-entry boxes, and buttons. For information about the JSP templates, see [Section 7.4.1, "WebLogic Server JSP Templates."](#)

### 2.3.1 JSP Tag Libraries

The Administration Console provides its own tag library (`console-html.tld`) that you can use in your Administration Console extensions. It also provides runtime support for a group of standard, third-party tag libraries that the Administration Console itself uses.

To import these third-party JSP tag libraries into your JSPs, you must use pre-defined, absolute URIs. The Administration Console's `web.xml` file maps these URIs to tag

libraries within the WebLogic Server installation. This mapping facility enables Oracle to reorganize its installation directory without requiring you to change your JSPs.

**Table 2–1** lists the tag libraries for which the Administration Console provides runtime support and the URIs for importing them into your JSPs.

If you want development support for these libraries (for example, if you use an integrated development environment that provides code completion for JSP tags), you must configure your development environment to include these tags.

---



---

**Note:** You can create custom tag libraries or use additional tag libraries, but you must include all of the necessary support files for custom tag libraries in your extension WAR file. See *Programming JSP Tag Extensions for Oracle WebLogic Server*.

---



---

**Table 2–1 Included JSP Tag Library Support**

Tag Library and URI	Description
<b>Tag library:</b> console-html.tld <b>URI:</b> /WEB-INF/console-html.tld	WebLogic Server JSP tags for creating HTML forms and tables that match the functionality of the forms and tables in the Administration Console.  Use these tags only to extend the WebLogic Server Administration Console.  The documentation for this tag library is in the <i>Oracle WebLogic Server JSP Tags Reference</i> .
<b>Tag library:</b> render.tld <b>URI:</b> render.tld	Convenience tag for generating a portal framework URL. See <render:pageUrl> Tag in the <i>Portal Framework JSP Tag Javadoc</i> .
<b>Tag library:</b> beehive-netui-tags-template.tld <b>URI:</b> <a href="http://beehive.apache.org/netui/tags-template-1.0">http://beehive.apache.org/netui/tags-template-1.0</a>	Apache Beehive JSP tags for associating JSPs with a JSP template.  You can download the Beehive distribution, which includes the tag libraries and documentation from <a href="http://beehive.apache.org/downloads.html">http://beehive.apache.org/downloads.html</a> .
<b>Tag library:</b> beehive-netui-tags-databinding.tld <b>URI:</b> <a href="http://beehive.apache.org/netui/tags-databinding-1.0">http://beehive.apache.org/netui/tags-databinding-1.0</a>	Apache Beehive JSP tags for binding data.  You can download the Beehive distribution, which includes the tag libraries and documentation from <a href="http://beehive.apache.org/downloads.html">http://beehive.apache.org/downloads.html</a> .
<b>Tag library:</b> beehive-netui-tags-html.tld <b>URI:</b> <a href="http://beehive.apache.org/netui/tags-html-1.0">http://beehive.apache.org/netui/tags-html-1.0</a>	Apache Beehive JSP tags for generating basic HTML tags.  You can download the Beehive distribution, which includes the tag libraries and documentation from <a href="http://beehive.apache.org/downloads.html">http://beehive.apache.org/downloads.html</a> .

**Table 2–1 (Cont.) Included JSP Tag Library Support**

Tag Library and URI	Description
<p><b>Tag library:</b> <code>c.tld</code>  <b>URI:</b> <code>http://java.sun.com/jsp/jstl/core</code></p>	<p>JavaServer Pages Standard Tag Library (JSTL) tags which provide core functionality common to many JSP applications.</p> <p>You can download the JSTL distribution from <a href="http://java.sun.com/products/jsp/jstl/downloads/index.html">http://java.sun.com/products/jsp/jstl/downloads/index.html</a>.</p> <p>The documentation for these tag libraries is in the <i>JSTL Tag Library Reference</i> at <a href="http://download.oracle.com/docs/cd/E17802_01/products/products/jsp/jstl/1.1/docs/tlddocs/index.html">http://download.oracle.com/docs/cd/E17802_01/products/products/jsp/jstl/1.1/docs/tlddocs/index.html</a>.</p>
<p><b>Tag library:</b> <code>fmt.tld</code>  <b>URI:</b> <code>http://java.sun.com/jsp/jstl/fmt</code></p>	<p>JavaServer Pages Standard Tag Library (JSTL) tags which provide core functionality common to many JSP applications.</p> <p>You can download the JSTL distribution from <a href="http://java.sun.com/products/jsp/jstl/downloads/index.html">http://java.sun.com/products/jsp/jstl/downloads/index.html</a>.</p> <p>The documentation for these tag libraries is in the <i>JSTL Tag Library Reference</i> at <a href="http://download.oracle.com/docs/cd/E17802_01/products/products/jsp/jstl/1.1/docs/tlddocs/index.html">http://download.oracle.com/docs/cd/E17802_01/products/products/jsp/jstl/1.1/docs/tlddocs/index.html</a>.</p>
<p><b>Tag library:</b> <code>struts-bean.tld</code>  <b>URI:</b> <code>http://struts.apache.org/tags-bean</code></p>	<p>Apache Struts tags for interacting with the Struts framework.</p> <p>You can download the Struts distribution from <a href="http://struts.apache.org/download.cgi">http://struts.apache.org/download.cgi</a>.</p> <p>The documentation for these tag libraries is available from <a href="http://struts.apache.org/">http://struts.apache.org/</a>.</p>
<p><b>Tag library:</b> <code>struts-html.tld</code>  <b>URI:</b> <code>http://struts.apache.org/tags-html</code></p>	<p>Apache Struts tags for interacting with the Struts framework.</p> <p>You can download the Struts distribution from <a href="http://struts.apache.org/download.cgi">http://struts.apache.org/download.cgi</a>.</p> <p>The documentation for these tag libraries is available from <a href="http://struts.apache.org/">http://struts.apache.org/</a>.</p>
<p><b>Tag library:</b> <code>struts-logic.tld</code>  <b>URI:</b> <code>http://struts.apache.org/tags-logic</code></p>	<p>Apache Struts tags for interacting with the Struts framework.</p> <p>You can download the Struts distribution from <a href="http://struts.apache.org/download.cgi">http://struts.apache.org/download.cgi</a>.</p> <p>The documentation for these tag libraries is available from <a href="http://struts.apache.org/">http://struts.apache.org/</a>.</p>
<p><b>Tag library:</b> <code>struts-tiles.tld</code>  <b>URI:</b> <code>http://struts.apache.org/tags-tiles</code></p>	<p>Apache Struts tags for interacting with the Struts framework.</p> <p>You can download the Struts distribution from <a href="http://struts.apache.org/download.cgi">http://struts.apache.org/download.cgi</a>.</p> <p>The documentation for these tag libraries is available from <a href="http://struts.apache.org/">http://struts.apache.org/</a>.</p>

## 2.4 Example: How Struts Portlets Display Content

The following steps describe how the portal framework uses an extension's source files to find and display a Struts portlet as a tab in ContentBook:

1. The portal framework starts by parsing the extension's `netuix-extension.xml` file.

The `netuix-extension.xml` file in this example specifies that the portal framework should load a `.book` file named `medrecMonitor.book` and display its contents as a child of the `CoreDomainConfigGeneralBook` book:

```
<book-extension>
  <book-location>
    <parent-label-location label="CoreDomainConfigGeneralBook" />
    <book-insertion-point action="append" />
  </book-location>
  <book-content content-uri="/controls/medrecMonitor.book" />
</book-extension>
```

2. The portal framework loads the `medrecMonitor.book` file, which defines a page UI control and specifies that the page contains a portlet:

```
<netuix:page markupName="page" markupType="Page">
  ...
  <netuix:portletInstance markupType="Portlet"
    instanceLabel="medrecMonitor.Tab.Portlet"
    contentUri="/portlets/medrec_monitor_tab.portlet" />
</netuix:page>
```

3. The portal framework loads the portlet file, which names a Struts Action to run:

```
<portal:root>
  <netuix:portlet
    definitionLabel="MyPortlet"
    title="my.portlet.title">
    <netuix:strutsContent module="/medrecMBean"
      action="MedRecMBeanFormAction"
      refreshAction="MedRecMBeanFormAction" />
  </netuix:portlet>
</portal:root>
```

In the `netuix:strutsContent` element, the `module="/medrecMBean"` attribute indicates that the definition for the `MedRecMBeanFormAction` Struts Action is located in the Struts configuration file for the Struts module named `medrecMBean`. The Struts naming convention requires that this configuration file be named `struts-auto-config-medrecMBean.xml`.

4. The portal framework hands control to the Struts controller servlet, which parses the `struts-auto-config-medrecMBean.xml` file and finds the following definition for the `MedRecMBeanFormAction`:

```
<action path="/MedRecMBeanFormAction"
  type="com.bea.medrec.extension.MedRecMBeanFormAction"
  name="medrecMBeanEJBForm"
  scope="request"
  validate="false">
  <forward name="success" contextRelative="true"
    path="/ext_jsp/form_view.jsp" />
</action>
```

- When the Struts controller encounters the `name="medrecMBeanEJBForm"` attribute of the `action` element, it looks in the same Struts configuration file for the definition of a form bean that is named `medrecMBeanEJBForm`.

When it finds the following element in configuration file:

```
<form-bean name="medrecMBeanEJBForm"
  type="org.apache.struts.action.DynaActionForm">
  <form-property name="name"
    type="java.lang.String"/>
  <form-property name="handle"
    type="com.bea.console.handles.Handle"/>
  <form-property name="totalRx"
    type="java.lang.Integer"/>
</form-bean>
```

it initializes a Java bean of type `org.apache.struts.action.DynaActionForm` with properties named `name`, `handle`, and `totalRx`.

- The Struts controller invokes the `com.bea.medrec.extension.MedRecMBeanFormAction` class and passes to this class the `DynaActionForm` bean that it instantiated.
- The `MedRecMBeanFormAction` class gathers data from an MBean in the MedRec application and populates the properties in the `DynaActionForm` bean with data from the MedRec MBean.

The `MedRecMBeanFormAction` class returns the populated `DynaActionForm` bean.

- The Struts controller serializes the `DynaActionForm` bean, sets it in an HTTP request, and then forwards to a JSP.
- The JSP uses JSP tags to display data in the `DynaActionForm` bean.

**Figure 2-7 Overview of Loading a Struts Portlet**

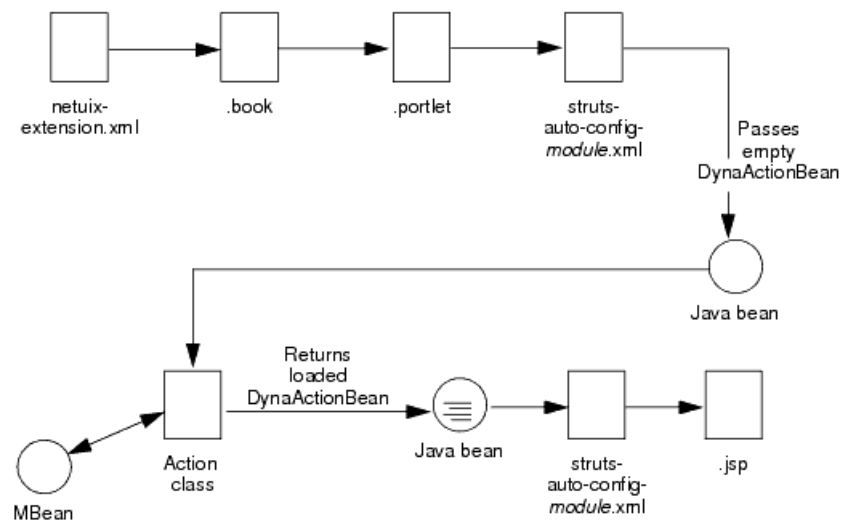





---

## Setting Up a Development Environment

This chapter describes how to set up an environment for developing WebLogic Server Administration Console extensions using JSP tag libraries, schemas, and base Java classes. An Administration Console extension is a collection of XML files, Java classes, JSPs, and other standard Web-related resources. You can use any text editor or Integrated Development Environment (IDE) to develop your extension.

This chapter includes the following sections:

- [Section 3.1, "Set Up the Classpath \(Optional\)"](#)
- [Section 3.2, "Import Tag Libraries Into IDEs \(Optional\)"](#)
- [Section 3.3, "Create a Directory Tree for the Extension"](#)
- [Section 3.4, "Configure Preferences to See UI Control Labels"](#)

### 3.1 Set Up the Classpath (Optional)

If you are creating Apache Struts classes or Beehive Page Flow classes for your extension, you need a set of Apache classes in your classpath. If you are adding nodes to the NavTreePortlet, you need a set of Oracle classes.

To add these classes to your classpath, run the following script:

```
WL_HOME\server\bin\setWLSEnv.cmd
```

or

```
WL_HOME\server\bin\setWLSEnv.sh
```

where *WL\_HOME* is the directory in which you installed WebLogic Server.

Instead of using Oracle's script, you can add to your environment's classpath all of the JAR files in the *WL\_HOME/server/lib/consoleapp/webapp/WEB-INF/lib* directory.

### 3.2 Import Tag Libraries Into IDEs (Optional)

If you are using Oracle's JSP templates to create JSPs in your extension, you must use JSP tags from the JSP Standard Tag Library (JSTL), the Oracle Administration Console Extension Tag Library, and the Apache Beehive Page Flows Tag Library.

WebLogic Server installs a version of these tag libraries, which you can make available to your IDE. Alternatively, you can download your own copy of these standard tag libraries. For more information, see [Section 2.3, "JSP Templates and Tag Libraries."](#)

### 3.3 Create a Directory Tree for the Extension

An Administration Console extension is a portion of a Web application and its resources must be organized into a directory structure that satisfies the requirements for standard Java EE Web applications. In addition, the WebLogic Portal framework, Apache Struts, and Apache Beehive require configuration files to be in specific locations.

To start working on your Administration Console extension, create a directory tree that matches the skeletal structure in [Table 3-1](#).

**Table 3-1** Directory Tree for an Administration Console Extension

Directory	Description
<i>root-dir</i>	<p>The root directory of your extension. Oracle recommends that you do not create files in this directory.</p> <p>The name of the directory has no programmatic significance. Choose a name that is meaningful to you.</p> <p>When specifying URIs in your extension, the "/" (forward slash) character by itself represents this root directory.</p>
<i>root-dir</i> /WEB-INF	<p>This directory must contain a file named <code>netuix-extension.xml</code>. This XML file functions as your extension's deployment descriptor.</p> <p>If you use Apache Struts, you must locate your Struts configuration file in this directory.</p>
<i>root-dir</i> /WEB-INF/classes	<p>If your extension uses a message bundle, your properties files must be in this directory.</p> <p>If your extension uses custom classes, your package structure must start in this directory. For example, if you packaged your class files in a package named <code>com.mycompany.extension</code>, then create the following directory structure in the <code>classes</code> directory: <code>com/mycompany/extension</code>. Then save your compiled class files in this <code>extension</code> directory.</p>
(optional) <i>root-dir</i> /WEB-INF/src	<p>If your extension uses custom classes, Oracle recommends that you save your pre-compiled Java source files in a package structure that starts in this directory.</p> <p>When you archive your extension, you do not include this <code>src</code> directory.</p>
(recommended) <i>root-dir</i> /ext_jsp	<p>Oracle recommends that you save all of your extension's JSP files below a directory named <code>ext_jsp</code>.</p> <p>Creating a separate directory for your JSPs shields content developers from needing to learn about other support files such as the Portal framework XML files.</p> <p>If your extension contains many JSPs, consider creating subdirectories below <code>ext_jsp</code>.</p> <p>If you follow this recommendation, URIs for your JSPs will start with <code>/ext_jsp</code>. For example, <code>/ext_jsp/myContent.jsp</code></p> <p>The directory named <i>root-dir</i>/jsp is reserved. The root directory of your extension must not contain a directory named <code>jsp</code>.</p>

**Table 3–1 (Cont.) Directory Tree for an Administration Console Extension**

Directory	Description
(recommended) <i>root-dir/controls</i>	<p>Oracle recommends that you save all of your extension's portal book files (.book) below a directory named <i>controls</i>.</p> <p>If your extension contains many books or pages, consider creating subdirectories below <i>controls</i>.</p> <p>If you follow this recommendation, URIs for your books or pages will start with <i>/controls</i>. For example, <i>/controls/myBook.book</i>.</p>
(recommended) <i>root-dir/portlets</i>	<p>Oracle recommends that you save all of your extension's portlet files (.portlet) below a directory named <i>portlets</i>.</p> <p>If your extension contains many portlets, consider creating subdirectories below <i>portlets</i>.</p> <p>If you follow this recommendation, URIs for your portlets will start with <i>/portlets</i>. For example, <i>/portlets/myContent.portlet</i>.</p>

If you are extending the Administration Console's Look and Feel, your root directory will contain additional subdirectories. See [Chapter 5, "Rebranding the Administration Console."](#)

### 3.4 Configure Preferences to See UI Control Labels

WebLogic Server provides a configuration option for displaying the labels of the Administration Console's extension points. You use these labels to specify where you want your extension to display. To display these labels:

1. In the Administration Console toolbar, click **Preferences**.
2. Select the **Extensions** tab.
3. Select **Show Definition Labels**.
4. Click **Save**.

A field is displayed over each labeled control on the page. The field displays the value of the control's `definitionLabel`, prefixed by `Book:` or `Label:` to indicate whether it is a book or a label. See [Figure 3–1](#).

**Figure 3–1 Control Labels in the Administration Console User Interface**

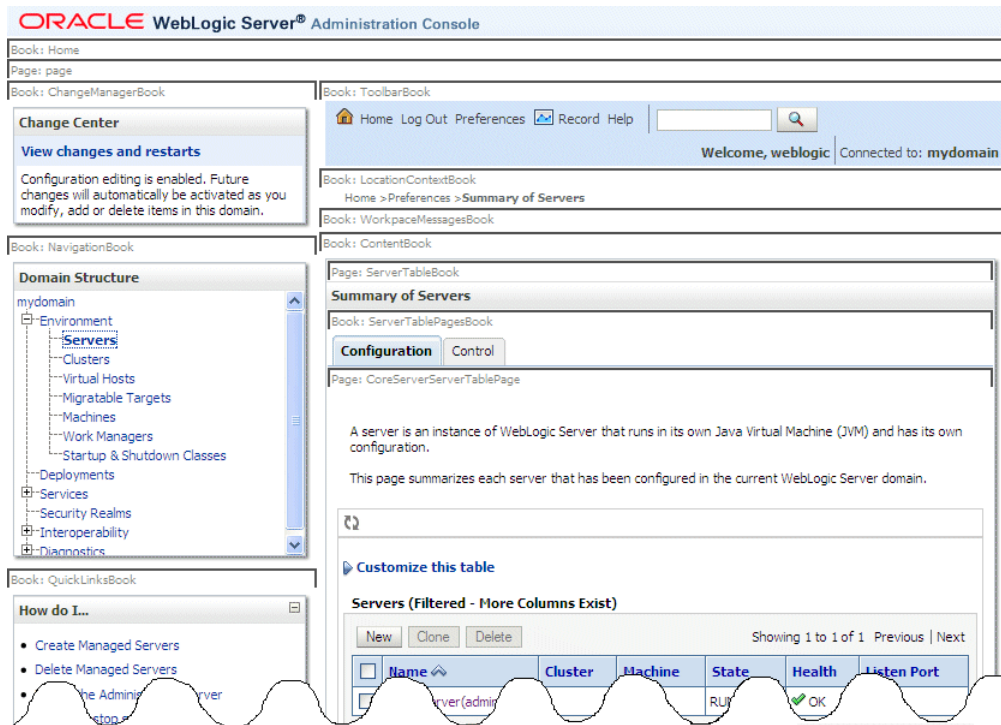

---

---

## Creating a Message Bundle

This chapter describes how to define all of the text strings that your WebLogic Server Administration Console extension displays in a message bundle.

A message bundle is a collection of text files (properties files) that contain key-value pairs (properties). You create one properties file for each language or locale that you want to support. If you name the properties file per a set of file-naming conventions, the Administration Console displays strings from the properties file whose locale matches the Web browser's locale setting.

To create a message bundle:

1. Create a text file that contains name-value pairs for each string you want to display. Use the equal sign (=) as the delimiter between the name and value, and place each property on its own line.

For example:

```
myextension.myTab.introduction=This page provides monitoring data for
my application.
myextension.myTab.TotalServletHits.label=Total hits for my servlet.
```

2. Save the file as `root-dir/WEB-INF/classes/bundle.properties` where
  - `root-dir` is the root directory of your extension
  - `bundle` is a unique value (do not use `global`, which is the name of a WebLogic Server bundle). Consider using your company name as the value for `bundle`.

The `bundle.properties` file is the default file that the Administration Console uses if the Web browser or the JVM have not specified a locale. It is a required file.

3. Save each localized version of the properties file as `root-dir/WEB-INF/classes/bundle_locale.properties`.

where `locale` is a locale code supported by `java.util.Locale`. See `Locale` in the *Java SE API Specification*, at <http://download.oracle.com/javase/1.5.0/docs/api/java/util/Locale.html>.

For example, `mycompany_ja.properties`.

For information about using message bundles, see [Section 5.5, "Use a Message Bundle for Your Look and Feel"](#) and [Section 7.1, "Create and Use a Message Bundle in Your JSPs"](#).



---

---

## Rebranding the Administration Console

This chapter describes how to create a WebLogic Portal Look and Feel and deploy it as a WebLogic Server Administration Console extension. A Look and Feel extension enables you to replace some or all of Oracle's logos, colors, and styles in the Administration Console.

This chapter includes the following sections:

- [Section 5.1, "Files Used to Create a Look and Feel"](#)
- [Section 5.2, "Overview of the Process"](#)
- [Section 5.3, "Expand the Look and Feel Template"](#)
- [Section 5.4, "Modify or Replace Files"](#)
- [Section 5.5, "Use a Message Bundle for Your Look and Feel"](#)
- [Section 5.6, "Create a NetUI Extension File"](#)
- [Section 5.7, "Archive and Deploy the Extension"](#)

### 5.1 Files Used to Create a Look and Feel

The following types of files are used to create the look and feel of a console extension:

- Cascading stylesheets (CSS). Most of the changes (and the easiest changes) are done by changing CSS.
- Images. These may be referenced from CSS files or by the HTML generated by skeleton JSPs or content JSPs. If you change an image but keep it the same size and use the same name, you do not have to change the CSS or JSPs that reference it.
- Skeleton Java Server (JSP) files.
- JavaScript files. Client side behaviors come from JavaScript files. Oracle recommends that you do not change these files.

All of the Look and Feel files (CSS, skeleton, JavaScript and images) are subject to change with each release. Therefore, when you upgrade to a new release of WebLogic server, you may have to update your custom Look and Feel.

### 5.2 Overview of the Process

[Figure 5-1](#) illustrates the process. The steps in the process and the results of each are described in [Table 5-1](#). Subsequent sections detail each step in the process.

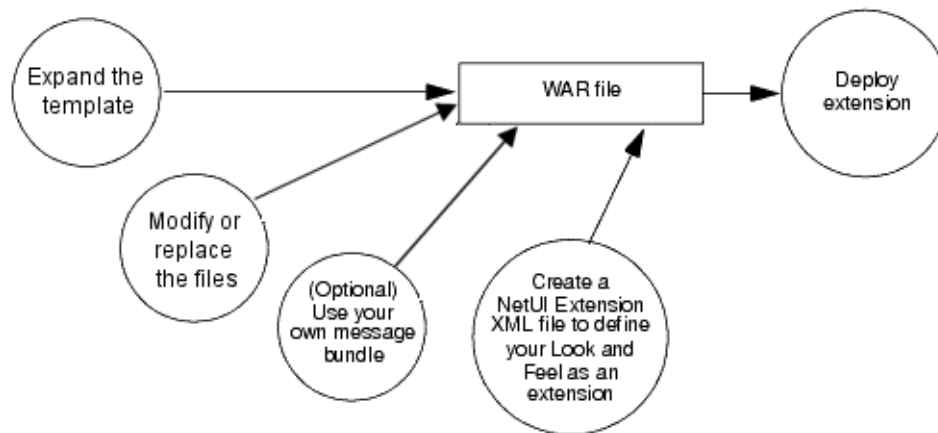
**Figure 5–1 Administration Console Extension Development Overview****Table 5–1 Rebrand the Administration Console: Tasks and Results**

Step	Description	Result
1. <a href="#">Expand the Look and Feel Template</a>	WebLogic Server includes a Look and Feel template that you can use as a starting point. Expand the template to access the files.	A set of Look and Feel files you can modify.
2. <a href="#">Modify or Replace Files</a>	Replace images and styles with your own to create a custom Look and Feel for the console.	A Look and Feel that contains your logos and styles.
3. (Optional) <a href="#">Use a Message Bundle for Your Look and Feel</a>	If you want to change the text messages displayed in the banner, login, and login error pages, create your own message bundle and modify the pages to use messages from your bundle.	Localized properties files that contain your messages.
4. <a href="#">Create a NetUI Extension File</a>	The NetUI Extension file describes the locations of files and directories in your Look and Feel.	<code>netuix-extension.xml</code>
5. <a href="#">Archive and Deploy the Extension</a>	Archive the Look and Feel extension in a WAR file and copy it to your domain's <code>console-ext</code> directory.  See <a href="#">Chapter 9, "Archiving and Deploying Console Extensions."</a>	When the Administration Console starts in your domain, it uses the Look and Feel extension that is in the domain's <code>console-ext</code> directory instead of the Look and Feel that Oracle packages and installs.

## 5.3 Expand the Look and Feel Template

Your WebLogic Server installation includes a Look and Feel template that you can use as a starting point. Expand the template, and replace the images and styles with your own. There are two files:

- `build-new-laf.xml`

This file is an ant script that creates the initial set of Look and Feel files for an extension. This script expands the Look and Feel files from `laftemplate.zip` (see below) and renames directories to correspond to the name of your extension.

- `laftemplate.zip`



This template contains the initial set of Look and Feel files that `build-new-laf.xml` expands.

To expand the template:

1. If you do not already have Apache Ant installed (or available in an IDE), install and configure it. See The Apache Ant Project at <http://ant.apache.org/>.
2. From a command prompt, change to the following directory:

```
WL_HOME/server/lib/console-ext/templates
```

where `WL_HOME` is the directory in which you installed WebLogic Server.

3. Run Ant on `build-new-laf.xml` using the following syntax:

```
ant -f build-new-laf.xml -Dname=ext-name -Ddir=root-dir
```

where `ext-name` is the name of your extension and `root-dir` is your console extension development directory, for example:

```
ant -f build-new-laf.xml -Dname=myLAF -Ddir=c:\src\laf-ext
```

The files from `laf-template.zip` are extracted into `root-dir`.

## 5.4 Modify or Replace Files

Once the template is expanded, you can modify or replace the files to create your own Look and Feel. See the following:

- [Modify the Administration Console Banner](#)
- [Modify the Login Page](#)
- [Modify Colors, Fonts, Buttons, and Images](#)

Making more complex changes to the WebLogic Server Look and Feel, such as changing the layout of portal components and navigation menus, requires a more advanced knowledge of WebLogic Portal Look and Feels. For more information, see "User Interface Development with Look & Feel Features" in *Portal Development Guide for Oracle WebLogic Portal*.

### 5.4.1 Modify the Administration Console Banner

To overwrite the sample Look and Feel's image files with your image files, do the following

1. To replace the logo in the Administration Console banner, save your own logo file as `root-dir/framework/skins/ext-name/images/Branding_WeblogicConsole.gif`.

To prevent the need to resize the banner frame, do not change the size of the image.

2. To change the background color of the banner, replace the following image file with one of the same size but that contains a different color:

```
root-dir/framework/skins/ext-name/images/titlebar_bg.png
```

3. To replace the ALT text for the logo, change the value of the `login.wlsident` key in the `global.properties` file (and any `bundle_locale.properties` files). See [Section 5.5, "Use a Message Bundle for Your Look and Feel."](#)

To make more complex modifications, you can change the JSP and styles that render the banner. The `root-dir/framework/skeletons/ext-name/header.jsp` file determines the contents of the Administration Console banner. Within `header.jsp`, the style `console-header-logo` specifies the name and location of an image file that is used as the banner background. The style `console-title` specifies the name and location of the logo file. Both of these styles are defined in `root-dir/framework/skins/ext-name/css/console.css`.

---

**Note:** You must precompile JSPs before deploying the extension.

---

## 5.4.2 Modify the Login Page

The login page asks users to enter a user ID and password. [Table 5–2](#) summarizes the files that determine the appearance of the login page.

**Table 5–2 Files for the Login and Login Error Page Appearance**

File Name and Path (Under <code>root-dir/</code> )	Description
<code>css/login.css</code>	Defines fonts and spacing for the login page.
<code>framework/skins/ext-name/images/Branding_Login_WeblogicConsole.gif</code> <code>framework/skins/ext-name/images/Login_GC_LoginPage_Bg.gif</code> <code>framework/skins/ext-name/images/Loginarea_Background.png</code>	Images for the login page. See <a href="#">Table 5–4</a> for more information about <code>Login_GC_LoginPage_Bg.gif</code> and <code>Loginarea_Background.png</code> .
<code>login/LoginForm.jsp</code>	Render the login page.  If you want to change the text that these pages display, modify the <code>&lt;fmt:message/&gt;</code> JSP tags to point to messages in your own message bundle. See <a href="#">Section 5.5, "Use a Message Bundle for Your Look and Feel."</a>

## 5.4.3 Modify Colors, Fonts, Buttons, and Images

The Administration Console uses several cascading style sheets (CSS) to specify its fonts and colors, as well as other properties such as spacing. To change these styles, open the style sheet and change the style's definition.

### 5.4.3.1 Style Sheet Properties

[Table 5–3](#) summarizes the Look and Feel styles defined in the style sheets. The styles themselves are not described in the table, because the style names in the style sheets are adequately descriptive, for example, `background-color`.

**Table 5–3 CSS Style Sheets Used for Look and Feel Extensions**

File Name and Path (Under <i>root-dir/</i> )	Styles
<code>css/changemgt.css</code>	Styles for the Change Center ("Lock and Edit") panel.
<code>css/content.css</code>	The following styles: <ul style="list-style-type: none"> <li>■ General console layout, such as margins.</li> <li>■ The toolbar area.</li> <li>■ Breadcrumbs.</li> <li>■ Messages.</li> <li>■ Data tables.</li> </ul>
<code>css/forms.css</code>	Styles for defining forms, such as configuration and monitoring page content areas.
<code>css/jndinavtree.css</code>	Styles to define the navigation tree in the JNDI browser.
<code>css/login.css</code>	Styles for the login page.
<code>css/navtree.css</code>	Styles to define the navigation tree in the Domain Structure panel.
<code>css/quicklinks.css</code>	Styles for the How Do I... panel.
<code>css/systemstatus.css</code>	Styles for the System Status panel.
<code>framework/skeletons/ext-name/css/layout.css</code>	Default styles for the grid on which the other user-interface items are arranged.
<code>framework/skins/ext-name/css/console.css</code>	The following styles: <ul style="list-style-type: none"> <li>■ Console header and footer styles, including logo image file name and location, background color, size, etc.</li> <li>■ Structural elements, such as margins and widths.</li> <li>■ Background colors for content areas.</li> <li>■ Breadcrumb styles.</li> <li>■ Styles to enhance screen reader support.</li> </ul>
<code>framework/skins/ext-name/css/general.css</code>	The following styles: <ul style="list-style-type: none"> <li>■ The background color for the console, including the Domain Structure, How do I..., and System Status panes on the left side, as well as the areas behind content areas.</li> <li>■ Typography throughout the console, including font family, font weight, font size, text color, text decoration, link styles, etc.</li> </ul>
<code>framework/skins/ext-name/css/menu.css.css</code>	Styles to define menu margins, padding, backgrounds, colors, etc.
<code>framework/skins/ext-name/css/window.css</code>	The following styles: <ul style="list-style-type: none"> <li>■ Titlebar colors, borders, padding, alignment, image rollover behavior, etc.</li> <li>■ Windows styles, such as border style and color, spacing, background image file name and location, etc.</li> <li>■ Window content overflow handling.</li> </ul>

### 5.4.3.2 Images Used In Conjunction with Style Sheets

Several images are used in conjunction with the style sheets to create effects such as rounded and shaded corners on tabs and buttons. These are summarized in [Table 5–4](#) and [Table 5–5](#). To change any of these effects, you can substitute your image for the default image, using the same file name; or you can reference a different image file from the style sheet.

---

**Note:** Two tables show the association of the style sheets and the images. [Table 5–4](#) shows files relative to *root-dir/* and [Table 5–5](#) shows files relative to *root-dir/framework/skins/ext-name*. There is no special significance that the files are grouped this way except to improve the readability of the tables.

---

Other images than the ones listed in the tables are also used in the console, and some are referenced in the style sheets. However, these tables only show those that are used to create formatting effects, as mentioned above. Browse *root-dir/framework/skins/ext-name/images/* and *root-dir/images/* to see the other images.

**Table 5–4 Images Used With Style Sheets (Under *root-dir/*)**

Effect	CSS File	Image file
The surface of a button. See also use of this image with <i>login.css</i> .	<i>css/forms.css</i>	<i>images/button_bg_n.png</i>
The surface of a button when the mouse pointer rolls over it. See also use of this image with <i>login.css</i> .	<i>css/forms.css</i>	<i>images/button_bg_mo.png</i>
The surface of a button when it is pressed down. See also use of this image with <i>login.css</i> .	<i>css/forms.css</i>	<i>images/button_bg_md.png</i>
The background of the Welcome box that prompts for Username and Password when first starting WebLogic Server.	<i>css/login.css</i>	<i>framework/skins/ext-name/images/Loginarea_Background.png</i>
The surface of the Log In button in the Welcome box. See also use of this image in <i>forms.css</i> , listed above.	<i>css/login.css</i>	<i>images/button_bg_n.png</i>
The surface of a button when the mouse pointer rolls over it. See also use of this image in <i>forms.css</i> , listed above.	<i>css/login.css</i>	<i>images/button_bg_mo.png</i>
The surface of a button when it is pressed down. See also use of this image in <i>forms.css</i> , listed above.	<i>css/login.css</i>	<i>images/button_bg_md.png</i>
The background of the Login page.	<i>css/login.css</i>	<i>framework/skins/ext-name/images/Login_GC_LoginPage_Bg.gif</i>

**Table 5–5 Images Used With Style Sheets (Under `root-dir/framework/skins/ext-name/`)**

Effect	CSS File	Image file
Title bar at top of panels	<code>css/window.css</code>	<code>images/titlebar_bg.png</code>
Background for entire console. Visible at top of console behind logo.	<code>css/console.css</code>	<code>images/r_bg_global.png</code>
The left edge of a tab. The top half of the image is used for unselected tabs and the bottom half is used for selected tabs.	<code>css/menu.css</code>	<code>images/tab_left.gif</code>
The main surface of a tab. The top half of the image is used for unselected tabs and the bottom half is used for selected tabs.	<code>css/console.css</code>	<code>images/tab_right.gif</code>
The corner of a shadow behind a panel. With default settings, it is at the top and bottom right corners.	<code>css/window.css</code>	<code>images/shadow-corners</code>
The right side of a shadow behind a panel.	<code>css/window.css</code>	<code>images/shadow-right.gif</code>
The bottom of a shadow behind a panel.	<code>css/window.css</code>	<code>images/shadow-bottom.gif</code>

## 5.5 Use a Message Bundle for Your Look and Feel

In the banner and login pages, the Administration Console uses JSTL tags to load text messages from localized properties files. For example, to display the window title in `LoginForm.jsp`:

1. The `<fmt:setBundle basename="global" var="current_bundle" scope="page" />` tag in `LoginForm.jsp` sets the current message bundle to `global`.

This JSP tag looks in `WEB-INF/classes` for files with the following name pattern:

```
bundle[_locale].properties.
```

The default properties file for this bundle is `global.properties` in `WL_HOME/server/lib/consoleapp/webapp/WEB-INF/classes/console.jar`. If the Web browser or operating system specifies a different locale, then the JSP tag would load `global_locale.properties`.

2. The `<fmt:message key="window.title" bundle="${current_bundle}" />` tag opens the `global.properties` file and renders the text that is identified by the `window.title` key:

```
window.title=Oracle WebLogic Server Administration Console
```

If you want to change these messages, you can create your own properties files and modify the JSP tags to use your bundle. See [Chapter 4, "Creating a Message Bundle."](#)

[Table 5–6](#) describes the text messages that the banner, login, and login error pages display.

**Table 5–6 Messages in Banner and Login Pages**

File (Under <i>root-dir</i> /)	Message Key and Value
login/LoginForm.jsp	window.title=Oracle WebLogic Server Administration Console login.wlsident=Oracle WebLogic Server Administration Console login.welcome2=Log in to work with the WebLogic Server domain login.username=Username: login.password=Password: login.submit=Log In
framework/skeleton/mycompany/header.jsp	window.title=Oracle WebLogic Server Administration Console

## 5.6 Create a NetUI Extension File

A NetUI Extension file, named `netuix-extension.xml`, is the deployment descriptor for your Look and Feel. It contains the names and locations of the files in your Look and Feel, and it causes the Administration Console to replace its Look and Feel with yours. See [Section 5–1, "netuix-extension.xml"](#). For more information about this file, see the *NetUI Extensions Schema Reference*.

### Example 5–1 `netuix-extension.xml`

```
<?xml version="1.0" encoding="UTF-8"?>
<weblogic-portal-extension
  xmlns="http://www.bea.com/servers/portal/weblogic-portal/8.0"
  xmlns:xsi="http://www.w3.org/2001/XMLSchema-instance"

  xsi:schemaLocation="http://www.bea.com/servers/portal/weblogic-portal/8.0
  netuix-extension-1_0_0.xsd">

  <provider-info>
    <title>My LAF</title>
    <version>1.0</version>
    <description>My LAF.</description>
    <author>Me</author>
    <support-url>My URL</support-url>
  </provider-info>

  <portal-file>/console.portal</portal-file>
  <desktop-extension>
    <look-and-feel-content title="myLAF"
      definitionLabel="myLAF"
      markupName="myLookAndFeel"
      skin="myLAF"
      skin-path="/framework/skins"
      skeleton="myLAF"
      skeleton-path="/framework/skeletons"
      default-window-icon="window-icon.gif"
      default-window-icon-path="images/" />
  </weblogic-portal-extension>
```

To modify this file:

1. Open the file in a validating XML editor (recommended) or a text editor.
2. In the `<provider-info>` element, change the information to describe your Look and Feel, developer contact and support URL.

The information in this element has no programmatic significance. It is intended to help your technical support team keep track of your software modifications.

3. In the `<look-and-feel-content>` element:
  - a. In the `title`, `skin`, and `skeleton` attributes, replace the `myLAF` value with the name of the directory you chose in step 3 in [Section 5.3, "Expand the Look and Feel Template."](#)
  - b. In the `definitionLabel` and `markupName` attributes, replace the `myLAF` value with the name of the directory you chose in step 2 or use some other string. These attributes are required by the portal framework, but are not used in a Look and Feel extension.

## 5.7 Archive and Deploy the Extension

For instructions on how to archive and deploy the extension, see [Chapter 9, "Archiving and Deploying Console Extensions."](#)





## Adding Portlets and Navigation Controls

This chapter describes how to add portlets, UI controls, and NavTreePortlet nodes to the WebLogic Server Administration Console.

In the Administration Console, all content is contained within portlets, so even the most minimal extension must define a portlet (and content for the portlet). You can add your portlet directly to the desktop, but if you want the portlet to display as a tab or subtab in the ContentBook, you must define books or pages to contain it. Your extension can also add a node to the NavTreePortlet, which enables users to navigate to your portlet directly from the desktop.

Figure 6-1 illustrates the process. The steps in the process, and the results of each are described in Table 6-1. Subsequent sections detail each step in the process.

**Figure 6-1 Adding Portlets and Navigation Controls Development Overview**

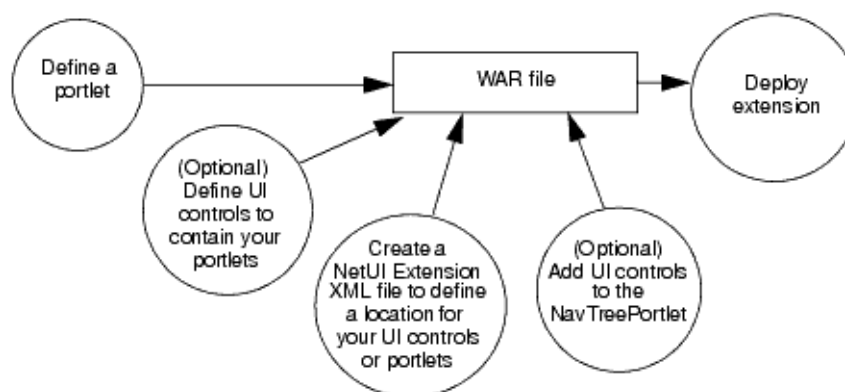

**Table 6-1 Model MBean Development Tasks and Results**

Step	Description	Result
1. <a href="#">Section 6.1, "Define a Portlet."</a>	Create an XML file to define a portlet that the portal framework can instantiate. A portlet definition includes instructions on which type of data to load: JSPs, Struts Actions, or Beehive Page Flows.  The portal's Look and Feel determines whether the portlet provides borders and minimize/maximize controls.	A .portlet XML file.
2. <a href="#">Section 6.2, "Define UI Controls (Optional)."</a>	If you want your portlet to display in a tab, subtab, or in some other location within ContentBook, create an XML file that defines a page or book.	A .book XML file.

**Table 6–1 (Cont.) Model MBean Development Tasks and Results**

Step	Description	Result
3. <a href="#">Section 6.3, "Specify a Location for Displaying Portlets or UI Controls."</a>	Create an XML file that describes whether you want your portal to display next to a labeled UI control or to replace the control.	A <code>netuix-extension.xml</code> file.
4. <a href="#">Section 6.4, "Add Nodes to the NavTreePortlet (Optional)."</a>	You can create a link from the NavTreePortlet to any book or page in your extension.  WebLogic Server provides default support for appending control names to the end of the existing navigation tree. If you want to insert nodes in specific locations, or if you want to create a node tree, you create your own Java classes that describe the node and node location.	Additional entries in the <code>.book</code> XML file.  Optionally, Java classes that give you more control over the node that you are adding.
5. Archive and deploy the extension.	See <a href="#">Chapter 9, "Archiving and Deploying Console Extensions."</a>	A WAR file that contains your extension.

## 6.1 Define a Portlet

You define a portlet in an XML file. The portlet definition includes instructions on which type of data to load: JSPs, Struts Actions, or Beehive Page Flows. The following sections describe how to define a portlet:

- [Section 6.1.1, "Define a JSP Portlet"](#)
- [Section 6.1.2, "Define a Struts Portlet"](#)
- [Section 6.1.3, "Define a Page Flow Portlet"](#)
- [Section 6.1.4, "Displaying a Title Bar for a Portlet"](#)

For more information about portlet XML files, see the entry in *Portal Support Schema Reference*.

### 6.1.1 Define a JSP Portlet

To define a portlet that loads a JSP:

1. Copy the code from [Example 6–1](#) and paste it into a new text file in `root-dir/portlets` (see [Section 3.3, "Create a Directory Tree for the Extension"](#)).

Consider using the following naming convention:

```
content-name.portlet
```

where `content-name` is the name of a JSP file that the portlet contains. For example, if the portlet contains a JSP file named `monitorEJB.jsp`, then name the portlet XML file `monitorEJB.portlet`.

2. Replace the values in [Example 6–1](#) as follows:
  - *Label*. Provide a unique identifier that the portal framework uses to identify this portlet.
  - (optional) *Title*. Provide a default title that this portlet displays if its title bar is visible. See [Section 6.1.4, "Displaying a Title Bar for a Portlet."](#)

- *URI*. Specifies the absolute path and file name of the JSP that the portlet contains starting from the root of the extension.

For example:

```
/ext_jsp/monitorEJB.JSP
```

You must precompile JSPs before deploying your extension.

#### Example 6–1 Template for a Portlet XML File that Loads a JSP File

```
<?xml version="1.0" encoding="UTF-8"?>
<portal:root xmlns:html="http://www.w3.org/1999/xhtml-netuix-modified/1.0.0"
  xmlns:portal="http://www.bea.com/servers/netuix/xsd/portal/support/1.0.0"
  xmlns:netuix="http://www.bea.com/servers/netuix/xsd/controls/netuix/1.0.0"
  xmlns:xsi="http://www.w3.org/2001/XMLSchema-instance"
  xsi:schemaLocation="http://www.bea.com/servers/netuix/xsd/portal/
    support/1.0.0 portal-support-1_0_0.xsd">
  <netuix:portlet definitionLabel="Label" title="Title" >
    <netuix:content>
      <netuix:jspContent contentUri="URI" />
    </netuix:content>
  </netuix:portlet>
</portal:root>
```

## 6.1.2 Define a Struts Portlet

Instead of encapsulating your extension's business logic and navigation logic in JSP files, you can use the Apache Struts framework. See [Section 7.3, "Create Struts Artifacts for Tables and Forms."](#)

To create a portlet that loads (forwards to) a Struts Action:

1. Copy the code from [Example 6–2](#) and paste it into a new text file in *root-dir/portlets* (see [Section 3.3, "Create a Directory Tree for the Extension"](#)).

Consider using the following naming convention:

```
action-name.portlet
```

where *action-name* is the name of the Struts Action to which the portlet forwards.

2. Replace the values in [Example 6–2](#) as follows:
  - *Label*. Provide a unique identifier that the portal framework uses to identify this portlet.
  - (optional) *Title*. Provide a default title that this portlet displays if its title bar is visible. See [Section 6.1.4, "Displaying a Title Bar for a Portlet."](#)
  - *Struts-module*. Specifies the Struts module that defines a Struts Action.

You must create your own Struts module to define the Actions and ActionForms that your Administration Console extension uses; the default Struts module is reserved for Oracle Actions and ActionForms. Each module includes its own, uniquely named configuration file. For information about Struts modules, see the Apache Struts *User Guide* at <http://struts.apache.org/struts-doc-1.2.x/userGuide/index.html>.

For example, if you specify "myModule" for *Struts-module*, the Struts controller servlet looks in the following location for the action:

```
root-dir/WEB-INF/struts-auto-config-myModule.xml
```

- *action-path*. Specifies the path to a Struts Action that is defined in your Struts module.
- *refresh-action-path*. Specifies the Action to invoke on subsequent requests for this portlet (for example, the user agent refreshes the document).

Note that this `.portlet` does not specify the name of a JSP. Instead, typically the Struts Action mapping forwards to a specific JSP upon successful operation.

### Example 6–2 Template for a Portlet XML File that Forwards to a Struts Action

```
<?xml version="1.0" encoding="UTF-8"?>
<portal:root xmlns:html="http://www.w3.org/1999/xhtml-netuix-modified/1.0.0"
  xmlns:portal="http://www.bea.com/servers/netuix/xsd/portal/support/1.0.0"
  xmlns:netuix="http://www.bea.com/servers/netuix/xsd/controls/netuix/1.0.0"
  xmlns:xsi="http://www.w3.org/2001/XMLSchema-instance"
  xsi:schemaLocation="http://www.bea.com/servers/netuix/xsd/portal/
    support/1.0.0 portal-support-1_0_0.xsd">
  <netuix:portlet definitionLabel="Label" title="Title" >
    <netuix:strutsContent module="Struts-module"
      action="action-path"
      refreshAction="refresh-action-path" />
  </netuix:portlet>
</portal:root>
```

## 6.1.3 Define a Page Flow Portlet

To define a portlet that loads a Beehive Page Flow:

1. Copy the code from [Example 6–3](#) and paste it into a new text file in `root-dir/portlets` (see [Section 3.3, "Create a Directory Tree for the Extension"](#)).

Consider using the following naming convention:

```
pageFlow-name.portlet
```

where *pageFlow-name* is the name of the Page Flow that the portlet loads (forwards to). For example, if the portlet forwards to a Page Flow named `myPageFlow.jpf`, then name the portlet XML file `myPageFlow.portlet`.

2. Replace the values in [Example 6–3](#) as follows:
  - *Label*. Provide a unique identifier that the portal framework uses to identify this portlet.
  - (optional) *Title*. Provide a default title that this portlet displays if its title bar is visible. See [Section 6.1.4, "Displaying a Title Bar for a Portlet."](#)
  - *URI*. Specifies the absolute path and file name of the JPF file that defines the Page Flow. The URI must be absolute starting from the `root-dir/WEB-INF/classes` directory.

For example, if your JPF file is

```
root-dir/WEB-INF/classes/com/mycompany/extension/pageflows
/myPageFlow.jpf, specify the following value
```

```
/com/mycompany/extension/pageflows/myPageFlow.jpf
```

- *Action*. Specifies the absolute path and file name of the JPF file that defines the Page Flow.

### Example 6–3 Template for a Portlet XML File that Forwards to a Page Flow

```
<?xml version="1.0" encoding="UTF-8"?>
<portal:root xmlns:html="http://www.w3.org/1999/xhtml-netuix-modified/1.0.0"
  xmlns:portal="http://www.bea.com/servers/netuix/xsd/portal/support/1.0.0"
  xmlns:netuix="http://www.bea.com/servers/netuix/xsd/controls/netuix/1.0.0"
  xmlns:xsi="http://www.w3.org/2001/XMLSchema-instance"
  xsi:schemaLocation="http://www.bea.com/servers/netuix/xsd/portal/
    support/1.0.0 portal-support-1_0_0.xsd">
  <netuix:portlet definitionLabel="Label" title="Title" >
    <netuix:content>
      <netuix:pageflowContent
        contentUri="URI"
        action="Action" />
      <netuix:refreshAction refreshAction="refresh-Action" />
    </netuix:content>
  </netuix:portlet>
</portal:root>
```

## 6.1.4 Displaying a Title Bar for a Portlet

If you plan to locate a portlet on the Administration Console desktop (within a placeholder on the "page" page), configure the portlet to display a title bar. If you locate a portlet in the ContentBook, do not display a title bar.

To display a title bar:

1. In the portlet's .portlet XML file, provide a value for the `title` attribute of the `netuix:portlet` element. To display a localized value, see [Section 6.1.4.1, "Localizing a Portlet Title."](#)
2. Include the following element as a child of the `netuix:portlet` element:

```
<netuix:titlebar/>
```

To enable the portlet to be minimized and maximized, include the following stanza instead of the empty `<netuix:titlebar/>` element:

```
<netuix:titlebar>
  <netuix:minimize/>
  <netuix:maximize/>
</netuix:titlebar>
```

[Example 6–4](#) defines a portlet that displays a title bar. The portlet can be minimized or maximized and the title value comes from a message bundle.

### Example 6–4 Example: Portlet that Displays a Localized Title

```
<?xml version="1.0" encoding="UTF-8"?>
<portal:root xmlns:html="http://www.w3.org/1999/xhtml-netuix-modified/1.0.0"
  xmlns:portal="http://www.bea.com/servers/netuix/xsd/portal/support/1.0.0"
  xmlns:netuix="http://www.bea.com/servers/netuix/xsd/controls/netuix/1.0.0"
  xmlns:xsi="http://www.w3.org/2001/XMLSchema-instance"
  xsi:schemaLocation="http://www.bea.com/servers/netuix/xsd/portal/
    support/1.0.0 portal-support-1_0_0.xsd">
  <netuix:portlet definitionLabel="medrecEAR.Monitor.Portlet"
    title="medrecMBean.myPortlet.title"
    backingFile="com.bea.medrec.extension.utils.DesktopViewBacking">
```

```

<netuix:titlebar>
  <netuix:minimize/>
  <netuix:maximize/>
</netuix:titlebar>
<netuix:content>
  <netuix:strutsContent module="/medrecMBean"
    action="RetrieveCustomMBeansAction"
    refreshAction="RetrieveCustomMBeansAction"/>
</netuix:content>
</netuix:portlet>
</portal:root>

```

#### 6.1.4.1 Localizing a Portlet Title

By default, the portlet displays the literal value that you enter in the `<netuix:portlet>` element's `title` attribute. To enable this title to be localized:

1. Create a Java class that retrieves the value of the `title` attribute, scans a property file for a key that matches the `title` attribute value, and returns the value of the property key.

For example, if you specify `title="myPortlet.title"`, the Java class looks through your message bundle for `myPortlet.title=MyCompany's Portlet` and returns `MyCompany's Portlet` as the text to be displayed.

See [Section 6.1.4.1.1, "Create a Backing Class for Localizing Portlet Titles."](#)

2. In the `.portlet` file, include the following attributes in the `<netuix:portlet>` element:
  - `title`. Specify the key for a property that you have defined in your message bundle.
  - `backingFile`. Specify the fully-qualified name of a Java class that you created in the previous step.

For example:

```

<netuix:portlet definitionLabel="myPortlet" title="myPortlet.title"
  backingFile="com.mycompany.extension.utils.MyPortletBacking">

```

**6.1.4.1.1 Create a Backing Class for Localizing Portlet Titles** A backing class is a Java class that interacts directly with the portal framework APIs. To create a backing class that retrieves localized portlet titles:

1. Extend `com.bea.netuix.servlets.controls.content.backing.AbstractJspBacking`.
2. Implement the `AbstractJspBacking.preRender(HttpServletRequest request, HttpServletResponse response)` method.

In your implementation of this method:

- a. Get the locale from the `HttpServletRequest` object.

Use the following API:

```

javax.servlet.http.HttpServletRequest.getSession().getAttribute(
  "org.apache.struts.action.LOCALE")

```

- b. Get the message bundle.

Use the following API:

```
org.apache.struts.util.MessageResources.getMessageResources (
    "myBundle");
```

where *myBundle* is the name of your message bundle. (See [Section 4, "Creating a Message Bundle."](#))

- c. Get the value of the portlet's title property.

Use the following APIs:

```
PortletBackingContext bctx =
    PortletBackingContext.getPortletBackingContext (
        HttpServletRequest req);
MessageResources.getMessage(locale, bctx.getTitle());
```

where *locale* is the locale that you retrieved from the `HttpServletRequest` object.

- d. Reset the value of the portlet's title property to the localized value that you retrieved in the previous step.

Use the following API:

```
PortletBackingContext.getTitle(String title)
```

where *title* is the value that you retrieved from the message bundle.

#### **Example 6-5 Example: Backing Class for Localizing a Portlet Title**

```
package com.bea.medrec.extension.utils;
import java.util.Locale;
import javax.servlet.http.HttpServletRequest;
import javax.servlet.http.HttpServletResponse;
import org.apache.struts.util.MessageResources;
import com.bea.netuix.servlets.controls.content.backing.AbstractJspBacking;
import com.bea.netuix.servlets.controls.portlet.backing.PortletBackingContext;
public class DesktopViewBacking extends AbstractJspBacking {
    public boolean preRender(HttpServletRequest req, HttpServletResponse res) {
        // Get the PortletBackingContext for current portlet. The
        // PortletBackingContext contains properties and methods
        // for the current portlet.
        PortletBackingContext bctx =
            PortletBackingContext.getPortletBackingContext(req);
        if (bctx != null) {
            // If title does not contain a period, assume it's preLocalized
            // or follow the format for a key
            if (bctx.getTitle().indexOf(".")!=-1){
                // Get the locale from the HttpServletRequest
                Locale locale = (Locale) req.getSession().getAttribute(
                    "org.apache.struts.action.LOCALE");
                // Find the message bundle named "medrecMBean"
                MessageResources messages =
                    MessageResources.getMessageResources("medrecMBean");
                // Get the value of the portlet's "title" property
                String msg = messages.getMessage(locale, bctx.getTitle());
                // Reset the value of the "title" property with the
                // localized value.
                bctx.setTitle(msg);
            }
        }
        return true;
    }
}
```

```
    }
}
```

## 6.2 Define UI Controls (Optional)

If you want to add tabs or subtabs to the Administration Console, you must define a book or page UI control that conforms to the existing hierarchy:

- To create a top-level tab (such as a sibling of Domains: Configuration), you create a book that contains one or more pages. Each page contains a portlet.
- To create a subtab of an existing tab (such as a sibling of Domains: Configuration: General), you create a page that contains a portlet.

Save the definitions of your books and pages in one or more portal book (`.book`) files. Create one `.book` file for each hierarchical grouping of controls. For example, create one `.book` file for a book that creates a top-level tab and its subtabs. Create another `.book` file for a page that adds a subtab to an existing WebLogic Server tab. The root element of a `.book` file (`portal:root`) can have only one direct child element; the child element can have multiple children.

The following sections describe creating books and pages:

- [Section 6.2.1, "Create a Tab That Does Not Contain a Subtab"](#)
- [Section 6.2.2, "Create a Tab That Contains Subtabs"](#)
- [Section 6.2.3, "Create a Subtab"](#)
- [Section 6.2.4, "Create a Control Without Tabs or Subtabs"](#)

### 6.2.1 Create a Tab That Does Not Contain a Subtab

To create a portal book (`.book`) XML file that defines a tab and no subtabs (such as Domains: Notes):

1. Copy the code from [Example 6–6](#) and paste it into a new text file.

For example, `root-dir/controls/MyApp.book`

where `root-dir` is your development directory. For more information, see [Chapter 3, "Setting Up a Development Environment."](#)

2. Replace the values in [Example 6–6](#) as follows:

- *Page-Label*. Provide a unique identifier that the portal framework and WebLogic Server JSP tags use to forward requests to the page.
- *Page-Title*. Provide either the text that users see as the name of the tab or a key in a message bundle that you have created.

If the value that you specify contains a "." (period), the Administration Console assumes that this value is a key and attempts to look up the value from your message bundle. For example, if you specify `My.Tab`, the Administration Console looks up the value of a property whose key is `My.Tab`. If it cannot find such a value, it displays `null` as the tab name. If you specify `My Tab` as the value, then the Administration Console displays `My Tab`.

- *Bundle*. Specify the name of a message bundle that you have created. This bundle is used only if the value of the `title` attribute in the `netuix:page` element contains a ".". See [Section 7.1, "Create and Use a Message Bundle in Your JSPs."](#)



- *Portlet-Instance-Label*. Provide a unique identifier that the portal framework and WebLogic Server JSP tags use to forward requests to the portlet instance.
- *Portlet-URI*. Specify the path and file name of a portlet file that you created (see [Section 6.1, "Define a Portlet"](#)). The path must be relative to the root of the portal Web application.

For example:

```
/portlets/monitorEJB.portlet
```

Note that [Example 6–6](#) defines a page, not a book, so the Administration Console Look and Feel will render the page as a tab with no subtabs.

#### **Example 6–6 Template .book File that Creates a Tab with No Subtabs**

```
<?xml version="1.0" encoding="UTF-8"?>
<portal:root
  xmlns:netuix="http://www.bea.com/servers/netuix/xsd/controls/netuix/1.0.0"
  xmlns:html="http://www.w3.org/1999/xhtml-netuix-modified/1.0.0"
  xmlns:xsi="http://www.w3.org/2001/XMLSchema-instance"
  xmlns:portal="http://www.bea.com/servers/netuix/xsd/portal/support/1.0.0"
  xsi:schemaLocation="http://www.bea.com/servers/netuix/xsd/portal/support
    /1.0.0 portal-support-1_0_0.xsd">
  <netuix:page markupName="page" markupType="Page"
    definitionLabel="Page-Label" title="Page-Title"
    skeletonUri="/framework/skeletons/default/wlsworkspace/
      page_content.jsp">
    <netuix:meta name="skeleton-resource-bundle" content="Bundle"/>
    <netuix:content>
      <netuix:gridLayout columns="1" markupType="Layout"
        markupName="singleColumnLayout">
        <netuix:placeholder flow="vertical" markupType="Placeholder"
          markupName="singleColumn_columnOne">
          <netuix:portletInstance markupType="Portlet"
            instanceLabel="Portlet-Instance-Label"
            contentUri="Portlet-URI" />
        </netuix:placeholder>
      </netuix:gridLayout>
    </netuix:content>
  </netuix:page>
</portal:root>
```

## 6.2.2 Create a Tab That Contains Subtabs

To create a portal book (.book) XML file that defines a tab and one or more subtabs:

1. Copy the code from [Example 6–7](#) and paste it into a new text file. Save the file in a directory below *root-dir*.

For example, *root-dir/controls//MyApp.book*

where *root-dir* is your development directory. For more information, see [Chapter 3, "Setting Up a Development Environment."](#)

2. To define the tab, replace the values in [Example 6–7](#) as follows:
  - *Book-Label*. Provide a unique identifier that the portal framework and WebLogic Server JSP tags use to forward requests to the book. This is the same

type of label that WebLogic Server provides for many of its UI controls. See [Section 2.2, "Extension Points in the Administration Console."](#)

- *Book-Title*. Provide either the text that users see as the name of the tab or a key in a message bundle that you have created.

If the value that you specify contains a "." (period), the Administration Console assumes that this value is a key and attempts to look up the value from your message bundle. For example, if you specify `My.Tab`, the Administration Console looks up the value of a property whose key is `My.Tab`. If it cannot find such a value, it displays `null` as the tab name. If you specify `My Tab` as the value, then the Administration Console displays `My Tab`.

- *Bundle*. Specify the name of a message bundle that you have created. This bundle is used only if the value of the `title` attribute in the `netuix:book` element contains a ".". See [Section 7.1, "Create and Use a Message Bundle in Your JSPs."](#)

3. To define the first subtab, replace the values in [Example 6–7](#) as follows:

- *Page-Label*. Provide a unique identifier that the portal framework and WebLogic Server JSP tags use to forward requests to the page.
- *Page-Title*. Provide either the text that users see as the name of the subtab or a key in a message bundle that you have created.

If the value that you specify contains a "." (period), the Administration Console assumes that this value is a key and attempts to look up the value from your message bundle.

- (optional) *Metadata-Type* and *Metadata-ID*. If you want to use the Administration Console's `<wl:column-dispatch>` JSP tag to create a hypertext link that forwards to this page, include a `<netuix:meta>` element and supply values for *Metadata-Type* and *Metadata-ID*. See [Section 7.4.4, "Create a Table Column for Navigating to Other Pages."](#)
- *Portlet-Instance-Label*. Provide a unique identifier that the portal framework and WebLogic Server JSP tags use to forward requests to the portlet instance.
- *Portlet-URI*. Specify the path and file name of a portlet file that you created (see [Section 6.1, "Define a Portlet"](#)). The path must be relative to the root of the portal Web application.

For example:

```
/portlets/monitorEJB.portlet
```

4. To create additional subtabs, add `netuix:page` elements as siblings to the `netuix:page` element in [Example 6–7](#).

For more information about portal book XML files, see the *Portal Support Schema Reference*.

Note the use of the following elements in the `.book` file:

- `netuix:singleLevelMenu` renders one subtab for each page in the book. The book's parent UI control (which [Example 6–7](#) assumes is provided by WebLogic Server) is responsible for generating a top-level tab for the book.

- `netuix:meta name="breadcrumb-context" content="handle"` adds the page's title to the history of visited pages (breadcrumbs) after a user has visited the page. The breadcrumbs display on the desktop above ContentBook.

### Example 6–7 Template for a .book File That Defines a Top-Level Tab with Subtabs

```
<?xml version="1.0" encoding="UTF-8"?>
<portal:root
  xmlns:netuix="http://www.bea.com/servers/netuix/xsd/controls/netuix/1.0.0"
  xmlns:html="http://www.w3.org/1999/xhtml-netuix-modified/1.0.0"
  xmlns:xsi="http://www.w3.org/2001/XMLSchema-instance"
  xmlns:portal="http://www.bea.com/servers/netuix/xsd/portal/support/1.0.0"
  xsi:schemaLocation="http://www.bea.com/servers/netuix/xsd/portal/support
    /1.0.0 portal-support-1_0_0.xsd">
  <netuix:book markupName="book" markupType="Book"
    definitionLabel="Book-Label" title="Book-Title">
    <netuix:singleLevelMenu markupType="Menu" markupName="singleLevelMenu"
      skeletonUri="singlelevelmenu_children.jsp" />
    <netuix:meta name="skeleton-resource-bundle" content="Bundle" />
    <netuix:content>
      <netuix:page markupName="page" markupType="Page"
        definitionLabel="Page-Label" title="Page-Title"
        skeletonUri="/framework/skeletons/default/wlsworkspace/
          page_content.jsp">
        <netuix:meta name="Metadata-Type" content="Metadata-ID" />
        <netuix:meta name="breadcrumb-context" content="handle" />
        <netuix:meta name="skeleton-resource-bundle" content="Bundle" />
        <netuix:content>
          <netuix:gridLayout columns="1" markupType="Layout"
            markupName="singleColumnLayout">
            <netuix:placeholder flow="vertical" markupType="Placeholder"
              markupName="singleColumn_columnOne">
              <netuix:portletInstance markupType="Portlet"
                instanceLabel="Portlet-Instance-Label"
                contentUri="Portlet-URI" />
            </netuix:placeholder>
          </netuix:gridLayout>
        </netuix:content>
      </netuix:page>
      <!-- Add additional netuix:page elements here -->
    </netuix:content>
  </netuix:book>
</portal:root>
```

## 6.2.3 Create a Subtab

To create a subtab that you can add to an existing WebLogic Server tab:

1. Create a `.book` file that defines a page UI control. See [Example 6–6](#).
2. In your `netuix-extension.xml` file, specify the WebLogic Server book UI control that you want to contain your subtab. See [Section 6.3.2, "Add a Tab or Subtab to ContentBook."](#)

## 6.2.4 Create a Control Without Tabs or Subtabs

There is no requirement for books and pages in ContentBook to be accessible by tab or subtab. Many WebLogic Server pages that display summary tables are accessible from the NavTreePortlet but not from the tabbed interface (see [Figure 2–5](#)).

Any of the code listings in the previous sections can be located in a parent control that does not render tabs or subtabs for its children. See [Section 6.3, "Specify a Location for Displaying Portlets or UI Controls."](#)

## 6.3 Specify a Location for Displaying Portlets or UI Controls

All locations for displaying your portlets or UI controls must be specified as relative to existing controls in the Administration Console. For example, you can specify that your portlet displays on the desktop below the System Status portlet.

To specify a location for displaying a portlet or UI control:

1. Create an XML file named `netuix-extension.xml` and save it in
2. `root-dir/WEB-INF`
3. where `root-dir` is your development directory. For more information, see [Chapter 3, "Setting Up a Development Environment."](#)

A NetUI Extension XML file (`netuix-extension.xml`) is the deployment descriptor for your extension. It declares each parent UI control in your extension and the location in which you want it to display (see [Example 6-8](#)). For more information, see the NetUI Extensions Schema Reference.

4. Create a `<weblogic-portal-extension>` root element.
5. (Optional) Create a `<provider-info>` element to describe your extension.

This element is for your information only. The portal framework does not use the data in this element.

6. Add the following element:
7. `<portal-file>/console.portal</portal-file>`

This required element specifies the name and relative location of the Administration Console's `.portal` file, which is the portal that you are extending.

8. Do one of the following:
  - [Section 6.3.1, "Add a Portlet to the Desktop"](#)
  - [Section 6.3.2, "Add a Tab or Subtab to ContentBook"](#)

### 6.3.1 Add a Portlet to the Desktop

To add a portlet to the Administration Console desktop, create the following stanza in your `netuix-extension.xml` file (see [Example 6-8](#)):

```
<page-extension>
  <page-location>
    <parent-label-location label="page"/>
    <page-insertion-point layout-location="layout"
      placeholder-position="0"/>
  </page-location>
  <portlet-content>
    content-uri="portlet-URI" title="title"
    orientation="top" default-minimized="false"
    instance-label="portlet-instance-label"/>
</page-extension>
```

where:

- `layout` is one of the following values:

- 0 (zero) if you want the portlet to display in the left side of the Administration Console.  
Extension portlets always display at the top of the left column.
- 1 (one) if you want the portlet to display in the right side.  
Extension portlets always display at the bottom of the right column.
- *portlet-URI* is the path and file name of your `.portlet` file. The path must be relative to the root of the portal Web application.
- *title* is the title that displays in the portlet's title bar. If you specify a null value, the portal framework uses the title that you defined in the `.portlet` file.
- *portlet-instance-label* is a unique identifier that the portal framework and WebLogic Server JSP tags use to forward requests to the portlet instance.

### 6.3.2 Add a Tab or Subtab to ContentBook

To add a control that renders a tab, create the following stanza in your `netuix-extension.xml` file (see [Example 6–8](#)):

```
<book-extension>
  <book-location>
    <parent-label-location label="Admin-Console-Book-Label"/>
    <book-insertion-point action="append"/>
  </book-location>
  <book-content content-uri="book-URI"/>
</book-extension>
```

where:

- *Admin-Console-Book-Label* is the `definitionLabel` of an Administration Console book control that renders tabs for its child books.
- *book-URI* is the path and file name of your `.book` file that defines the book control for your tab (and optional subtabs). The path must be relative to the root of the portal Web application.

To add a control that renders a subtab in an existing tab, create the same stanza as the previous step, where:

- *Admin-Console-Book-Label* is the `definitionLabel` of an Administration Console book control that renders subtabs for its child pages.
- *book-URI* is the path and file name of your `.book` file that defines the page control for your subtab. The path must be relative to the root of the portal Web application.

### 6.3.3 Example: Specifying Locations for Portlets and UI Controls

[Example 6–8](#) is a `netuix-extension.xml` file that adds a tab to the WebLogic Sever Domain tabs, a subtab to the Domain: Configuration tab, and a portlet to the console desktop.

#### **Example 6–8 Example netuix-extension.xml File**

```
<?xml version="1.0" encoding="UTF-8"?>
<weblogic-portal-extension
  xmlns="http://www.bea.com/servers/portal/weblogic-portal/8.0"
  xmlns:xsi="http://www.w3.org/2001/XMLSchema-instance"
  xsi:schemaLocation="http://www.bea.com/servers/portal/weblogic-portal/
```

```

    8.0 netuix-extension-1_0_0.xsd">
<provider-info>
  <title>My Extension</title>
  <version>1.0</version>
  <description>Inserts a portlet on the desktop, a tab next to
    Domains:Configuration, and a subtab under Domains: Configuration.
  </description>
  <author>Me</author>
  <last-modified>02/03/2005</last-modified>
  <support-url>http://www.mycompany/support/index.jsp</support-url>
</provider-info>
<portal-file>/console.portal</portal-file>
<!--Adds a tab to the Domain tabs -->
<book-extension>
  <book-location>
    <parent-label-location label="CoreDomainConfigGeneralBook"/>
    <book-insertion-point action="append"/>
  </book-location>
  <book-content content-uri="/controls/page.book"/>
</book-extension>
<!-- Adds a subtab to the Domain: Configuration tab-->
<book-extension>
  <book-location>
    <parent-label-location label="DomainconfigTabPage"/>
    <book-insertion-point action="append"/>
  </book-location>
  <page-content content-uri="/controls/notespage.book"/>
</book-extension>
<!--Adds a portlet to the console desktop -->
<page-extension>
  <page-location>
    <parent-label-location label="page"/>
    <page-insertion-point layout-location="0" placeholder-position="0"/>
  </page-location>
  <portlet-content content-uri="/portlets/desktop/desktop_view.portlet"
    title="My App Status" orientation="top" default-minimized="false"
    instance-label="PortletExtensionInstanceLabel"
  />
</page-extension>
</weblogic-portal-extension>

```

## 6.4 Add Nodes to the NavTreePortlet (Optional)

The Domain Structure portlet (NavTreePortlet) contains a tree control that you can use to navigate to content in the Administration Console. Each node in the tree is a link to a UI page control. Nodes can also contain subnodes.

Your extension can add a single node at any location in the tree. It can also add a node that contains other nodes (node tree) at any location. For example, your extension can add a node or a node tree to the root of the existing navigation tree. In addition (or instead), it can add a node or node tree to the Environments node. (See [Figure 6-2](#).)

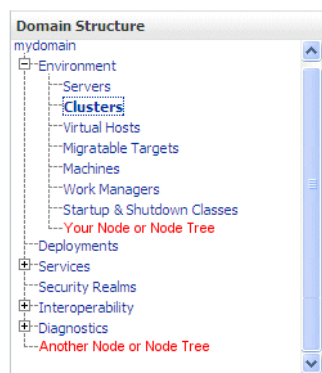
**Figure 6–2 Example: Adding Nodes or Node Trees**

The following sections describe adding nodes to the NavTreePortlet:

- [Section 6.4.1, "Append a Single Node to the Root of the Existing Tree"](#)
- [Section 6.4.2, "Append or Insert Nodes or Node Trees"](#)

### 6.4.1 Append a Single Node to the Root of the Existing Tree

To append a node that links to one of your page controls, add the following attribute and attribute value to the `netuix:page` element in the control's `.book` file:

```
backingFile="com.bea.console.utils.NavTreeExtensionBacking"
```

For example, if you want to add a link to a page that you have created, in the `.book` file that defines your page, add the `backingFile` attribute:

```
<netuix:page definitionLabel="MyAppTableBook" title="My Page"
  markupName="page"
  markupType="Page"
  backingFile="com.bea.console.utils.NavTreeExtensionBacking"
>
```

The NavTreePortlet displays the value of the page element's `title` attribute as the link text. See [Figure 6–3](#).

If the `title` attribute value is a key in your message bundle, the NavTreePortlet displays the localized value mapped to the key. Specify a message bundle name by adding metadata to the page configuration. Add a `<netuix:meta>` element as a child to `<netuix:page>`, for example:

```
<netuix:page definitionLabel="MyAppTableBook" title="My Page">
  <netuix:meta name="skeleton-resource-bundle" content="3rdbundlename" />
  ...
</netuix:page>
```

**Figure 6–3 Append a Node to the Root of the Existing Tree**

## 6.4.2 Append or Insert Nodes or Node Trees

If you want to control the location in which your node is added to the NavTreePortlet, or if you want to add a node tree, implement your own `NavTreeExtensionBacking` backing class.

The following sections describe appending or inserting nodes or node trees:

- [Section 6.4.2.1, "Create a NavTreeBacking Class"](#)
- [Section 6.4.2.2, "Invoke the NavTreeBacking Class"](#)
- [Section 6.4.2.3, "Example: How a NavTreeExtensionBacking Class Adds a Node Tree to the NavTreePortlet"](#)

### 6.4.2.1 Create a NavTreeBacking Class

To create a `NavTreeBacking` class (see [Example 6–9](#)):

1. Extend `com.bea.console.utils.NavTreeExtensionBacking`.

This class is already available in the WebLogic Server runtime environment. However, for support in your development and compiling environment, you must add the following JARs to your environment's classpath:

```
WL_HOME/server/lib/consoleapp/webapp/WEB-INF/lib/console.jar
WL_HOME/server/lib/consoleapp/webapp/WEB-INF/lib/netuix_
servlet.jar
```

where `WL_HOME` is the location in which you installed WebLogic Server.

2. Override the `NavTreeExtensionBacking.getTreeExtension(`
3. `PageBackingContext ppCtx, String extensionUrl,`  
`HttpServletRequest request)` method.

In your implementation of this method:

- a. Construct a `com.bea.jsptools.tree.TreeNode` object for the parent node.

Use the following constructor:

```
TreeNode(String nodeId, String nodeName, String nodeUrl)
```

where:

`nodeId` is the value of the control's `definitionLabel`. You can use `PageBackingContext.getDefinitionLabel()` to get this value.



Alternatively, you can enter the `definitionLabel` value that is in the control's `.book` file.

`nodeName` is the text that you want to display in the NavTreePortlet. You can create a `String` object that contains the text or use `PageBackingContext.getTitle()` to get this value from the page's `.book` file.

`nodeURL` is a URL to the control. Supply `extensionUrl` as the value of this parameter.

- b. If you want to add a tree of nodes, construct additional `TreeNode` objects as children of the parent `TreeNode`.

For each child node, use the following constructor:

```
TreeNode(String nodeId, String nodeName,
         String nodeUrl, TreeNode parent)
```

where:

`nodeId` is the value of the control's `definitionLabel`. You can **not** use `PageBackingContext.getDefinitionLabel()` to get this value because the `PageBackingContext` available to this method is for the parent node. Instead, you must enter the `definitionLabel` value that is in the control's `.book` file.

`nodeName` is the text that you want to display in the NavTreePortlet.

`nodeURL` is a URL to the control. Supply the following value:

```
/console/console.portal?_nfpb=true&_pageLabel=definitionLabel
```

where `definitionLabel` is the `definitionLabel` of the page to which you want to link.

`parent` is any `TreeNode` that you have constructed. You can create multiple levels in your node tree by specifying a parent that is a child of node higher up in the hierarchy.

- c. Pass the parent `TreeNode` object to the constructor for `com.bea.console.utils.NavTreeExtensionEvent`.

Use the following constructor:

```
NavTreeExtensionEvent(String pageLabel, String url,
                    String parentPath, TreeNode node, int ACTION)
```

where:

`pageLabel` is the same `nodeID` value that you used when constructing the `TreeNode` object for the parent node.

`url` is the same `nodeURL` value that you used when constructing the `TreeNode` object for the parent node.

`parentPath` is the name of the node under which you want your node to display. Use / (slash) to represent the root of the navigation tree in the NavTreePortlet.

For example, if you want your node or node tree to display at the top level, specify /. If you want your node to display as a child of Environments, specify /Environments.

`node` is the parent `TreeNode` that you created in step a.

ACTION is `NavTreeExtensionEvent.APPEND_ACTION`. For information about other possible actions, see `NavTreeExtensionEvent` in the *WebLogic Server Administration Console API Reference*.

- d. Return the `NavTreeExtensionEvent` object that you constructed.
4. Save the compiled class in a package structure under your extension's `WEB-INF/classes` directory.

#### Example 6–9 Example `NavTreeExtensionBacking` Class

```
package com.mycompany.consoleext;
import com.bea.netuix.servlets.controls.page.PageBackingContext;
import com.bea.jsptools.tree.TreeNode;
import com.bea.console.utils.NavTreeExtensionBacking;
import com.bea.console.utils.NavTreeExtensionEvent;
public class CustomNavTreeExtension extends NavTreeExtensionBacking {
    public NavTreeExtensionEvent getTreeExtension(PageBackingContext ppCtx,
        String extensionUrl){
        /*
         * Construct a TreeNode for the control that has invoked this method.
         */
        TreeNode node = new TreeNode(ppCtx.getDefinitionLabel(),
            ppCtx.getTitle(), extensionUrl);
        /*
         * Construct a child TreeNode.
         */
        TreeNode node1 = new TreeNode("MyAppGeneralTabPage",
            "MyApp General",
            "/console/console.portal?_nfpb=true&_pageLabel=MyAppGeneralTabPage",
            node);
        /*
         * Add the parent node (which includes its child) below the
         * Environment node in the NavTreePortlet.
         */
        NavTreeExtensionEvent evt =
            new NavTreeExtensionEvent(ppCtx.getDefinitionLabel(), extensionUrl,
                "/Environment", node);
        return evt;
    }
}
```

#### 6.4.2.2 Invoke the `NavTreeBacking` Class

To invoke the `NavTreeBacking` class and start the process described in [Section 6.4.2.3, "Example: How a `NavTreeExtensionBacking` Class Adds a Node Tree to the `NavTreePortlet`"](#):

1. Determine which UI page control you want to add as the parent node.  
Only page controls can be added as nodes to the `NavTreePortlet`.
2. Add the following attribute and attribute value to the control's `netuix:page` element in the control's `.book` file:

```
backingFile="your-NavTreeBacking-class"
```

where *your-NavTreeBacking-class* is the fully-qualified name of the class you created in step 1.

### 6.4.2.3 Example: How a NavTreeExtensionBacking Class Adds a Node Tree to the NavTreePortlet

The following example describes how a `NavTreeExtensionBacking` class adds the node tree illustrated in [Figure 6-4](#):

1. As the portal framework loads your extension, it parses your extension's `.book` files and finds a `netuix:page` element.

For example:

```
<netuix:page definitionLabel="MyAppTabPage" title="My App"
  markupName="page"
  markupType="Page"
  backingFile="com.mycompany.utils.MyNavTreeExtension"
>
```

2. The portal framework instantiates a `com.bea.netuix.servlets.controls.page.PageBackingContext` object, which is an in-memory representation of the page UI control. The object contains properties that describe the page control's `title` and `definitionLabel` among other data.
3. When the portal framework encounters the `backingFile` attribute in the `netuix:page` element, it initializes the specified class (`MyNavTreeExtension`) and passes your page's `PageBackingContext` object to the class constructor. It also passes a `String` object that contains the page control's URI.
4. The `MyNavTreeExtension` class does the following:
  - a. It retrieves the `title` and `definitionLabel` values from the `PageBackingContext` object.
  - b. It constructs a `com.bea.jsptools.tree.TreeNode` object and passes the `title` and `definitionLabel` values along with the page control's URI to the constructor.
  - c. It constructs two additional `TreeNode` objects for two pages whose titles are "Monitor EJBs" and "Log Messages."

Because there is no way to retrieve the `PageBackingContext` objects or the URIs for these two pages, the values must be hard-coded in the `MyNavTreeExtension` class.

To make the pages into child nodes of the "My App" page node, the `MyNavTreeExtension` class uses a form of the `TreeNode` constructor that accepts the name of a parent node. For example:

```
TreeNode childnode1 = new TreeNode("MyAppMonitorEJB",
  "Monitor EJBs",
  "/console/console.portal?_nfpb=true&_pageLabel=MyAppMonitorEJB",
  node);
```

- d. It constructs and returns a `com.bea.console.utils.NavTreeExtensionEvent` object.
 

The `NavTreeExtensionEvent` object describes the `TreeNode` objects that you constructed and indicates the location in the existing navigation tree at which you want to append your node tree.
5. The `NavTreePortlet` listens for `NavTreeExtensionEvent` objects. As the portlet initializes its tree, it appends nodes as specified by any `NavTreeExtensionEvent` objects that are broadcast.

**Figure 6–4 Example: Adding a Node Tree to the NavTreePortlet**

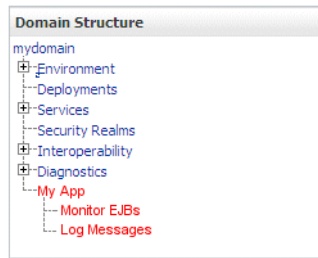

## 6.5 Navigating to a Custom Security Provider Page

If you created a custom security provider and used WebLogic MBeanMaker to create MBeans to manage your provider, the Administration Console automatically generates pages to display the provider's configuration data. It also generates a link to your provider pages from the Security: Providers table.

However, you can create your own pages to customize this display. If you create your own pages, you need to redirect the link in the Security: Providers table from the pages that the Administration Console generates to your custom pages.

To redirect the link, include the following element as a child of your page's `<netuix:page>` element:

```
<netuix:meta type="configuration" content="MBean-class-name" />
```

where *MBean-class-name* is the fully qualified name of your provider's MBean class.

For example:

```
<netuix:page markupName="page" markupType="Page"
  definitionLabel="SimpleSampleAuthorizerAuthorizerConfigCommonTabPage"
  title="tab.common.label"
  skeletonUri="/framework/skeletons/default/wlsworkspace
    /page_content.jsp">
  <netuix:meta name="configuration"
    content="examples.security.providers.authorization.simple.
      SimpleSampleAuthorizerMBean" />
  <netuix:content>
  ...
```

## Using Oracle Templates and JSP Tags

This chapter describes how to add a portlet that uses the Administration Console's JSP templates, styles, and user input controls.

For example, you can add portlets that render your content as one of the following:

- A table in the `ContentBook` that summarizes the resources you have provided and that enables users to navigate to a specific resource or to invoke actions on the resource from the table. (See [Figure 2-5](#) for an example of a WebLogic Server table.)
- A form in the `ContentBook` that enables users to monitor or configure resources that you have provided.

[Figure 7-1](#) illustrates the process. The steps in the process, and the results of each are described in [Table 7-1](#). Subsequent sections detail each step in the process.

**Figure 7-1 Administration Console Extension Development Overview**

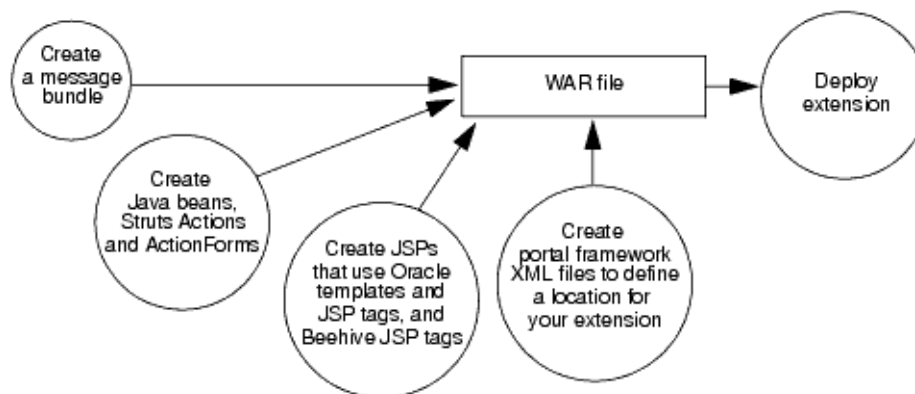

**Table 7-1 Model MBean Development Tasks and Results**

Step	Description	Result
1. <a href="#">Section 7.1, "Create and Use a Message Bundle in Your JSPs."</a>	Create a text file that contains a name/value pair for each text string that you want to display in your extension.	One or more <code>.properties</code> files.

**Table 7-1 (Cont.) Model MBean Development Tasks and Results**

Step	Description	Result
2. <a href="#">Section 7.3, "Create Struts Artifacts for Tables and Forms."</a>	The WebLogic Server JSP tags that render forms and tables assume that Apache Struts is the controller agent. The JSP tags use Java beans that are populated by Struts ActionForms (form beans) and submit user input to a Struts Action.	A Struts configuration file, Java beans, and Java classes that implement <code>org.apache.struts.action.ActionForm</code> and <code>org.apache.struts.action.Action</code> .
3. <a href="#">Section 7.4, "Create JSPs that Use Oracle Templates and JSP Tags."</a>	WebLogic Server provides JSP templates that you can import into your JSPs. It also provides a JSP tag library to render the same UI controls that the Administration Console uses.	JSPs that match the Administration Console styles and structure.
5. <a href="#">Section 7.5, "Create Other Portal Framework Files and Deploy the Extension."</a>	Create XML files that define a location for your extension.	A <code>.portlet</code> XML file that defines a portlet and configures it to launch a Struts Action.  A <code>.book</code> XML file that defines a page or book control (optional), a <code>netuix-extension.xml</code> file that describes where to locate your extension.
6. Archive and deploy the extension.	See <a href="#">Chapter 9, "Archiving and Deploying Console Extensions."</a>	A WAR file that contains your extension.

---



---

**Note:** You must precompile JSPs before deploying your extension.

---



---

## 7.1 Create and Use a Message Bundle in Your JSPs

Oracle recommends that you define all of the text strings that your JSPs display in a message bundle. For information about creating a message bundle, see [Chapter 4, "Creating a Message Bundle."](#)

To use the bundle in your JSPs:

1. Import the JSTL `fmt.tld` tag library:

```
<%@ taglib uri="http://java.sun.com/jsp/jstl/fmt" prefix="fmt" %>
```

2. Declare the name of your bundle:

```
<fmt:setBundle basename="bundle" var="current_bundle" scope="page"/>
```

where *bundle* is the name of your bundle.

3. When you want the JSP to output a string, use the following JSP tag:

```
<fmt:message key="property-name" bundle="${current_bundle}"/>
```

For example:

```
<fmt:message key="myextension.myTab.introduction" bundle="${current_bundle}"/>
```

## 7.2 Overview of Forms and Tables

WebLogic Server provides a `<wl:form>` JSP tag that can render a variety of HTML input controls, such as text controls, check boxes, and radio controls. You can configure a form to be read-only or to allow user input. Forms that allow user input must include buttons that enable users to post the form data for processing in the business layer.

WebLogic Server provides a `<wl:table>` JSP tag that renders data in a tabular format. Each row in the table represents a single entity such as a WebLogic Server instance, an application, or a log message (see [Figure 7-2](#)). You can configure table columns to render hypertext links, which enable users to navigate to pages that provide more information about an item in the table. You can also create a table column that contains an HTML check box control. If a user selects a check box for a table row and clicks a submit button, your extension can invoke business logic on behalf of the entire row. For example, you can use a check box to delete an item that a row represents.

Both of these tags use Apache Struts `Actions` and `ActionForms` to pass data between the business layer and the presentation layer.

### 7.2.1 Data Models for Forms and Tables

Apache Struts supports multiple techniques for instantiating and populating `ActionForm` beans (form beans). For example, you can code your own concrete Java bean that contains getter and setter methods for each property in the form. Or you can use the Struts `DynaActionForm` bean, which dynamically configures a Java bean to contain the properties that are declared in the Struts configuration file.

#### 7.2.1.1 Data Model for Forms

If you are using Oracle JSP tags to render a form in the Administration Console, you can use any technique for creating and populating form beans that Struts supports. (The example in [Section 2.4, "Example: How Struts Portlets Display Content"](#) uses a `DynaActionForm` bean instead of coding a custom Java bean.)

Regardless of the technique that you choose, your Java bean must contain the following property:

- `handle`, which can be of type `com.bea.console.handles.Handle` or a custom `Handle` class that you create.

The portal framework uses this property to correlate an `ActionForm` bean with the data source that populates the bean, such as an `MBean`. See [Section 7.2.2, "Handles for ActionForms and Row Beans."](#)

#### 7.2.1.2 Data Model for Tables

If you are using Oracle JSP tags to render a table in the Administration Console, you must create two form beans: one bean that represents the rows in the table (called a row bean) and another bean (called a table bean) that contains the collection of row beans. Each property in the row bean is rendered as a table column. For example, in [Figure 7-2](#), each row bean instance contains a `name`, `state`, `health`, and `listenPort` property.

**Figure 7–2 Row Beans and Table Bean**

	Name	Cluster	Machine	State	Health	Listen Port
Row bean, instance 1	AdminServer(admin)			RUNNING	OK	7001
Row bean, instance 2	BizAppServer		Machine-4647-0	UNKNOWN	OK	7001

To create a row bean, you must create a concrete Java bean that defines each property. You cannot use the Struts `DynaActionForm` bean to dynamically contain the properties that are declared in the Struts configuration file.

To create a table bean, you can use any technique for creating and populating form beans that Struts supports. Regardless of the technique that you choose, your table bean must contain the following properties:

- `content`, which must be of type `java.util.Collection`

This is the property that you must use to contain the row beans.

- `handle`, which can be of type `com.bea.console.handles.Handle` or a custom `Handle` class that you create.

While the portal framework requires you to declare this property for form beans and table beans, its usefulness is limited with table beans. Typically, a table bean is simply a collection of row beans; the row beans expose an underlying data source but the table bean does not. Unless you need to keep track of which `Action` class has populated your table bean, you do not need to set the value of this property of the table bean (but you must declare it). See [Section 7.2.2, "Handles for ActionForms and Row Beans."](#)

If you configure your table to include a column of check boxes, which enables you to invoke a Struts `Action` on the selected table row beans, your table bean must also contain the following property:

- `chosenContents`, which can be an array of any primitive type or an array of `com.bea.console.handles.Handle`. For information on how to work with check boxes in a table, see [Section 7.4.8, "Add Buttons and Check Boxes to Tables."](#)

## 7.2.2 Handles for ActionForms and Row Beans

To uniquely identify an instance of an `ActionForm` bean or a row bean and to establish a correlation between the bean and its underlying data source, you can create and use a `Handle` object. A `Handle` object is a Java object that implements the `com.bea.console.handles.Handle` interface.

The Apache Struts controller servlet places `Handle` objects in `HttpServletRequest` objects, thus making them available to any Struts `Action`, `Beehive Page Flow`, or `JSP`.

The Administration Console uses `Handle` objects when linking from a row in a table `JSP` (see [Figure 7–2](#)) to the corresponding configuration `JSP`. For example, for a `ServerMBean` instance named `Server-0`, the Administration Console populates row bean with data from the `Server-0` `MBean`. The Administration Console passes the `JMX` object name for `Server-0` to a new `Handle` object (of type `com.bea.console.handles.JMXHandle`) and sets the `Handle` object as the value of the row bean's `handle` property (see [Figure 7–3](#)). When a user clicks a link in the table `JSP`, the Struts controller looks in the row bean's `handle` property, uses the



handle value to determine which server instance has been selected, and displays the configuration page for the selected server.

**Figure 7–3 JMXHandle in a Row Bean**

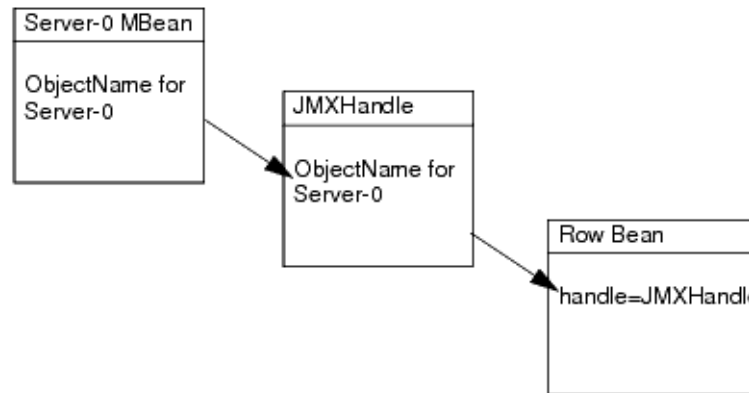

If the underlying data source for your `ActionForm` beans or row beans is an `MBean`, you can use the `com.bea.console.handles.JMXHandle` object. See `JMXHandle` in the *Administration Console API Reference*.

If the underlying data source for your beans is not an `MBean`, you can create your own Java class that implements the `com.bea.console.handles.Handle` interface. See `Handle` in the *Administration Console API Reference*.

## 7.3 Create Struts Artifacts for Tables and Forms

To render HTML forms and tables and populate them with data, the Administration Console uses JSP tags that load data from Java beans. Most of these beans contain data that a Struts `Action` has loaded from a WebLogic Server `MBean`. To submit user input, the JSP tags forward to Struts `Actions`, and most of these `Actions` update data in a WebLogic Server `MBean`.

If you use Administration Console JSP tags, you must create your own Struts `ActionForms` and `Actions`.

The following sections describe creating Java beans, Struts `Actions`, and `ActionForms` to use with forms and tables:

- [Section 7.3.1, "Create Struts Artifacts for a Form JSP: Main Steps"](#)
- [Section 7.3.2, "Create Struts Artifacts for a Table JSP"](#)

For information on Apache Struts, see *The Apache Struts Web Application Framework* at <http://struts.apache.org/>.

### 7.3.1 Create Struts Artifacts for a Form JSP: Main Steps

To create Struts artifacts that pass data between the business layer and a JSP in the presentation layer:

1. Create an `org.apache.struts.action.Action` class that populates a Java bean (form bean) with data from your business layer.

If your form allows user input, create another `Action` class to process the data that users post from the form.

See [Section 7.3.1.1, "Create Struts Action Classes for Handling Form Data."](#)

2. In your Struts configuration file:
  - a. Declare the name and the properties of the form bean that your `Action` classes will populate and use.  
If your form allows user input, you can use the same form bean to populate the form and to return user input to your `Action` class that processes data.
  - b. Create an `Action` mapping that the Struts controller uses to instantiate your form bean and invoke your `Action` class that populates the form.  
If your form allows user input, create another `Action` mapping that the Struts controller uses when users submit the form.  
See [Section 7.3.1.2, "Configure Struts ActionForms and Action Mappings."](#)

### 7.3.1.1 Create Struts Action Classes for Handling Form Data

To create Struts `Action` classes that handle form data:

1. Create an `org.apache.struts.action.Action` class that populates the form bean. (See [Example 7-1.](#))

The Struts controller passes an empty `ActionForm` bean to your `Action` class. To populate the bean, implement the following method:

```
Action.execute(ActionMapping actionMapping,
              ActionForm actionForm,
              HttpServletRequest httpServletRequest,
              HttpServletResponse httpServletResponse)
```

Your implementation should:

- a. Gather data from an underlying source, such as an `MBean`.
- b. Cast the empty `ActionForm` bean as a `DynaActionForm` bean.
- c. Invoke the `DynaActionForm.set()` method for each property that you defined in the `<form-bean>` element, except for the `handle` property.

For example, if you defined two properties named `name` and `totalRx`:

```
DynaActionForm form = (DynaActionForm) actionForm;
form.set("name", nameFromMBean);
form.set("totalRx", totalRxFromMBean);
```

- d. To establish a correlation between the form bean and its underlying data source, set the value of the `handle` property. (See [Section 7.2.2, "Handles for ActionForms and Row Beans."](#))

For example, if your underlying data source is an `MBean`, use `JMXHandle` and set the `handle` property to the `MBean`'s `ObjectName`:

```
ObjectName anMBean = new
    ObjectName("com.bea.medrec:Type=com.bea.medrec.controller.
              RecordSessionEJBMBean,Name=MedRecEAR");
form.setHandle(new JMXHandle(anMBean));
```

- e. Put the `DynaActionForm` bean into the request object that was also passed to the class:

```
httpServletRequest.setAttribute("form-bean-name", form);
```

where *form-bean-name* matches the name that you configure for the form bean in the Struts configuration file (see [Section 7.3.1.2, "Configure Struts ActionForms and Action Mappings"](#)).

- f. Return "success" in the `ActionMapping.findForward()` method for the `ActionMapping` object that was passed to the `Action` class:
  - g. `return actionMapping.findForward("success");`
2. If your form posts data for processing in the business layer, create another `Action` class that processes the form data.

When a user posts data from the form (by clicking an HTML button), the Struts controller passes a populated `ActionForm` bean to your `Action` class. To process the data, implement the following method:

```
Action.execute(ActionMapping actionMapping,
               ActionForm actionForm,
               HttpServletRequest httpServletRequest,
               HttpServletResponse httpServletResponse)
```

Your implementation should:

- a. Cast the `ActionForm` bean that was passed in the request as a `DynaActionForm` bean.
- b. Invoke the `DynaActionForm.get()` method for each property that you want to process.

For example, if you want to process the properties named `name`, `totalRx`, and `handle`:

```
DynaActionForm form = (DynaActionForm) actionForm;
String nameValue = (String) form.get(nameFromMBean);
Integer totalValue = (Integer) form.get(totalRxfromMBean);
JMXHandle handle = (JMXHandle) form.get(handle);
```

- c. Process the data.

For example, if the `name` and `totalRx` properties represent attributes in a `MBean` and you want to change the values of the `MBean` attributes, use the `handle` property to get the JMX object name of the `MBean` instance, and then use JMX APIs to set the `MBean` attributes to the values that were posted from the form:

```
ObjectName oName = handle.getObjectNames();
MBeanServer.setAttribute(oName, new Attribute("Name", nameValue));
MBeanServer.setAttribute(oName, new Attribute("TotalRx", totalValue));
```

- d. Return "success" in the `ActionMapping.findForward()` method for the `ActionMapping` object that was passed to the `Action` class:
 

```
return actionMapping.findForward("success");
```
3. Compile the `Action` classes and save them in a package structure that begins in the `root-dir/WEB-INF/classes` directory.

[Example 7-1](#) is an example `org.apache.struts.action.Action` class that accesses a custom `MBean` and uses it to populate a form bean.

#### **Example 7-1 Example: Action Class that Populates a Form Bean**

```
import javax.management.MBeanServer;
import javax.management.ObjectName;
import javax.management.MalformedObjectNameException;
```

```

import javax.naming.InitialContext;
import javax.servlet.http.HttpServletRequest;
import javax.servlet.http.HttpServletResponse;
import org.apache.struts.action.DynaActionForm;
import org.apache.struts.action.Action;
import org.apache.struts.action.ActionForm;
import org.apache.struts.action.ActionForward;
import org.apache.struts.action.ActionMapping;
public class MedRecMBeanFormAction extends Action {
    public ActionForward execute(ActionMapping actionMapping,
                                ActionForm actionForm,
                                HttpServletRequest httpRequest,
                                HttpServletResponse httpResponse)
        throws Exception {
    try {
        // Establish a local connection to the Runtime MBean Server
        InitialContext ctx = new InitialContext();
        MBeanServer server =
            (MBeanServer) ctx.lookup("java:comp/env/jmx/runtime");
        // Create an ObjectName that corresponds to a custom MBean that
        // has been registered in the Runtime MBean Server
        ObjectName anMBean = new ObjectName(
            "com.bea.medrec:Type=com.bea.medrec.controller.
            RecordSessionEJBMBEAN,Name=MedRecEAR");
        //Get the value of the custom MBean's "Name" attribute
        String namefromMBean = (String)server.getAttribute
            (anMBean, "Name");
        // Get the value of the custom MBean's "TotalRx" attribute
        Integer totalRxfromMBean = (Integer) server.getAttribute
            (anMBean, "TotalRx");
        // Populate the form bean
        DynaActionForm form = (DynaActionForm) actionForm;
        form.set("name",namefromMBean);
        form.set("totalRx",totalRxfromMBean);
        form.set("handle", (new JMXHandle(anMBean)));
        // Set the form bean in request. The name of the
        // form bean must match the "form-bean" name in your
        // Struts configuration file
        httpRequest.setAttribute("medrecMBeanEJBForm", form);
    } catch (Exception ex) {
        ex.printStackTrace();
    }
    return actionMapping.findForward("success");
}
}

```

### 7.3.1.2 Configure Struts ActionForms and Action Mappings

To create a Struts configuration file that declares your `ActionForms` and `Action` mappings:

1. Copy the code from [Example 7-2](#) and paste it into the configuration file for your Struts module.

If you have not already created a configuration file, create a text file in `root-dir/WEB-INF` (see [Section 3.3, "Create a Directory Tree for the Extension"](#)). Name the file `struts-auto-config-module.xml`.

where `module` is a name that you have chosen for your Struts module. Consider using the name of your company to avoid possible naming conflicts. You must create your own Struts module; the default Struts module is reserved for Oracle

Actions and ActionForms. For information about Struts modules, see the Apache Struts *User Guide* at <http://struts.apache.org/struts-doc-1.2.x/userGuide/index.html>.

2. To configure a form bean that Struts will use to transfer data from the business layer to the JSP in the presentation layer, replace the following value in [Example 7-2](#):
  - *form-bean-name*, a unique name that you assign to this instance of a `DynaActionForm` bean. Your `Action` class will refer to this bean name when it populates the bean and returns it to the Struts controller.

Use a name that reflects the name of the Struts `Action` that you will use to populate the bean instance.

3. To configure an `Action` mapping that Struts will use to populate the form bean, serialize the bean, put it into an HTTP request, and forward the request to a JSP, replace the following values in [Example 7-2](#):
  - *action-name*, a unique name that you assign to this `Action` mapping. Your `.portlet` file will refer to this `Action` name.
  - *custom-Action-class*, the fully qualified name of a Java class that you create to populate the form bean. Step 5 describes how to create this class.
  - *form-jsp.jsp*, the name of a JSP that you create to render the form. See [Section 7.4.2, "Create a Form JSP."](#)
4. If your form posts data for processing in the business layer, create another `<action>` element that specifies a custom class that you will create to process the form data.

For *form-bean-name* of this second `<action>` element, you can use the same form bean that initially populated the form. If you want to post only a subset of the data for processing, instead of using the same form bean you can configure another one that defines only the properties that you want to process.

Upon success, this additional `<action>` element can forward to the `Action` mapping that you configured in the previous step. This reloads the JSP with the updated data.

#### **Example 7-2 Template for Struts Configuration File**

```
<?xml version="1.0" encoding="ISO-8859-1" ?>
<!DOCTYPE struts-config PUBLIC
  "-//Apache Software Foundation//DTD Struts Configuration 1.1//EN"
  "struts-config_1_1.dtd">
<struts-config>
  <form-beans>
    <form-bean name="form-bean-name"
      type="org.apache.struts.action.DynaActionForm">
      <form-property name="handle" type="com.bea.console.handle.Handle"/>
      <!-- insert additional "form-property" elements here -->
    </form-bean>
  </form-beans>
  <action-mappings>
    <action path="/action-name"
      type="custom-Action-class"
      name="form-bean-name"
      scope="request"
      validate="false">
```

```

        <forward name="success" contextRelative="true"
            path="/ext_jsp/form-jsp.jsp" />
    </action>
    <!-- insert additional "action" elements here -->
</action-mappings>
<message-resources parameter="global" />
<message-resources parameter="validationmessages" key="VALIDATIONMESSAGES" />
<message-resources parameter="genresources" key="GENRESOURCES" />
<message-resources parameter="global" key="GLOBAL" />
</struts-config>

```

## 7.3.2 Create Struts Artifacts for a Table JSP

To create a Java row bean, Struts Action, and ActionForm for a JSP that uses the WebLogic Server `<wl:table>` JSP tag:

1. To configure a bean that will function as the row bean, create a standard Java bean that contains one property for each data item that you want to display in the table.

Compile your Java bean and save it in a package structure that begins in the `root-dir/WEB-INF/classes` directory.

2. To configure a bean that will function as the table bean:

- a. Copy the code from [Example 7-2](#) and paste it into the configuration file for your Struts module.

If you have not already created a configuration file, create a text file in `root-dir/WEB-INF` (see [Section 3.3, "Create a Directory Tree for the Extension"](#)). Name the file `struts-auto-config-module.xml`

where *module* is a name that you have chosen for your Struts module. Consider using the name of your company to avoid possible naming conflicts. You must create your own Struts module; the default Struts module is reserved for Oracle Actions and ActionForms. For information about Struts modules, see the *Apache Struts User Guide* at <http://struts.apache.org/userGuide/index.html>.

- b. Replace the following value in [Example 7-2](#):

*form-bean-name*, a unique name that you assign to this instance of a DynaActionForm bean. Your Action class will refer to this bean name when it populates the bean and returns it to the Struts controller.

Use a name that reflects the name of the Struts Action that you will use to populate the bean instance.

- c. Add the following property:

```
<form-property name="contents" type="java.util.Collection"/>
```

This property will contain the collection of row beans that your Action class instantiates and populates.

3. To configure an Action mapping that Struts will use to populate the row beans and the table bean, serialize the beans, put them into an HTTP request, and forward the request to a JSP, replace the following values in [Example 7-2](#):
  - *action-name*, a unique name that you assign to this Action mapping. Your `.portlet` file will refer to this Action name.
  - *custom-Action-class*, the fully qualified name of a Java class that you create to populate the row beans and table bean. Step 5 describes how to create this class.

- *form-jsp.jsp*, the name of a JSP that you create to render the table. See [Section 7.4.2, "Create a Form JSP."](#)
4. Create an `org.apache.struts.action.Action` class that populates the row beans and table bean. (See [Example 7-3](#).)

To populate the beans, implement the following method:

```
Action.execute(ActionMapping actionMapping,
               ActionForm actionForm,
               HttpServletRequest httpServletRequest,
               HttpServletResponse httpServletResponse)
```

Your implementation should:

- a. Gather application data from underlying data sources, such as instances of an MBean.
- b. Create instances of your row bean and populate them by invoking their setters for each property in the bean.
- c. Assign all of your row bean instances to an `ArrayList`.
- d. Cast the empty `ActionForm` bean (table bean) as a `DynaActionForm` bean.
- e. Set the table bean's content property to contain the `ArrayList` of row beans:

```
DynaActionForm table = (DynaActionForm) actionForm;
table.set("contents", rowBeanArray);
```

- f. Put the table bean into the request object that was also passed to the class:

```
httpServletRequest.setAttribute("table-bean-name", table);
```

where *table-bean-name* is the name that you configured for the table bean in the Struts configuration file (see [Example 7-2](#)).

- g. Return "success" in the `ActionMapping.findForward()` method for the `ActionMapping` object that was passed to the `Action` class:
  - h. `return actionMapping.findForward("success");`
5. Compile the `Action` class and save it in a package structure that begins in the *root-dir/WEB-INF/classes* directory.

**Example 7-3 Example: Action Class that Populates a Row Bean and a Table Bean**

```
import java.util.ArrayList;
import java.util.Collection;
import java.util.Iterator;
import java.util.Set;
import javax.management.MBeanServer;
import javax.management.ObjectName;
import javax.management.MalformedObjectNameException;
import javax.naming.InitialContext;
import javax.servlet.http.HttpServletRequest;
import javax.servlet.http.HttpServletResponse;
import org.apache.struts.action.DynaActionForm;
import org.apache.struts.action.Action;
import org.apache.struts.action.ActionForm;
import org.apache.struts.action.ActionForward;
import org.apache.struts.action.ActionMapping;
public class RetrieveCustomMBeansAction extends Action {
```

```
public ActionForward execute(ActionMapping actionMapping,
                            ActionForm actionForm,
                            HttpServletRequest httpServletRequest,
                            HttpServletResponse httpServletResponse)
    throws Exception {
    try {
        // Establish a local connection to the Runtime MBean Server
        InitialContext ctx = new InitialContext();
        MBeanServer server =
            (MBeanServer) ctx.lookup("java:comp/env/jmx/runtime");
        // Create a name pattern for all MedRec EJB MBeans
        ObjectName namepattern = new
            ObjectName("com.bea.medrec:Type=com.bea.medrec.controller.
                RecordSessionEJBMBBean,*");
        // Get all MedRec EJB MBeans for all applications
        Set objects = server.queryNames(namepattern, null);
        // Walk through each of these MBeans and get the object name
        // and the value of its TotalRX attribute
        Iterator i = objects.iterator();
        while (i.hasNext()) {
            ObjectName anMBean = (ObjectName) i.next();
            String identifier = anMBean.toString();
            Integer totalRxfromMBean =
                (Integer) server.getAttribute(anMBean, "TotalRx");
            // Instantiate a row bean.
            MedRecMBeanTableBean row = new MedRecMBeanTableBean(anMBean);
            // Set the properties of the row bean
            row.setCanonicalName(anMBean.getCanonicalName());
            row.setTotalRxinTableBean(totalRxfromMBean);
            // Add each row bean to an ArrayList
            result.add(row);
        }
    } catch (Exception ex) {
        ex.printStackTrace();
    }
    // Instantiate the table bean
    DynaActionForm form = (DynaActionForm) actionForm;
    // Set the array of row beans as the value of the table bean's "contents"
    // property
    form.set("contents",result);
    // Set the table bean in request. The name of the
    // table bean must match the "form-bean" name in your
    // Struts configuration file
    httpServletRequest.setAttribute("genericTableForm", form);
    return actionMapping.findForward("success");
}
}
```

## 7.4 Create JSPs that Use Oracle Templates and JSP Tags

Most portlets in the Administration Console JSPs that are based on the `tableBaseLayout_netui` and `configBaseLayout_netui` templates.

The following sections describe how to create JSPs that use these templates:

- [Section 7.4.1, "WebLogic Server JSP Templates"](#)
- [Section 7.4.2, "Create a Form JSP"](#)
- [Section 7.4.3, "Create a Table JSP for Monitoring"](#)



- [Section 7.4.4, "Create a Table Column for Navigating to Other Pages"](#)
- [Section 7.4.8, "Add Buttons and Check Boxes to Tables"](#)
- [Section 7.4.9, "Configure Table Preferences"](#)

## 7.4.1 WebLogic Server JSP Templates

Table 7–2 describes the JSP templates that you can use for your Administration Console extensions. All of the templates are located in the `/layouts` directory, which is relative to the `WEB-INF` directory of the Administration Console. For more specific information about what a template does, open the JSP file and read the comment toward the beginning of the file.

If these templates do not meet your needs, you can create your own templates and structure the content directly in your JSP.

**Table 7–2 Administration Console JSP Templates**

Template	Use for...
<code>assistantBaseLayout_netui.jsp</code>	All standard assistant JSPs in the console.
<code>assistantFormAndTableLayout_netui.jsp</code>	All standard assistant JSPs in the console containing a table.
<code>configBaseLayout_netui.jsp</code>	All standard configuration form JSPs in the console.
<code>configBaseLayoutNoTransact.jsp</code>	All non-transaction configuration form JSPs in the console
<code>configBaseLayoutWithButtons_netui.jsp</code>	All standard configuration form JPs in the console with extra buttons in the button bar.
<code>configIntroLayout_netui.jsp</code>	Simple pages with text only.
<code>configNoFieldsLayout_netui.jsp</code>	All information pages.
<code>configNoTransactAndTables_netui.jsp</code>	Pages that contain non-transactional configuration and up to four tables.
<code>filterAndTableLayout_netui.jsp</code>	All pages that have a table with filters above it.
<code>formAndTableLayout_netui.jsp</code>	Configuration form JSPs that also contain a table.
<code>formWithButtonsLayout_netui.jsp</code>	Form pages with a button bar; but they do not participate in Configuration Manager locking.
<code>fourTablesLayout_netui.jsp</code>	All table pages with four tables.
<code>standalone_layout.jsp</code>	Standalone pages, that is, pages outside the console Portal.
<code>summarypage.jsp</code>	All summary pages.
<code>tableBaseLayout_netui.jsp</code>	The Administration Console uses this template for all JSPs that render a single table.
<code>tableBaseMonitoringLayout.jsp</code>	All single table pages that include table refresh functionality.
<code>tablePreferencesLayout.jsp</code>	Deprecated.
<code>threeTablesLayout_netui.jsp</code>	All table pages with three tables.
<code>twoTablesLayout_netui.jsp</code>	All table pages with two tables.
<code>twoTablesWithButtonsLayout.jsp</code>	Pages with two tables and a button bar.

## 7.4.2 Create a Form JSP

Before you create a form JSP, create Struts artifacts that pass data between the business layer and the JSP. See [Section 7.3.1, "Create Struts Artifacts for a Form JSP: Main Steps."](#)

To create a form JSP (see [Example 7-4](#)):

1. Create a JSP and save it in your development directory. Consider creating a subdirectory to contain all of the JSPs in your extension. For example, *root-dir/jsp*, where *root-dir* is your development directory. For more information, see [Chapter 3, "Setting Up a Development Environment."](#)
2. Import JSP tag libraries by including the following tags:
  - `<%@ taglib uri="/WEB-INF/console-html.tld" prefix="wl-extension" %>`
  - `<%@ taglib uri="http://struts.apache.org/tags-html" prefix="html" %>`
  - `<%@ taglib uri="http://java.sun.com/jsp/jstl/fmt" prefix="fmt" %>`
  - `<%@ taglib uri="http://beehive.apache.org/netui/tags-template-1.0" prefix="beehive-template" %>`

For information about these tag libraries, see [Section 2.3.1, "JSP Tag Libraries."](#)

3. (Optional) If you plan to use `<fmt:message>` tags to display localized text, use `<fmt:setBundle/>` to specify the name of the message bundle.

This `<fmt:setBundle/>` tag enables you to specify the bundle name once, and then refer to this value from `<fmt:message>` tags by variable.

4. Declare the JSP template for configuration pages by creating the following opening tag:

```
<beehive-template:template
templatePage="/layouts/configBaseLayoutNoTransact.jsp">
```

Do not close the tag yet. All other JSP tags in a form JSP are nested in this template tag.

---



---

**Note:** If your form modifies attributes of WebLogic Server MBeans, use the `configBaseLayout_netui.jsp` template instead. See [Section 2.3.1, "JSP Tag Libraries."](#)

---



---

5. Create a `<beehive-template:section name="configAreaIntroduction">` tag. Inside this tag, provide an introductory sentence or paragraph that describes the form. This description is rendered above the form.
6. Create the following opening tag:
7. `<beehive-template:section name="form">`  
Do not close the tag yet.
8. Indicate that the next set of JSP tags output XHTML by creating the following tag:  
`<html:xhtml/>`

9. Create an opening `<wl-extension:template name="/WEB-INF/templates/form.xml">` tag.

This template creates a form that matches Administration Console configuration pages (such as Domains: Configuration: General).

The template also generates a button that submits the form.

10. Create an opening `<wl-extension:form>` and specify values for the following attributes:
  - `action`, (optional) if your form accepts user input, specify the path of a Struts Action that is invoked when a user submits this form. The Struts module that defines the Action path is specified in the request.
  - `bundle`, (optional) specify the name of a message bundle that contains localized names of your column headings.
  - `readOnly`, (optional) specify "true" to make this form read-only (for example, if you are displaying read-only monitoring data).
11. For each property in the form bean that you want to display in the form, create a `<wl-extension>` tag corresponding to the type of control that you want to render (see WebLogic Server JSP Tags Reference):
  - `<wl-extension:checkbox>`
  - `<wl-extension:chooser-tag>`
  - `<wl-extension:hidden>`
  - `<wl-extension:password>`
  - `<wl-extension:radio>`
  - `<wl-extension:select>`
  - `<wl-extension:text>`
  - `<wl-extension:text-area>`

Alternatively, you can use `<wl-extension:reflecting-fields>`, which generates an HTML input tag for each property in a form bean. For example, for a bean property that contains a `java.lang.String`, the tag generates a text control; for a boolean, it generates a check box. This tag uses the default form bean, which is passed to the JSP in the request.

12. If your form accepts user input and does not modify the attributes of WebLogic Server MBeans, be sure to include the `singlechange="false"` attribute in the `<wl-extension>` tags described in the previous step.
 

This attribute enables users to post form data without starting a WebLogic Server edit session.
13. To generate text on the page that describes to users the purpose of each control, include the `inlineHelpId` attribute in each `<wl-extension>` tag in the previous step.
14. Close the `<wl-extension:form>`, `<beehive-template:section>`, and `<beehive-template:template>` tags.

#### **Example 7-4 Example: Simple Form JSP**

```
<%@ page language="java" %>
<%@ taglib uri="/WEB-INF/console-html.tld" prefix="wl-extension" %>
```

```
<%@ taglib uri="http://struts.apache.org/tags-html" prefix="html" %>
<%@ taglib uri="http://java.sun.com/jsp/jstl/fmt" prefix="fmt" %>
<%@ taglib uri="http://beehive.apache.org/netui/tags-template-1.0" prefix="beehive-template" %>
<fmt:setBundle basename="mycompany" var="current_bundle" scope="page"/>
<beehive-template:template templatePage="/layouts/configBaseLayoutNoTransact.jsp">
  <beehive-template:section name="configAreaIntroduction">
    <fmt:message key="mycompany.myresource.introduction"
      bundle="{current_bundle}"/>
  </beehive-template:section>
  <beehive-template:section name="form">
    <html:xhtml/>
    <wl-extension:template name="/WEB-INF/templates/form.xml">
      <wl-extension:form action="/MyCompanyMyResourceUpdated" bundle="core">
        <wl-extension:text property="MyResourceName"
          labelId="mycompany.myresource.name.label"
          inlineHelpId="mycompany.myresource.name.label.inlinehelp"
          singlechange="false"/>
        <wl-extension:select
          property="MyResourceWidgets"
          labelId="mycompany.myresource.widgets.label"
          inlineHelpId="mycompany.myresource.widgets.label.inlinehelp"
          singlechange="false">
          <wl-extension:optionsCollection
            property="MyResourceAvailableWidgets"
            label="label" value="value"/>
        </wl-extension:select>
      </wl-extension:form>
    </wl-extension:template>
  </beehive-template:section>
</beehive-template:template>
```

### 7.4.3 Create a Table JSP for Monitoring

Before you create a table JSP, create Struts artifacts that pass data between the business layer and the JSP. See [Section 7.3.2, "Create Struts Artifacts for a Table JSP."](#)

To create a table JSP for monitoring resources (see [Example 7-5](#)):

1. Create a JSP and save it in your development directory. Consider creating a subdirectory to contain all of the JSPs in your extension. For example, *root-dir/ext\_jsp*, where *root-dir* is your development directory.

---

---

**Note:** The directory named *root-dir/jsp* is reserved. The root directory of your extension must not contain a directory named *jsp*.

---

---

For more information, see [Chapter 3, "Setting Up a Development Environment."](#)

2. Import JSP tag libraries by including the following tags:

```
<%@ taglib uri="/WEB-INF/console-html.tld" prefix="wl-extension" %>
<%@ taglib uri="http://struts.apache.org/tags-html" prefix="html" %>
<%@ taglib uri="http://java.sun.com/jsp/jstl/fmt" prefix="fmt" %>
<%@ taglib uri="http://beehive.apache.org/netui/tags-template-1.0"
  prefix="beehive-template" %>
```

For information about these tag libraries, see [Section 2.3.1, "JSP Tag Libraries."](#)

3. (Optional) If you plan to use `<fmt:message>` tags to display localized text, use `<fmt:setBundle/>` to specify the name of the message bundle.

This `<fmt:setBundle/>` tag enables you to specify the bundle name once, and then refer to this value from `<fmt:message>` tags by variable.

4. Declare the JSP template for tables by creating the following opening tag:

```
<beehive-template:template
  templatePage="/layouts/tableBaseLayout_netui.jsp">
```

Do not close the tag yet. All other JSP tags in a table JSP are nested in this template tag.

5. Create a `<beehive-template:section name="configAreaIntroduction">` tag. Inside this tag, provide an introductory sentence or paragraph that describes the table. This description is rendered above the table.

6. Create the following opening tag:

```
<beehive-template:section name="table">
```

Do not close the tag yet.

7. Create an opening `<wl-extensions:table>` tag and specify values for the following minimal attributes:

- `name`, specify the name of the form bean that you configured for this table.
- `property`, specify the name of the form-bean property that contains row beans.
- `bundle`, (optional) specify the name of a message bundle that contains localized names of your column headings.
- `captionEnabled`, (optional) specify "true" to generate a title above the table.

8. If you specified "true" for the `captionEnabled` attribute, create a `<wl-extension:caption>` tag. Inside this tag, provide a caption for the table.

9. For each property in the row bean that you want to display in the table, create a `<wl-extension:column>` tag and specify values for the following attributes:

- `property`, specify the name of the row bean property
- `label`, specify a key in your message bundle to display as the column heading

10. Close the `<wl-extension:table>`, `<beehive-template:section>`, and `<beehive-template:template>` tags.

### **Example 7-5 Example: Table JSP for Monitoring**

```
<%@ page language="java" %>
<%@ taglib uri="/WEB-INF/console-html.tld" prefix="wl-extension" %>
<%@ taglib uri="http://struts.apache.org/tags-html" prefix="html" %>
<%@ taglib uri="http://java.sun.com/jsp/jstl/fmt" prefix="fmt" %>
<%@ taglib uri="http://beehive.apache.org/netui/tags-template-1.0" prefix="beehive-template" %>
<fmt:setBundle basename="core" var="current_bundle" scope="page"/>
<beehive-template:template templatePage="/layouts/tableBaseLayout_netui.jsp">
  <beehive-template:section name="configAreaIntroduction">
    <fmt:message key="core.server.servertable.introduction"
      bundle="{current_bundle}"/>
  </beehive-template:section>
```

```
<beehive-template:section name="table">
  <wl-extension:table name="extensionForm"
    property="contents"
    captionEnabled="true"
    bundle="core">
    <wl-extension:caption>
      <fmt:message key="server.table.caption"
        bundle="{current_bundle}" />
    </wl-extension:caption>
    <wl-extension:column property="name"
      label="server.table.label.name" />
    <wl-extension:column property="clusterName"
      label="server.table.label.cluster" />
    <wl-extension:column property="machineName"
      label="server.table.label.machine" />
  </wl-extension:table>
</beehive-template:section>
</beehive-template:template>
```

## 7.4.4 Create a Table Column for Navigating to Other Pages

Your table JSP can provide a link from each row to a configuration page or some other related page. The linking mechanism uses a `Handle` object to determine which pages are related to a specific table row (see [Section 7.2.2, "Handles for ActionForms and Row Beans"](#)).

You can use any of the following JSP tags to link from a table:

- `<wl:column-link>`, which requires you to specify the label of the page and portlet instance to which you want to link. The `handle` causes the portlet to display data related to the specific row that you selected.
- `<wl:column-dispatch>`, which uses metadata to determine the page and portlet to display. Instead of specifying the page and portlet label, you add a metadata tag to the page declaration and then specify the metadata value in the `<wl:column-dispatch>` tag. Using metadata enables you to change page labels without breaking links. The `handle` is still used to cause the portlet in the page to display data related to the specific row that you selected.

The following sections describe how to create a table column for navigating:

- [Section 7.4.5, "Add a Handle to Your Row Bean and Action Class"](#)
- [Section 7.4.6, "Use the column-link Tag"](#)
- [Section 7.4.7, "Use the column-dispatch Tag"](#)

## 7.4.5 Add a Handle to Your Row Bean and Action Class

To create and populate a `handle` property:

1. In your row bean, add a property named `handle` whose data type is `com.bea.console.handles.Handle`:

```
public com.bea.console.handles.Handle getHandle() {
    return handle;
}
public void setHandle(Handle handle) {
    this.handle = handle;
}
```

2. In the `Struts Action` class that populates the row bean, set the value of the `handle` property.

If you populate your row bean from data in an MBean, create a `com.bea.console.handles.JMXHandle` object that contains the `JMXObjectName` of the MBean. Then set the `JMXHandle` object as the value of the `handle` property:

```
javax.management.ObjectName anMBean = new
    ObjectName("com.bea.medrec:Type=com.bea.medrec.controller.
        RecordSessionEJBMBean,Name=MedRecEAR");
row.setHandle(new JMXHandle(anMBean));
```

If you populate your row bean from some other type of data source, you can create a `JMXHandle` object by passing a `String` to the constructor instead of an `ObjectName`. The `String` must contain the following character sequence: `Type=identifier`, where `identifier` is something that is meaningful to you:

```
row.setHandle(new JMXHandle("Type=myDataSource"));
```

You can also create and set a custom `Handle` object. See `Handle` in the *Administration Console API Reference*.

3. Recompile your row bean and `Action` class.

## 7.4.6 Use the column-link Tag

To use the `<wl:column-link>` tag:

1. At the top of the table JSP, add the following statement to import the render tag library into your table JSP:

```
<%@ taglib uri="render.tld" prefix="render" %>
```

Oracle provides this tag library in its runtime environment.

2. In the `<wl:table>` tag, add the following attribute:

```
checkBoxValue="handle"
```

3. In the `<wl:column>` tag that renders the column from which you want to link, nest the `<wl:column-link>` JSP tag:

```
<wl:column-link portlet="portlet-instanceLabel">
    <render:pageUrl pageLabel="page-definitionLabel"/>
</wl:column-link>
```

where:

- `portlet-instanceLabel` is the label of the portlet instance to which you want to link.

The label is defined in the `instanceLabel` attribute of the `<netuix:portletInstance>` element, which is in the `.book` file for the page that contains the portlet.

- `page-definitionLabel` is the unique label of the page that contains the instance of the portlet to which you want to link.

The label is defined in the `definitionLabel` attribute of the `<netuix:page>` element, which is in the page's `.book` file.

For example:

```

<wl:column property="Name"
  label="medrecMBean.name.label">
  <wl:column-link portlet="medrecMonitorTabPortlet">
    <render:pageUrl pageLabel="medrecMonitor" />
  </wl:column-link>
</wl:column>

```

---

**Note:** The `<render:pageUrl />` tag is a convenience tag for generating a portal framework URL.

---

## 7.4.7 Use the column-dispatch Tag

To use the `<wl:column-dispatch>` tag:

1. In the `.book` file that defines the page to which you want to link, find the page's `<netuix:page>` element and nest the following element:

```
<netuix:meta name="perspective-name" content="ObjectType-value" />
```

where:

- `perspective-name` is a name that is meaningful to you. This value must match the value that you specify in the `perspective` attribute of the `<wl:column-dispatch>` tag. For example, specify `myCompany-configuration-page`.
- `ObjectType-value` is the value of the `ObjectType` property in the row bean's `Handle` object. See `Handle.getObjectType()` in the *Administration Console API Reference*.

For example, assume that you populate your row bean from data in an MBean. You use the MBean's `ObjectName` to construct a `JMXHandle` object and then set the object as the value of the row bean's `handle` property. If the MBean's `ObjectName` is `"com.mycompany:Name=myApp1, Type=myAppMBean"`, then the value of `JMXHandle.ObjectType` is `myAppMBean`.

For example:

```
<netuix:meta name="myCompany-configuration-page" content="myAppMBean" />
```

2. In the table JSP, in the `<wl:table>` tag, add the following attribute:
3. `checkBoxValue="handle"`
4. In the `<wl:column>` tag that renders the column from which you want to link, nest the `<wl:column-dispatch>` JSP tag:

```
<wl:column-dispatch perspective="perspective-name" />
```

where:

- `perspective-name` matches the `perspective-name` value that you specified in the `.book` file.

For example:

```

<wl:column property="Name"
  label="medrecMBean.name.label">
  <wl:column-dispatch perspective="myCompany-configuration-page" />
  </wl:column-link>
</wl:column>

```



## 7.4.8 Add Buttons and Check Boxes to Tables

In a table that you create using the `<wl:table>` tag, you can use buttons by themselves or in conjunction with a column of check boxes or radio buttons.

When used by themselves, buttons can forward to page UI control. For example, in the WebLogic Server Servers table (see [Figure 7-2](#)), users click on a New button to launch the Create a Server assistant.

When used in conjunction with a check box, buttons can process data on behalf of one or more table rows. For example, if each row in your table represents an instance of a custom MBean that provides monitoring data for your application, you can enable users to select a check box for one or more rows and click a button that resets the values in the corresponding MBean instances.

The following sections describe adding check boxes and buttons to tables:

- [Section 7.4.8.1, "Add Buttons to a Table"](#)
- [Section 7.4.8.2, "Add Check Boxes and Buttons to a Table"](#)
- [Section 7.4.8.3, "Example: How Check Boxes and Buttons Process Data"](#)

### 7.4.8.1 Add Buttons to a Table

To add buttons to a table:

1. In the table JSP, add the following attributes to the `<wl-extension:table>` tag:

```
singlechange="false"
controlsenabled="true"
```

The `controlsenabled` attribute enables the table to display buttons. The `singlechange` attribute enables users to click the button without having to lock the domain's configuration. (See [WebLogic Server JSP Tags Reference](#).)

2. Immediately after the `<wl-extension:table>` opening tag, add the following tags:

```
<wl:button-bar>
  <wl:button-bar-button labelid="button-label"
    pageLabel="page-definitionLabel" />
</wl:button-bar>
```

where:

- `button-label` is the text that you want to display on the button or the name of a property that you have defined in the bundle that has been declared in the JSP's `<fmt:setBundle>` element.
- `page-definitionLabel` is the unique label of the page that contains the instance of the portlet to which you want to forward.

The label is defined in the `definitionLabel` attribute of the `<netuix:page>` element, which is in the page's `.book` file.

For example, to link to the Servers table page:

```
<wl:button-bar>
  <wl:button-bar-button
    labelid="Servers"
    pageLabel="ServerTableBook" />
```

```
</wl:button-bar>
```

### 7.4.8.2 Add Check Boxes and Buttons to a Table

To process data on behalf of one or more table rows, use check boxes and a button to post the data to an HTTP request. You must also create a Struts `Action` or Page Flow that can retrieve and process the posted data:

1. To post data to an HTTP request on behalf of one or more table rows:
  - a. In your Struts configuration file, add a property named `chosenContents` to the definition of the table's `ActionForm` bean.

The data type for this property must be either an array of primitive types or of `com.bea.console.handles.Handle`.

The `<wls:table>` tag adds one element to this array for each check box that is selected when the user submits the table.

For example:

```
<form-property name="chosenContents"
type="[Lcom.bea.console.handles.Handle;"/>
```

- b. In the table JSP, add the following attributes to the `<wl-extension:table>` tag:

```
singlechange="false"
controlsenabled="true"
showcheckboxes="true"
checkBoxValue="property-name"
```

where *property-name* is the name of a property in the row bean. The data type of this property must match the data type that you have declared for the `chosenContents` property.

The `<wl:table>` tag adds the value of this row bean to the array in the table bean's `chosenContents` property.

If you want the table to render radio buttons, which allow users to select only a single row, add the following attribute:

```
singlechoice="true"
```

- c. Immediately after the `<wl-extension:table>` opening tag, add the following tags:

```
<wl:button-bar>
  <wl:button-bar-button labelid="button-label"
    portlet="portlet-instanceLabel"
    pageLabel="page-definitionLabel"/>
</wl:button-bar>
```

where:

*button-label* is the text that you want to display on the button or the name of a property that you have defined in the bundle that has been declared in the JSP's `<fmt:setBundle>` element.

*portlet-instanceLabel* is the label of a portlet instance that contains the Struts Action or Beehive Page Flow that you want to launch when a user clicks the button. The label is defined in the `instanceLabel` attribute of the

`<netuix:portletInstance>` element, which is in the `.book` file for the page that contains the portlet.

Instead of immediately launching an `Action` or `Page Flow`, you can specify a portlet that contains a JSP. The JSP can ask users for confirmation before launching an `Action` or `Page Flow`.

`page-definitionLabel` is the unique label of the page that contains the instance of the portlet to which you want to forward.

The label is defined in the `definitionLabel` attribute of the `<netuix:page>` element, which is in the page's `.book` file.

2. To create a Struts `Action` that can process the posted data:
  - a. Create a portlet that forwards to a Struts `Action`. Make sure that the portlet's `instanceLabel` matches the value that you specified in step 1c.

For example:

```
<netuix:portletInstance markupType="Portlet"
  instanceLabel="medrecMonitor.Tab.Portlet"
  contentUri="/portlets/medrec_monitor_tab.portlet"/>
```

For information about creating a portlet, see [Section 6.1, "Define a Portlet."](#)

- b. In your Struts configuration file, define an `ActionForm` bean that contains a property named `chosenContents`. The data type for this property must be the same data type that you specified in step 1a.

For example:

```
<form-bean name="processButtonForm"
  type="org.apache.struts.action.DynaActionForm">
  <form-property name="chosenContents"
    type="[Lcom.bea.console.handles.Handle;"/>
</form-bean>
```

- c. In your Struts configuration file, define a Struts `Action` mapping that sends the data in the `ActionForm` bean to a Java class for processing.

For example:

```
<action path="/ProcessButtonAction"
  type="com.bea.medrec.extension.MedrecMBeanButtonAction"
  name="processButtonForm"
  scope="request"
  validate="false">
  <forward name="success" contextRelative="true"
    path="/ext_jsp/button_view.jsp"/>
</action>
```

### 7.4.8.3 Example: How Check Boxes and Buttons Process Data

The following steps describe a table that correlates a table row with an underlying `MBean` data source and clears the values of attributes in the `MBean`:

1. In a table JSP, you configure the `<wl-extension:table>` tag to render check boxes. You specify that if a user selects the check box for a row, the value of the row bean's `handle` property will ultimately be posted to the request object:

```
<wl-extension:table
  showcheckboxes="true"
```

```
checkboxValue="handle"
...
>
```

The row bean's `handle` property contains a `JMXHandle` object, which contains the `ObjectName` of the MBean instance that populated the row.

2. When a user selects a row and clicks a button, the button adds the row bean's `JMXHandle` object to an array in the table bean's `chosenContents` property. Then it posts the table bean. (See [Figure 7-4](#).)
3. The Struts controller serializes the table bean (which is a Struts `ActionForm` bean) and writes the serialized bean in the HTTP request object. Then it forwards the request to a specified portlet.
4. The portlet launches a Struts `Action` mapping, which does the following:
  - a. Creates an `ActionForm` bean and populates it with data from the HTTP request.
  - b. Invokes an `Action` class and makes the `ActionForm` bean available to the class.
  - c. The `Action` class iterates over the form bean's `chosenContents` array (which contains instances of `JMXHandle`). For each element in the array, the class does the following:
    - d. Gets the MBean `ObjectName` that is encoded in the `JMXHandle` object,
    - e. Uses an `MBeanServer` to look up the MBean.
    - f. Uses an `MBeanServer` to invoke an MBean operation that clears an attribute value.
  - g. Upon success, the `Action` mapping forwards to a JSP.

**Figure 7-4 Example: Data Flow from Table to Struts Action**

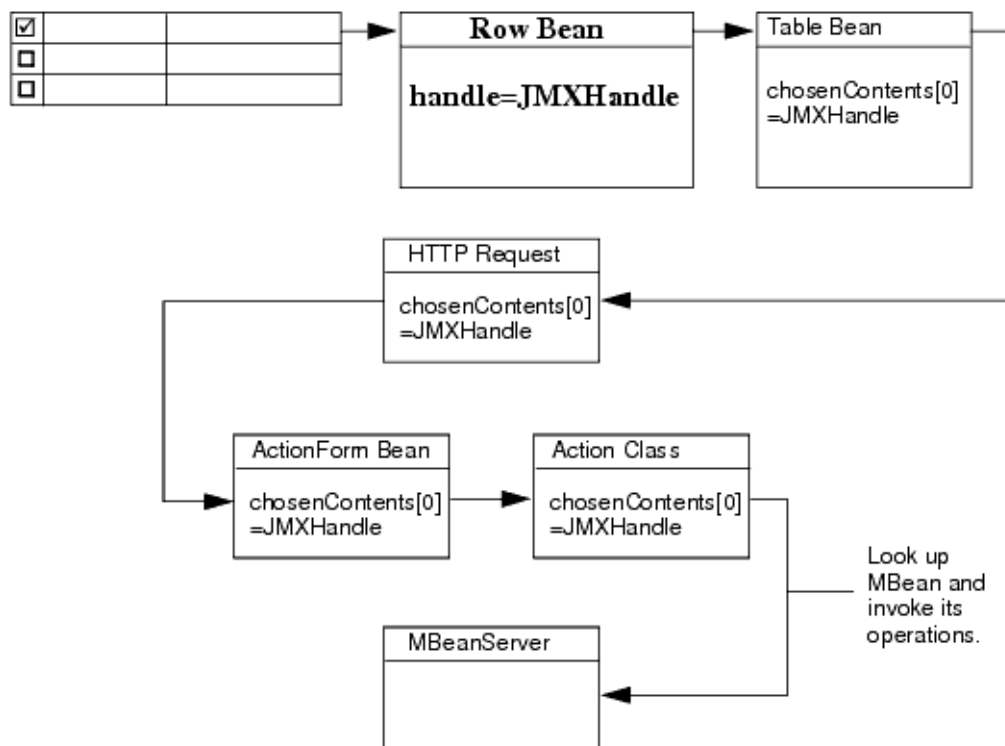

### 7.4.9 Configure Table Preferences

By adding a single attribute to the `<wl:table>` tag, you can enable your users to configure which table columns the table displays. The Administration Console persists the preference for each user and for each instance of the portlet that displays the table. If you reuse a table in multiple portlet instances, each user can set a different preference for the table in each portlet instance.

To enable users to configure the set of table columns that your table displays, add the following attribute to your `<wl:table>` tag: `customize="true"`.

For example:

```
<wl-extension:table
  customize="true"
  ...
>
```

When the Administration Console displays the JSP that contains the table, it renders a "Customize this table" link above the table title. The link causes the table JSP to display a section that contains a chooser control and an Apply or Reset button.

## 7.5 Create Other Portal Framework Files and Deploy the Extension

You can add your portlet directly to the desktop, but if you want your portlet to display as a tab or subtab in the ContentBook, you must define books or pages to contain it. In addition, you must create a `netuix-extension.xml` file which specifies where to locate your portlet, books, and pages and which functions as the deployment descriptor for your extension.

See [Chapter 6, "Adding Portlets and Navigation Controls."](#)



---

---

# Adding Online Help for Console Extensions

This chapter describes how to create help for a console extension and merge that help into the main Administration Console help system. The Administration Console help viewer is an Oracle WebLogic Portal Web application that uses an implementation of the open source help system JavaHelp 2.0.

This chapter includes the following sections:

- [Section 8.1, "Summary of Steps"](#)
- [Section 8.2, "Create the Helpset"](#)
- [Section 8.3, "Merging Helpsets"](#)
- [Section 8.4, "Localizing Helpsets"](#)
- [Section 8.5, "How Helpsets Are Merged"](#)
- [Section 8.6, "Provide Support for Context-Sensitive Help"](#)
- [Section 8.7, "Rebranding Help"](#)
- [Section 8.8, "Deploying Help"](#)

## 8.1 Summary of Steps

The main steps required for creating console extension help topics are as follows:

1. Create a Javahelp helpset, including the HTML topic files and the Javahelp control files.
2. Establish context-sensitive links from the console extension to help topics.
3. Deploy the help system with the console extension.

## 8.2 Create the Helpset

You can create a Javahelp system using the Javahelp software. Alternatively, you can use any help authoring tool that creates Javahelp. See the documentation for Javahelp or the documentation for your authoring tool for complete instructions.

For more information about JavaHelp and to download the Javahelp software, see *JavaHelp System* at <http://java.sun.com/javase/technologies/desktop/javahelp/>.

## 8.2.1 Helpset Files

The following files are required by the Administration Console help system. These files together are called a "helpset."

- Topic files (.html)  
These HTML files contain the help content. You can use any editor that can create HTML files to create these files.
- Helpset file (.hs)  
This XML file defines the helpset for the extension, including information such as the name and location of the map file, helpset title, etc.  
  
For a console extension helpset, the name of the Helpset file must start with the name of the extension. For example, the name of the Helpset file for the Jolt console extension is jolt.hs. (The Jolt console extension is a standard extension the Administration Console.) For localized helpsets, append the locale information to the end of the name of the extension, for example, jolt\_en\_US.hs.
- Mapping file (.jhm)  
This XML file maps context help IDs to help topics.
- Table of contents file (.xml)  
This XML file defines the table of contents for the help.

The following files are optional:

- Index file (.xml)  
This XML file defines the index for the help.
- Full text search database  
These database files are generated using the Javahelp software or a Help authoring tool that creates Javahelp:

There are further considerations for merging helpsets and for providing localized helpsets. See [Section 8.3.1, "Directory Structure for Merging Extension Help"](#) and [Section 8.4, "Localizing Helpsets."](#)

## 8.3 Merging Helpsets

The table of contents and the search database for a console extension's helpset are automatically merged into the main Administration Console help, provided that the extension's helpset is organized and named properly. Extension helpsets are merged only when the help is deployed on the same server instance as the Administration Console.

The Administration Console's helpset file sets the merge type to the Javahelp `AppendMerge` type. That type defines how console extension helpsets are merged into the main console help.

See "Merging Helpsets" at <http://www.oracle.com/technetwork/indexes/documentation/index.html> for more information about Javahelp merging. See also [Section 8.5, "How Helpsets Are Merged"](#) for more information about how helpsets are merged in WebLogic Server.



### 8.3.1 Directory Structure for Merging Extension Help

For an extension's help to be merged with the main console help, the help files must be organized as follows. The name of the directory containing the helpset files must be `bea-helpsets`.

```

... \console_extension\bea_helpsets\extension_name_locale.hs
... \console_extension\bea_helpsets\locale\extension_name-map.jhm
... \console_extension\bea_helpsets\locale\extension_name-toc.xml
... \console_extension\bea_helpsets\locale\extension_name-search\search database files
... \console_extension\bea_helpsets\locale\topics_dir\HTML topic files...
... \console_extension\bea_helpsets\locale\topics_dir\images\Graphic files...
... \console_extension\PortalConfig\...
... \console_extension\WEB-INF\...
... \console_extension\Other extension source directories...

```

---

**Note:** The HTML topic files and graphic files may be located in multiple directories and subdirectories, but they all must be under `... \console_extension\bea_helpsets\locale\`.

---

For example:

```

... \my_ext\webapp\bea_helpsets\my_ext_en_US.hs
... \my_ext\webapp\bea_helpsets\en_US\my_ext_map.jhm
... \my_ext\webapp\bea_helpsets\en_US\my_ext_toc.xml
... \my_ext\webapp\bea_helpsets\en_US\my_ext-search\search database files...
... \my_ext\webapp\bea_helpsets\en_US\pagehelp\HTML topic files...
... \my_ext\webapp\bea_helpsets\en_US\taskhelp\HTML topic files...
... \my_ext\webapp\bea_helpsets\en_US\taskhelp\images\Graphic files...
... \my_ext\webapp\jsp\...
... \my_ext\webapp\PortalConfig\...
... \my_ext\webapp\WEB-INF\...

```

## 8.4 Localizing Helpsets

Multiple localized helpsets can be simultaneously included in help. The help viewer uses the same strategy used by `java.util.ResourceBundle` for locating locale-specific help files. The help viewer expects the following directory structure under the `bea-helpsets` directory for your extension:

```

... \extension_name_locale_1.hs
... \extension_name_locale_2.hs
... \extension_name_locale_3.hs

... \locale_1\map.jhm
... \locale_1\toc.xml
... \locale_1\search\Search db files...
... \locale_1\topics\HTML topic files...
... \locale_1\topics\images\Graphic files... (optional)

... \locale_2\map.jhm
... \locale_2\toc.xml
... \locale_2\my_search\Search db files...
... \locale_2\topics\HTML topic files...
... \locale_1\topics\images\Graphic files... (optional)

... \locale_3\map.jhm

```

```

... \locale_3\ toc.xml
... \locale_3\search\Search db files...
... \locale_3\topics\HTML topic files
... \locale_3\topics\images\Graphic files... (optional)

```

For example, see [Figure 8–1](#).

**Figure 8–1 Directory Structure for Localized Help**

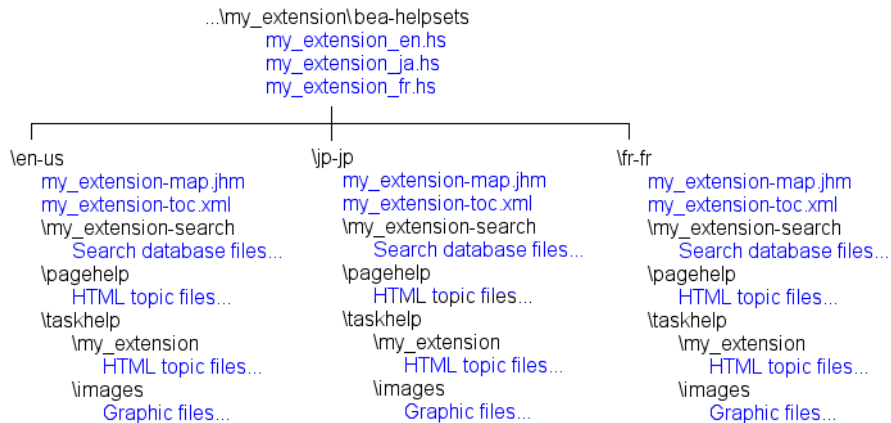

If the help content for the locale specified in the browser is not found, the help viewer displays the content from the default folder.

## 8.5 How Helpsets Are Merged

Administration Console helpsets are parsed and helpset objects are created and cached the first time a user requests help from the help viewer. The help viewer searches the server extension and domain extension folders for extension helpsets and merges them with the Administration Console helpsets. The console looks for extensions in these locations:

- `WL_HOME/server/lib/console-ext`
- `WL_HOME/server/lib/console-ext/autodeploy`
- `DOMAIN_HOME/console-ext`

Helpsets are merged according to the following rules:

1. If console help and extension help exist for the user-requested locale, the extension help is merged with the console help.
2. If console help and extension help do not exist for the user-requested locale, console help in English is displayed. The help viewer searches for extension help for the English locale and, if found, the extension help is merged with the console help.
3. If console help for the user-requested locale exists but extension help for that locale does not exist, the help viewer searches for the extension help for the English locale, and if found, the extension help is merged with the console help.
4. When searching for an extension's helpset for a particular locale, the help viewer looks for a helpset for the language, country, and variant. If all three are not found, the help viewer looks for the language and country. If that is also not found, the help viewer looks for the language, as shown in the following list.
  - a. language + "\_" + country + "\_" + variant

- b. language + "\_" + country
- c. language

## 8.6 Provide Support for Context-Sensitive Help

Users request help from the Administration Console by clicking the **Help** link in the content header menu at the top of the Administration Console. That link displays the help topic for the current page.

To provide context sensitive help for console extension pages, you must

- [Section 8.6.1, "Provide Help IDs"](#) for books, pages, or targets within pages.
- [Section 8.6.2, "Map Help IDs to Help Files"](#) in the Javahelp map (.jhm) file.

At this time, console extension developers cannot provide links in the How do I... pane on the left side of the Administration Console or More Info... links in the configuration and monitoring pages on the right side.

### 8.6.1 Provide Help IDs

Each Portal page or book can have a help ID, and targets in pages can have help IDs. You must specify `helpids` or `helpurlpatterns`.

#### 8.6.1.1 helpid

Specify the help context for portal pages and books by specifying a help ID and a bundle name using a meta-tag with the name `helpid`. Separate the help ID and the bundle name with a semicolon (;). Alternatively, portals and books can inherit the context from ancestor pages or books.

Help IDs can contain only alphanumeric characters, hyphens (-) and underscores (\_). Any other characters are rejected, and a generic error message is displayed.

The help Web application reads the help ID and bundle name from the `helpid` meta-data. If the page or book does not set a `helpid`, the help application recursively searches parent pages and books to get a `helpid`. The `helpid` from the closest parent is used.

The overall Home book for the Administration Console has a `helpid`, which ensures that if a `helpid` for a context is not found, the default help page for the console is displayed. The `helpid` value is assigned to a JavaScript variable, `bea.wls.console.pageHelpKey`.

When the **Help** link in the content header is clicked, the `helpid` is passed as a query parameter to the help Web application. The help Web application uses the `helpid` to query the helpset mapping (.jhm) file and returns the help resource.

The following example shows how the `helpid` is assigned for the Configuration > General tab of the Settings for JoltConnectionPool page of the Jolt console extension. This snippet is taken from the `JoltFullFeatures.book` file.

```
<netuix:page markupName="page"
  markupType="Page"
  definitionLabel="JoltConnectionPoolConfigGeneralTabPage"
  title="tab.general.label" presentationClass="page-content">
<netuix:meta name="helpid"
  content="Jolt.jolt.joltconnectionpoolconfiggeneral.title;jolt"/>
```

### 8.6.1.2 helpurlpattern

The Administration Console provides an alternate method for invoking help. A general help URL pattern can be defined using `helpurlpattern` meta-data tag in portal pages and books. The value of the pattern can contain variables that can be substituted in any page/book using a `netuix` meta tag. For example, set the value of `helpurlpattern` meta-tag as follows:

```
<netuix:meta name="helpurlpattern" content=
  "/consolehelp/console-help.portal?_nfpb=true&_pageLabel=page&helpId=${helpid}"/>
```

and then specify the `helpid` value using `<netuix:meta>` tag.

```
<netuix:meta name="helpid" content="applications.CreateDeploymentPlan"/>
```

The `helpid` variable in the URL pattern is substituted by the value provided in the `helpid` meta-tag.

The `helpurlpattern` can be specified in any page or book. If not specified, the parent pages and books are searched recursively to find a `helpurlpattern`. The `helpurlpattern` from the closest parent is used. Once a pattern is found, any variable substitution values that are defined in the current page or book are applied to the URL pattern to arrive at a valid URL.

The `helpurlpattern` is convenient way when you want to provide an alternate URL for an extension's help. Consider an extension named `my_extension`. You want to direct a request for help to a Web page. The extension `my_extension` defines the `helpurlpattern` in the root page or book as follows:

```
<netuix:meta name="helpurlpattern"
  content="http://my_web_site.com/my_product/docs/${product_name}/index.html"/>
```

A `product_name` meta-tag can provide a value for substitution.

```
<netuix:meta name="product_name" content="my_extension"/>
```

The resulting help link points to `http://my_web_site.com/my_product/docs/my_extension/index.html`.

## 8.6.2 Map Help IDs to Help Files

Map the help IDs defined in portal pages and books to the HTML help topic files in the `Javahelp` map (`.jhm`) file. For example, the following element in the map file associates the help ID `domainconfig` to the topic file `domainConfig.html`, which is located in the `Pages` directory.

```
<mapID target="domainconfig" url="Pages/domainConfig.html"/>
```

The path to the specified topic file is relative to the location of the map file, which is in the `locale` directory. See [Section 8.3.1, "Directory Structure for Merging Extension Help."](#)

## 8.7 Rebranding Help

The help Web application can be rebranded by providing a Look and Feel (LAF) and targeting it to the help Web application's portal (`console-help.portal`). An extension LAF can rebrand the help Web application only if it is deployed on the same server instance as the Administration Console Web application. For information about changing the look and feel, see [Chapter 5, "Rebranding the Administration Console."](#)

## 8.8 Deploying Help

Extension help is merged onto console help only if the help Web application is deployed on the same server instance as the console. It will not merge if the help Web application is deployed on a different server instance.

Similarly, help Web application are rebranded only if the help Web application is deployed on the same server instance.



---

---

# Archiving and Deploying Console Extensions

This chapter describes how to archive and deploy a console extension after you create a directory tree of source files, precompiled JSP files, and Java class files. After you create this directory tree for your console extension, you archive the directory tree in a WAR file and copy the WAR file into your WebLogic Server domain. For information about the files and directories to create in your extension's directory tree, see [Section 3.3, "Create a Directory Tree for the Extension"](#).

If you want to divide your console extensions into independently deployable components, you can create and deploy multiple archives that contain subsets of your extension. Each archive must contain all of the classes and portal framework files needed to render its own content. For example, if your extension modifies the Administration Console Look and Feel as well as adds portlets to the desktop, you can create one archive for the Look and Feel extension and another archive that contains the files needed to add your portlet to the desktop.

## 9.1 Archive and Deploy a Console Extension

To archive and deploy your console extension:

1. Archive your extension directory into a WAR file. The name of the WAR file has no programmatic significance, so choose a name that is descriptive for your purposes.

The contents of your *root-dir* directory must be the root of the archive; the *root-dir* directory name itself must not be in the archive. If you use the Java `jar` command to create the archive, enter the command from the *root-dir* directory. For example:

```
c:\root-dir> jar -cf my-extension.war *
```

2. Copy the WAR file into each domain's *domain-dir/console-ext* directory, where *domain-dir* is the domain's root directory.
3. Restart the Administration Server for each domain.

### 9.1.1 Error Output During Deployment

If the Administration Console encounters deployment errors, it outputs error and warning messages to standard out and to the Administration Server's server log file.

If you do not see error or warning messages and you do not see your extension in the Administration Console, you might have named the wrong parent UI control in your `netuix-extension.xml` file. For example, if you name a parent UI control that does

not render tabs for its children, then your extension is deployed but there is no menu control for accessing it.