

Oracle® Application Server
CDC Adapters for VSAM User's Guide
11g Release 1 (11.1.1)
E16095-02

January 2011

Oracle Application Server CDC Adapters for VSAM User's Guide, 11g Release 1 (11.1.1)

E16095-02

Copyright © 2005, 2011, Oracle and/or its affiliates. All rights reserved.

Primary Author: David Goldman

Contributor: Sami Zeitoun, Itamar Ankorion, Marian Jones, Vikas Anand, Vimmika Dinesh, Manoj Neelapu

This software and related documentation are provided under a license agreement containing restrictions on use and disclosure and are protected by intellectual property laws. Except as expressly permitted in your license agreement or allowed by law, you may not use, copy, reproduce, translate, broadcast, modify, license, transmit, distribute, exhibit, perform, publish, or display any part, in any form, or by any means. Reverse engineering, disassembly, or decompilation of this software, unless required by law for interoperability, is prohibited.

The information contained herein is subject to change without notice and is not warranted to be error-free. If you find any errors, please report them to us in writing.

If this software or related documentation is delivered to the U.S. Government or anyone licensing it on behalf of the U.S. Government, the following notice is applicable:

U.S. GOVERNMENT RIGHTS Programs, software, databases, and related documentation and technical data delivered to U.S. Government customers are "commercial computer software" or "commercial technical data" pursuant to the applicable Federal Acquisition Regulation and agency-specific supplemental regulations. As such, the use, duplication, disclosure, modification, and adaptation shall be subject to the restrictions and license terms set forth in the applicable Government contract, and, to the extent applicable by the terms of the Government contract, the additional rights set forth in FAR 52.227-19, Commercial Computer Software License (December 2007). Oracle USA, Inc., 500 Oracle Parkway, Redwood City, CA 94065.

This software is developed for general use in a variety of information management applications. It is not developed or intended for use in any inherently dangerous applications, including applications which may create a risk of personal injury. If you use this software in dangerous applications, then you shall be responsible to take all appropriate fail-safe, backup, redundancy, and other measures to ensure the safe use of this software. Oracle Corporation and its affiliates disclaim any liability for any damages caused by use of this software in dangerous applications.

Oracle is a registered trademark of Oracle Corporation and/or its affiliates. Other names may be trademarks of their respective owners.

This software and documentation may provide access to or information on content, products, and services from third parties. Oracle Corporation and its affiliates are not responsible for and expressly disclaim all warranties of any kind with respect to third-party content, products, and services. Oracle Corporation and its affiliates will not be responsible for any loss, costs, or damages incurred due to your access to or use of third-party content, products, or services.

Contents

Preface	ix
1 Introduction	
OracleAS CDC Adapter for VSAM Overview	1-1
OracleAS CDC Adapter for VSAM Architecture	1-2
The Staging Area	1-4
2 Configuring the OracleAS CDC Adapter for VSAM	
Setting Up the IBM z/OS Platform in Oracle Studio	2-1
Securing Access to Oracle Connect	2-2
Setting Password Access to Oracle Studio	2-2
Specifying Users with Administrative Rights	2-3
Setting Up Run-Time User Access to the IBM z/OS Platform	2-5
Setting up Metadata for the OracleAS VSAM Data Source	2-6
Setting Up the VSAM Data Source	2-6
Configuring the Data Source Driver	2-8
VSAM (CICS) Properties	2-8
VSAM Properties	2-9
Configuring the Data Source Driver Advanced Properties	2-9
Importing Metadata for the VSAM Data Source	2-11
Select the COBOL Copybooks	2-11
Applying Filters	2-14
Selecting Tables	2-15
Import Manipulation	2-16
Create VSAM Indexes	2-24
Assigning File Names	2-25
Assigning Index File Names	2-25
Metadata Model Selection	2-26
Importing the Metadata	2-27
Verifying the Metadata Definition	2-28
Setting Up a Change Data Capture with the OracleAS CDC Adapter for VSAM	2-29
Managing the CICS User Journal (VSAM CICS Only)	2-29
Setting up the CICS User Journal for VSAM	2-29
Print the CICS User Journal Content	2-30
Configuring the Logger (VSAM Batch Only)	2-31

Creating the Logstream.....	2-31
Creating the CDC\$PARM Data Set	2-32
Updating Jobs and Scripts	2-32
Setting up a Change Data Capture in Oracle Studio	2-33
Create a CDC Project	2-34
Set up the CDC Server.....	2-36
Set up the Staging Area Server	2-43
Deploying a Change Data Capture	2-52
Activating and Deactivating Solution Workspaces	2-55

3 WebLogic Deployment and Adapter Integration

Configuring the VSAM CDC Adapter In the Application Server	3-1
CDC Stream Positions Table Definition.....	3-1
Configuring the VSAM CDC Adapter Connection Factory	3-2
Configuring the JCA Configuration Files for the OracleAS CDC Adapter for VSAM	3-3
Creating JCA Configuration Files.....	3-3
Configuring the Binding File.....	3-4
High Availability	3-5
Troubleshooting Rollback Loops	3-6

4 Configuring a VSAM CDC Adapter

Creating Outbound Interactions with the OracleAS Adapter for VSAM	4-1
Requirements	4-1
Adding the VSAM Hospital Data Source	4-1
Prepare the System.....	4-1
Set up Machine Access to Oracle Connect.....	4-1
Add an VSAM Data Source	4-2
Import the Metadata	4-3
Create a Change Data Capture	4-3
Setting up a Change Data Capture	4-4
Deploy the Solution	4-5
Create the JCA Configuration Files	4-5

5 Creating the Project in JDeveloper Examples

Getting Started	5-1
Prerequisites.....	5-1
Beginning Tasks	5-2
Deploy a BPEL Inbound Process	5-2
Design-Time Configuration	5-3
Create a BPEL Inbound Process.....	5-3
Use a Third-Party Adapter for the Inbound Process	5-4
Design the BPEL Inbound Process	5-6
Deploy the Project.....	5-9
Run-time Configuration	5-9
Triggering the Event using the XML Utility	5-9
Mediator Inbound Process	5-10

Beginning Tasks	5-11
Create a Mediator Inbound Process	5-11
Use a Third-Party Adapter for the Inbound Process	5-13
Create a File Adapter	5-14
Design an Inbound Mediator	5-16
Create Mapping Rules and Map the Files	5-17
Deploy the Project	5-17

6 Run-time Tasks and Troubleshooting

Adding and Removing Tables	6-1
Handling Metadata Changes	6-2
Staging Area Maintenance	6-3
Monitoring the Change Data Capture	6-4
Service Context Table	6-4
Monitoring the Status	6-5
Daemon Life-Cycle Tasks	6-7
Starting the Daemon	6-7
Task: Starting the Daemon	6-7
Shutting Down the Daemon.....	6-7
Monitoring the Daemon During Run time.....	6-8
Daemon (Computer) Options	6-8
Workspace Options	6-9
Server Options.....	6-9
Daemon Logs	6-10
The Log Monitor	6-10
Resolving Communication Errors	6-11
Resolving Specific Errors	6-12

7 Advanced Features of OracleAS CDC Adapter for VSAM

Configuring the Daemon for High Availability	7-1
Adding a New Daemon Workspace Configuration.....	7-1
Editing the Workspace	7-2
Configuring the Server Mode.....	7-2
Configuring a Binding Environment	7-6
Debug.....	7-7
General.....	7-8
Language	7-8
Modeling	7-9
ODBC	7-9
OLEDB	7-9
Optimizer	7-9
Parallel Processing	7-10
Query Processor	7-10
Transactions	7-13
Tuning.....	7-13
XML.....	7-14

Migration Considerations	7-15
Security Considerations	7-15
Setting Design Time Security	7-16
Setting Run Time Security	7-16
Transaction Support	7-17

A Advanced Tuning of the Metadata

Metadata for the VSAM Data Source	A-1
General Tab	A-1
Columns Tab.....	A-3
Column Definition Section	A-4
Column Properties.....	A-5
Indexes Tab	A-7
Table Information	A-7
Properties	A-8
Statistics Tab.....	A-9
Generating Statistics	A-10
Advanced Tab.....	A-11
Adapter Metadata	A-13
Adapter Metadata General Properties	A-13
Adapter Metadata Interactions	A-15
Interaction Advanced Tab	A-16
Adapter Metadata Schema Records	A-18
Adapter Metadata XML	A-20

B Advanced Tuning of the Daemon

Control	B-1
Logging	B-3
Security	B-5
Workspaces	B-7
General.....	B-7
Server Mode.....	B-11
Security	B-16

C Editing Properties for the OracleAS CDC Adapter for VSAM

Editing Properties in Oracle Studio	C-1
Editing the OracleAS CDC Adapter Properties.....	C-1
Configuration Properties	C-2
CDC Logger Properties	C-2
CDC\$PARM Properties (VSAM Batch Only).....	C-2
OracleAS CDC Adapter Configuration Properties	C-3
CDC Queue Adapter Properties.....	C-3
Common CDC Adapter Properties	C-4
Change Router Properties.....	C-5
Referential Integrity Considerations	C-8
Access to Change Events	C-10

Transaction Support	C-11
Single Program Transaction Manager.....	C-11
Logical Transaction Manager	C-12
Security.....	C-12
D Back-end Adapter Data Type Support	
Data Type Mapping.....	D-1
E Globalization Settings	
Defining the Language and Code Page.....	E-1
F Editing XML Files in Oracle Studio	
Preparing to Edit XML Files in Oracle Studio	F-1
Making Changes to the XML File	F-2
Remove Objects	F-2
Add DTD Information.....	F-2
Edit Namespaces	F-3
Add Elements and Attributes.....	F-5
Replace an Element.....	F-5

Index

Preface

This guide is the primary source of user and reference information on the OracleAS CDC Adapter for VSAM, which enables Oracle users to use change data capture in their integration architecture, working with the Oracle Application Server. This preface includes the following topics:

- [Audience](#)
- [Documentation Accessibility](#)
- [Related Documents](#)
- [Conventions](#)

Audience

This guide is intended for Oracle integration administrators and developers who perform the following tasks:

- Installing and configuring OracleAS CDC Adapter for VSAM
- Diagnosing errors
- Using OracleAS for developing integration solutions using change data capture

Note: You should understand the fundamentals of OracleAS, WebLogic, the UNIX and Microsoft Windows operating system before using this guide to install or administer OracleAS Adapters for VSAM.

Note: For the purposes of this version of the Oracle Weblogic Server, Oracle Application Server refers to the Oracle WebLogic Server and OracleAS refers to Oracle WLS.

Documentation Accessibility

Our goal is to make Oracle products, services, and supporting documentation accessible to all users, including users that are disabled. To that end, our documentation includes features that make information available to users of assistive technology. This documentation is available in HTML format, and contains markup to facilitate access by the disabled community. Accessibility standards will continue to evolve over time, and Oracle is actively engaged with other market-leading technology vendors to address technical obstacles so that our documentation can be accessible to all of our customers. For more information, visit the Oracle Accessibility Program Web site at <http://www.oracle.com/accessibility/>.

Accessibility of Code Examples in Documentation

Screen readers may not always correctly read the code examples in this document. The conventions for writing code require that closing braces should appear on an otherwise empty line; however, some screen readers may not always read a line of text that consists solely of a bracket or brace.

Accessibility of Links to External Web Sites in Documentation

This documentation may contain links to Web sites of other companies or organizations that Oracle does not own or control. Oracle neither evaluates nor makes any representations regarding the accessibility of these Web sites.

Access to Oracle Support

Oracle customers have access to electronic support through My Oracle Support. For information, visit <http://www.oracle.com/support/contact.html> or visit <http://www.oracle.com/accessibility/support.html> if you are hearing impaired.

Related Documents

For more information, see the following documents in the Oracle Other Product One Release 10.0 documentation set or in the Oracle Other Product Two Release 6.1 documentation set:

- *Oracle Application Server Adapter Concepts Guide*
- *Oracle Application Server Adapter Installation Guide*
- *Oracle Application Server Adapter Concepts Guide*
- *Oracle Application Server Containers for J2EE User's Guide*
- *Oracle Application Server Containers for J2EE Services Guide*
- *Oracle Application Server Containers for J2EE Security Guide*

Conventions

The following text conventions are used in this document:

Convention	Meaning
boldface	Boldface type indicates graphical user interface elements associated with an action, or terms defined in text or the glossary.

Convention	Meaning
<i>italic</i>	Italic type indicates book titles, emphasis, or placeholder variables for which you supply particular values.
monospace	Monospace type indicates commands within a paragraph, URLs, code in examples, text that appears on the screen, or text that you enter.

Introduction

Change data capture (CDC) is an integration technology that enables efficient near real-time integration by capturing changes made to enterprise data sources and providing them for processing in integration middleware, such as Oracle Fusion Middleware. The CDC Adapter can be used by Oracle SOA Suite (BPEL Process Manager, Oracle Enterprise Service Bus) and Oracle Data Integrator (ODI).

The OracleAS CDCAdapter for VSAM captures changes for captured VSAM clusters that are written to the CICS User Journal or updated by batch programs.

OracleAS CDC Adapter

OracleAS CDC Adapter

This chapter provides an overview of the features and architecture of the OracleAS CDC Adapter for VSAM. It includes the following topics:

- [OracleAS CDC Adapter for VSAM Overview](#)
- [OracleAS CDC Adapter for VSAM Architecture](#)

1.1 OracleAS CDC Adapter for VSAM Overview

The OracleAS CDC Adapter for VSAM captures and delivers changes (such as insert, update, and delete operations) made to data in VSAM data sources. By using the CDC Adapter, you can build efficient data integration solutions that use VSAM data, synchronize systems to ensure data integrity, update data warehouses and operational data stores in near real-time, and enable event-driven business activity monitoring and processing.

The OracleAS CDC Adapter for VSAM has the following capabilities:

- **Non-intrusive change capture:** The OracleAS CDC Adapter for VSAM is a log-based CDC technology. The CDC agent accesses a logstream that is polled to access the changes. The agent begins polling from a specific point called the stream position (or agent context). The last position read is saved as the stream position. This next time the agent polls the logstream for information, it starts at the saved stream position.
- **Real-time data capture:** The OracleAS CDC Adapter for VSAM captures changes to data in near-real-time for applications that demand zero latency and require the most up-to-date data. Unlike scheduled CDC solutions, near real-time data capture guarantees that a change event is can be made available in a matter of seconds at the consumer. The term near-real-time data capture is used because after a period of inactivity changes may be available after a few seconds.

- Change storage:** The Oracle CDC Adapter for VSAM provides a staging area that stores the captured changes in a format that is easy to access and process. The staging area ensures that changes are persisted until they are processed, and provides facilities to clean up old change records.
- Change access and delivery:** The Oracle CDC Adapter for VSAM includes a JCA Resource Adapter that can be configured in BPEL and ESB as an inbound endpoint, delivering changes in XML format.
- Filtering:** The OracleAS CDC Adapter for VSAM enables you to filter captured data based on the type of operation (INSERT, UPDATE, DELETE), based on column selection and even based on specific column values.
- Reliable delivery and recovery:** The Oracle CDC Adapter for VSAM stores changes in a reliable persistent storage and uses the concept of a 'stream position' that indicates the location in the change stream that was successfully moved and processed. By storing stream positions, the CDC Adapter can always restart after failure, recover, and continue moving and delivering changes from wherever it was stopped.
- Ease of use:** The OracleAS CDC Adapter for VSAM provides an easy and intuitive way to configure CDC solutions using Oracle Studio.

Using the OracleAS CDC Adapter for VSAM makes ETL (extract, transform, and load) processes more efficient and less disruptive to the operation of the source database systems, eliminating the need for the traditional ETL downtime window.

1.2 OracleAS CDC Adapter for VSAM Architecture

The following figure illustrates the system components used for change data capture using the OracleAS CDC Adapter for VSAM.

Figure 1-1 Component Architecture used with the VSAM CDC adapter

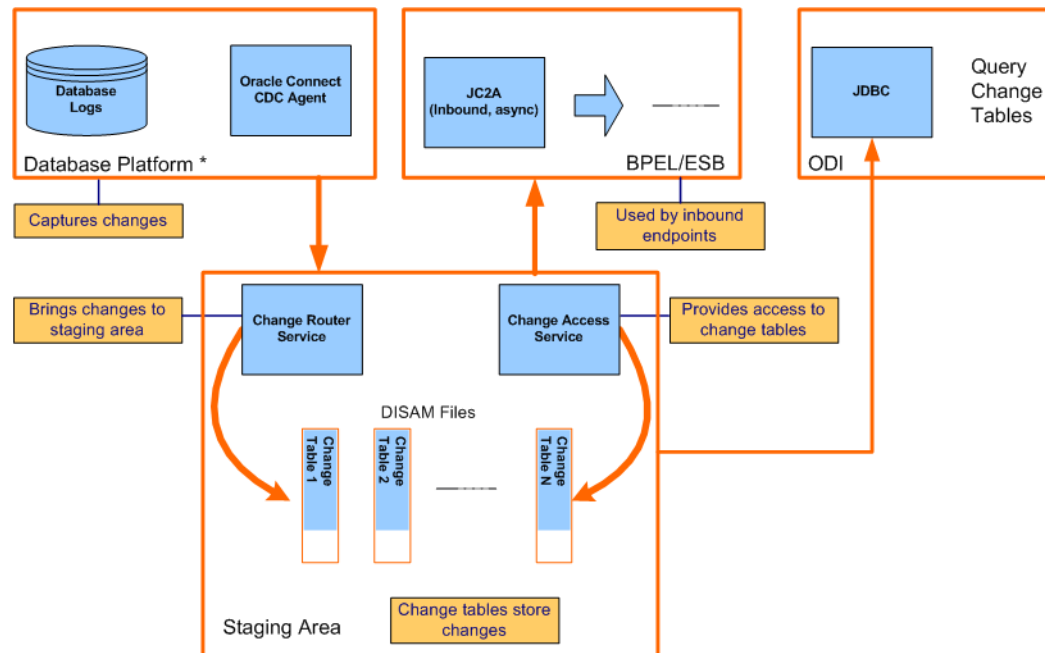

The OracleAS CDC Adapter for VSAM component architecture includes the following components:

- **Database Platform:** The database platform is the data source that contains the data to be captured.
- **Database Log:** The database log is a log stream that contains the raw change data.
- **Oracle Connect:** Oracle Connect runs on the back-end system and handles the special J2CA adapter that runs on the Oracle Application Server.
- **CDC agent:** This is an OracleAS CDC Adapter for VSAM component that runs under the control of the daemon (a listener process) on the computer where the back-end data is located. The capture agent provides access to change events in the transaction log for the change router.

The agent is located on the same computer as the changes to be captured. It maintains the last position read in the journal (the stream position or context) and starts at this point the next time it polls the journal. The context is stored in the repository where the adapter definition is stored. The adapter definition includes a single primary interaction, which is used to access the appropriate journal and includes the list of tables to monitor for changes.

- **BPEL/ESB:** This is where the change events are consumed by a JCA provider that sends change records to an end point configured in either ESB or BPEL.
- **JC2A Resource Adapter:** This is a special version of the J2CA 1.5 VSAM adapter that can read change records from the staging area. It implements inbound endpoints for BPEL and ESB that pulls change events from the staging area and deliver them as XML change documents. Each endpoint handles change records for a single captured table at the source database.

The J2CA adapter uses multiple connections to the staging area to process changes from multiple tables in parallel.

- **JDBC Driver:** This enables access to changes in the staging area using SQL queries.
- **WebLogic / BPEL Components:** Any OracleAS component that hosts and gets messages from the JC2A adapter.
- **Staging Area:** This is a set of change tables where change records are stored before being sent to BPEL/ESB. Old records from the Staging Area are deleted based upon the specified aging policy.

The Staging Area contains a DISAM data source for SQL access and a Database Events adapter for the XML access. For more information, see [The Staging Area](#) for more information.

The staging area includes the following components:

- **Change Router:** This is an OracleAS CDC Adapter for VSAM service that runs under the control of the daemon (a listener process) on the Oracle platform. The change router reads the change stream from the CDC agent, sorts them in transaction/commit order eliminating rolled-back changes, and distributes the changes into the various change tables.

Only one instance of the change router is active at a time against a captured database. The change router also deletes old changes from the change tables according to a configurable aging policy. policy (48 hours is the default, which means that records that have been in the staging area for more than 48 hours are deleted).

- **Change Tables:** These are tables in the staging area that contain changes to one captured table in the source database. These change tables maintain change events in transaction order and in occurrence order within a

transaction for each captured table. The change tables are DISAM files that are indexed to support fast access to the change data, that can be accessed directly using the stream position.

- **Change Access Service.** This is an instance Oracle Connect that is installed on a separate computer or the same computer as BPEL/ESB that allows access to the change tables. This instance of Oracle Connect is configure as the staging area.
- **Oracle Studio:** Provides the developer or administrator with a graphical user interface for setting up the CDC Agent and Staging Area,using intuitive wizards. Oracle Studio can be installed on Linux, UNIX, or Windows.

1.2.1 The Staging Area

The staging area is an area used by Oracle Connect to store captured data from a journal. The journal is scanned once and changes for every required table read during that scan are passed to the staging area, where they are stored. Therefore, the journal is scanned once each time it is polled. After the changes are written to the staging area, processing of these changes is carried out independently of the journal.

The staging area is a benefit when transactions are used. The changed data is not written to the change queue until the transaction is committed. Thus, if the transaction fails, there is no overhead of having to back out any processing done with the steps in the failed transaction.

The staging area can be on any computer with a Windows, Linux, or UNIX operating system that is running the Oracle Application Server and does not need to be run on the same server as the VSAM CDC adapter. Once the information is extracted from the journal and written to the staging area, processing of changes is carried out on the staging area only. Thus, the staging area should be set up to consider the network configuration and where the consumer application runs.

The staging area maintains the last position read by the consumer application (the staging area context) and starts at this point the next time a request from the consumer application is received. The context is stored in the repository where the staging area is maintained.

The staging area is indexed so that access to the staging area for a specific stream is quick.

The staging area is automatically cleared every 48 hours. All events that have been in the staging area for more than 48 hours are deleted.

Configuring the OracleAS CDC Adapter for VSAM

This chapter describes how to configure a change data capture using the OracleAS CDC Adapter for VSAM.

Most of the configurations are done using Oracle Studio. To use Oracle Studio, you first configure it to enable access to the z/OS computer where the VSAM data resides. Then you set up a VSAM data source and finally create the change data capture solution.

This chapter contains the following topics:

- [Setting Up the IBM z/OS Platform in Oracle Studio](#)
- [Securing Access to Oracle Connect](#)
- [Setting up Metadata for the OracleAS VSAM Data Source](#)
- [Setting Up a Change Data Capture with the OracleAS CDC Adapter for VSAM](#)

Note: These tasks assume you have permission to access the IBM z/OS platform and that the Oracle Connect daemon is running on this computer.

Check with the system administrator to ensure these requirements are fulfilled.

2.1 Setting Up the IBM z/OS Platform in Oracle Studio

Using Oracle Studio, perform the following steps to configure the IBM z/OS platform:

1. From the **Start** menu, select **Programs, Oracle**, and then select **Studio**. Oracle Studio opens.
2. Right-click **Machines** in the Configuration Explorer and select **Add Machine**. The Add Machine screen is displayed.

Figure 2–1 The Add Machine screen

3. Enter the name of the computer you want to connect to, or click **Browse** to select the computer from the list of computers that is displayed and which use the default port 2551.
4. Specify the user name and password of the user who was specified as the administrator when Oracle Connect was installed.

Note: Selecting **Anonymous connection** enables anyone having access to the computer to be an administrator, if this was defined for the computer.

5. Click **Finish**.

The computer is displayed in the Configuration Explorer.

2.2 Securing Access to Oracle Connect

Oracle Studio includes mechanisms to secure access to Oracle Connect both during modeling and run time.

During modeling the following security mechanisms can be applied:

- [Setting Password Access to Oracle Studio](#)
- [Specifying Users with Administrative Rights](#)

During run time client access to Oracle Connect is provided by the user profile:

- [Setting Up Run-Time User Access to the IBM z/OS Platform](#)

2.2.1 Setting Password Access to Oracle Studio

Initially, any operation performed using Oracle Studio does not require a password. You can set a password so that the first operation that involves accessing the server from Oracle Studio requires a password to be entered.

Perform the following steps to set the password:

1. From the **Start** menu, select **Programs, Oracle**, and then select **Studio**.
2. Select **Window** from the menu bar and then select **Preferences**. The Preferences screen is displayed.
3. Select the **Studio** node, as shown in the following figure:

Figure 2–2 The Preferences screen

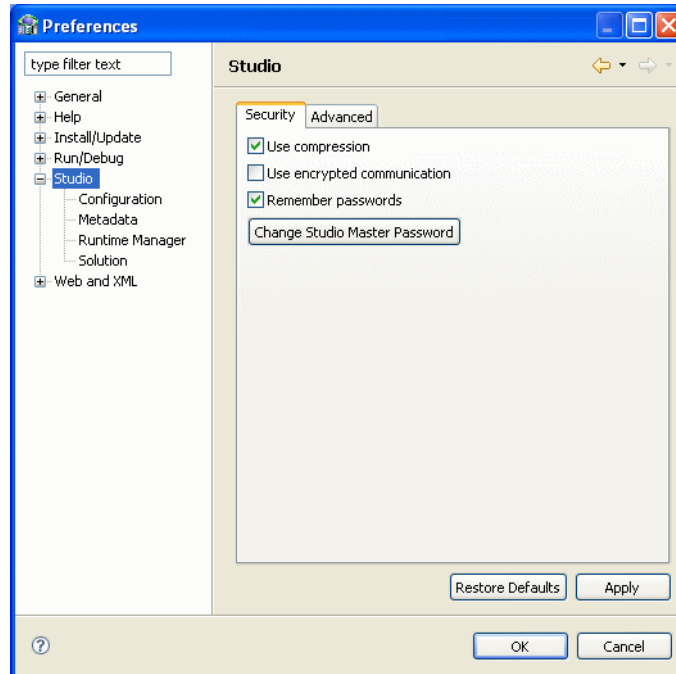

4. Click **Change master password**. The Change Master Password screen is displayed as shown in the following figure:

Figure 2–3 The Change Master Password screen



5. Leave the **Enter current master password** field blank and type a new master password in the **Enter new master password** field.
6. Enter the new password again in the **Confirm new master password** field.
7. Click **OK**.

2.2.2 Specifying Users with Administrative Rights

By default, only the user who was specified during the installation as an administrator has the authorization to modify settings on that computer from Oracle Studio. This

user can then authorize other users to make changes or to view the definitions for a selected computer. Adding a computer to Oracle Studio is described in "[Setting Up the IBM z/OS Platform in Oracle Studio](#)".

Note: The default during installation is to enable all users to be administrators.

1. From the **Start** menu, select **Programs, Oracle**, and then select **Studio**.
2. In the Design perspective Configuration view, Right-click the computer and select **Administration Authorization**.

The Administration Authorization screen is displayed as shown in the following figure.

Figure 2–4 The Administration Authorization Identities tab

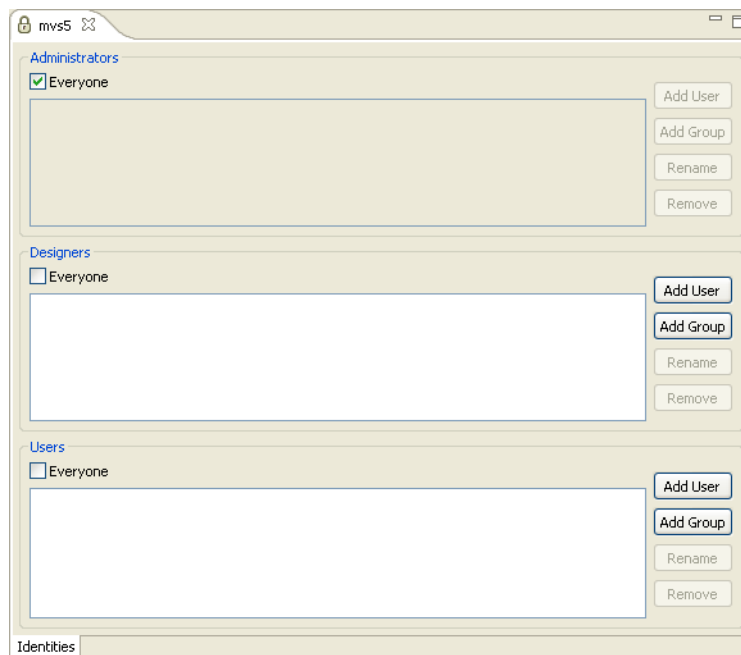

The screen has the following sections:

Administrators: Administrators can view and modify all the definitions in Oracle Studio for the selected computer. On initial entry to Oracle Studio, every user is defined as a system administrator.

Designers: Designers can view all the definitions for the computer in Oracle Studio and can modify any of the definitions under the Bindings and Users nodes for the selected computer. For example, Oracle Studio database administrator can add new data sources and adapters and can change metadata definitions for a table in a data source.

Users: Users can view all the definitions for the computer in Oracle Studio for the selected computer. Regular users cannot modify any of the definitions.

3. Add users or groups of users by clicking **Add User** or **Add Group** for the relevant sections.

The user or group that is added must be recognized as a valid user or group for the computer. Once a name has been added to a section, only the user or group that logs on with that user name has the relevant authorization.

2.2.3 Setting Up Run-Time User Access to the IBM z/OS Platform

During run time, client access to Oracle Connect is provided by the user profile. A user profile contains name and password pairs that are used to access a computer, data source or application at run time, when anonymous access is not allowed.

1. From the **Start** menu, select, **Programs, Oracle**, and then select **Studio**. Oracle Studio opens.
2. From the Design perspective, Configuration view, expand the **Machines** folder, then expand the machine where you want to set the user name and password.
3. Expand **Users**.
4. Right-click **NAV** and select **Open**. The NAV user profile editor is displayed.

Figure 2–5 The User Editor

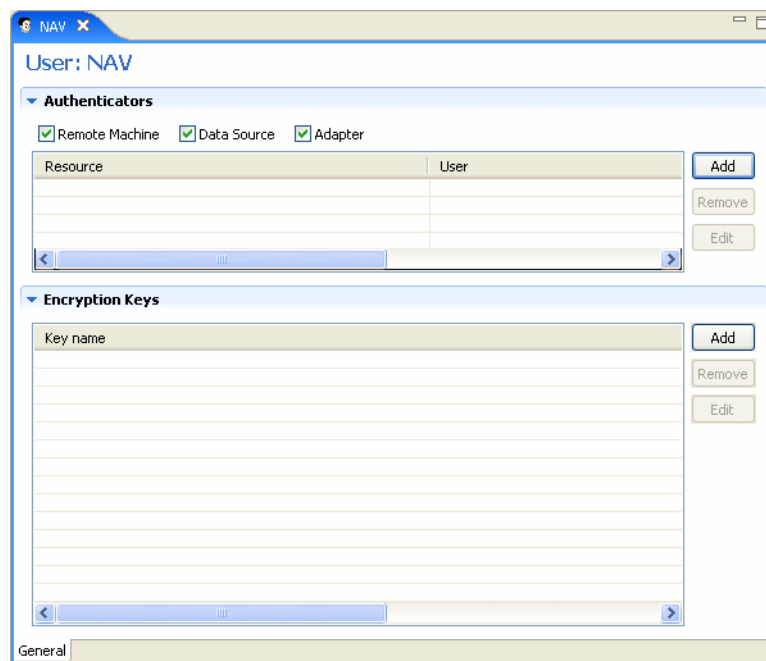

5. In the User editor, click **Add**. The Add Authenticator screen is displayed :

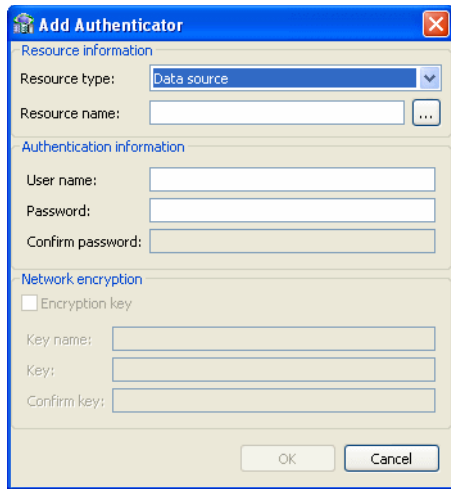
Figure 2–6 The Add Authenticator screen

6. Select **Remote Machine** from the Resource Type list.
7. Enter the name of the IBM z/OS computer defined in Oracle Studio.
8. Enter the name and password used to access the computer and confirm the password.
9. Click **OK**.

2.3 Setting up Metadata for the OracleAS VSAM Data Source

Setting up a change data capture with the OracleAS CDC Adapter for VSAM and VSAM under CICS is done using Oracle Studio. The first step is to define a VSAM or VSAM (CICS) data source and import the metadata. The definitions are created on a z/OS computer.

Note: The type of VSAM data source that you select depends whether you are working under CICS. If you are working under CICS you must select a VSAM (CICS) data source and also select VSAM (CICS) when [Setting Up a Change Data Capture with the OracleAS CDC Adapter for VSAM](#).

This section contains the following:

- [Setting Up the VSAM Data Source](#)
- [Configuring the Data Source Driver](#)
- [Importing Metadata for the VSAM Data Source](#)
- [Verifying the Metadata Definition](#)

2.3.1 Setting Up the VSAM Data Source

You should configure a VSAM data source as the first step in setting up the CDC adapter.

Perform the following steps to set up the VSAM data source:

1. From the **Start** menu, select **Programs, Oracle** and then select **Studio**.

2. In the Design perspective, Configuration view expand the **Machines** folder.
3. Expand the machine defined in [Setting Up the IBM z/OS Platform in Oracle Studio](#).
4. Expand the **Bindings** folder. The binding configurations available on this computer are listed.
5. Expand the **NAV** binding. The NAV binding configuration includes branches for data sources and adapters that are located on the computer.
6. Right-click **Data sources** and select **New Data source**.
The New Data Source wizard is displayed.

Figure 2–7 The New Data Source screen

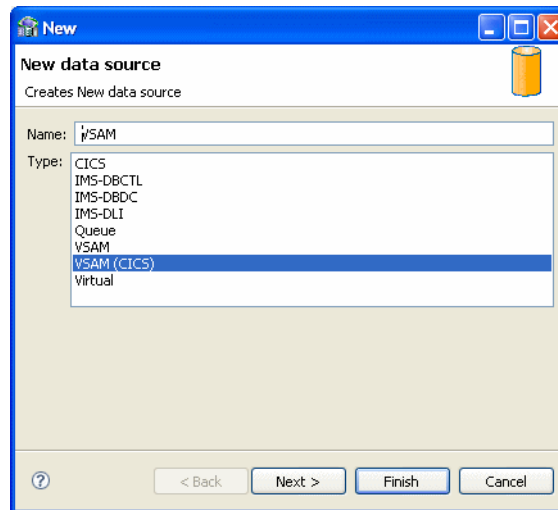

7. Enter a name for the VSAM data source. The name can contain letters and numbers and the underscore character only.
8. In the Type field, select **VSAM (CICS)** or **VSAM**.
9. Click **Next**. The **Data Source Connect String** screen is displayed.
10. Enter the parameters for the Data source connect string.

If you are using a VSAM (CICS) data source, enter information for the following parameters:

- **CICS Application ID:** The VTAM applid of the CICS target system. The default value is CICS. This parameter is used when updating VSAM data. You can determine this value by activating the CEMT transaction on the target CICS system. On the bottom right corner of the screen appears the legend `APPLID=target_system`.
- **Transaction ID:** The mirror transaction within CICS that receives control through MRO, which transfers the transaction from the Oracle Connect for VSAM environment to CICS. The default value is EXCI.
- **VTAM NetName:** The VTAM netname of the specific connection being used by EXCI (and MRO) to relay the program call to the CICS target system. For example, if you issue to CEMT the following command:

```
CEMT INQ CONN
```

The display screen displays the netname `BATCHCLI` (this is the default connection supplied by IBM upon the installation of CICS). The default value is `ATYCLIEN`.

- **Program Name:** The `UPDTRNS` program that is supplied by Oracle Connect for VSAM to enable updating VSAM data.
- **Trace Queue:** The name of queue for output which is defined under CICS when tracing the output of the `UPDTRNS` program. When not defined, the default CICS queue is used.

If you are using a VSAM data source, enter information for the following parameters:

- **Data HLQ:** The high-level qualifier where the data files are located.
- **Disk Volume Name:** The high-level qualifier (volume) where the data resides. The values specified are used in the Data File field in the Oracle Studio Design perspective, Metadata tab. For tables created using the `CREATE TABLE` statement, the values specified are used to create the data files. If values are not specified, then data files are written to the `DEF` high-level qualifier under the high-level qualifier where Oracle Connect is installed.

When SMS is used to manage the volumes, leave this value empty and set the `newFileSMSStorageClass` and `newFileSMSDataClass` properties as described in [VSAM Properties](#).

11. Click **Finish**.

The new data source is displayed in the Configuration Explorer.

2.3.2 Configuring the Data Source Driver

After setting up the VSAM data source, you can set its driver properties according to specific requirements. To edit the properties:

1. In the Configuration view, right-click the VSAM data source that you created and select **Open**.
2. Click the **Configuration** tab.

The VSAM or VSAM (CICS) data source configuration is displayed in the editor. This editor has two sections.

The **Connection** section shows the connections you defined when [Setting Up the VSAM Data Source](#).

The **Properties** section displays the properties that can be configured for the data source. For a list of the properties, see the following:

- [VSAM \(CICS\) Properties](#)
 - [VSAM Properties](#)
 - [Configuring the Data Source Driver Advanced Properties](#)
3. Click **Save** to save the changes you made to the configuration properties.

2.3.2.1 VSAM (CICS) Properties

The following properties can be configured for the VSAM (CICS) data source. You set the properties in Oracle Studio, Design perspective.

- `allowUpdateKey`: When set to `true`, this parameter specifies that the key is updatable.
- `disableExplicitSelect`: When set to `true`, this parameter disables the `ExplicitSelect ADD` attribute; every field is returned by a `SELECT * FROM . . .` statement.
- `trigger`: A name of a user defined trigger or user exit that can be set up. User code is activated on specific events such as `PRE-UPDATE` and `POST-READ`. Triggers are normally used for either compression/decompression code or advanced logic for filtering.

2.3.2.2 VSAM Properties

The following properties can be configured for the VSAM data source. You set the properties in Oracle Studio, Design perspective. For information on how to set data source properties in Oracle Studio.

- `disableExplicitSelect`: When set to `true`, this parameter disables the `ExplicitSelect ADD` attribute; every field is returned by a `SELECT * FROM . . .` statement.
- `filepoolCloseOnTransaction`: This parameter specifies that all files in the file pool for this data source close at each end of transaction (commit or rollback).
- `filepoolSize`: This parameter specifies how many instances of a file from the file pool may be open concurrently.
- `newFileSMSStorageClass`: This parameter specifies the storage class when SMS is used to manage volumes.
- `newFileSMSDataClass`: This parameter specifies the data class when SMS is used to manage volumes.
- `trigger`: A name of a user defined trigger or user exit that can be set up. User code is activated on specific events, such as `PRE-UPDATE` and `POST-READ`. Triggers are normally used for either compression/decompression code or advanced logic for filtering.
- `useGlobalFilepool`: This parameter specifies whether a global file pool that can span multiple sessions is used.

2.3.2.3 Configuring the Data Source Driver Advanced Properties

You configure the advanced properties for a data source in the **Advanced** tab of the data source editor. The advanced settings are the same for every data source. Advanced settings let you do the following:

- Define the transaction type
- Edit the syntax name
- Provide a table owner
- Determine if a data source is updatable or readable
- Provide repository information
- Set the virtual view policy

Use the following procedure to configure the data source advanced features.

1. Open Oracle Studio.

2. In the Design Perspective Configuration View, expand the **Machine** folder and then expand the machine where you want to configure the data source.
3. Expand the **Data sources** folder, right click the data source you are configuring, then select Open.
4. Click the **Advanced** tab and make the changes. The table below describes the available fields:

Table 2-1 Data Source Advanced Configuration

Field	Description
Properties	
Transaction type	The transaction level (0PC, 1PC or 2PC) that is applied to this data source, no matter what level the data source supports. The default is the data source's default level.
Syntax name	<p>A section name in the NAV.SYN file that describes SQL syntax variations. The default syntax file contains the following predefined sections:</p> <ul style="list-style-type: none"> ■ OLESQL driver and the SQL Server 7 OLE DB provider (SQLOLEDB): syntaxName="OLESQL_SQLOLEDB" ■ OLESQL driver and JOLT: syntaxName="OLESQL_JOLT" ■ Rdb driver and Rdb version: syntaxName="RDBS_SYNTAX" ■ ODBC driver and EXCEL data: syntaxName="excel_data" ■ ODBC driver and SQL/MX data: syntaxName="SQLMX_SYNTAX" ■ ODBC driver and SYBASE SQL AnyWhere data: syntaxName="SQLANYS_SYNTAX" ■ Oracle driver and Oracle case sensitive data: syntaxName="ORACLE8_SYNTAX" or, syntaxName="ORACLE_SYNTAX" <p>For case sensitive table and column names in Oracle, use quotes (") to delimit the names. Specify the case sensitivity precisely.</p>
Default table owner	The name of the table owner that is used if an owner is not indicated in the SQL
Read/Write information	<p>Select one of the following:</p> <ul style="list-style-type: none"> ■ Updatable data: Select this to update the data on the data source. ■ Read only data: Select this to allow users to only view the data on the data source.
Repository Directory	
Repository directory	Enter the location for the data source repository.

Table 2–1 (Cont.) Data Source Advanced Configuration

Field	Description
Repository name	Enter the name of a repository for a data source. The name is defined as a data source in the binding configuration. It is defined as the type <code>Virtual</code> and is used to store Oracle Connect views and stored procedures for the data source, if required instead of using the default SYS data.
Virtual View Policy	
Generate sequential view	Select this to map a non-relation file to a single table. This parameter is valid only if you are using virtual array views. You configure virtual array views in the Modeling section of the when Configuring a Binding Environment .
Generate virtual views	Select this to have an individual table created for every array in the non-relational file. This parameter is valid only if you are using virtual array views. You configure virtual array views in the Modeling section when Configuring a Binding Environment .
Include row number column	Select this to include a column that specifies the row number in the virtual or sequential view. This parameter is valid only if you are using virtual array views. You configure virtual array views in the Modeling section when Configuring a Binding Environment .
All parent columns	Select this for virtual views to include all the columns in the parent record. This parameter is valid only if you are using virtual array views. You configure virtual array views in the Modeling section when Configuring a Binding Environment .

2.3.3 Importing Metadata for the VSAM Data Source

Oracle Connect requires metadata describing the VSAM data source records and the fields in these records. Use the Import Metadata procedure in Oracle Studio to import metadata for the VSAM data source from COBOL copybooks, which describe the data.

The metadata import procedure is has the following steps:

- [Select the COBOL Copybooks](#)
- [Applying Filters](#)
- [Selecting Tables](#)
- [Import Manipulation](#)
- [Create VSAM Indexes](#) (VSAM Batch only)
- [Assigning File Names](#) (VSAM under CICS only)
- [Assigning Index File Names](#) (VSAM under CICS only)
- [Metadata Model Selection](#)
- [Importing the Metadata](#)

2.3.3.1 Select the COBOL Copybooks

Perform the following steps to select the COBOL copybooks.

1. From the **Start** menu, select **Programs, Oracle**, and then select **Studio**.
2. In the Design perspective, Configuration view expand the **Machines** folder.
3. In the Design perspective Configuration view, expand the machine defined in [Setting Up the IBM z/OS Platform in Oracle Studio](#).

4. Expand **Bindings** folder. The binding configurations available on this computer are listed.
5. Expand the **NAV** binding.
6. Expand the **Data sources** folder.
7. Right-click the VSAM data source defined in [Setting Up the VSAM Data Source](#).
8. Select **Show Metadata View** to open the Metadata tab, with the VSAM data source displayed under the data sources list.
9. Right-click the VSAM data source and select **New Import**.
The New Import screen is displayed.
10. Enter a name for the import. The name can contain letters and numbers and the underscore character only.
11. Select the import type from the Import Type list, as shown in the following figure:

Figure 2–8 The Metadata Import screen

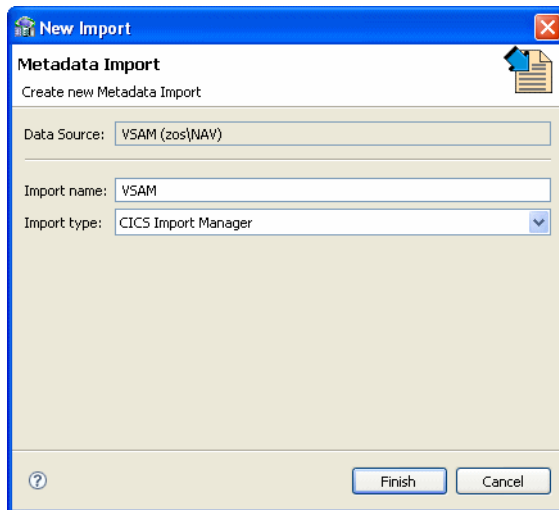

Note: The same New Import screen is displayed for both VSAM imports (VSAM under CICS and VSAM direct), except for the Import type field value: either VSAM Under CICS Import Manager or VSAM Import Manager, respectively)

12. Click **Finish**. The Get Input Files screen is displayed.

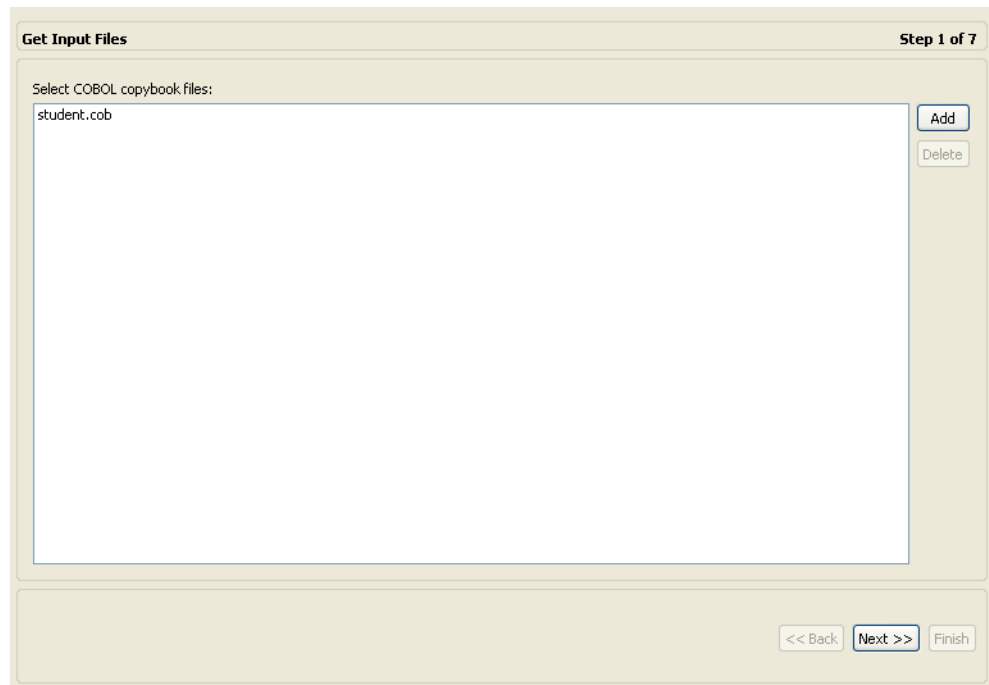
Figure 2–9 The Get Input Files screen**13. Click Add.**

The Select Resources screen is displayed, which provides the option to select files from the local computer or copy the files from another computer.

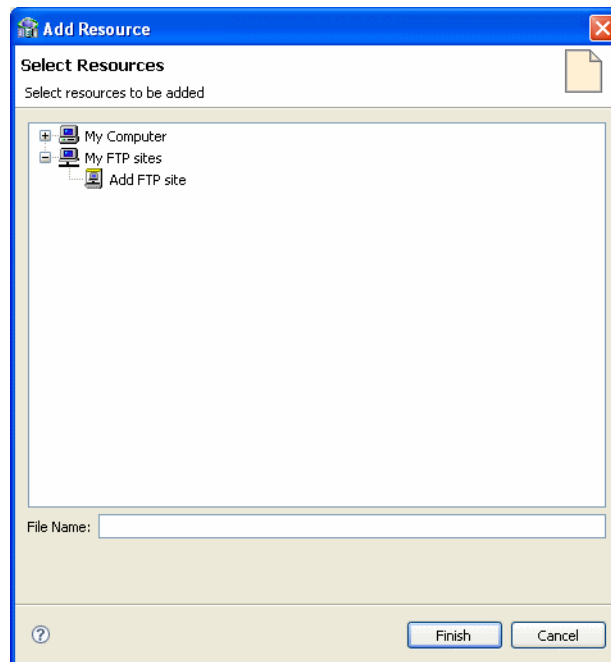
Figure 2–10 The Add Resource screen**14. If the files are on another machine, then right-click My FTP Sites and select Add.**

The Add FTP Site screen is displayed. Enter the correct information to connect to the FTP site.

15. Enter the server name where the COBOL copybooks are located and, if not using anonymous access, enter a valid user name and password to access that computer. The user name is then used as the high-level qualifier.
16. Click **OK**. After accessing the remote computer, you can change the high-level qualifier by right-clicking the machine in the Add Resource screen, and selecting **Change Root Directory**.
17. Select the files to import and click **Finish** to start the file transfer. When complete, the selected files are displayed in the Get Input Files screen.
To remove any of these files, select the required file and click **Remove**.
18. Click **Next** (The Apply Filters screen opens) to continue to the [Applying Filters](#) step.

2.3.3.2 Applying Filters

This section describes the steps required to apply filters on the COBOL copybooks used to generate the Metadata. It continues the [Select the COBOL Copybooks](#) procedure. Do the following to apply filters:

1. Expand all in the Apply Filters screen.
2. Apply the required filter attributes to the COBOL copybooks. The available filters are listed and described in the table that describes the [Metadata Filters](#).
3. Click **Next** (The Select Tables screen opens) to continue to the [Selecting Tables](#) step.

This figure shows the Apply Filters screen.

Figure 2–11 The Apply Filters screen

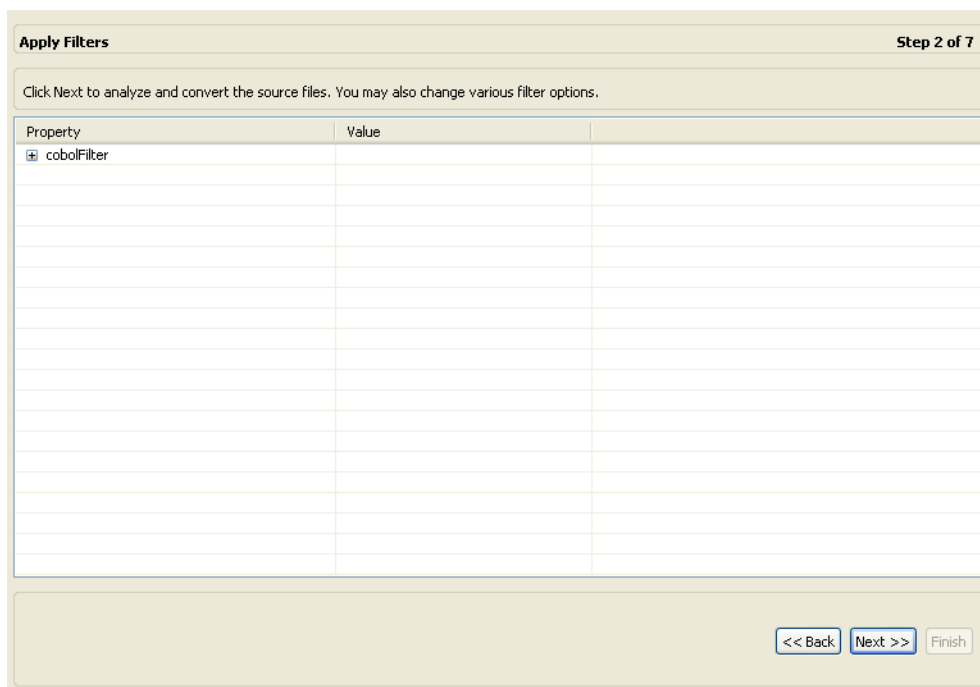

The following table lists the available filters:

Table 2–2 Metadata Filters

Filter	Description
COMP_6 switch	The MicroFocus COMP-6 compiler directive. Specify either COMP-6'1' to treat COMP-6 as a COMP data type or COMP-6'2' to treat COMP-6 as a COMP-3 data type.
Compiler source	The compiler vendor. The following are available: <ul style="list-style-type: none"> ■ z/OS ■ AS400 ■ HP NonStop ■ VMS ■ MICROFOCUS ■ Hardware (UNIX vendor) ■ Default/Not known/Other
Storage mode	The MicroFocus Integer Storage Mode. Select one of the following: <ul style="list-style-type: none"> ■ NOIBMCOMP for byte storage mode. ■ IBMCOMP for word storage mode.
Ignore after column 72	When set to <code>true</code> , ignores columns 73 to 80 in the COBOL copybook.
IgnoreFirst6	When set to <code>true</code> , ignores the first six columns in the COBOL copybook.
Replace hyphens (-) in record and field names with underscores (_)	When set to <code>true</code> , replaces all hyphens in either the record or field names in the metadata generated from the COBOL with underscore characters.
Prefix nested columns	When set to <code>true</code> , prefix all nested columns with the previous level heading.
Case sensitive	Specifies whether to be sensitive to the search string case.
Find	Searches for the specified value.
Replace with	Replaces the value specified for Find with the value specified here

2.3.3.3 Selecting Tables

This section describes the steps required to select the tables from the COBOL copybooks. The import manager identifies the names of the records in the COBOL copybooks that are imported as tables.

Do the following to select the required tables. This continues the [Applying Filters](#) procedure.

1. From the Select Tables screen, select the tables to access. To select all tables, click **Select All**. To deselect all selected tables, click **Unselect All**.

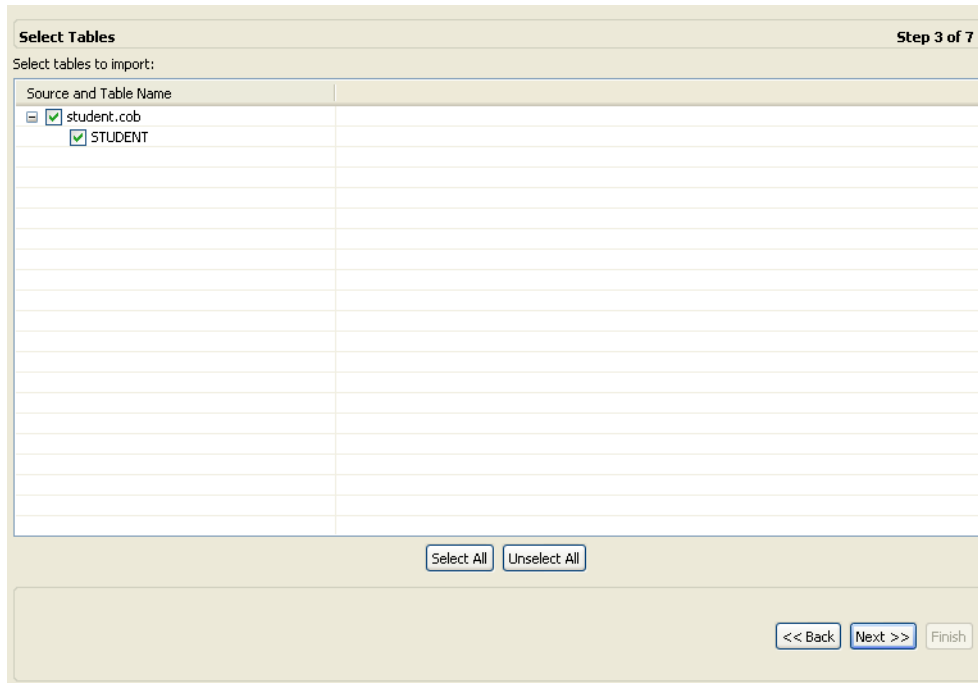
Figure 2–12 The Select Tables screen

2. Click **Next** (the Import Manipulation screen opens) to continue to the [Import Manipulation](#) step.

2.3.3.4 Import Manipulation

This section describes the operations available for manipulating the imported records (tables). It continues the [Selecting Tables](#) procedure.

The import manager identifies the names of the records in the DDM Declaration files that are imported as tables. You can manipulate the general table data in the [Import Manipulation Screen](#). The following describes how to manipulate the records in the tables.

1. From the Import Manipulation screen (see the [Import Manipulation Screen](#) figure), right-click the table record marked with a validation error, and select the relevant operation. For more information, see the table, [Table Manipulation Options](#) for the available operations.
2. Repeat step 1 for all table records marked with a validation error. You resolve the issues in the [Import Manipulation Screen](#).

Once all the validation error issues have been resolved, the Import Manipulation screen is displayed with no error indicators.

3. Click **Next**.

If you are importing metadata for a VSAM data source, continue to the [Create VSAM Indexes](#) step.

If you are importing metadata for a VSAM (CICS) data source, continue to the [Assigning File Names](#) step.

Import Manipulation Screen

The Import Manipulation screen is shown in the following figure:

Figure 2–13 Import Manipulation Screen

!	Table Name	Metadata Source	Data Location
i	STUDENT	student.cob	

Validation Log

i Data location not defined

<< Back Next >> Finish

The upper area of the screen lists the COBOL files and their validation status. The metadata source and location are also listed.

The **Validation** tab at the lower area of the screen displays information about what must be resolved to validate the tables and fields generated from the COBOL. The **Log** tab displays a log of what has been performed (such as renaming a table or specifying a data location).

The following operations are available in the Import Manipulation screen:

- Resolving table names, where tables with the same name are generated from different files during the import.
- Selecting the physical location for the data.
- Selecting table attributes.
- Manipulating the fields generated from the COBOL, as follows:
 - Merging sequential fields into one (for simple fields).
 - Resolving variants by either marking a selector field or specifying that only one case of the variant is relevant.
 - Adding, deleting, hiding, or renaming fields.
 - Changing a data type.
 - Setting the field size and scale.
 - Changing the order of the fields.
 - Setting a field as nullable.
 - Selecting a counter field for array for fields with dimensions (arrays). You can select the array counter field from a list of potential fields.

- Setting column-wise normalization for fields with dimensions (arrays). You can create new fields instead of the array field where the number of generated fields are determined by the array dimension.
- Creating arrays and setting the array dimension.

The following table lists and describes the available operations when you right-click a table entry:

Table 2–3 Table Manipulation Options

Option	Description
Fields Manipulation	Customizes the field definitions, using the Field Manipulation screen. You can also access this screen by double-clicking the required table record.
Rename	Renames a table. This option is used especially when multiple tables with the same name are generated from the COBOL.
Set data location	Sets the physical location of the data file for the table.
Set table attributes	Sets the table attributes.
XSL manipulation	Specifies an XSL transformation or JDOM document that is used to transform the table definitions.
Remove	Removes the table record.

You can manipulate the data in the table fields in the [Import Manipulation Screen](#). Double-click a line in the Import Manipulation Screen to open the Field Manipulation Screen.

Field Manipulation Screen

The Field Manipulation screen lets you make changes to fields in a selected table. You get to the Field Manipulation screen through the [Import Manipulation Screen](#). The Field Manipulation screen is shown in the following figure.

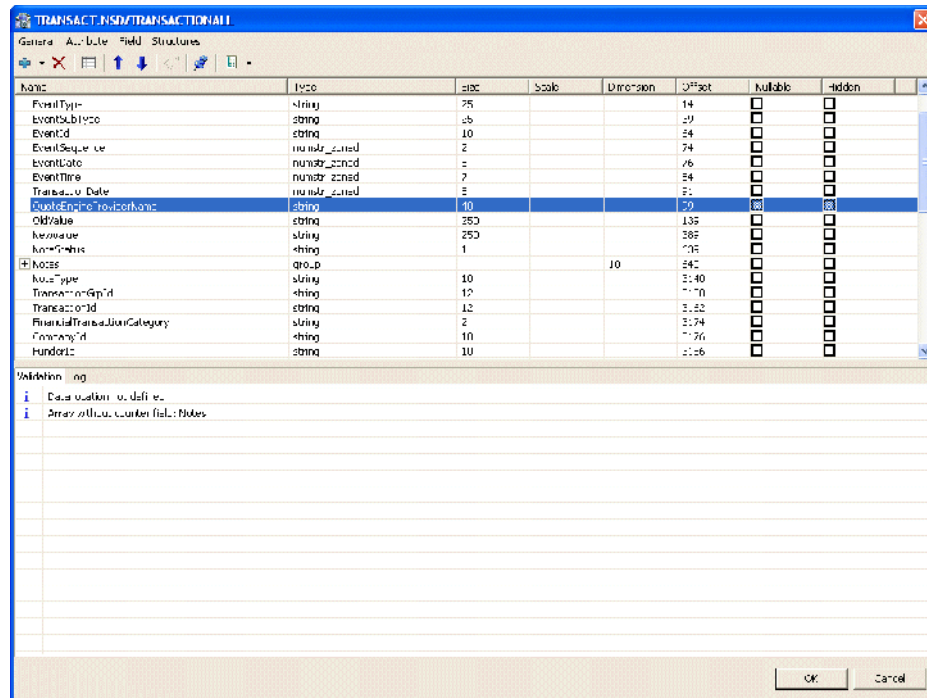
Figure 2–14 Field Manipulation Screen

You can perform all of the available tasks in this screen through the menu or toolbar. You can also right click anywhere in the screen and select any of the options available in the main menus from a shortcut menu. The following table describes the tasks that are done in this screen. If a toolbar button is available for a task, it is pictured in the table.

Table 2–4 Field Manipulation Screen Commands



Command	Description
General menu	
Undo	Click to undo the last change made in the Field Manipulation screen.
	
Select fixed offset	The offset of a field is usually calculated dynamically by the server at run time according the offset and size of the proceeding column. Select this option to override this calculation and specify a fixed offset at design time. This can happen if there is a part of the buffer to skip.
	
	When you select a fixed offset you pin the offset for that column. The indicated value is used at run time for the column instead of a calculated value. Note that the offset of following columns that do not have a fixed offset are calculated from this fixed position.

Table 2–4 (Cont.) Field Manipulation Screen Commands

Command	Description
---------	-------------

Test import tables



Select this table to create an SQL statement to test the import table. You can base the statement on the **Full table** or **Selected columns**. When you select this option, the following screen opens with an SQL statement based on the table or column entered at the bottom of the screen.

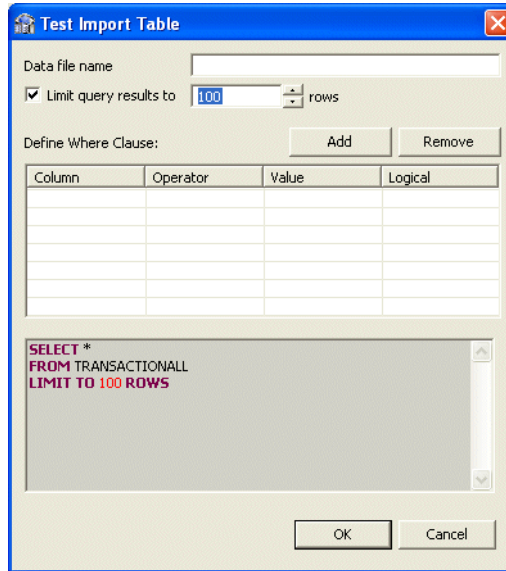

Enter the following in this screen:

- **Data file name:** Enter the name of the file that contains the data you want to query.
- **Limit query results:** Select this to limit the results to a specified number of rows. Enter the amount of rows you want returned in the following field. 100 is the default value.
- **Define Where Clause:** Click **Add** to select a column to use in a Where clause. In the table in the middle of the screen, you can add the operator, value and other information. Click the columns to make the selections. To remove a Where Clause, select the row with the Where Clause you want to remove and then click **Remove**.

The resulting SQL statement with any Where Clauses that you added are displayed at the bottom of the screen.

Click **OK** to send the query and test the table.

Attribute menu

Change data type

Select **Change data type** from the **Attribute** menu to activate the **Type** column, or click the **Type** column and select a new data type from the list.

Table 2-4 (Cont.) Field Manipulation Screen Commands





Command	Description
Create array	This command lets you add an array dimension to the field. Select this command to open the Create Array screen.
	
	Enter a number in the Array Dimension field and click OK to create the array for the column.
Hide/Reveal field	Select a row from the Field manipulation screen and select Hide field to hide the selected field from that row. If the field is hidden, you can select Reveal field .
Set dimension	Select this to change or set a dimension for a field that has an array. Select Set dimension to open the Set Dimension screen. Edit the entry in the Array Dimension field and click OK to set the dimension for the selected array.
Set field attribute	Select a row to set or edit the attributes for the field in the row. Select Set field attribute to open the Field Attribute screen.
	
	Click in the Value column for any of the properties listed and enter a new value or select a value from a list.
Nullable/Not nullable	Select Nullable to activate the Nullable column in the Field Manipulation screen. You can also click in the column. Select the check box to make the field Nullable. Clear the check box to make the field Not Nullable.
Set scale	Select this to activate the Scale column or click in the column and enter the number of places to display after the decimal point in a data type.
Set size	Select this to activate the Size column or click in the column and enter the number of total number of characters for a data type.
Field menu	

Table 2–4 (Cont.) Field Manipulation Screen Commands

Command	Description
<p>Add</p> 	<p>Select this command or use the button to add a field to the table. If you select a row with a field (not a child of a field), you can add a child to that field. Select Add Field or Add Child to open the following screen:</p>  <p>Enter the name of the field or child, and click OK to add the field or child to the table.</p>
<p>Delete field</p> 	<p>Select a row and then select Delete Field or click the Delete Field button to delete the field in the selected row.</p>
<p>Move up or down</p> 	<p>Select a row and use the arrows to move it up or down in the list.</p>
<p>Rename field</p>	<p>Select Rename field to make the Name field active. Change the name and then click outside of the field.</p>
<p>Structures menu</p>	
<p>Columnwise Normalization</p>	<p>Select Columnwise Normalization to create new fields instead of the array field where the number of generated fields are determined by the array dimension.</p>
<p>Combining sequential fields</p>	<p>Select Combining sequential fields to combine two or more sequential fields into one simple field. The following dialog box opens:</p>

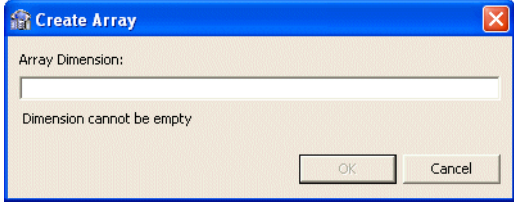
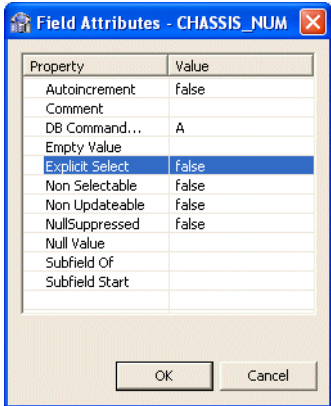

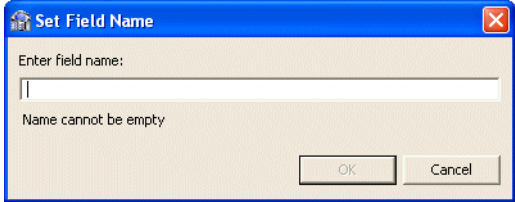
Enter the following information in the Combining sequential fields screen:

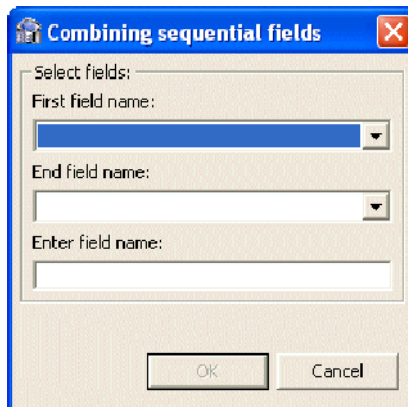
- **First field name:** Select the first field in the table to include in the combined field
- **End field name:** Select the last field to be included in the combined field. Ensure that the fields are sequential.
- **Enter field name:** Enter a name for the new combined field.

Table 2–4 (Cont.) Field Manipulation Screen Commands

Command	Description
Flatten group	Select Flatten Group to flatten a field that is an array. This field must be defined as <code>Group</code> for its data type. When you flatten an array field, the entries in the array are spread into a new table, with each entry in its own field. The following screen provides options for flattening.



Do the following in this screen:

- Select **Recursive operation** to repeat the flattening process on all levels. For example, if there are multiple child fields in this group, you can place the values for each field into the new table when you select this option.
- Select **Use parent name as prefix** to use the name of the parent field as a prefix when creating the new fields. For example, if the parent field is called `Car Details` and you have a child in the array called `Color`, when a new field is created in the flattening operation, it is called `Car Details_Color`.

Mark selector

Select **Mark selector** to select the selector field for a variant. This is available only for variant data types. Select the **Selector** field from the following screen.

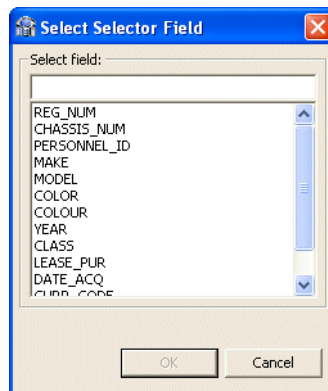

Replace variant

Select **Replace variant** to replace a variant's selector field.

Table 2–4 (Cont.) Field Manipulation Screen Commands

Command	Description
Select counter field	Select Counter Field opens a screen where you select a field that is the counter for an array dimension.

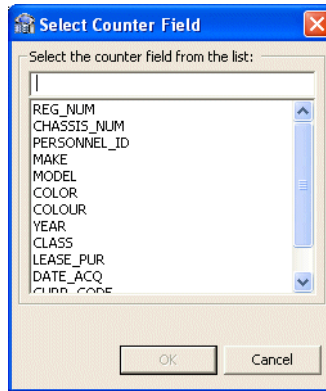

2.3.3.5 Create VSAM Indexes

This wizard page is used to create VSAM indexes. It is valid only for VSAM data sources. If you are using a VSAM CICS data sources, go to the [Assigning File Names](#) step. This step continues the [Import Manipulation](#) step.

This figure shows the Create VSAM Indexes step.

Figure 2–15 Create Indexes (For VSAM (ADD) only)

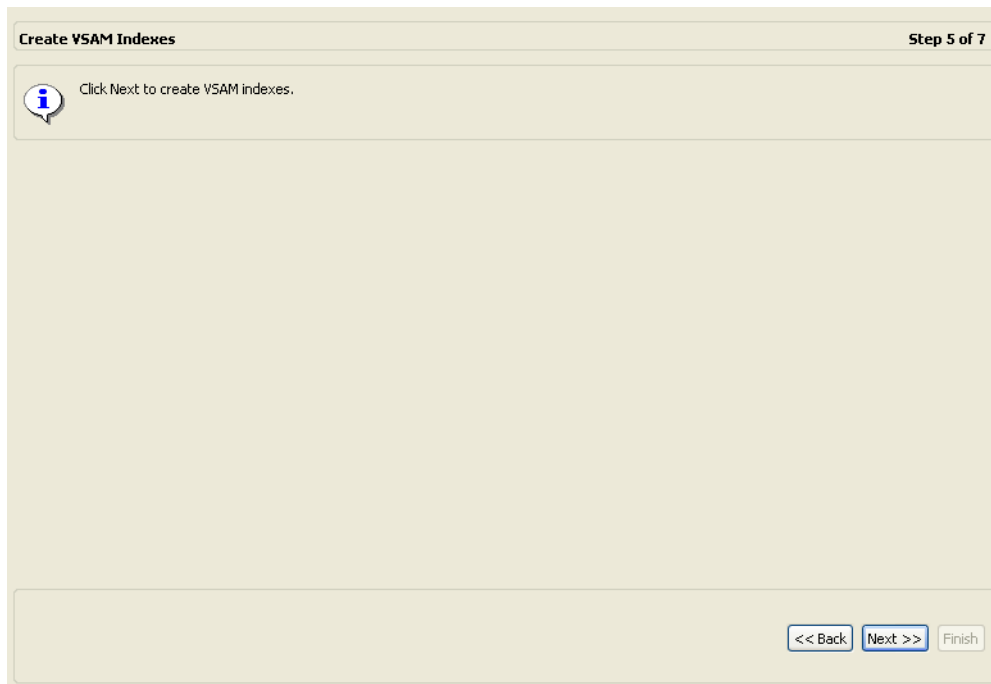

To create VSAM Indexes

- Click **Next** to go to the [Metadata Model Selection](#) step. The indexes are created automatically.

This figure shows the Assign Index File Names screen.

Figure 2–17 The Assign Index File Names screen

The screenshot shows a web-based interface titled "Assign Index File Names" with a progress indicator "Step 6 of 8". Below the title, it says "Click Next to assign the index file names." There is a table with two columns: "Physical Name" and "Logical Name". The table is currently empty. At the bottom right of the interface, there are three buttons: "<< Back", "Next >>", and "Finish".

2.3.3.8 Metadata Model Selection

This section lets you generate virtual and sequential views for imported tables containing arrays. In addition, you can configure the properties of the generated views. It continues the [Create VSAM Indexes](#) step if you are using a VSAM data source or it continues the [Assigning Index File Names](#) procedure if you are using a VSAM CICS data source. This step lets you flatten tables that contain arrays.

In the Metadata Model Selection step, you can select configure values that apply to all tables in the import or set specific settings for each table. Do the following to configure the metadata model.

- Select *one* of the following:
 - **Default values for all tables:** Select this to configure the same values for all the tables in the import. Make the following selections when using this option:
 - **Generate sequential view:** Select this to map non-relational files to a single table.
 - **Generate virtual views:** Select this to have individual tables created for each array in the non-relational file.
 - **Include row number column:** Select *one* of the following:
 - true:** Select **true**, to include a column that specifies the row number in the virtual or sequential view. This is true for this table only, even if the data source is not configured to include the row number column.
 - false:** Select **false**, to not include a column that specifies the row number in the virtual or sequential view for this table even if the data source is configured to include the row number column.

default: Select **default** to use the default data source behavior for this parameter.

- **Inherit all parent columns:** Select *one* of the following:

true: Select **true**, for virtual views to include all the columns in the parent record. This is true for this table only, even in the data source is not configured to include all of the parent record columns.

false: Select **false**, so virtual views do not include the columns in the parent record for this table even if the data source is configured to include all of the parent record columns.

default: Select **default** to use the default data source behavior for this parameter.

- **Specific virtual array view settings per table:** Select this to set different values for each table in the import. This overrides the data source default for that table. Make the selections in the table under this selection.

When you are finished configuring the metadata model, click **Next** to go to the [Importing the Metadata](#) procedure.

The Metadata Model Selection screen is shown in the following figure:

Figure 2–18 The Metadata Model Selection Screen

Metadata Model Selection Step 6 of 7

Default values for all tables

Sequential View

Virtual Views

Virtual views include row number

Virtual views inherit all parent columns

Specific virtual array view settings per table

Table Name	Sequential View	Virtual Views	Row Number C...	Inherit all Pare...
STUDENT	<input checked="" type="checkbox"/>	<input checked="" type="checkbox"/>	true	true

2.3.3.9 Importing the Metadata

This section describes the steps required to import the metadata to the target computer. It continues the [Metadata Model Selection](#) step.

You can now import the metadata to the computer where the data source is located, or import it later (in case the target computer is not available).

Note: To update the metadata using the VSAM data source, and then access the data under CICS, you must:

- Close the file in CICS
 - Make the updates in with the VSAM data source
 - Exit navcmd. This closes the file in VSAM
 - Return to CICS and open the file there. The data should be available and you can now read the file.
-
-

Do the following to import the metadata.

1. Select **Yes** to transfer the metadata to the target computer or **No** to transfer the metadata later.
2. Click **Finish**.

If you specified **Yes**, then the metadata is imported to the target computer immediately.

The Import Metadata screen is shown in the following figure:

Figure 2–19 *The Import Metadata screen*

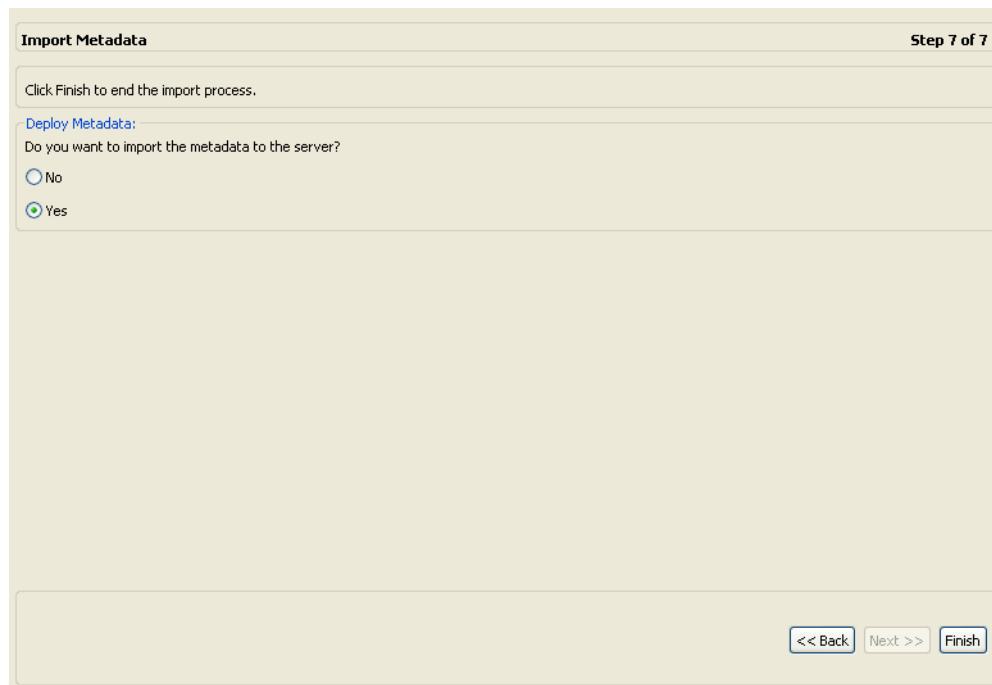

After performing the import, you can view the metadata in the Metadata tab in Oracle Studio. You can also make any fine adjustments to the metadata and maintain it, as necessary.

2.3.4 Verifying the Metadata Definition

After you finish [Importing Metadata for the VSAM Data Source](#), you must verify that the metadata is correct. Do the following to verify that the metadata was imported correctly.

1. From the **Start** menu, select **Programs, Oracle** and then select **Studio**.
2. In the Design perspective, Configuration view expand the **Machines** folder.
3. Expand the machine defined in [Setting Up the IBM z/OS Platform in Oracle Studio](#).
4. Expand the **Bindings** folder. The binding configurations available on this computer are listed.
5. Expand the **NAV** binding. The NAV binding configuration includes branches for data sources and adapters that are located on the computer.
6. Expand the **Data Sources** folder.
7. Right-click the data source that you set up when [Setting Up the VSAM Data Source](#), and select **Show Metadata View**. The Metadata view opens with the data source you selected expanded.
8. Expand the **Tables** folder.
9. Right-click the table or tables where you carried out the metadata import and select **Test**. The Test wizard opens.
10. Click **Next** to view the metadata. The tables are displayed from the metadata. Check to see that the correct information is displayed.

2.4 Setting Up a Change Data Capture with the OracleAS CDC Adapter for VSAM

You must set up the Oracle Connect CDC adapter for VSAM on the z/OS platform to handle capture changes to the VSAM data.

To work with the VSAM under CICS CDC adapter, you must set up the CICS user journal on the z/OS computer. To work with the VSAM Batch adapter, you must set up the CDC Logger. After you finish making the required configurations on the z/OS computer, configure the change data capture using the Oracle Studio CDC Solution perspective. Oracle Studio must be installed on a Windows or UNIX computer

Perform the following to set up the change data capture and configure the OracleAS CDC Adapter for VSAM under CICS

- [Managing the CICS User Journal \(VSAM CICS Only\)](#)
- [Configuring the Logger \(VSAM Batch Only\)](#)
- [Setting up a Change Data Capture in Oracle Studio](#)
- [Deploying a Change Data Capture](#)

2.4.1 Managing the CICS User Journal (VSAM CICS Only)

The following are the tasks used for managing the VSAM CDC adapter:

- [Setting up the CICS User Journal for VSAM](#)
- [Print the CICS User Journal Content](#)

2.4.1.1 Setting up the CICS User Journal for VSAM

This section describes how to set up the CICS user journal for VSAM. Do the following to set up the CECS user journal for VSAM.

1. Check if a relevant CICS User Journal is available by entering the following CICS command:

```
CEMT I JO
```

This displays the list of all the available CICS Journals, for example:

```
Jou(DFHJ77) Mvs Ena Str(CICSTS13.CICS.DFHJ77)
Jou(DFHJ66) Mvs Ena Str(CICSTS13.CICS.DFHJ66)
Jou(DFHLOG) Mvs Ena Str(CICSTS13.CICS.DFHLOG)
...
```

Each User Journal has the CICS name DFHJxx, where xx is the number of the journal. You can use any of them as the CDC Logger. Its logstream name (for example, CICSTS13.CICS.DFHJ77) should be provided as CDC Logger Name property.

If you cannot use an available journal, go to steps 2 and 3. If you can use a journal in the list, go to step 4.

2. Create an MVS logstream that can be used as a CICS journal. A sample job for the creation of DASD MVS logstream called ORACLE.CDC.VSAMBTCH is supplied in the <HLQ>.USERLIB(LOGCRVSM) member. For more information, see IBM's MVS Setting Up a Sysplex manual.
3. Define and install the log stream as a user journal by entering the following CICS command:

```
CEDA DEF JO(<journal name>) GR(<CICS group name>) TY(MVS) STR(<logstream name>)
CEDA INST JO(journal name) GR((<CICS group name>))
```

4. For each VSAM cluster to be captured, use the CICS command CEDA DI FI, and edit the properties as shown in the following example:

```
+ JOURNAL : <journal number>
JNLRead : Updateonly
JNLSYNRead : Yes
JNLUpdate : Yes
JNLAdd : After
JNLSYNWrite : Yes
RECOVERY PARAMETERS
RECOVry : Backoutonly
Fwdrecovlog : No
BACKUPTYPE : Static
SECURITY
RESSECNUM : 00
```

The value JNLRead means that before images are also written to the journal. The value JNLSYNWrite means that CICS writes the changes to the journal immediately, instead of saving them in a buffer and writing them to the journal in blocks.

Close the VSAM cluster by using the following CICS command:

```
CEMT S F(<CICS file name>) CLOSE
```

Reinstall the cluster by using the following CICS command:

```
CEDA INST F(<CICS file name>) GR(<CICS group name>)
```

Open the cluster by using the following CICS command:

```
CEMT S F(<CICS file name>) OPEN
```

2.4.1.2 Print the CICS User Journal Content

You can print a CICS journal content running a job as described in the following example:

```
//PRINTLOG JOB 'RR', 'TTT', MSGLEVEL=(1,1), CLASS=C
```

```

// MSGCLASS=X,NOTIFY=&SYSUID
//PRNTJNL EXEC PGM=DFHJUP
//STEPLIB DD DSNAME=<HLQ>.SDFHLOAD,DISP=SHR
//SYSPRINT DD SYSOUT=A,DCB=RECFM=FBA
//SYSUT1 DD DSNAME=<logstream name>,
// DCB=BLKSIZE=32760,
// SUBSYS=(LOGR,DFHLGCV,
//
* 'FROM=(2003/261,22:07:16),TO=(2004/007,23:59:15),
LOCAL')
'FROM=(2003/261,22:07:16),TO=YOUNGEST,LOCAL')
/* 09/18/2003 22:07:15
/* 09/19/2003 15:35:34
//SYSIN DD *
*-----* CONTROL STATEMENT :
DEFAULTS *
* INPUT = SYSUT1 *
* OUTPUT = SYSPRINT *
* SELECTION QUALIFIERS : *
* 1. DEFAULT = ALL INPUT RECORDS *
*-----*
OPTION PRINT
END
*-----*
/*

```

where:

- DSNAME: This is the name of the journal logstream.
- FROM: This is the earliest change you want to print.
- TO: This is the latest change you want to print (TO=YOUNGEST prints all the entries up to the last change logged).

2.4.2 Configuring the Logger (VSAM Batch Only)

To use the OracleAS CDC Adapter for VSAM Batch solutions, perform the following:

- [Creating the Logstream](#)
- [Creating the CDC\\$PARM Data Set](#)
- [Updating Jobs and Scripts](#)

2.4.2.1 Creating the Logstream

A sample job for the creation of DASD MVS logstream called ORACLE.CDC.VSAMBTCH is supplied in the <HLQ>.USERLIB (LOGCRVSM) member. For additional information, see IBM's MVS Setting Up a Sysplex manual.

Managing the MVS Logstream

The ATYLOGR program provided is used to manage MVS logstreams. It has the following options:

- Delete all events
- Delete events to a specific time stamp
- Delete the newest events
- Print events between two time stamps
- Print all the events from the oldest to a specified time stamp

- Print all the events from the newest to a specified time stamp
- Print all the events

A sample job for managing the default VSAM Batch CDC MVS Logstream called `ORACLE.CDC.VSAMBTCH` is supplied in the `<HLQ>.USERLIB (RUNLOGR)` member.

2.4.2.2 Creating the CDC\$PARM Data Set

`CDC$PARM` is the name of the DD card used to configure the JRNAD and Logical Transaction Manager. It can be any QSAM data set or member with the `LRECL=80` definition. For example, you can build it as a member of the `<HLQ>.USERLIB` library.

The data set contains parameters, one per a line, according to the follow syntax:

```
<parameter name>=<parameter value>
```

The parameters and their valid values are described in [CDC\\$PARM Properties \(VSAM Batch Only\)](#).

The minimal set of the parameters for any solution can be taken from Project Information section of Deployment Summary screen of Oracle Studio Solution Perspective.

If the `CDC$PARM` data set is not provided to the JRNAD or Logical Transaction Manager, it is managed as follows:

```
DSNAME=*
LOGSTREAM=ORACLE.CDC.VSAMBTCH
```

2.4.2.3 Updating Jobs and Scripts

To ensure that the changes are captured, you must update the jobs and REXX scripts used to change the VSAM data.

- [Updating Jobs for Activating CDC JRNAD](#)
- [Updating Jobs for Using the Logical Transaction Manager](#)
- [Update the REXX Scripts](#)

Updating Jobs for Activating CDC JRNAD

To get the CDC JRNAD program that is being called, add three DD cards to each step that activates a program that is being updated, as shown in this example:

```
STEPLIB DD DSN=<HLQ>.LOADCDCY,DISP=SHR
ATYLIB DD DSN=<HLQ>.LOADAUT,DISP=SHR
CDC$PARM DD DSN=<CDC$PARM DS name>,DISP=SHR
```

Ensure that that the `<HLQ>.LOADAUT` load library is APF authorized.

Updating Jobs for Using the Logical Transaction Manager

To use the Logical Transaction manager, add additional steps to the jobs used as a part of the logical transaction.

- Start a Logical Transaction: To begin a logical transaction, add the following step as the first step in a job:

```
//BEGINLT EXEC PGM=ATYLTRAN,
// PARM='BEGIN,TRAN_NAME=<logical transaction name>'
//STEPLIB DD DSN=<HLQ>.LOADAUT,DISP=SHR
//CDC$PARM DD DSN=<CDC$PARM DS name>, DISP=SHR
```

- Move a Logical Transaction to another job: To move a logical transaction to another job, add the following step as the last step of the job:

```
//MOVELT EXEC PGM=ATYLTRAN,COND=(4,LT)
//STEPLIB DD DSN=<HLQ>.LOADAUT,DISP=SHR
//CDC$PARG DD DSN=<CDC$PARG DS name>, DISP=SHR
```

- **Continue Logical Transaction:** To continue a logical transaction in another job, add the following step as the first step of this job:

```
//CONTLT EXEC PGM=ATYLTRAN,
// PARM='TRAN_NAME='<logical transaction name>'
//STEPLIB DD DSN=<HLQ>.LOADAUT,DISP=SHR
//CDC$PARG DD DSN=<CDC$PARG DS name>, DISP=SHR
```

- **Terminate Logical Transaction:** To terminate a logical transaction, add the following two steps as the last steps of this job:

```
//COMMITLT EXEC PGM=ATYLTRAN,COND=(4,LT),
// PARM='COMMIT'
//STEPLIB DD DSN=<HLQ>.LOADAUT,DISP=SHR
//CDC$PARG DD DSN=<CDC$PARG DS name>, DISP=SHR
//RLBCKLT EXEC PGM=ATYLTRAN,COND=(EVEN,(0,EQ,COMMIT))
// PARM='ROLLBACK'
//STEPLIB DD DSN=<HLQ>.LOADAUT,DISP=SHR
//CDC$PARG DD DSN=<CDC$PARG DS name>, DISP=SHR
```

The COND clause in the COMMITLT step should provide the condition when the Logical Transaction terminates successfully by COMMIT. The COND clause in the RLBCKLT step always writes a ROLLBACK to the logstream when COMMITLT is not executed or fails.

Update the REXX Scripts

If you use REXX scripts to run VSAM update programs, you should change them for this purpose. The member NVCMDCDC in <HLQ>.USERLIB is supplied as an example of a REXX script.

2.4.3 Setting up a Change Data Capture in Oracle Studio

You set up the change data capture in Oracle Studio. Oracle Studio can be installed on Windows XP or Vista operating systems, or on UNIX.

A change data capture is defined in the CDC Solution perspective, which contains a series of links to guide you through the CDC set up process. The CDC solution perspective guides display the following symbols in front of a link to show you what tasks should be done, and what tasks were completed.

- **Triangle:** This indicates that there are subtasks associated with this link. When you click the link, the list expands to display the subtasks.
- **Asterisk (*):** This indicates that you should click that link and perform the tasks and any subtasks presented. If multiple links have an asterisk, you can perform the marked tasks in any order.
- **Check mark (✓):** This indicates that the tasks for this link and any sublink are complete. You can double click the link to edit the configuration at any time.
- **Exclamation mark (!):** This indicates a potential validation error.

Carry out the following to set up a change data capture:

- [Create a CDC Project](#)
- [Set up the CDC Server](#)
- [Set up the Staging Area Server](#)

2.4.3.1 Create a CDC Project

Do the following to create a CDC Project

1. From the **Start** menu, select, **Programs, Oracle**, and then select **Studio**.
2. Open the CDC Solution perspective, click the **Perspective** button on the perspective toolbar and select **CDC Solution** from the list.

The CDC Solution perspective opens with the Getting Started guide in the left pane of the workbench.

3. Click **Create new project**.

The Create new project screen opens.

4. In the **Project name** field, enter a name for your project.

The types of projects available are listed in the left pane.

5. Select **Change Data Capture**.

From the right pane, select VSAM-CICS or VSAM-BATCH.

Figure 2–20 Create New Project

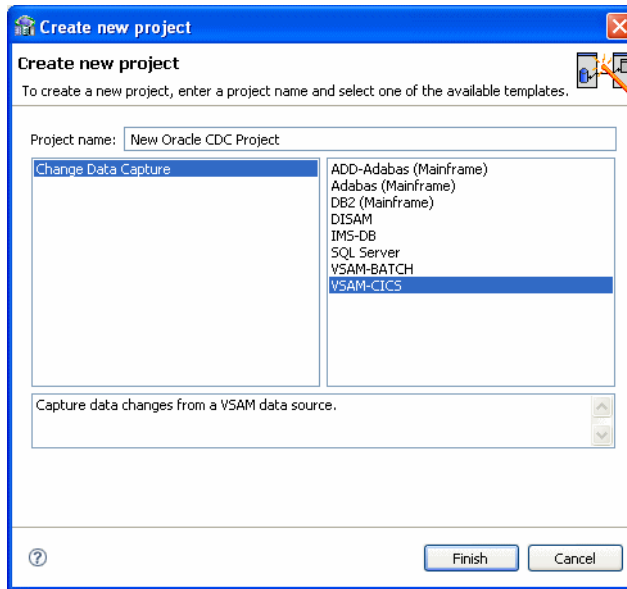

6. Click **Finish**. The Project Overview guide is displayed in the left pane.
7. Click **Design**. The Design wizard opens. Use this wizard to enter the basic settings for your project.

Note: The wizard screens are divided into sections. Some sections provide information only and other sections let you to enter information about the project. If you do not see any information or fields for entering information, click the triangle next to the section name to expand the section.

Figure 2–21 Design Wizard (Design Options)

8. In the **Client Type** you can select **Oracle SOA/ODI** only. The **Use staging area** is selected and cannot be changed, you must use a staging area with the OracleAS CDC Adapter for VSAM.
9. Click **Next**.

The Design Wizard's second screen is displayed. In this step you configure the computers used in your solution. Enter the following information:

- **Server Machine Details:** Information about the computer where Oracle Connect is installed. The selection here is always **Server Machine** and **Mainframe**.
- **Staging Area Details:** Information about the computer platform where the staging area is located.

For the server computer **Name**, select one of the following:

- **CDC Stream Service:** Select this if the Staging Area is on a staging area computer. This is the default selection.
- **Server Machine:** Select this if the staging area is on the same machine where Oracle Connect is installed.
- **Client Machine:** Select this if the Staging area is on the local computer.

In the **Platform** list, select the operating system for the staging area. This can be Windows, Linux or UNIX. The available options are:

- **Microsoft Windows**
- **HP-UX**
- **IBM AIX**
- **Sun Solaris**

- Linux (Red Hat)
- Suse (Linux)

Figure 2–22 Design Wizard (Configure Solution Machines)

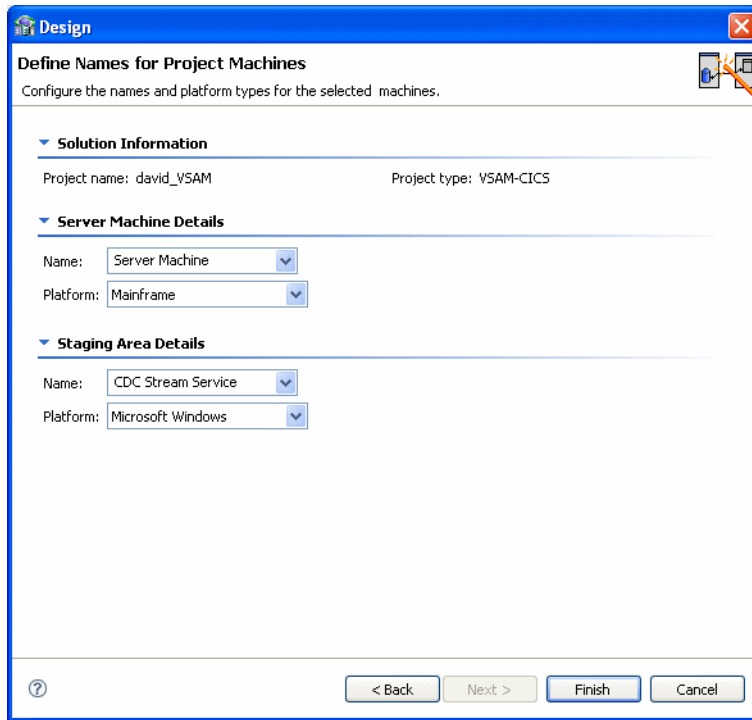

10. Click **Finish**. The wizard closes.

2.4.3.2 Set up the CDC Server

Click **Implement** in the **Getting Started** guide to open the Implementation guide.

In the Implementation guide, do the following to set up the CDC server:

- [Set up the Machine](#)
- [Configure the VSAM Data Source](#)
- [Copy the Metadata](#)
- [Set up the CDC Service](#)

Set up the Machine

You do the following to define the IP Address/host name and Port for the CDC server machine.

1. Click **Machine**.

The machine definition screen is displayed:

Figure 2–23 Machine Definition

2. In the **IP address/host name** field, do *one* of the following:
 - Enter the server computer’s numeric IP address.
 - Click the **Browse** button and select the host computer from the ones presented, then click **Finish**.

Figure 2–24 Select Machine

Note: The machine you enter must be compatible with the platform designated in the [Design Wizard \(Configure Solution Machines\)](#) screen.

3. Enter the port number.
The default port number is **2551**.
4. To connect with user authentication, enter a user name and password, with confirmation, in the Authentication Information area.

5. Select the **Connect via NAT with a fixed IP address** check box if you are using Network Access Translation and want to always use a fixed IP address for this machine.
6. Click **OK**.

Continue setting up the CDC Server on the z/OS computer.

Configure the VSAM Data Source

In this step, configure the VSAM data source that is part of the VSAM CICS CDC solution. Carry out the following procedure to configure the data source.

1. In the CDC Solution perspective, click **Implement**.
2. In the Server Configuration section, click **Data Source**. The Data Source Configuration window is displayed.
3. Define the parameters for your data source in the Data Source Configuration window.

If you are using a VSAM CICS data source define the following parameters:

- **CICS Application ID:** Enter the VTAM ID of the CICS target system (mandatory).
- **Transaction ID** Enter the EXCI or other CICS transaction that activates DFHMIRS CICS program.
- **VTAM NetName** Enter the VTAM network name of the specific connection being used by EXCI (and MRO) to relay the program call to the CICS target system (mandatory).
- **Program Name:** Enter the UPDTRNS program (supplied with the OracleAS CDC Adapter for VSAM under CICS).
- **Trace Queue** Enter the name of queue for output which is defined under CICS when tracing the output of the UPDTRNS program. When not defined, the default CICS queue is used.

If you are using a VSAM Batch data source define the following parameters:

- **Data HLQ:** The high-level qualifier where the data files are located.
- **Disk volume Name:** The high-level qualifier (volume) where the data resides.

The values specified are used in the Data File field in the Oracle Studio Design perspective, Metadata tab. For tables created using the `CREATE TABLE` statement, the values specified are used to create the data files. If values are not specified, then data files are written to the DEF high-level qualifier under the high-level qualifier where Oracle Connect is installed.

When SMS is used to manage the volumes, leave this value empty and set the `newFileSMSStorageClass` and `newFileSMSDataClass` properties as described in [VSAM Properties](#).

4. Click **Finish**.

Continue setting up the CDC Server on the z/OS computer.

Copy the Metadata

In this step, copy the metadata that you imported when [Importing Metadata for the VSAM Data Source](#). Do the following to copy the metadata.

1. Click **Metadata**.

The Create metadata definitions view is displayed.

Note: The Select Metadata Source link has an asterisk (*) next to it to indicate that you must carry out this operation first.

2. Click the **Select Metadata Source** link.
3. Select **Copy from existing metadata**.
4. Click **Finish**. The screen closes.
5. Click **Copy from existing metadata source**.

The Copy Existing Metadata Source screen is displayed showing your local computer and with metadata compatible with the data source selected.

Figure 2–25 Copy Existing Metadata Source

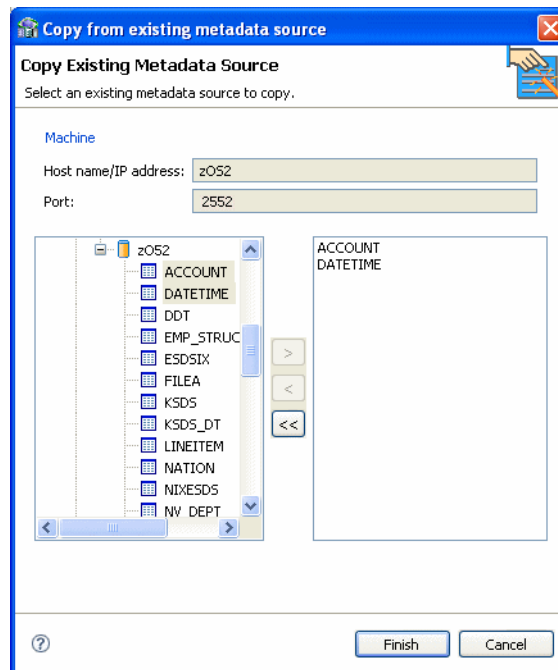

6. From the sources in the left pane, expand the list until you see the tables from the data source you configured when [Importing Metadata for the VSAM Data Source](#).
7. Using the arrow buttons, select the required tables and move them into the right pane.
8. Once you have selected all the desired tables, click **Finish**.
9. Click **Customize Metadata**.

The customize metadata screen is displayed.

Note: If you do not want to make any customizations to the metadata, click **Finish** to close this screen. A check mark (✓) appears next to **Customize Metadata** indicating that this step is complete.

Continue with another step in the design wizard.

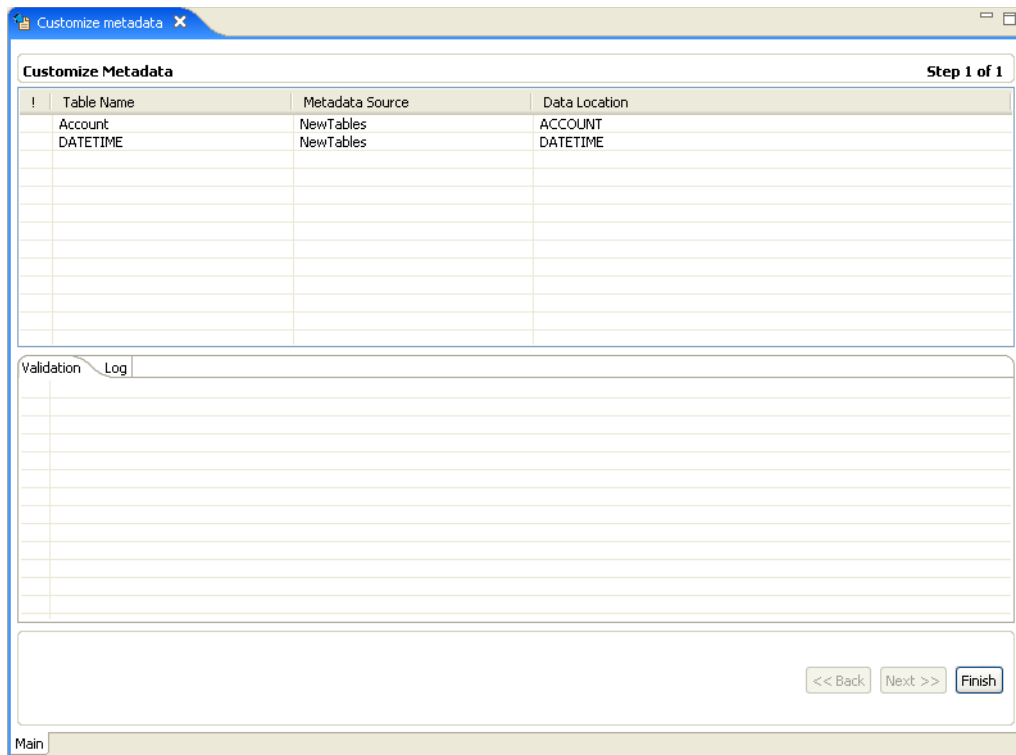
Figure 2–26 Customize Metadata

10. To change a table name, right-click in the any field under **Customize Metadata**, and select **Add**.

11. Enter the table name in the field presented, and click **OK**.

Note: You may have validation errors in the tables created, which you can correct by the end of the procedure.

12. To make changes to any field in a table, right-click the table created and select **Fields Manipulation**.

The Field Manipulation screen is displayed.

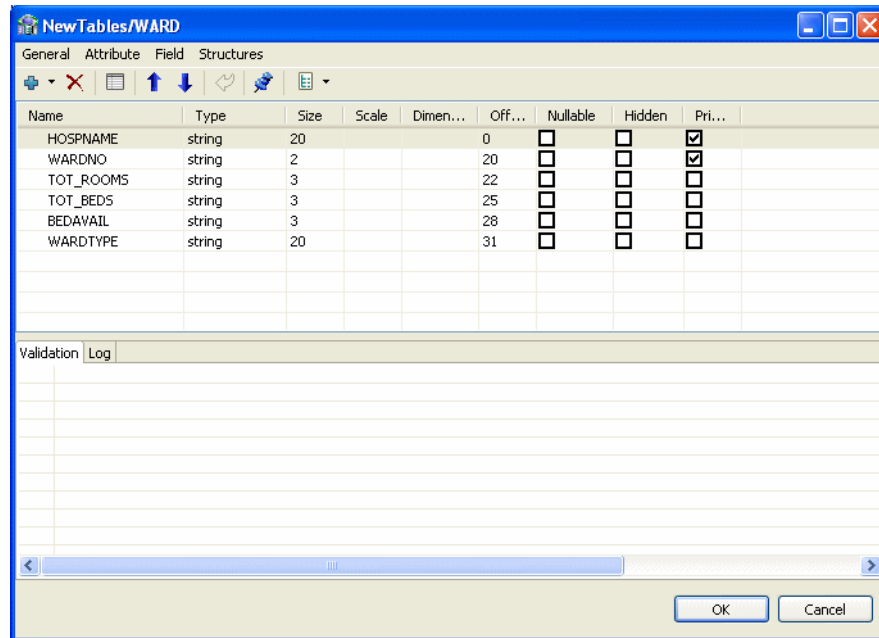
Figure 2–27 Field Manipulation

13. Right-click in the upper pane and select **Field | Add | Field**.
14. Enter the name of the field in the screen provided, and click **OK**.
15. Default values are entered for the table. To manipulate table information or the fields in the table, right-click the table and choose the option you want. The following options are available:
 - **Add table:** Add a table.
 - **Field manipulation:** Access the field manipulation window to customize the field definitions.
 - **Rename:** Rename a table name. This option is used especially when multiple tables are generated from the COBOL with the same name.
 - **Set data location:** Set the physical location of the data file for the table.
 - **Set table attributes:** Set table attributes.
 - **XSL manipulation:** You specify an XSL transformation or JDOM document that is used to transform the table definition.

The **Validation** tab at the bottom of the window displays information about what you must do to validate the tables and fields generated from the COBOL. The **Log** tab displays a log of what has been performed (such as renaming a table or specifying a data location).

16. Correct any remaining validation errors.
17. Click **Finish** to generate the metadata.

Continue setting up the CDC Server on the z/OS computer.

Set up the CDC Service

In this step you define the starting point or event for the change capture and then indicate the name of the change logger. Do the following to set up the CDC service.

1. In the CDC Solution perspective, click **Implement**.

2. In the Server Configuration section, click **CDC Service**. The CDC Service wizard is displayed.
3. In the first screen select *one* of the following to determine the Change Capture starting point:
 - **All changes recorded to the journal**
 - **On first access to the CDC (immediately when a staging area is used, otherwise, when a client first requests changes)**
 - **Changes recorded in the journal after a specific date and time.**

When you select this option, click **Set time**, and select the time and date from the dialog box that is displayed.
4. Click **Next** to define the logger. The following is displayed.

Figure 2–28 CDC Logger Definition Window

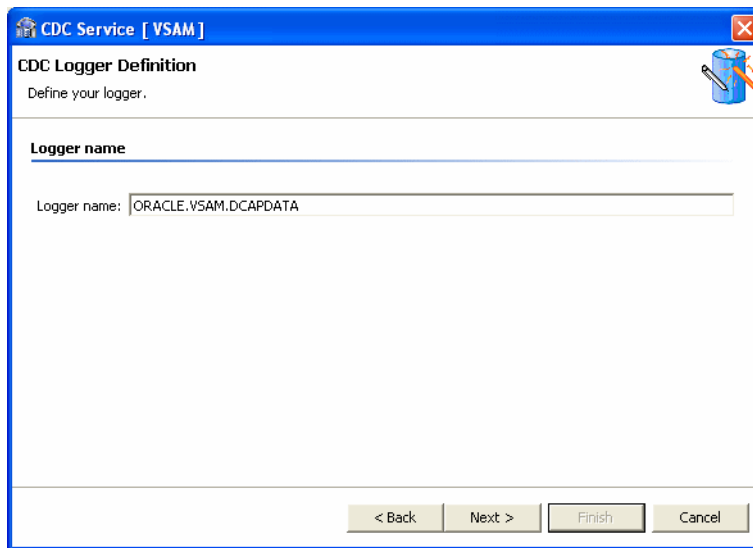

5. In the **Logger Name** field, enter the name of the MVS logstream used for the data capture.
6. Click **Next** to go to the next step where you set the CDC Service Logging. Select the log level to use from the **Logging level** list.

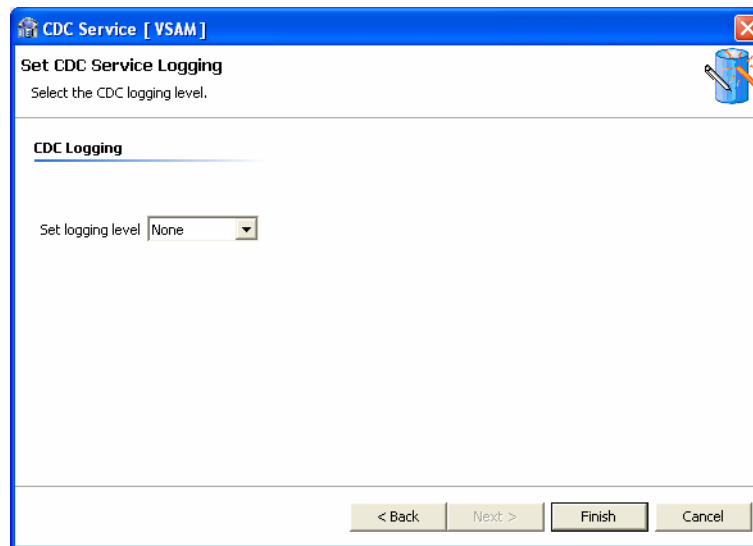
Figure 2–29 Logging Level

Select *one* of the following from the list:

- None
- API
- Debug
- Info
- Internal Calls

7. Click Finish.

Continue setting up the CDC Server on the z/OS computer.

2.4.3.3 Set up the Staging Area Server

Click **Implement** in the **Getting Started** guide to open the Implementation guide.

In the Implementation guide, do the following under the **Stream Service Configuration** section, to set up the staging area server:

- [Set Up the Staging Area Machine](#)
- [Set up the Stream Service](#)
- [Configure the Access Service Manager](#)

Set Up the Staging Area Machine

To set up the machine for the staging area, do the following.

1. Under the Stream Service Configuration section, click **Machine**.
2. Use the same configurations used to [Set up the Machine](#) for the CDC server.

Continue setting up the staging area Server.

Set up the Stream Service

In this step you set up the stream service. The Stream Service configures the following:

- Staging area

- Filtering of changed columns
- Auditing

Note: Null filtering is currently unsupported. Filtering empty values is supported. Space values are truncated and are handled as empty values.

1. Click **Stream Service**. The Stream Service wizard opens.

Figure 2–30 Staging Area

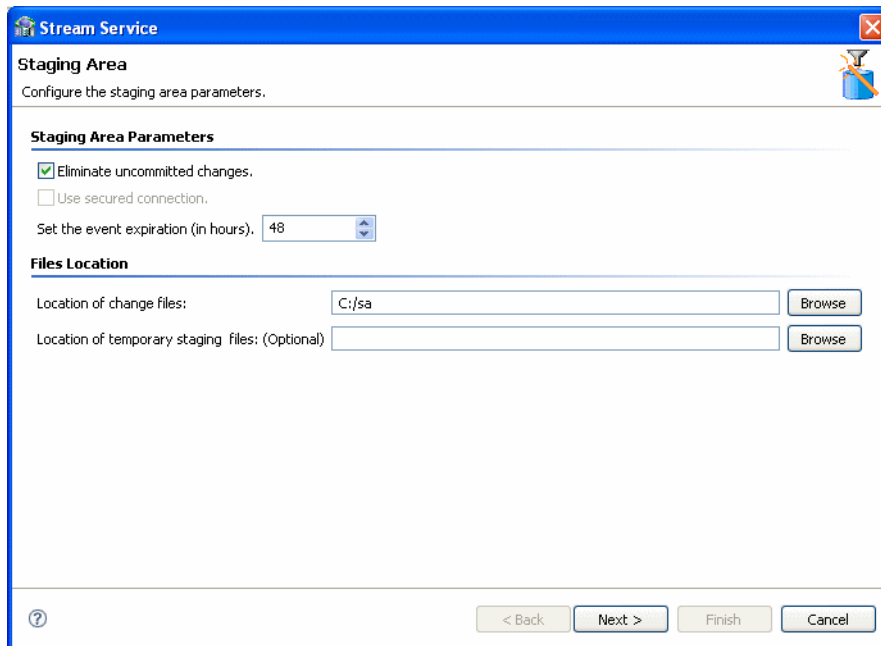

Note: This screen appears only if you selected the inclusion of a staging area in your solution.

2. You can configure the following parameters in this screen:
 - Select **Eliminate uncommitted changes** to eliminate uncommitted changes from your CDC project.
 - Select the **Use secured connection** check box to configure the staging area to have a secured connection to the server. This is available only if you logged into the server using user name and password authentication.
 - Set the event expiration time in hours.
 - Under File Locations, click the **Browse** buttons to select the location of the changed files, and temporary staging files, if necessary.
3. Click **Next** to select the tables to include in the filtering process.

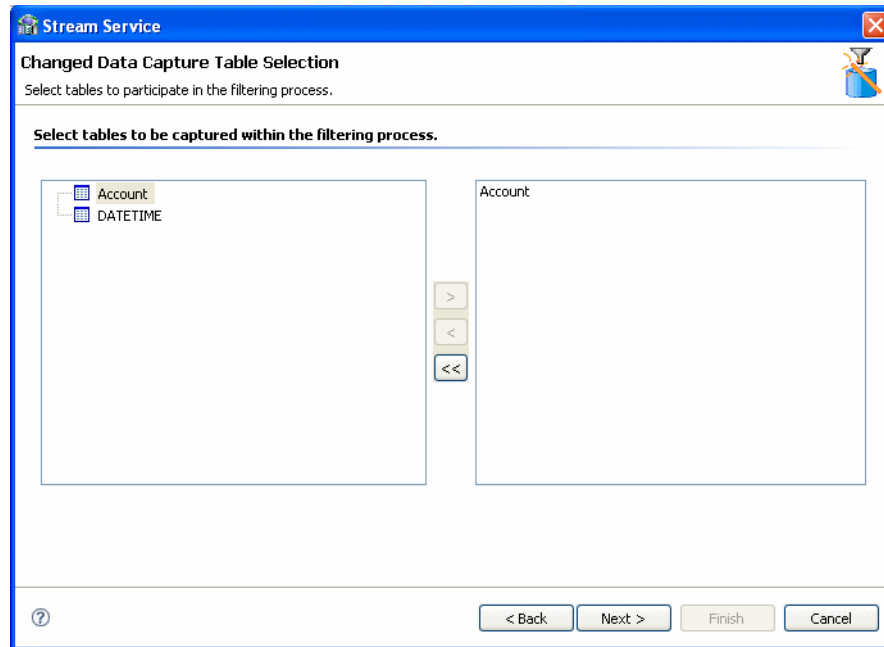
Figure 2–31 Select Tables

4. Click the required tables in the left pane and move them to the right pane using the arrow keys.

Note: You can remove the tables and add new ones to be captured after you add the tables to the right pane. For more information, see [Adding and Removing Tables](#).

5. Click **Next**. From the tables selected above, select the columns that receive changes. Select the check box next to the table to use all columns in the table.

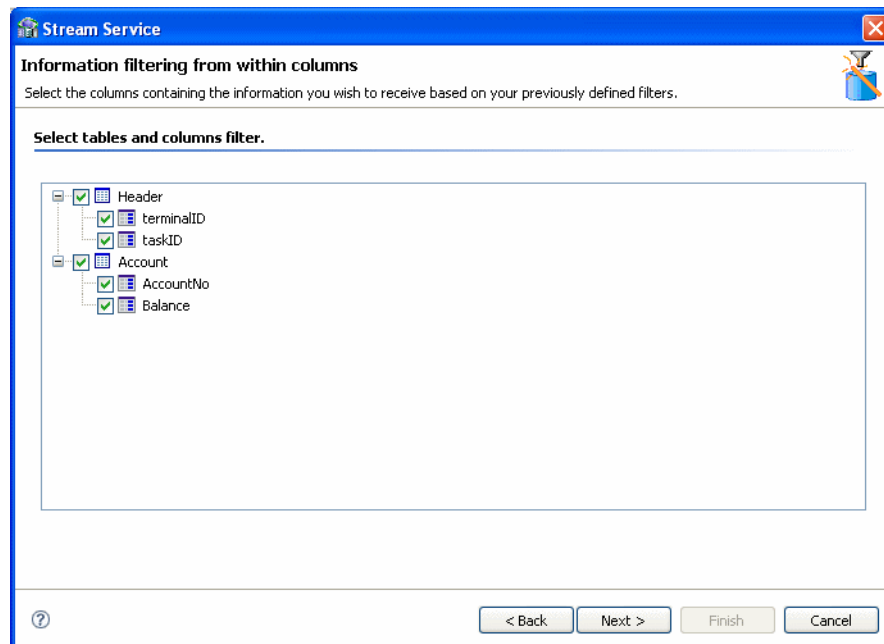
Figure 2–32 Column Selection

Note: Table headers appear grouped in a separate table at the beginning of the list. You can also request the receipt of changes in the headers' columns.

Any data changes in the columns selected are recorded.

- Click **Next**. The Filter selection screen is displayed. the types of changes you want to receive in the tables and which columns to display.

Figure 2–33 Filter Selection

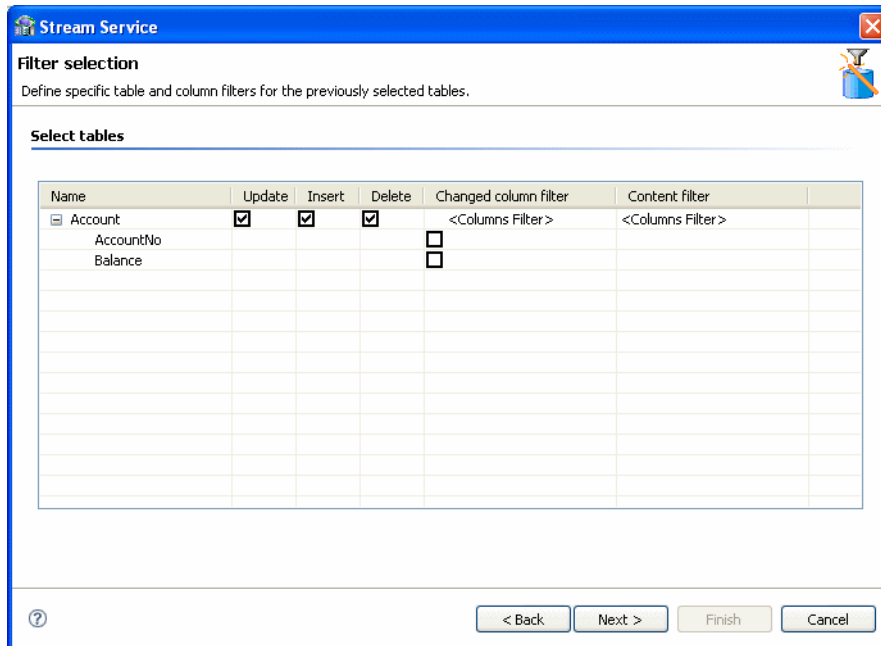

- You can do the following in this screen:

Select the actions from which you want to receive change information:

- Update
- Insert
- Delete

Note: These items are all selected by default.

- Under the Changed Columns Filter column, select the columns for which you want to receive notification of changes.

Notes:

- If you do not select a column, you receive notification of *all* changes.
- If you select only one column, you receive change information only if the field selected undergoes a change.
- If you select multiple columns, but not all, you receive change information only if any or all of the selected fields undergo a change.

8. In the **Content Filter** column of the Filter screen, double-click a table column and then click the **Browse** button to filter content from the selected column.

The Content Filter screen is displayed.

Figure 2–34 Content Filter

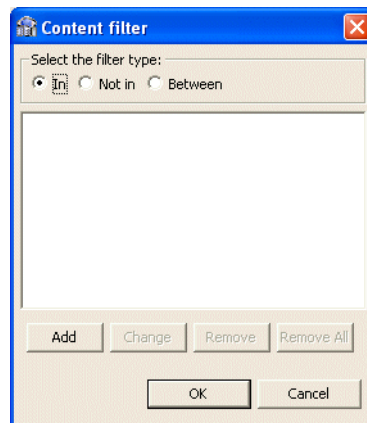

9. Select a filter type:
 - Select **In** for events to be returned where the relevant column value equals the values you specify (if a column is NULL, it is not captured).
 - Select **Not In** for events to be returned where the column value is *not* in the values you specify (if the column is NULL, it is captured).
 - Select **Between** for when the column value is between the two values you specify (if a column is NULL, it is not captured).
10. Click **Add** in the lower-left corner of the **Content Filter** screen.

Note: If you select multiple conditions, you receive the change information if one of the conditions is true.

11. Depending on your selection, do *one* of the following:
 - If you selected **In/Not In**, continue with step 12.
 - If you selected **Between**, continue with step 14.
12. Click **Add** in the Add items to the list screen. Enter a value for events to be returned where the column value appears (or does not appear) in that value. To

filter empty values (") for the **Not In** filter type, leave this field blank in the dialog box that is displayed.

Figure 2–35 Add Items (In or Not In)

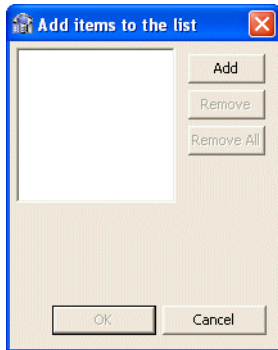

13. Repeat steps 12 as many times as necessary, and then proceed to step 16.

14. Click **Add** in the Add items to list screen.

The Add between values screen is displayed.

Figure 2–36 Add Items (Between)

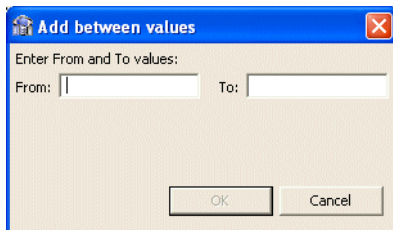

15. Enter values for events to be returned where the column value is between the two values you specify.

16. In the content filter screen, click **Next**.

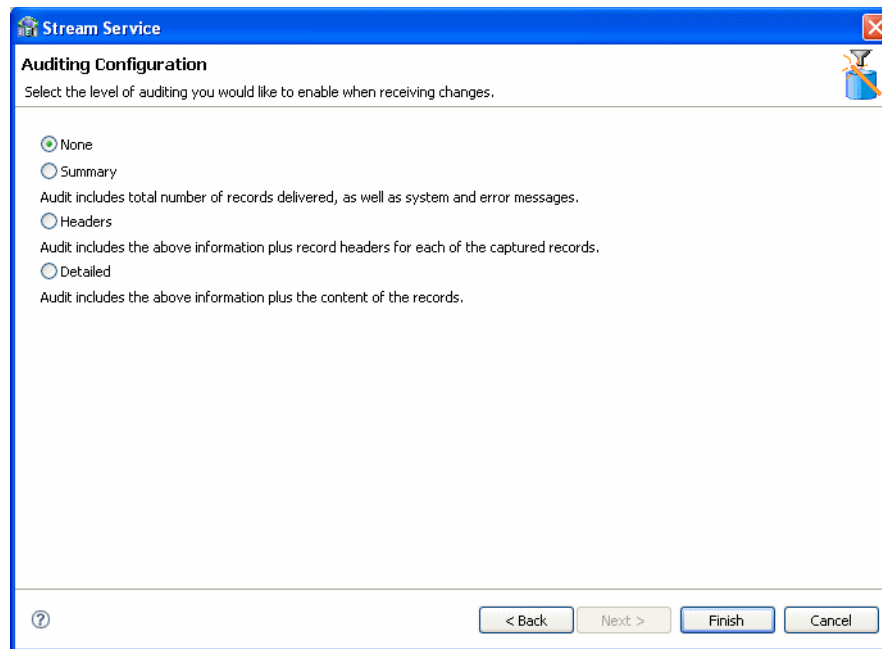
Figure 2–37 Auditing Configuration

17. Select the required auditing level when receiving changes. Your options are:

- **None:** For no changes.
- **Summary:** For an audit that includes the total number of records delivered, system messages, and error messages.
- **Headers:** For an audit that includes the total number of records delivered, system and error messages, and the record headers for each captured record.
- **Detailed:** For an audit that includes the total number of records delivered, system and error messages, the record headers for each captured record, and the content of the records.

18. Click **Finish**.

Continue setting up the staging area Server.

Configure the Access Service Manager

In this step you set up a daemon workspace for the CDC adapter. Do the following to configure the access service manager.

1. Click **Access Service Manager**.

The Setup Workspace wizard opens.

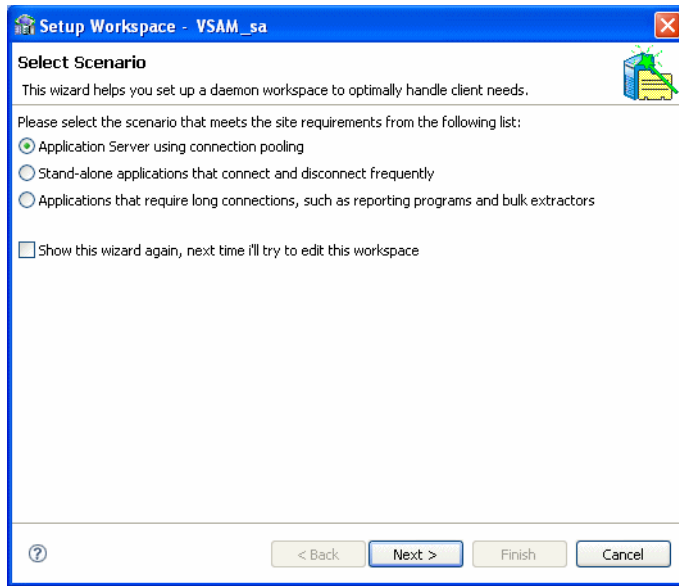
Figure 2–38 Select Scenario

2. Select the scenario that best meets your site requirements:
 - **Application Server using connection pooling**
 - **Stand-alone applications that connect and disconnect frequently**
 - **Applications that require long connections, such as reporting programs and bulk extractors**
3. Click Next.

The Application Server with connection pooling scenario screen is used to create a workspace server pool. The parameters available depend on the selection you made in the first screen. The following are the available parameters:

- If you selected **Application Server using connection pooling**:
 - **What is the average number of expected concurrent connections?** Enter the number of expected connections, which cannot be greater than the number of actual available connections.
 - **What is the maximum number of connections you want to open?** Enter the number of connections you want opened.
- If you selected **Stand-alone applications that connect and disconnect frequently**, in addition to the choices listed in the item above, you can also set the following:
 - **What is the minimum number of server instances you want available at any time?** Enter the number of instances, which cannot be greater than the number of actual available instances.
 - **What is the maximum number of server instances you want available at any time?** Enter the number of instances you want to be available.
- If you selected **Stand-alone applications that connect and disconnect frequently**:
 - **How many connections do you want to run concurrently?** Enter the number of concurrent connections to run.

4. Click **Next**. In the next screen you set time out parameters. These parameters should be changed if the system is slow or overloaded. The parameters are:
 - **How long do you want to wait for a new connection to be established?** Enter the amount of time you want to wait for a new connection to be established (in seconds).
 - **How long do you want to wait for a response that is usually quick?** Change this parameter if you have a fast connection. Enter the amount of time to wait for a response (in seconds).
5. Click **Next**. In the next screen you set security parameters. You should consult with the site security manager before changing these parameters.

Edit the following parameters in this screen:

- Enter the operating system account (user name) used to start server instances.
- Select **Allow anonymous users to connect via this workspace**, to allow this option.
- Enter the permissions for the workspace. You can allow **All users** to access the workspace, or select **Selected users only** to allow only the users/groups to have exclusive access.
- Select **Do you want to access server instances via specific ports**, to allow this option. If this option is cleared, the defaults are used.

If you select this option, indicate the **From port** and **To port** and ensure that you reserve these ports in the TCP/IP system settings.

Figure 2–39 Site Security

6. Click **Next**.
The summary screen opens.

Figure 2–40 Workspace Setup Summary

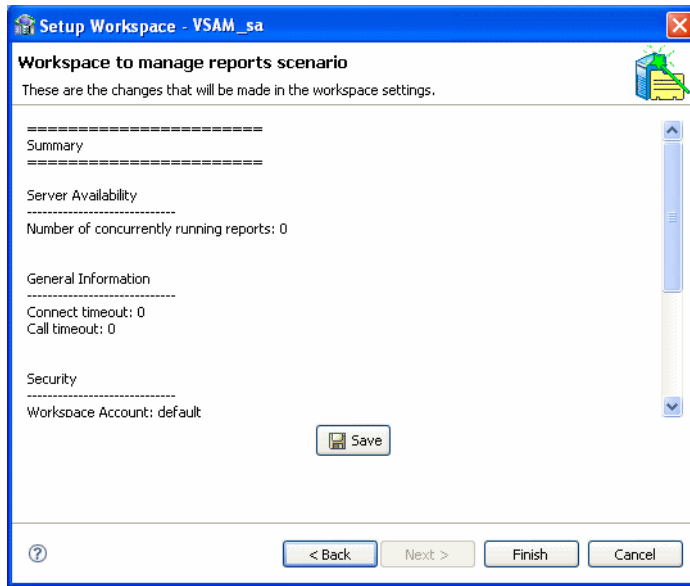

7. Click **Save** and then click **Finish**.

When you complete all the Implementation operations, a check mark (✓) is displayed next to every link. Click **Done** to return so you can begin [Deploying a Change Data Capture](#).

Continue setting up the staging area Server.

2.4.4 Deploying a Change Data Capture

After you complete the design and implementation guides, the following procedures are available.

- **Deployment Procedure:** This section is used to deploy the project.
- **Control:** This section is used to activate or deactivate workspaces after the project is deployed and you are ready to consume changes. In this section, you can deactivate the workspace anytime you want to suspend consumption of changes from the staging area.

Do the following to deploy the CDC solution:

1. Click **Deploy**. The Deployment Procedure and Control sections are displayed in the Deployment view.
2. Click **Deploy** in the **Deployment Procedure** section.

Oracle Studio processes the naming information. This may take a few minutes. If there are naming collisions, a message is displayed asking if you want Oracle Studio to resolve them.

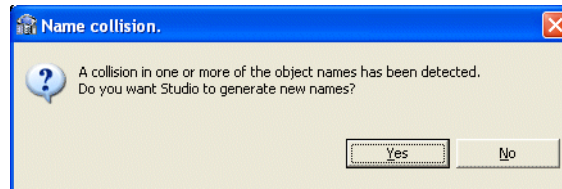
Figure 2–41 Resolve Naming Collision

3. Click **Yes** to resolve any naming collisions.
The Deployment Guide screen is displayed.

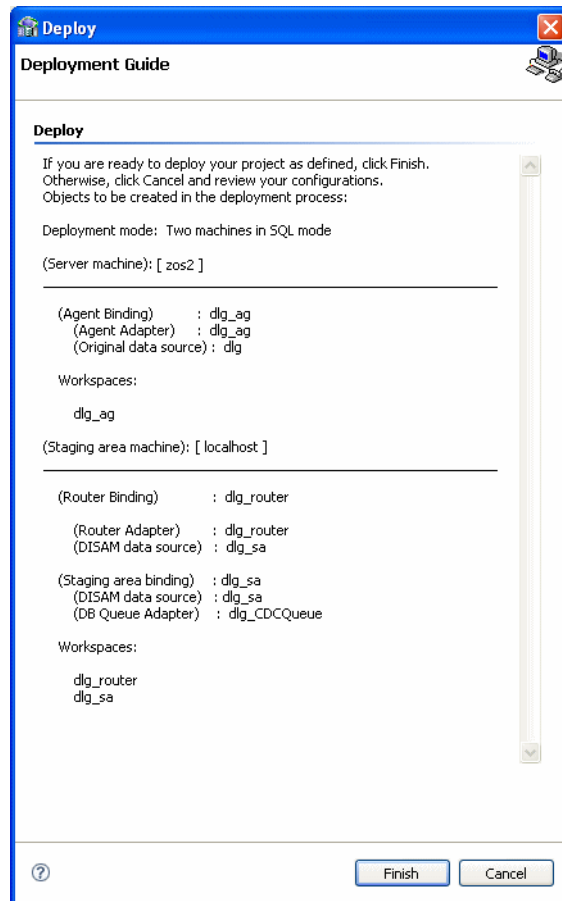
Figure 2–42 Deployment Guide

4. If you are ready to deploy, click **Finish**.
Otherwise, click **Cancel** and you can return to [Create a CDC Project](#), [Set up the CDC Server](#), or [Set up the Staging Area Server](#) to make any changes.
If this project was deployed previously, you are notified that re-deployment overrides the previous instance.

Notes:

- When you redeploy a project where the metadata is changed, the Staging Area (SA) tables should be deleted so that no incorrect information is reported.
- When you re-deploy a solution, a new binding is created for the solution. The new binding is created with the default parameters only. Any temporary features that were added are lost.

5. Where applicable, click **OK** to redeploy.

6. Click the **Deployment Summary** link.

The Deployment Summary is displayed. It includes the ODBC connection string, JDBC connection string, and specific logger scripts to enable CDC capturing.

Figure 2–43 Deployment Summary

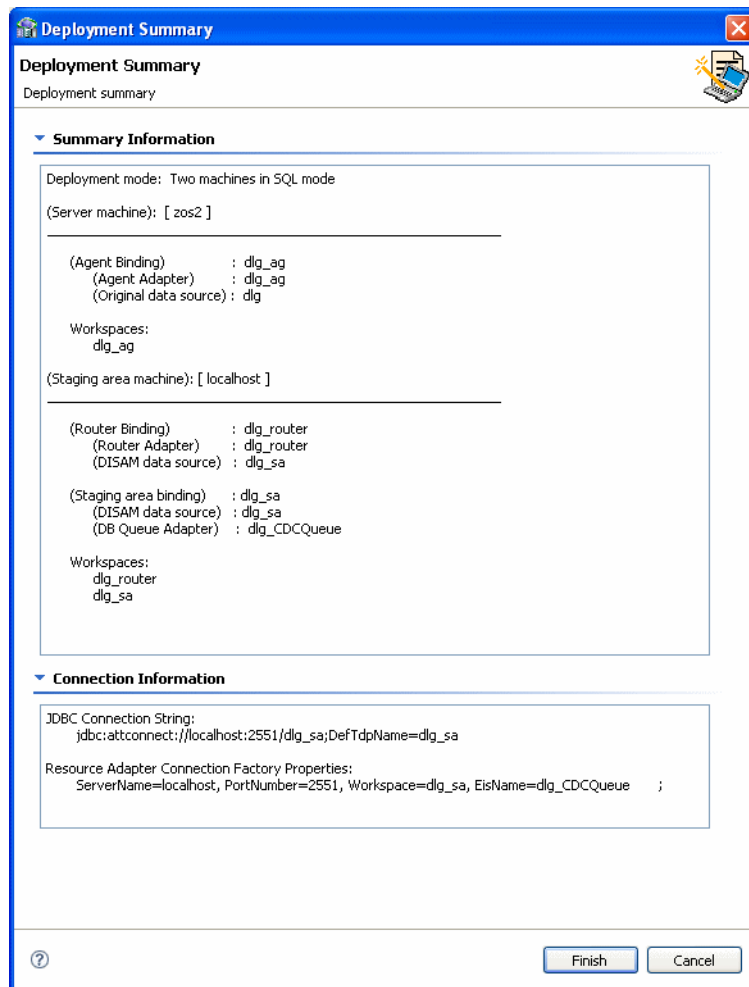

7. Cut and paste any information required from the Deployment Summary screen to your environment as necessary.

8. If there is nothing wrong with your deployment results, click **Finish**.

If you found problems, click **Cancel** and to return [Create a CDC Project](#), [Set up the CDC Server](#), or [Set up the Staging Area Server](#) to modify the solution.

Note: If you are redeploying a solution you must follow these directions to ensure that the `context` and `adapter_context` fields of the `SERVICE_CONTEXT` table must be saved. Follow these directions to save the fields:

1. In the staging area data source run: `select context, agent_context from SERVICE_CONTEXT`; and save the returned values.
 2. Delete the `SERVICE_CONTEXT` table physical files.
 3. Redeploy the solution.
 4. Activate the router to create the `SERVICE_CONTEXT` table.
 5. Disable the router.
 6. In the staging area data source run: `insert into SERVICE_CONTEXT (context, agent_context) values('XXX', 'YYY')`. This inserts the saved values to the `SERVICE_CONTEXT` table.
 7. Activate the solution.
-
-

2.4.4.1 Activating and Deactivating Solution Workspaces

In the Project guide for your OracleAS CDC Adapter solution, click **Deploy**, then do *one* of the following to activate or deactivate the workspaces for a solution

- To activate workspaces, under the Control section click the **Activate Workspaces** link.
- To deactivate workspaces, click the **Deactivate Workspaces** link.

During the activation/deactivation process, you may receive messages indicating that the daemon settings on one or more of the computers involved in your solution have changed. Click **Yes** to proceed.

WebLogic Deployment and Adapter Integration

This chapter includes the following topics:

- [Configuring the VSAM CDC Adapter In the Application Server](#)
- [Configuring the JCA Configuration Files for the OracleAS CDC Adapter for VSAM](#)

3.1 Configuring the VSAM CDC Adapter In the Application Server

You can use WebLogic application server to deploy the Oracle Connect CDC adapter. This section describes how to deploy the CDC adapter, set up the necessary connections, and build the CDC Stream Positions table.

This section includes the following topics:

- [CDC Stream Positions Table Definition](#)
- [Configuring the VSAM CDC Adapter Connection Factory](#)

3.1.1 CDC Stream Positions Table Definition

You should create one CDC Stream Position table for each CDC adapter. The CDC Stream Positions table contains one row for each CDC process (for each captured table) to control its stream position and XA transactions. The following SQL statement is used to define the table in an Oracle database:

```
create table CDC_STREAM_POSITIONS(TABLE_NAME varchar(127) not null,
STREAM_POSITION varchar(127), PREPARED_STREAM_POSITION varchar(127),
ROLLBACK_STREAM_POSITION varchar(127), NEW_STREAM_POSITION varchar(127),
XID_FORMAT int, XID_BRANCH varchar(128), XID_GLOBAL varchar(128));
create unique index CDC_STREAM_POSITIONS_INDEX on CDC_STREAM_POSITIONS
(TABLE_NAME);
```

You can use any table name, but you cannot change the column names.

The following table describes the CDC Stream Positions table columns.

Table 3–1 CDC Stream Positions Table

Column	Description
TABLE_NAME	The name of the CDC table. You should not change the data in this column.

Table 3–1 (Cont.) CDC Stream Positions Table

Column	Description
STREAM_POSITION	The last committed stream position of the CDC process for the current table. You should not change the data in this column.
PREPARED_STREAM_POSITION	The last prepared stream position of the CDC process for the current table. You should not change the data in this column.
ROLLBACK_STREAM_POSITION	In a Rollback Loop , this column contains the stream position of the event that occurred at the time of the rollback.
NEW_STREAM_POSITION	You can enter a valid stream position value in this column to manually change the current stream position. Before you update this column, deactivate the corresponding CDC process. Note: Ensure that the <code>XID_FORMAT</code> column has a null value. If the <code>XID_FORMAT</code> column is not null, do not enter a value for this column.
XID_FORMAT	The last prepared XID fields. If the <code>XID_FORMAT</code> column is null, the stream position is committed. In this case the <code>XID_BRANCH</code> and <code>XID_GLOBAL</code> columns contain the last committed XID fields.
XID_BRANCH	
XID_GLOBAL	

You should configure a WebLogic data source that provides access to the CDC Stream Position table.

3.1.2 Configuring the VSAM CDC Adapter Connection Factory

Deploy the Oracle Connect RAR into the WebLogic server.

You may create the appropriate connection factories for each CDC adapter.

This table describes the connection factory properties that are relevant for the VSAM CDC Adapter. Do not change the values of any of the other properties.

Table 3–2 Connection Properties for CDC Inbound Process

Property	Description
eisName	Required. Sets the name of the adapter to use. The adapter is defined in the Oracle Connect server using Oracle Studio.
serverName	Required. Enter the name of the server with the TCP/IP address or host name where the Oracle Connect daemon is running. For more information, see Advanced Tuning of the Daemon for details about the daemon.
workspace	Required. Specifies the name of an Oracle Connect server workspace to use. For more information, see Workspaces for details about workspaces.
portNumber	Optional. Specifies the TCP/IP port where the Oracle Connect daemon is running on the server. The default port is 2551.

Table 3–2 (Cont.) Connection Properties for CDC Inbound Process

Property	Description
userName	Optional. Specifies a user who can access the Oracle Connect server. The user is defined in the Oracle Connect daemon configuration. For more information, see daemon Security and workspace Security for details about users allowed to access an Oracle Connect server.
password	Optional. Specifies a valid password for the user.
firewallProtocol	Optional. Specifies the firewall protocol used: either <code>none</code> or <code>fixedNat</code> (the Nat protocol using a fixed address for the daemon). The default is set to <code>none</code> .
connectTimeout	Optional. Specifies the connection timeout in seconds. The default is 0, indicating that there is no connection timeout.
encryptionProtocol	Optional. Specifies the name of encryption protocol to use. The default is set to RC4. If the value of the property is not defined, the RC4 protocol is used.
encryptionKeyName	Optional. Specifies the name of the symmetric encryption key to use.
encryptionKeyValue	Optional. Specifies the value of the symmetric encryption key to use.
retryInterval	Optional. The amount of time the resource adapter waits if no events are found in the server before issuing the next request. The default value is 15 seconds.
jdbcDataSource	Required. The JNDI location of the JDBC Data Source that provides access to cdcStreamPositionsTable .
cdcStreamPositionsTable	The SQL table that is used to control the CDC inbound process. For more information, see CDC Stream Positions Table Definition for more information.

3.2 Configuring the JCA Configuration Files for the OracleAS CDC Adapter for VSAM

This section includes the following topics:

- [Creating JCA Configuration Files](#)
- [Configuring the Binding File](#)

3.2.1 Creating JCA Configuration Files

Perform the following steps to create a binding file and a WSDL file for the CDC adapter using Oracle Studio:

1. From the **Start** menu, select **Programs, Oracle**, and then select **Studio**.
2. In the Design perspective, Configuration view, expand the **Machine** folder.
3. Expand the machine with the CDC staging area.

4. Expand the **Bindings**. The binding configurations available on this computer are listed.
5. Expand the binding for the CDC staging area that you created. The name of the binding is the Project name for the CDC solution that you created in Oracle Studio with the suffix `_SA`.
6. Expand the **Adapters** folder, right-click the adapter, and select **Generate JCA Configuration Files**.
The JCA Configuration Files dialog box opens.
7. In the **Save to** field, type the path to the location where you want to save the created files, or select **Browse** to browse to a location.
8. In the **JNDI Location** change the default value for the WebLogic Connection Factory JNDI location, if necessary.
9. Click **OK** to create the files in the specified location.

The View Generated Content dialog box opens. It provides links to the binding file (*.jca) and the WSDL file that are created. If you want to view or edit the files, click the appropriate link in the dialog box.

Use these files when working with the BPEL Process Manager or Mediator.

3.2.2 Configuring the Binding File

You should not edit the WSDL file generated by Oracle Studio. You may edit the binding file to configure the `AttuCDCActivationSpec` properties. Most of these properties can also be provided using the Connection Factory. For information on how to configure the Connection Factory, see [Configuring the VSAM CDC Adapter Connection Factory](#). You may also need to configure the `retryInterval` property in the binding file.

The binding file specifies the name of the adapter's connection factory as the value of the `adapterInstanceJndi` attribute of the `<jca:address>` element in the `<service>` section. If a connection factory exists on the application server, its properties are taken. Otherwise, the properties specified by the `AttuCDCActivationSpec` are used. If a value is specified by both the connection factory and the `AttuCDCActivationSpec`, the `AttuCDCActivationSpec` property overrides the value in the connection factory. If you want to use the value specified in the connection factory, you must delete the property from the binding file.

The following is an example of a CDC binding file:

```
<?xml version="1.0" encoding="UTF-8"?>
<adapter-config adapter="Legacy Adapter" name="calc"
xmlns="http://platform.integration.oracle/blocks/adapter/fw/metadata">
  <connection-factory UIConnectionName="pcbpel" csfKey="pcbpel"
location="eis/legacy/calc"/>

  <endpoint-interaction operation="add" portType="calcPortType">
    <interaction-spec
className="com.attunity.adapter.oracle.AtтуInteractionSpec">
      <property name="FunctionName" value="add"/>

      <property name="ExecutionTimeout" value="120"/>
    </interaction-spec>
  </endpoint-interaction>
  <endpoint-interaction operation="display" portType="calcPortType">
    <interaction-spec
```

```

className="com.attunity.adapter.oracle.AtтуInteractionSpec">
    <property name="FunctionName" value="display"/>

    <property name="ExecutionTimeout" value="120"/>
</interaction-spec>
</endpoint-interaction>
<endpoint-interaction operation="div" portType="calcPortType">
    <interaction-spec
className="com.attunity.adapter.oracle.AtтуInteractionSpec">
    <property name="FunctionName" value="div"/>

    <property name="ExecutionTimeout" value="120"/>
</interaction-spec>
</endpoint-interaction>
<endpoint-interaction operation="mul" portType="calcPortType">
    <interaction-spec
className="com.attunity.adapter.oracle.AtтуInteractionSpec">
    <property name="FunctionName" value="mul"/>

    <property name="ExecutionTimeout" value="120"/>
</interaction-spec>
</endpoint-interaction>
<endpoint-interaction operation="sub" portType="calcPortType">
    <interaction-spec
className="com.attunity.adapter.oracle.AtтуInteractionSpec">
    <property name="FunctionName" value="sub"/>

    <property name="ExecutionTimeout" value="120"/>
</interaction-spec>
</endpoint-interaction>
</adapter-config>

```

You must configure the following property in the binding file.

`retryInterval`: The amount of time the resource adapter waits if no events are found in the server before issuing the next request. The default is set to 15 seconds. This is optional.

3.3 High Availability

The Oracle legacy adapters for OracleAS support High Availability using OracleAS clusters with active-active and active-passive topologies.

In an active-active topology Oracle Application Server provides an active-active redundant model for all its components with OracleAS Clusters. In an OracleAS Cluster, two or more Oracle Application Server instances are configured to serve the same application workload. These instances can reside on the same computer or on different computers. The active instances may be front-ended by an external load balancer, which can redirect requests to any of the active instances, or by some other application-level configuration, such as address lists, to distribute the requests.

In an active-passive topology Oracle Application Server supports Active-passive model using OracleAS Cold Failover Clusters. In this case two or more application server instances are configured to serve the same application workload, but only one is active at any time.

For High Availability support in CDC Adapters, all the instances must have access to the Oracle database specified by the `jdbcDatasource` parameter in the binding file.

3.4 Troubleshooting Rollback Loops

When a problem occurs in the CDC resource adapter work thread, the thread waits for a defined period (`retryInterval`) then retries the last operation. If you want to stop the adapter, you must deactivate the endpoint. The behavior of the resource adapter is different according to the type of rollback loop. In all cases, the resource adapter writes the corresponding error messages to the resource adapter log file and sends the message to the message listener `onAlert` method.

- If the connection to Oracle Connect is lost, then the resource adapter always waits for a defined period (`retryInterval`) until the connection is reestablished.
- In all other cases, the resource adapter retries the last operation immediately and if the problem returns, the resource adapter waits for ascending periods of time, beginning with the `retryInterval` and doubling the wait time for each successive attempt, but not for more than one minute.

If the OracleAS resource manager invokes a rollback before a 2PC `prepare` operation, then the CDC resource adapter take steps to perform a special operation that assists you in troubleshooting the problem. In this case, the resource adapter separately sends each event from the last event array to the BPEL endpoint, which saves the stream position of the last problematic event in the `ROLLBACK_STREAM_POSITION` column.

If you notice that a rollback loop occurs in the CDC resource adapter work thread, check the value of the `ROLLBACK_STREAM_POSITION` is not null. If the value is not null, check whether there was a data problem. You can select the problematic event from the staging area, using the current stream position value. In this way you can analyze the data to determine what the problem is. In addition, you can skip the problematic event. In this case you stop the endpoint and update the `NEW_STREAM_POSITION` column with the value of the `ROLLBACK_STREAM_POSITION`.

Configuring a VSAM CDC Adapter

This chapter provides an example for creating an OracleAS adapter for VSAM. To work with an OracleAS adapter for VSAM, you must also configure either a BPEL process or a Mediator process. For information on using BPEL or Mediator, see [Creating the Project in JDeveloper Examples](#).

4.1 Creating Outbound Interactions with the OracleAS Adapter for VSAM

To work with the OracleAS Adapter for VSAM and create outbound interactions you must create an VSAM data source, import the metadata from VSAM, create a database adapter, then create interactions that are used to access the data.

4.1.1 Requirements

The following is required to perform the tasks described in this chapter:

- Computer with Windows operating system
- Mainframe computer with z/OS operating system
- Oracle Connect v 11.1.1.2 installed on the Mainframe computer
- Oracle Studio v 11.1.1.2 installed on the Windows computer.

4.2 Adding the VSAM Hospital Data Source

To create an VSAM data source you must do the following:

- [Set up Machine Access to Oracle Connect](#)
- [Add an VSAM Data Source](#)
- [Import the Metadata](#)
- [Setting up a Change Data Capture](#)

4.2.1 Prepare the System

Ensure that the Hospital database is available under VSAM on the Mainframe computer.

4.2.2 Set up Machine Access to Oracle Connect

You begin by configuring access to the Mainframe computer with your VSAM data. You configure this access with Oracle Connect. Open Oracle connect and follow the

directions [Setting Up the IBM z/OS Platform in Oracle Studio](#). Enter the following information in the Add machine dialog box:

- **Host name/IP address:** Enter the name or IP address for the Mainframe computer with the Hospital database. This should be installed in the same directory as Oracle Connect.
- **Port:** Enter the port number where the daemon is running. The default port is 2551.
- **Display name:** You do not need to enter any information in this field (By default, the display name is the host name and the port number).
- **User name:** If the computer you are accessing needs an administrator password. If so enter the name of the computer's administrator.
- **Password:** If necessary, enter the computer administrator's password.
- **Connect via NAT with fixed IP address:** Select this if the machine uses the NAT (Network Address Translation) firewall protocol, with a fixed configuration, mapping each external IP to one internal IP, regardless of the port specified.

Figure 4–1 shows the Add Machine dialog box with the correct information:

Figure 4–1 Add Machine Dialog Box

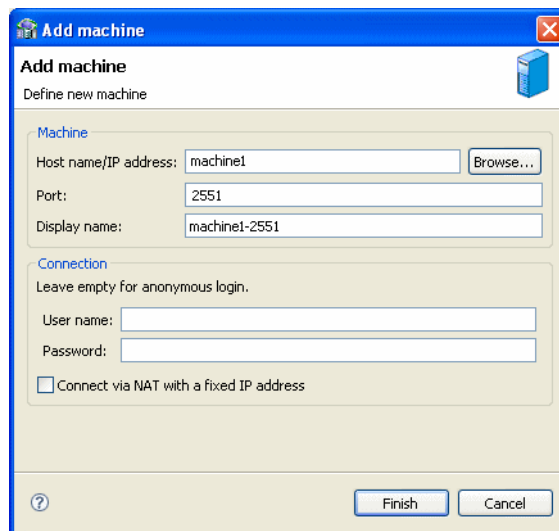

4.2.3 Add an VSAM Data Source

After you add the computer configuration to Oracle Studio, you can add your VSAM data source to the Configuration view. To add an VSAM data source, do the following:

1. Expand the computer you just added and then expand the **NAV** binding.
2. Right-click the **Data sources** folder and then select **New data source**.
3. In the New data source dialog box, type **Hospital** in the **Name** field.
4. In the **Type** field, select **VSAM (CICS)** and then click **Finish**. You do not need to add any additional connection information.

For detailed information on adding the VSAM data source, see [Configure the VSAM Data Source](#).

Figure 4–2 shows the Add data source dialog box with the correct information:

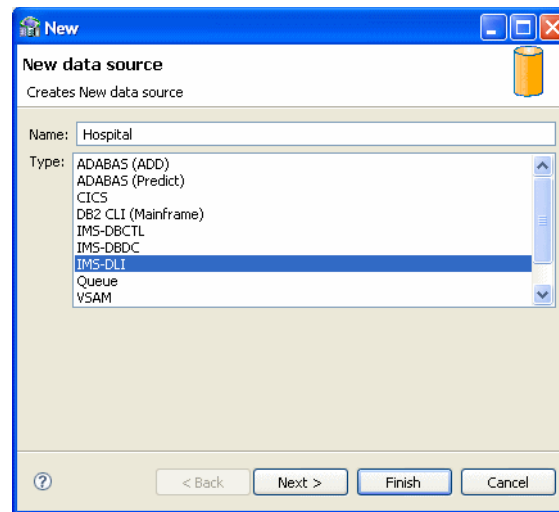
Figure 4–2 Add Data Source Dialog Box

4.2.4 Import the Metadata

You now import the metadata from the VSAM data into the data source. For information on how to import data, see [Importing Metadata for the VSAM Data Source](#).

In this example you should import the metadata for the Hospital database. This database is supplied as an example with Oracle Connect and should be installed when you install Oracle Connect on your Mainframe computer.

You need the following information for the metadata import:

- In the **Get Input Files** step, add the `hospital.cob` file.
- In the **Apply Filters** step, just click **Next**.
- In the **Select Tables** step, select DOCTOR and PATIENT.
- In the **Import Manipulation** step, click **Next**.
- In the **Assigning File Names** step, click **Next**.
- In the **Metadata Model Selection** step, select Default value for all tables, then click **Next**.
- In the **Import Metadata** step, select **Yes** and then click **Finish**.

4.3 Create a Change Data Capture

You now create the change data capture for the tables you imported. When you are finished you can create WSDL and binding (jca) files. See [Create the JCA Configuration Files](#) for more information.

These files contain the information needed to create the BPEL and Mediator projects in JDeveloper. For more information on using JDeveloper for the BPEL Process Manger and Mediator, see [Creating the Project in JDeveloper Examples](#).

Before you begin to set up your change data capture make sure that the VSAM database is set up to handle a change data capture. For information on how this is done, see [Managing the CICS User Journal \(VSAM CICS Only\)](#).

The following sections describe how to create a change data capture in Oracle Studio.

- [Setting up a Change Data Capture](#)
- [Deploy the Solution](#)

4.3.1 Setting up a Change Data Capture

The following procedure describes how to set up your change data capture for this sample. For detailed information on setting up a change data capture for VSAM, see [Setting up a Change Data Capture in Oracle Studio](#).

1. Open the Solution perspective in Oracle Studio.
2. In the left pane, click **Create new project**.
3. Enter the following:
 - Project name: Hospital
 - Type: **VSAM (CICS)**

Figure 4–3 shows the correct data in the Create new project screen.

Figure 4–3 Create New Project

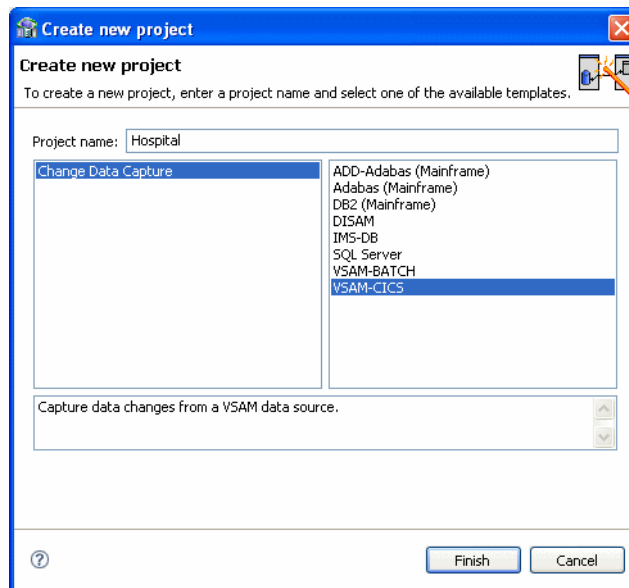

4. Click **Design** and then click **Next** and **Finish** to use the default values in the screens. If you want to set up your staging area on a UNIX computer, then you must change that setting in the second screen. For more information, see [Create a CDC Project](#).
5. Click **Implement** to go to the Implementation guide.
6. For **Server Configuration**, enter the following information:
 - **Machine:** Enter the information for the z/OS computer with Oracle Connect installed.
 - **Metadata:** Enter the following:
 - **Select metadata source:** Select **Copy from existing metadata**.

- **Copy from existing metadata source:** Find and expand the Hospital data source you created, and then select all of the available columns, and move them to the right side of the Copy Existing Metadata Source screen.
- **Customize Metadata:** Just click **Next** in all of the screens to use the default values.

For more information, see [Set up the CDC Service](#).

7. For **Stream Service Configuration**, enter the following information:
 - **Machine:** Enter the information for the computer you are using as your staging area. This must be a Windows or UNIX machine.
 - **Stream Service:** Enter the following:
 - In the Staging Area screen, enter a location for the change files on the computer you specified and the Staging Area computer.
 - In the Changed Data Capture Table Selection, select all of the tables.
 - In the remaining screens, click **Next** to use the default values.
 - **Access Service Manager:** Click **Next** in all of the screens to use the default values.

For more information, see [Set up the Staging Area Server](#).

You must now [Deploy the Solution](#).

4.3.2 Deploy the Solution

To deploy the solution, click **Activate Workspaces**. Click **OK** in any screen that opens. If you get a message about a naming collision, you must resolve this first.

For information on deploying a change data capture, see [Deploying a Change Data Capture](#).

4.4 Create the JCA Configuration Files

You must create both a WSDL and JCA file to set up your connection with JDeveloper. You create the files using Oracle Studio before setting up the BPEL process or Mediator connections.

For information on how to create JCA configuration files, see [Creating JCA Configuration Files](#). To create the files for the `Hospital_CDCQueue` adapter, do the following:

1. From the Configuration pane in Oracle Studio, expand the binding for the CDC staging area that you created. The name of the binding is the Project name for the CDC solution that you created in Oracle Studio with the suffix `_SA`.
2. Right-click the `Hospital_CDCQueue` adapter and select **Generate JCA Configuration Files**.
3. Save the files to a place you can find when you create the BPEL process or Mediator connection.

Creating the Project in JDeveloper Examples

This chapter contains the following topics:

- [Getting Started](#)
- [Deploy a BPEL Inbound Process](#)
- [Mediator Inbound Process](#)

5.1 Getting Started

This topic describes the components necessary to work with the samples and how to prepare your system. This section has the following topics:

- [Prerequisites](#)
- [Beginning Tasks](#)

5.1.1 Prerequisites

The following are installation and configuration requirements for using the examples.

- Personal computer running Microsoft Windows XP, Windows Vista, Windows Server 2003, or Windows Server 2008 with one GB of RAM.
- The CDC adapter that you are using must be deployed to the Oracle Application Server.
- OracleAS CDC Adapter must be configured for inbound processing. See [Configuring the JCA Configuration Files for the OracleAS CDC Adapter for VSAM](#).
- Oracle JDeveloper must be installed.
- CDC adapter must be deployed.
- Oracle Studio with the necessary machines loaded. See [Securing Access to Oracle Connect](#).

This chapter provides examples of the configuration steps that are used when using BPEL and Mediator to work with the Oracle CDC adapters. You should be familiar with the following before working with these examples:

- How to create J2CA connections. See [Configuring the JCA Configuration Files for the OracleAS CDC Adapter for VSAM](#) for more information.

- How to configure the OracleAS CDC Adapter for VSAM using Oracle Studio. See [Setting up a Change Data Capture in Oracle Studio](#) for more information.

Integration between the OracleAS CDC Adapters for VSAM and BPEL has the following processes:

- **Design Time:** The OracleAS CDC Adapter for VSAM is configured with Oracle Studio as described in [Setting up a Change Data Capture in Oracle Studio](#).
- **Run time:** After you deploy the BPEL process with JDeveloper, you can test your configurations. See [Run-time Configuration](#).

5.1.2 Beginning Tasks

Before you design the inbound process, you must perform the following:

- Perform the tasks in [Configuring a VSAM CDC Adapter](#) to create the CDC Solution and the adapters necessary to create the JCA configuration files.
- Configure the connection for the J2CA CDC resource adapter. You do this by creating a connection factory.

For more information, see [Securing Access to Oracle Connect](#).

- Create the WSDL and binding files for the interaction. You do this in Oracle Studio before you begin to build your endpoint in JDeveloper. Oracle Studio creates the WSDL and binding (jca) files automatically, based on the interaction you create. See [Creating JCA Configuration Files](#) for information on creating these files.

5.2 Deploy a BPEL Inbound Process

This section describes how to create a BPEL inbound process that connects to a VSAM CDC adapter. For information on how to configure a VSAM CDC adapter for inbound, see [Configuring a VSAM CDC Adapter](#).

To configure a process with the BPEL process manager, you use JDeveloper. This section describes how to create a BPEL inbound process for VSAM adapters using JDeveloper. There are two configuration types necessary to perform this inbound sample.

- [Design-Time Configuration](#)
- [Run-time Configuration](#)

Before you design the inbound process, make sure to integrate and connect your OracleAS CDC adapter for VSAM with the BPEL process manager. See [Configuring the VSAM CDC Adapter In the Application Server](#) for more information.

You must also make sure to enter the value for the `JdbcDataSource` in the `jca` file. [shows where you add this value to the jca file.](#)

Figure 5-1 JdbcDataSource Value

```

<property name="TableName" value="HOSPITAL"/>
<property name="JdbcDataSource" value="oracdc"/>
<property name="CdcStreamPositionsTable" value=""/>

```

5.2.1 Design-Time Configuration

This section describes the design-time steps necessary to deploy a BPEL inbound process:

- [Create a BPEL Inbound Process](#)
- [Use a Third-Party Adapter for the Inbound Process](#)
- [Design the BPEL Inbound Process](#)
- [Deploy the Project](#)

5.2.1.1 Create a BPEL Inbound Process

Perform the following to create a BPEL project for inbound.

1. In JDeveloper, create a new SOA project
2. Right-click the SOA project and select **New**. The New Gallery is displayed as shown in [Figure 5-2](#).

Figure 5-2 New Gallery

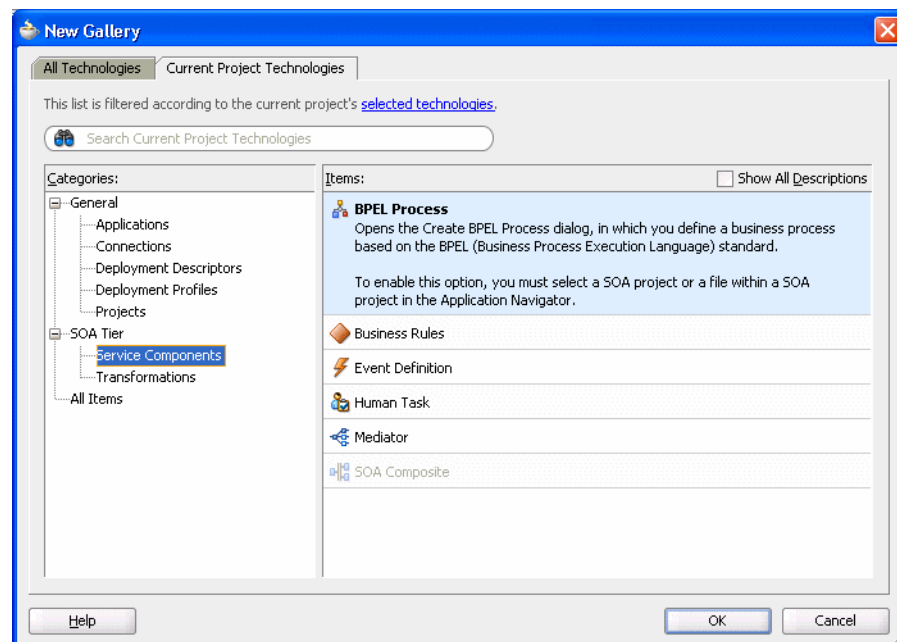

3. In the **Categories** list, expand **SOA Tier** and select **Service Components**.

4. From the **Items** list, select **BPEL Process** then click **OK**. The Create BPEL Process screen is displayed as shown in [Figure 5-3](#).

Figure 5-3 BPEL Process

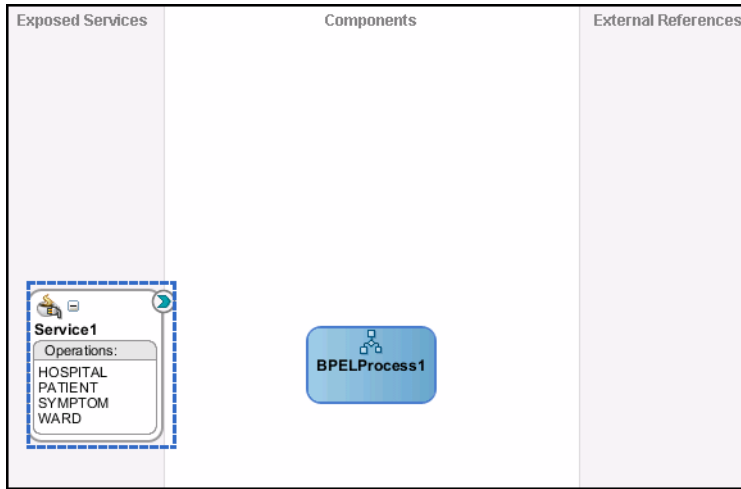

5. Enter the following in the BPEL Process screen:
 - Enter a name for the BPEL process, for example **BPELInbound1**.
 - From the Template list, select **Define Service Later**.
6. Click **OK**. The BPEL process is displayed in the visual editor.

Continue with [Use a Third-Party Adapter for the Inbound Process](#).

5.2.1.2 Use a Third-Party Adapter for the Inbound Process

You use a third-party adapter as a partner link to create the inbound process. SOA executes the SQL statement defined in the interaction and passes it to a resource adapter. Perform the following to create the third-party adapter.

1. From the **Projects** area, on the left side, double-click the `composite.xml`. At the bottom of the visual editor, click the **Design** tab, if necessary. [Figure 5-4](#) shows the Composite view in the visual editor.

Figure 5-4 Composite View

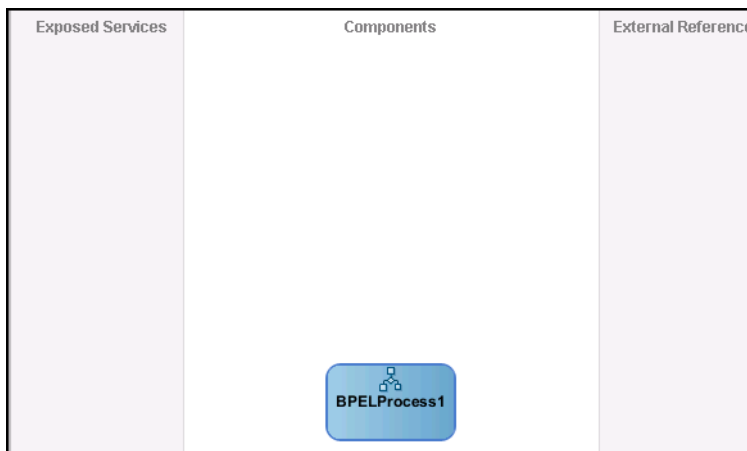

2. Drag a third-party adapter into the **Exposed Services** lane of the visual editor, as shown in [Figure 5-5](#).

Figure 5-5 Third-Party Adapter

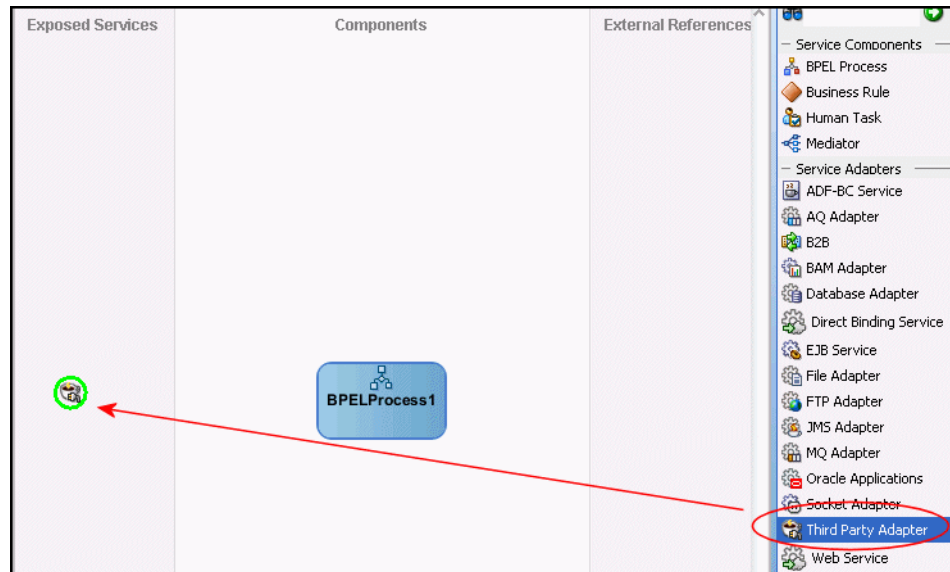

When you drag the third-party adapter into JDeveloper, the Create Third Party Adapter Service screen is displayed as shown in [Figure 5-6](#).

Figure 5-6 Create Third-Party Adapter Service

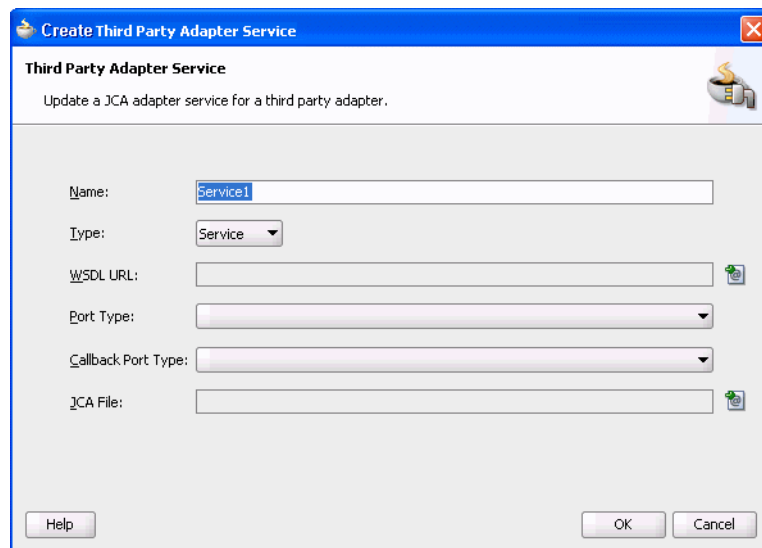

3. Click the button next to the **WSDL URL** field and browse to the WSDL file you are using.
4. In the **Type** list, select **Service**.
5. Click the button next to the **JCA File** field and browse to the binding file you are using.
6. Click **OK** to close. You should now have a composite design as shown in [Figure 5-7](#).

Figure 5–7 Ready to Create BPEL Process (Composite View)

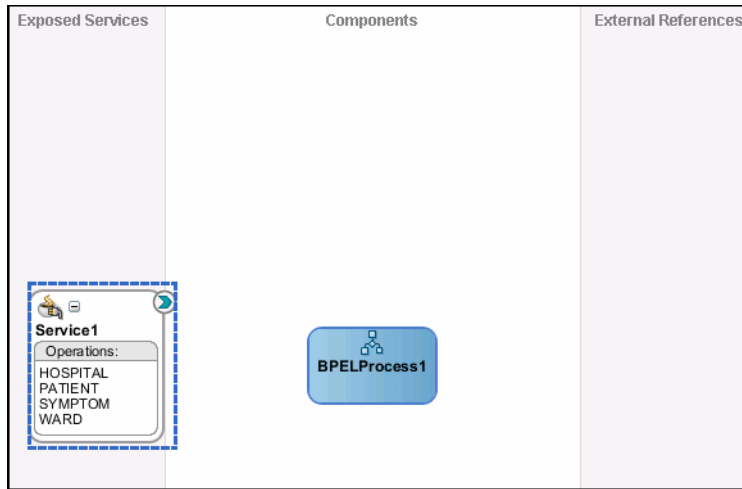

Continue with [Design the BPEL Inbound Process](#).

5.2.1.3 Design the BPEL Inbound Process

Before you begin to design the inbound process procedure, you may need to configure some activation spec properties in the binding (jca) file. For more information on working with the inbound binding file, see [Configuring the Binding File](#).

Do the following to define the BPEL inbound process.

1. In the Composite, connect the BPEL process to the third-party adapter as shown in [Figure 5–8](#).

Figure 5–8 Connect to Third-Party Adapter

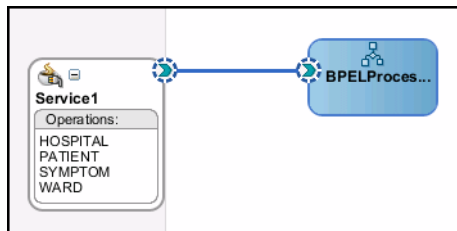

2. Double-click the BPEL Process.
3. From the Component Palette, BPEL Process Activities section, drag a Receive and an Assign process into the editor as shown in [Figure 5–9](#).

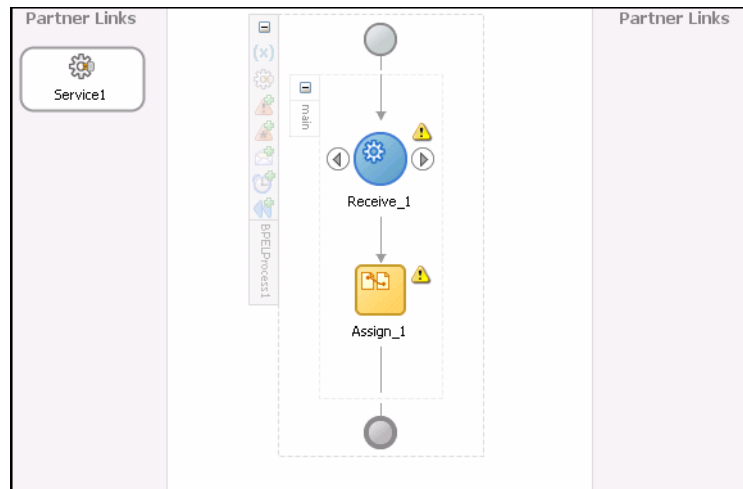
Figure 5–9 Inbound Process

4. In the Visual Editor, connect the Receive activity to the third-party adapter service (*Service1*). The Edit Receive dialog box is displayed as shown in [Figure 5–10](#).

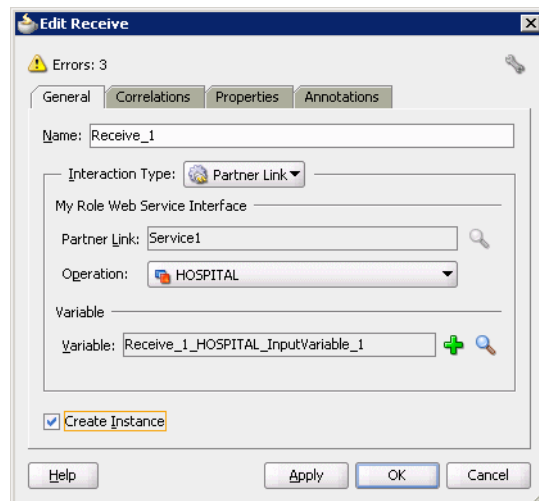
Figure 5–10 Receive Properties

5. Do the following in the Edit Receive dialog box:
 - Create the variable. Click the plus sign to the right of the **Variable** field, then click **OK** in the Create Variable dialog box that is displayed.
 - Make sure that the **Create Instance** check box is selected.
6. Click the (x) in the visual editor as shown in [Figure 5–11](#). The Variables screen is displayed.

Figure 5–11 Add Variable

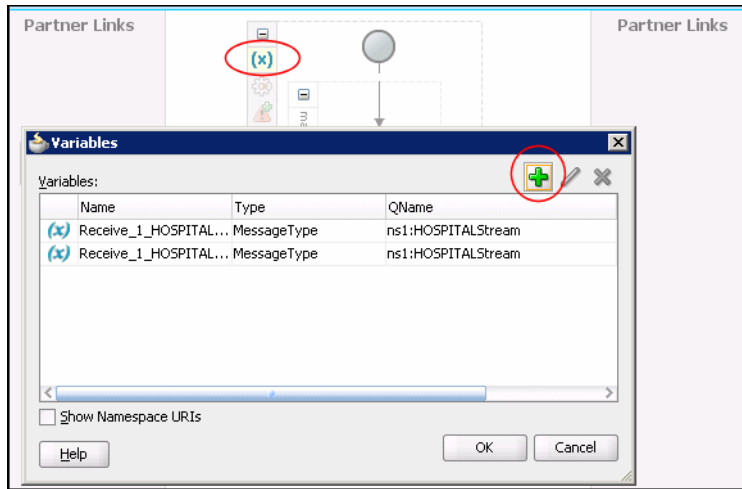

7. In the Variables screen, click the Plus sign to open the Create Variable screen.
8. In the Create Variable screen, select **Message Type**, and then click the icon next to the field to open the Type Chooser.
9. In the Type Chooser, expand the files in the tree until you find the HOSPITALStream under the Message Types folder as shown in [Figure 5–12](#).

Figure 5–12 Type Chooser

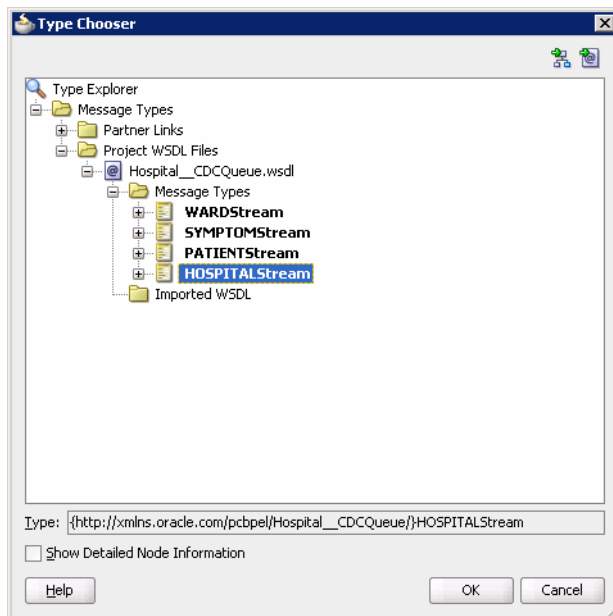

Click **OK**, then click **OK** in the Create Variable screen.

10. Double-click the Assign_1 process to open the Assign screen.
11. From the Assign screen, click the plus sign at the top as shown in and select **Copy Operation**. The Create Copy Operation screen is displayed as shown in [Figure 5–13](#).

Figure 5–13 Edit Copy Operation

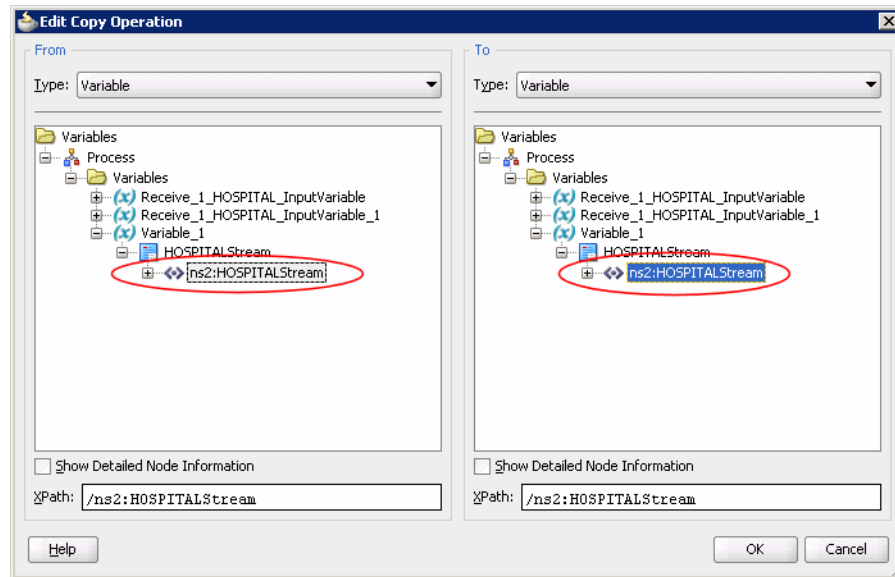

12. From the Create Copy Operation screen, for both the **From** and **To** sides, expand Variable_1, then HOSPITALstream, then select ns2:HOSPITALstream as shown in Figure 5–13.
13. Click **OK** to close the Create Copy Operation screen, then click OK to close the Assign screen and accept the information.
14. [Deploy the Project.](#)

5.2.1.4 Deploy the Project

Perform the following to deploy the project to the Oracle Application Server:

1. From the Application Navigator, right-click the project and find **Deploy** and then select the project you are deploying.
2. From the Deploy wizard, select **Deploy to Application Server**.
3. Continue to click **Next** till the end of the wizard and then click **Finish** to deploy.

5.2.2 Run-time Configuration

This section describes how to test the project and run it to see that the inbound process is executed successfully. By using the XML utility, you call an event in Oracle Connect that is defined in the file adapter you created. See [Triggering the Event using the XML Utility](#). Because this event is called from Oracle Connect it is an inbound event. Events that originate with SOA services in the OracleAS, it is an outbound event.

5.2.2.1 Triggering the Event using the XML Utility

Use the XML utility to create an SQL statement to trigger the event you are requesting. Do the following to trigger the event.

1. From the Start menu, select **All Programs**, then **Oracle**, then **Server Utilities**, and then **XML Utility**. The XML Utility is displayed.

Figure 5–14 Trigger for Inbound Process

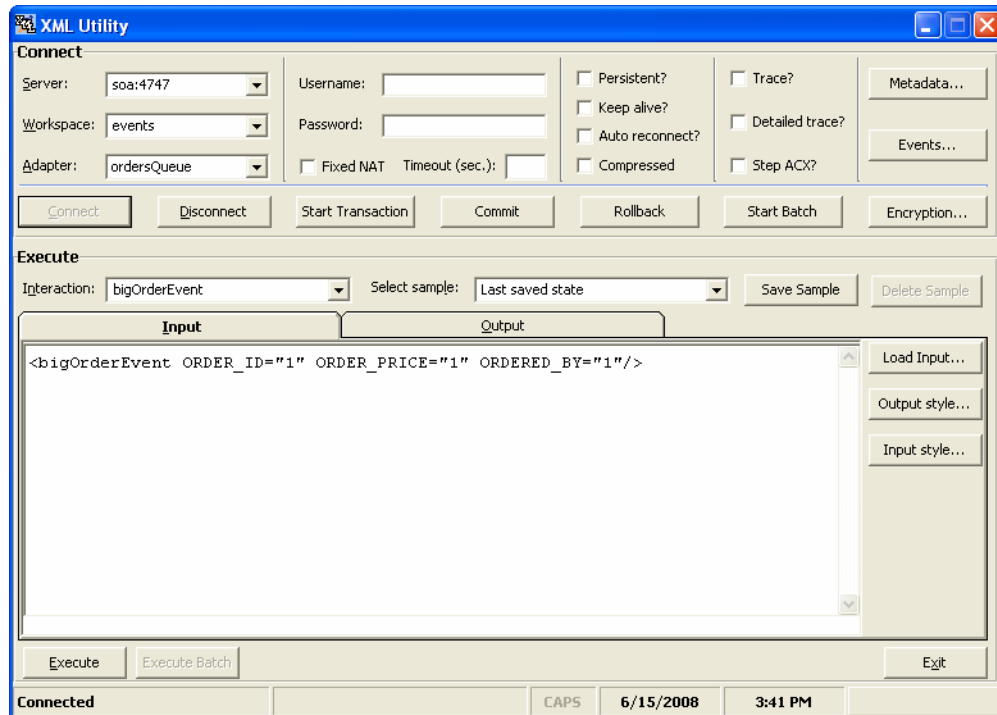

2. Enter the following information in the Connect section of the XML utility:
 - **Server:** The name of the machine where the OracleAS CDC Adapter for VSAM is located.
 - **Workspace:** The name of the workspace where the OracleAS CDC Adapter for VSAM is located. A list of available workspaces is shown in the list for this field. The workspaces are defined in Oracle Studio.
 - **Adapter:** The name of the OracleAS CDC Adapter for VSAM. A list of available adapters is shown in the list for this field. The adapters are defined in Oracle Studio.
3. Click **Connect** to connect to the selected machine.
4. In the **Interaction** field, enter the name of the interaction to call. This is defined in Oracle Studio.
5. In the **Input** window, enter a statement to call the interaction. You can see an example in the above figure.
6. Click **Execute**. If successful, you get a return similar to the following example:

```
<?xml version="1.0"?>
<bigOrderEvent ORDER_ID="1" ORDERED_BY="1" xmlns="noNamespace://ordersQueue"/>
```

5.3 Mediator Inbound Process

This section describes how to create a Mediator inbound process that connects to a OracleAS CDC Adapter for VSAM.

You use JDeveloper to configure a process with Mediator. This section describes how to create a Mediator inbound process for CDC resource adapters using JDeveloper. The following topics describe how to create a Mediator inbound process.

- [Beginning Tasks](#)
- [Create a Mediator Inbound Process](#)
- [Use a Third-Party Adapter for the Inbound Process](#)
- [Create a File Adapter](#)
- [Design an Inbound Mediator](#)
- [Create Mapping Rules and Map the Files](#)
- [Deploy the Project](#)

5.3.1 Beginning Tasks

Before you design the inbound process, you must perform the following:

- Integrate the OracleAS CDC Adapter for VSAM. See [Configuring the VSAM CDC Adapter In the Application Server](#) for more information.
- Configure the connection for the J2CA CDC resource adapter. You do this by creating a connection factory. See [Configuring the JCA Configuration Files for the OracleAS CDC Adapter for VSAM](#) for information on how to do this.
- Create the WSDL and binding file for the interaction. You do this in Oracle Studio before you begin to build your endpoint in JDeveloper. Oracle Studio create the WSDL and binding (jca) files automatically based on the interaction you create. See [Creating JCA Configuration Files](#) for information on creating these files.

5.3.2 Create a Mediator Inbound Process

Perform the following to create an inbound Mediator project.

1. In JDeveloper, create a new SOA project
2. Right-click the SOA project and select **New**. The New Gallery is displayed as shown in [Figure 5-15](#).

Figure 5–15 New Gallery

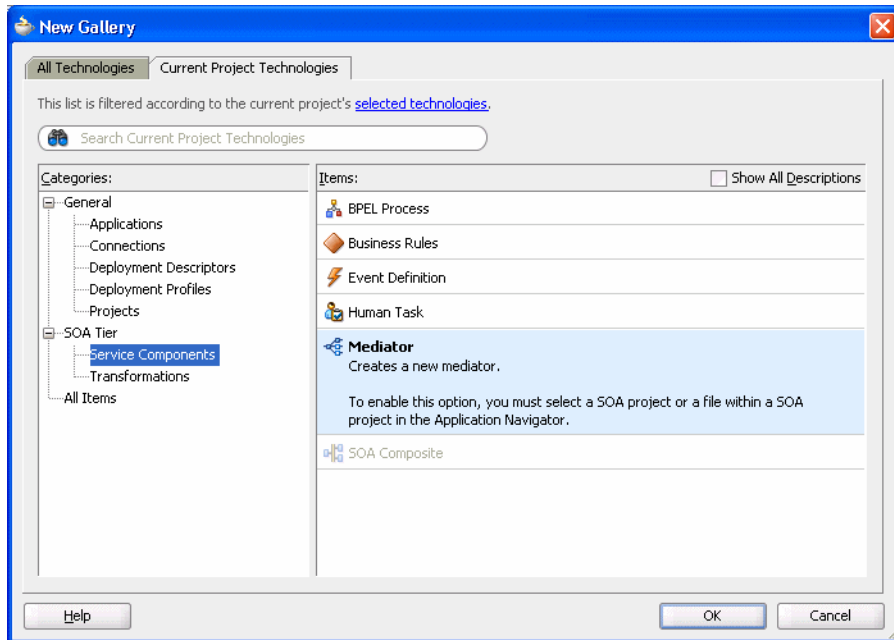

3. In the **Categories** list, expand **SOA Tier** and select **Service Components**.
4. From the **Items** list, select **Mediator** then click **OK**. The Create Mediator screen is displayed as shown in [Figure 5–16](#).

Figure 5–16 Mediator

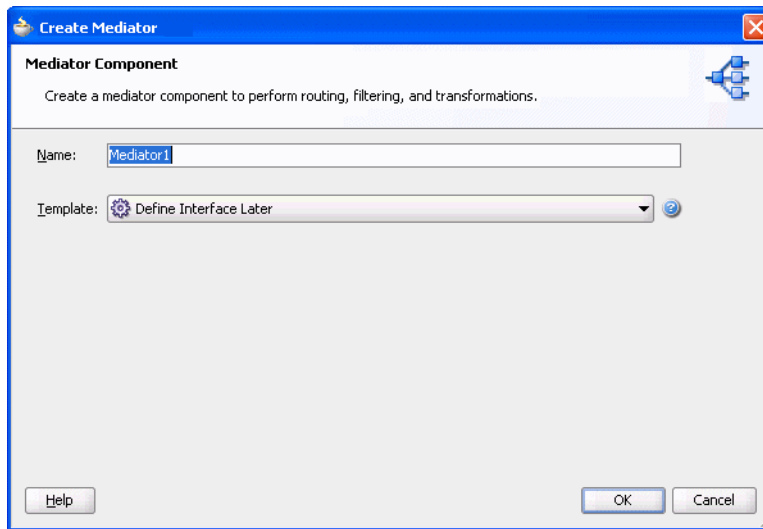

5. Enter the following in the BPEL Process screen:
 - Enter a name for the Mediator process, for example **MedInbound1**.
 - From the Template list, select **Define Service Later**.
6. Click **OK**. The Mediator process is displayed in the visual editor. Continue with [Use a Third-Party Adapter for the Inbound Process](#).

5.3.3 Use a Third-Party Adapter for the Inbound Process

You use a third-party adapter as a partner link to create the inbound Mediator. SOA executes the SQL statement defined in the interaction and passes it to a resource adapter. Perform the following to create the third-party adapter.

1. From the **Projects** area, on the left side, double-click the `composite.xml`. At the bottom of the visual editor, click the **Design** tab, if necessary. [Figure 5-17](#) shows the Composite view in the visual editor.

Figure 5-17 Composite View

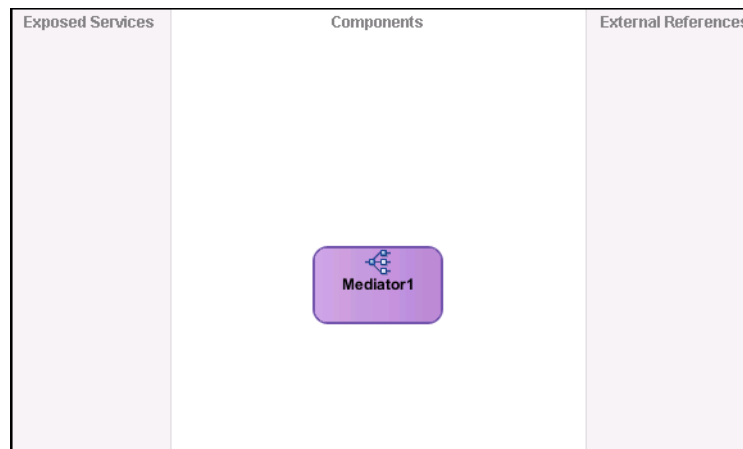

2. Drag a third-party adapter into the **Exposed Services** lane of the visual editor, as shown in [Figure 5-18](#).

Figure 5-18 Third-Party Adapter

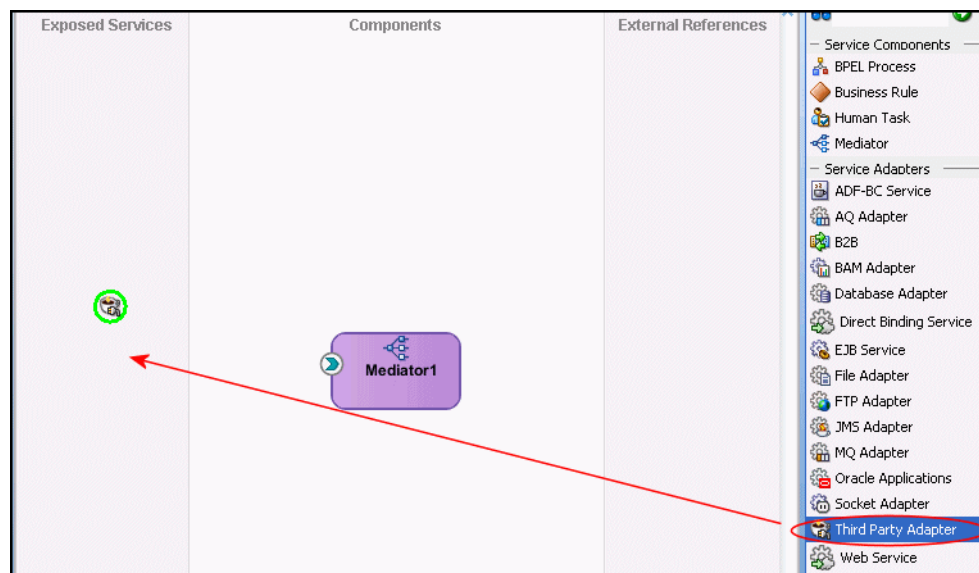

When you drag the third-party adapter into JDeveloper, the Create Third Party Adapter Service screen is displayed as shown in [Figure 5-19](#).

Figure 5–19 Create Third-Party Adapter Service

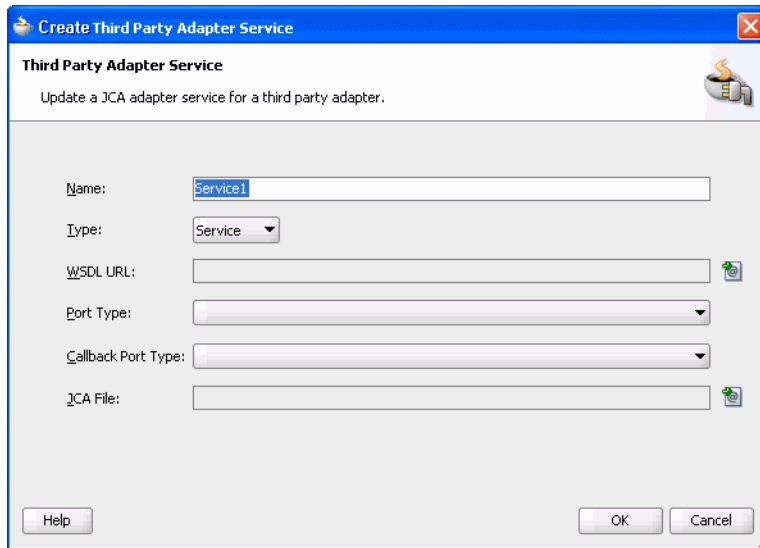

3. Click the button next to the **WSDL URL** field and browse to the WSDL file you are using.
4. In the **Type** list, select **Service**.
5. Click the button next to the **JCA File** field and browse to the binding file you are using.
6. Click **OK** to close. You should now have a composite design as shown in [Figure 5–20](#).

Figure 5–20 Ready to Create Mediator (Composite View)

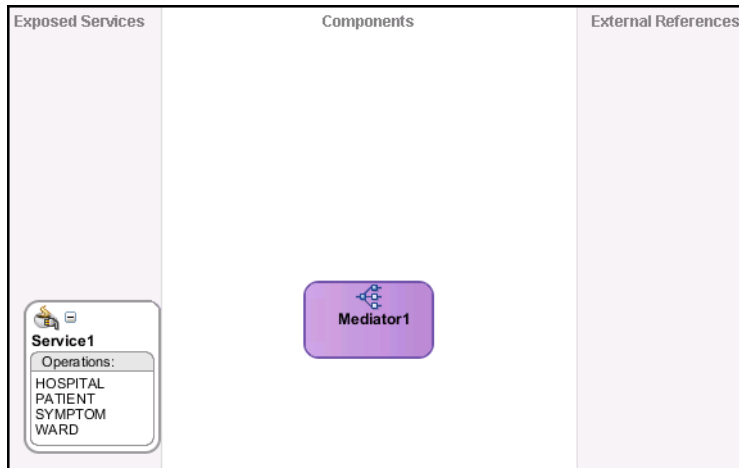

Continue with [Create a File Adapter](#).

5.3.4 Create a File Adapter

Perform the following to create a file adapter.

1. In the Composite, connect the Mediator to the third-party adapter.

2. From the component pallet, SOA section, on the right, drag a file adapter into the **External References** lane of the visual editor. The Adapter Configuration wizard is displayed.
3. In the first screen of the Adapter Configuration wizard, enter a name for the adapter service, and click **Next**.
4. In the Adapter Interface screen, select **Import an existing WSDL**. Select the same WSDL file as you selected in [Use a Third-Party Adapter for the Inbound Process](#). [Figure 5–21](#) shows the Adapter Interface screen.

Figure 5–21 File Adapter

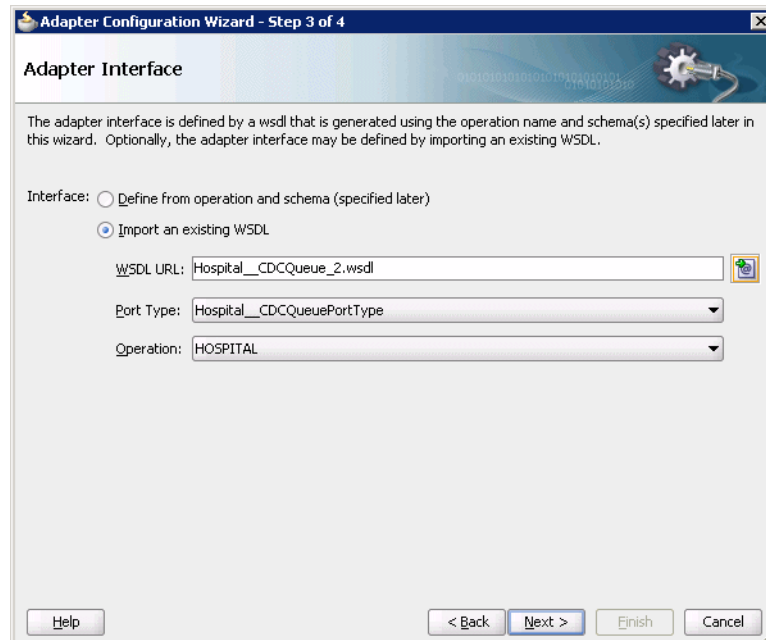

5. In the Operation screen, select **Write File** as the **Operation Type**.
6. In the File Configuration screen, enter a path to the folder where the files are written , and also enter the file naming convention as shown in [Figure 5–22](#).

Figure 5–22 File Configuration Screen

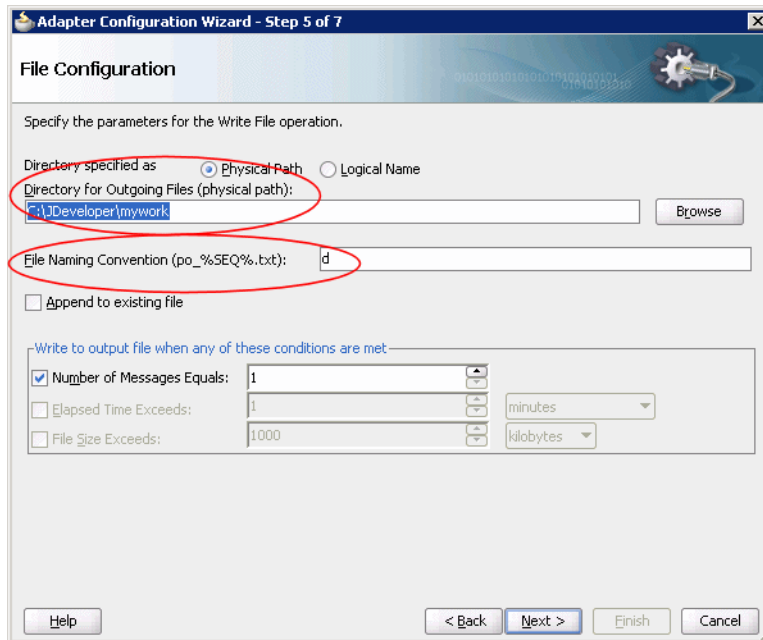

7. Click **Next** to use the default settings for each of the remaining screens in the wizard. When you get to the end click **Finish**.
8. Connect Mediator to the file adapter.
9. In the Choose Operations screen, select the Hospital for both operations. Click **OK**. Continue with [Design an Inbound Mediator](#).

5.3.5 Design an Inbound Mediator

In this step, you design the BPEL process. Perform the following to design the inbound Mediator.

1. In the Composite, double-click the Mediator.
2. Expand the Filter Expression as shown in [Figure 5–23](#).

Figure 5–23 Filter Expression

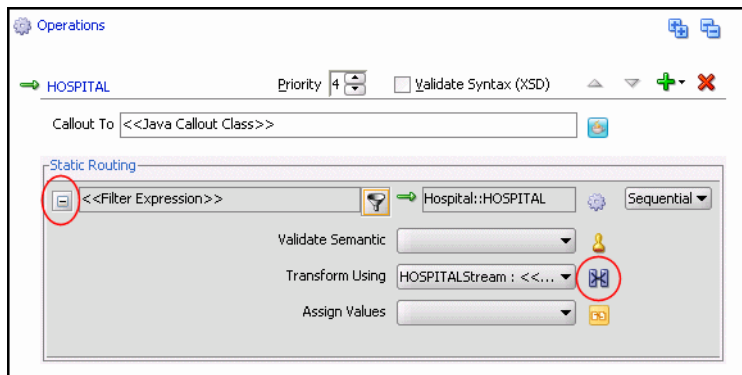

3. Continue with [Create Mapping Rules and Map the Files](#).

5.3.6 Create Mapping Rules and Map the Files

You must perform the following steps to create mapping files and map the files.

1. In the Filter Expression screen, click the icon next to the **Transform using** field as shown in Figure 5-23. The Request Transformation Map screen is displayed as shown in Figure 5-24.

Figure 5-24 Request Transformation Map

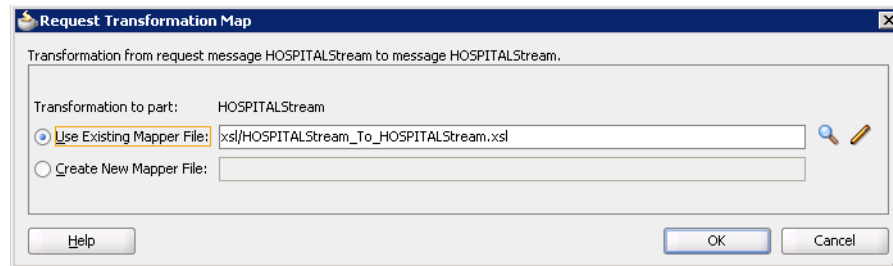

2. In the Request Transformation Map, select **Create New Mapper** file. Use the default value.
3. Click **OK**.
4. In the visual editor, click the **HOSPITALStream to HOSPITALStream** tab. This displays the mapper.
5. Connect the `legacyReq:HOSPITALStream` elements. This is shown in red in Figure 5-25. Then expand the nodes to see the connections.

Note: The red line does not appear in JDeveloper.

Figure 5-25 Mapper Screen

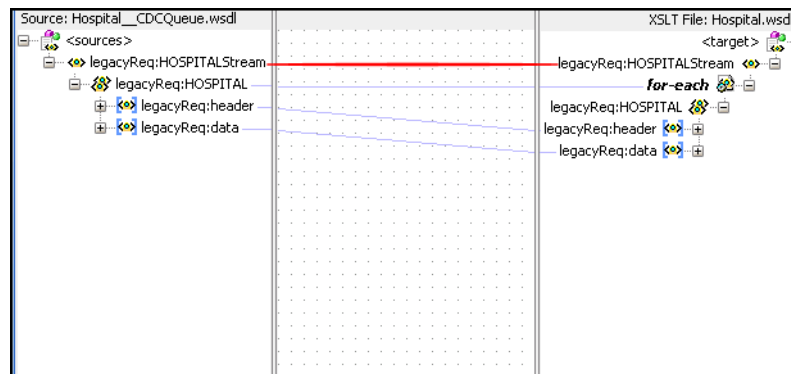

6. Save and then [Deploy the Project](#).

5.3.7 Deploy the Project

Perform the following to deploy the project to the Oracle Application Server:

1. From the Application Navigator, right-click the project and find **Deploy** and then select the project you are deploying.
2. From the Deploy wizard, select **Deploy to Application Server**.
3. Continue to click **Next** till the end of the wizard and then click **Finish** to deploy.

Run-time Tasks and Troubleshooting

Run-time tasks are executed after you install and configure the OracleAS CDC Adapter for VSAM. This chapter describes how to perform basic maintenance tasks, and make changes to CDC solutions. These tasks include:

- [Adding and Removing Tables](#)
- [Handling Metadata Changes](#)
- [Staging Area Maintenance](#)
- [Monitoring the Change Data Capture](#)
- [Daemon Life-Cycle Tasks](#)
- [Resolving Communication Errors](#)
- [Resolving Specific Errors](#)

6.1 Adding and Removing Tables

After you deploy the OracleAS CDC Adapter solution and start working with it, you may want to change the tables that are being monitored. You do this in the CDC Solution perspective of Oracle Studio. The following describes the main steps that you must follow to make changes to the table. During this operation you must go back and change some configurations you made when you set up the OracleAS CDC Adapter solution during design time. Do the following to change tables:

1. From the **Start** menu, select **Start, Programs, Oracle**, and then select **Studio**.
2. From the **Window** menu, click the **Open Perspective** button and select **CDC Solution**.
3. In the Getting Started pane, under Recent projects, click the OracleAS CDC solution that you are changing.

If you do not see the CDC solution you want to edit in the list under Recent projects, click Open an existing project and select your solution from the list in the dialog box that is displayed.

4. Click **Implement**.
5. Under the **Stream Service Configuration** section, click **Stream Service**.
6. In the first screen of the Stream Service wizard, you can change the location of the change files or click **Next** to make changes to the tables to be captured.
7. Select one or more tables from either pane.

- Select a table from the right pane then click the left arrow to move a selected table into the left pane and remove it from the list of tables to be captured.
 - Select a table from the left pane then click the right arrow to move a selected table into the right pane and add it to the list of tables to be captured.
8. Click **Next**, in the screen displayed, clear check boxes from the columns you no longer want to capture. Select check boxes from columns that are not currently included in the change data capture to include them.
 9. Click **Next**, in the screen displayed, clear and select the check boxes to change the filters used in the change data capture.
 10. Click **Next**, in the final screen you can make changes to the auditing configuration.
 11. Click **Finish** to close the wizard and save the changes.
 12. You must re-deploy the solution for the changes to be recognized at run time. For more information, see [Deploying a Change Data Capture](#).

For more information on configuring the Stream Service, see [Set up the Stream Service](#).

Note: When adding a new table, you must create a corresponding endpoint for capturing changes. For more information, see [Creating JCA Configuration Files](#).

6.2 Handling Metadata Changes

When you make changes to the way an application accesses a VSAM file, you must ensure that the solution recognizes the changes and works with them. This section provides you with a procedure to handle the metadata when working with an OracleAS CDC Adapter for VSAM solution if changes are made after deploying the solution. You should perform these steps at a time when there is little or no activity in the system. If you want to receive new events with a new structure, consume the changes for the table you are updating before carrying out any the steps in this process. Do the following to handle any changes to the metadata:

1. Deactivate the Solution workspaces using the CDC Solution perspective in Oracle Studio.
2. Update the metadata in the VSAM CICS data source and Staging Area by doing *one* of the following:
 - If you made manual changes to the CDC solution after deployment, or if you do not want to redeploy the solution, then on the Router's (Staging Area) computer, do the following:
 - a. Run Oracle Studio, and open the Design perspective.
 - b. Edit the Metadata for the Router's Data source.
 - c. Expand the table list and edit the metadata for the table.

If you are adding a new column, you must add it to the end of the `COL-UMN` list. This operation can also be done using the Source view. Select the correct data type.

If you are modifying a data type, you must select the corresponding data type when making the modification.

- d. Save the metadata.

- e. Repeat this procedure on the CDC adapter computer for the VSAM CICS data source.

For more information, see [Importing the Metadata](#).

- For cases where you can redeploy the solution:
 - a. Run Oracle Studio, and open the CDC Solution perspective.
 - b. Open the CDC solution project.
 - c. Click **Implement** and then click **Stream Service**.
 - d. Run the wizard. Ensure that you are using the modified metadata.
 - e. Re-deploy the solution, but do not activate it.

For more information, see [Deploying a Change Data Capture](#).

3. Delete the physical files that represent the modified tables from the Staging Area. Do *not* delete the SERVICE_CONTEXT and CONTROL_TABLE files.
4. Reactivate the solution using Oracle Studio. For more information, see [Activating and Deactivating Solution Workspaces](#).

6.3 Staging Area Maintenance

The Staging Area files for the OracleAS CDC Adapter solution are DISAM files that store changes until the client application consumes them. When you delete old changed records they are actually only marked as deleted. New changes continue to be written to the deleted records.

In busy production sites the DISAM files can get very large, which can affect the performance of the system.

To ensure that system performance is not degraded, you should defragment the Staging Area files to better maintain the Staging Area repository. Use the following procedures and suggestions when you perform the defragmentation of the staging area:

- Defragment the DISAM files at least once a week. The frequency can vary depending on the amount of changes in the staging area.
- In addition to defragmenting the staging area files, you should also check for corrupt DISAM files.
- You should perform the maintenance processes when the lowest possible activity in your system occurs.

To defragment and maintain the staging area, use the DCHECK and DPACK DISAM utilities. The DCHECK utility is used to check for corruption of DISAM files and rebuild the bad indexes and the DPACK utility defragments the DISAM files and rebuilds them without the deleted records. This reduces the size of the files and ensures that the DISAM files contain only active and relevant records.

Do the following to perform the maintenance activities:

1. Deactivate the OracleAS CDC Solution with the staging area you working with. For more information, see [Activating and Deactivating Solution Workspaces](#).
2. Run the DCHECK utility on each file to ensure that it is not corrupted. For example, at the command prompt enter the following to check the DIASM file that represents the table called **employees**.

```
dcheck employees
```

If the file is corrupt you can use the `-b` switch to rebuild all indexes.

3. Defragment each file using the DPACK utility. For example, at the command prompt enter the following to defragment the DIASM files that represent the tables called **employees** and **salaries**.

```
dpack employees
dpack salaries
...
```

4. Reactivate all solutions. For more information, see [Activating and Deactivating Solution Workspaces](#).

6.4 Monitoring the Change Data Capture

After you deploy the OracleAS Change Data Capture, you can monitor its progress. Monitoring provides you with information about the OracleAS CDC Adapter's status, troubleshooting and tuning. This section contains the following topics that explain monitoring in a CDC.

- [Service Context Table](#)
- [Monitoring the Status](#)

6.4.1 Service Context Table

A control table is maintained by the event router that reports its current state and other important statistics. It can be accessed with any tool that supports SQL access.

The control table is called SERVICE_CONTEXT. This table has a single row with the following columns:

Table 6-1 SERVICE_CONTEXT Table Structure

Column Name	Data Type	Description
context	string (32)	The context value of the last change record in the most recently committed transaction. Use this value to synchronize retrieval of transactions among different tables.
agent_context	string (64)	This is the agent context that the staging area would return to if it were to restart for whatever reason. The agent context value is calculated as follows: <ul style="list-style-type: none"> ■ If there are pending uncommitted transactions, the agent_context value is the agent context of the first event of the oldest uncommitted transaction. ■ If there are no pending uncommitted transactions the agent context of the last event of the most recently committed transaction, prefixed with 'next' and indicates that on recovery, the next event after that is to be processed. The staging area maintains an internal agent_context that is more advanced than the one stored in the SERVICE_CONTEXT table. The staging area uses memory to speed up change processing and when stopped it may revert back to an earlier agent context. The amount of extra work depends on the existence of long-running transactions.
start_time	timestamp	The time when the staging area started.
status	string (16)	Staging area status. For more information, see Monitoring the Status .

Table 6–1 (Cont.) SERVICE_CONTEXT Table Structure

Column Name	Data Type	Description
sub_status	string (64)	A second level status. For more information, see Monitoring the Status .
status_message	string (80)	Message that is returned that describes the staging area status.
status_time	timestamp	The time that the status is updated.
completed_transactions	uint4	Number of transactions processed.
active_transactions	uint4	Number of transactions in progress (in memory, not yet committed or rolled back).
timedout_transactions	uint4	Number of transactions that have timed out (were in memory for too long, declared to have timed out and written to a file).
rolledback_transactions	uint4	Number of rolled back transactions.
processed_change_events	uint4	Number of change events written out.
deleted_change_events	uint4	Number of change events deleted from change table.
bytes_written	uint4	Accumulated size in bytes of change records written.
opened_files	uint4	Current number of physically opened files by the staging area.
opened_files_virtual	uint4	Current number of logically opened files by the staging area.
memory_usage	uint4	Amount of memory currently allocated for staging.
node_id	uint4	A two-digit identifier with the same value as the <code>nodeID</code> config property when in multi-router mode. In regular mode, this column has no value.
last_transaction_timestamp	string (26)	The time of the last transaction.
Version	uint4	The version number for the router.
errors	uint4	Total number of errors reported.
Reduced_transactions	uint4	The number of transactions reduced to disc.
compensation_records	uint4	The number of compensation records captured.

The CONTROL table is also used by the event router to persist its state for purpose of recovery. This table must not be modified by the users.

6.4.2 Monitoring the Status

The following table describes the status for the CDC adapters when they are running. The status is defined as a state in the SERVICE_CONTEXT table. The table describes the different statuses available for a CDC adapter.

Table 6–2 SERVICE_CONTEXT Status States

State	Sub State	State Details	Description
Active	Processing	<ul style="list-style-type: none"> ▪ Reads the change events ▪ Writes the change events ▪ Reduces the timed-out transaction to disc ▪ Deletes any expired change events 	The router is connected to the CDC agent and is processing or waiting for the change events.
	Idle	Waits for new change events	The router's agent reaches the end of its journal and does not have any new change events.
error	router.discWriteError	Detailed error text	This indicates that the change router operation involving writing to disk failed. The most common reason is not enough disk space. Other reasons such as permissions, wrong path, or locking can also cause this.
	component.error	Detailed error text	The prefix <i>component</i> (agent/Router) indicates where the error happened. The <i>error</i> in the sub_state column identifies the error.
	<p>This error type occurs in agents and routers.</p> <p>The following are the errors that are returned for this error type:</p> <ul style="list-style-type: none"> ▪ xmlError ▪ requestError ▪ noActiveConnection ▪ resourceLimit ▪ noSuchResource ▪ authenticationError ▪ noSuchInteraction ▪ noSuchConnection ▪ notImplemented ▪ autogenRejected ▪ resourceNotAvailable ▪ authorizationError ▪ configurationError ▪ noSuchStream ▪ temporarilyUnavailable ▪ dataError ▪ interventionRequired 		
	Disconnected	Detailed error text	This indicates that the change router operation with the CDC agent failed and cannot be restored.

Table 6–2 (Cont.) SERVICE_CONTEXT Status States

State	Sub State	State Details	Description
Paused	N/A		Operator manually paused the change router using the <code>sqlrtr_pause</code> control reset.
Down	N/A	Down message (orderly shutdown or abort message)	This indicates that the change router is not running.

6.5 Daemon Life-Cycle Tasks

Most of the daemon run-time tasks between Oracle Application Server and OracleAS CDC Adapter for VSAM are carried out using Oracle Studio, which is used to monitor the daemon and server activity and control what happens to the daemon and server processes.

See Also: [Appendix B, "Advanced Tuning of the Daemon"](#) for details about the configuration settings.

This section contains the following topics:

- [Starting the Daemon](#)
- [Shutting Down the Daemon](#)
- [Monitoring the Daemon During Run time](#)
- [Daemon Logs](#)

6.5.1 Starting the Daemon

The daemon is started when OracleAS Adapter for VSAM is installed. In case you have shut down the daemon, as described in [Shutting Down the Daemon](#), you can restart the daemon as described in the following task.

Note: The daemon is started on the IBM z/OS platform. It cannot be started remotely using Oracle Studio.

6.5.1.1 Task: Starting the Daemon

Activate `INSTROOT.USERLIB (ATTDAEMN)` as a started task to invoke the daemon. For example, in the SDSF screen, enter the following command:

```
'/s ATTDAEMN'
```

Where `INSTROOT` is the high-level qualifier where Oracle Connect is installed.

6.5.2 Shutting Down the Daemon

To shut down the daemon use Oracle Studio, as follows:

1. From the **Start** menu, select **Start, Programs, Oracle**, and then select **Studio**.
2. Expand the **Machines** folder.
3. Right-click the computer defined in [Setting Up the IBM z/OS Platform in Oracle Studio](#) and select **Open Runtime Perspective**.

4. In the Runtime Explorer, right-click the daemon you want to shut down and select **Shutdown Daemon**.

6.5.3 Monitoring the Daemon During Run time

Use the Runtime Manager perspective of Oracle Studio to monitor the daemon during run time.

Perform the following steps:

1. From the **Start** menu, select **Start, Programs, Oracle**, and then select **Studio**.
2. Right-click the computer defined in [Setting Up the IBM z/OS Platform in Oracle Studio](#), and select **Open Runtime Perspective**.

You can manage the daemon by expanding the relevant node, daemon, workspace or server process, as described in the following sections.

6.5.3.1 Daemon (Computer) Options

Right-click the daemon to display the options available for it, including the ability to display the daemon log.

The following table lists the available daemon options:

Table 6–3 Daemon Options

Option	Description
Edit Daemon Configuration	Opens the daemon editor, which enables you to reconfigure the daemon. For more information, see Appendix B, "Advanced Tuning of the Daemon" for details about the configuration settings.
Status	Checks the status of the daemon. The information about the daemon includes the name of the daemon configuration used, the active client sessions, and logging information.
Reload Configuration	Reloads the configuration after any change. Servers currently started are not affected by the changed configuration. For more information, see Appendix B, "Advanced Tuning of the Daemon" for details about the configuration settings.
View Log	Displays the daemon log. For more information, see Daemon Logs on page 6-10.
View Events	Displays the daemon events log.
Daemon Properties	Displays information about the computer where the daemon is running, such as the physical address and any user name and password needed to access the computer.
Recycle servers	Closes all unused servers and prepares all active servers to close when the client disconnects. New connection requests are allocated with new servers.
Kill servers	Immediately closes all active and unused servers. Note: It is recommended to use this option with caution, as it may lead to data loss.
Shutdown Daemon	Shuts down the daemon on the computer.
Rename	Enables changing the name of the daemon displayed in the Runtime Explorer.
Remove	Removes the daemon from the Runtime Explorer.

Table 6–3 (Cont.) Daemon Options

Option	Description
Refresh	Refreshes the display.

6.5.3.2 Workspace Options

Right-click a workspace to display the options available for the workspace, including the ability to display the workspace log.

The following table lists the available options:

Table 6–4 Workspace Options

Option	Description
Edit Workspace Configuration	Opens the daemon editor to enable you to reconfigure the workspace. For more information, see Advanced Tuning of the Daemon for details about the configuration settings.
Status	Checks the status of the workspace whether it is available or not.
Reload Configuration	Reloads the configuration of the workspace after any change. Servers currently started are not affected by the changed configuration.
View Log	Displays the log for all servers for the workspace. For more information, see Daemon Logs
View Events	Displays the workspace events log.
Recycle Servers	Closes all unused servers and prepares all active servers to close when the client disconnects. New connection requests are allocated with new servers.
Kill Servers	Immediately closes all active and unused servers. Note: Use this option with caution, as it may lead to data loss.
Remove	Removes the selected workspace from the Runtime Explorer.
Disable	Disables the selected workspace.
Refresh	Refreshes the display.

6.5.3.3 Server Options

Right-click a server to display the options available for the server, including the ability to display the server log.

The options available at the server level are listed in the following table:

Table 6–5 Server Options

Option	Description
Status	Checks the status of the server. The information about the server includes the server mode and the number of active client sessions for the server.
View Log	Displays the server log. For more information, see Daemon Logs on page 6-10.

Table 6–5 (Cont.) Server Options

Option	Description
View Events	Displays the server events log.
Kill server	Ends the server process, regardless of its activity status. Note: Use this option with caution, as it may lead to data loss.
Refresh	Refreshes the display.

6.5.4 Daemon Logs

Oracle Connect produces many logs that you can use to troubleshoot problems. The daemon manages the following logs:

- Daemon
- Workspace
- Server process

The Runtime Manager perspective of Oracle Studio provides a monitor for these logs as shown in the following figure:

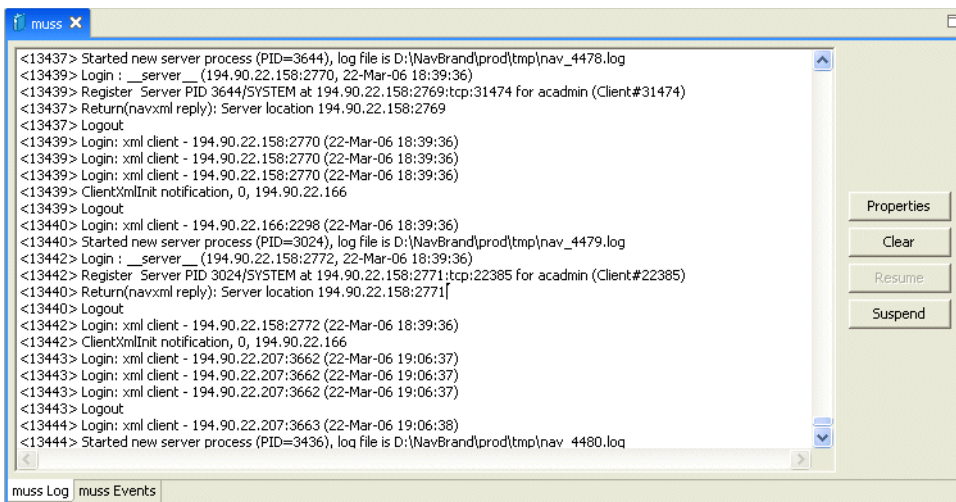

To display the required log, do the following:

1. In Oracle Studio, Runtime Manager perspective, right-click, expand the Daemons folder

If you want to view the workspace log, then expand the daemon with the workspace you want to view.

If you want to view the server, right-click the workspace with the server you want to view.

2. Right click the daemon, workspace, or server and select **View Log**.

Each log is displayed in a different tab. You can browse the different logs by clicking the tab at the bottom of the screen.

6.5.4.1 The Log Monitor

The logs display daemon, workspace, or server events as they happen. You can view the following types of logs in the monitor:

Daemon logs: Display activity between clients and the daemon, including clients logging in and logging out from the daemon.

Workspace logs: Display information about the workspace being used by the client.

Server logs: Display activity between clients and the server process used by that client to handle the client request.

You can change the logging level. To change the logging level, click **Properties**. The following levels of logging are available in the dialog box:

- **none:** The log displays the users that log in and out.
- **error:** The log displays the users that log in and out and any errors that are generated.
- **debug:** The log displays the users that log in and out, any errors that are generated, and any tracing that was configured. For information on configuring the tracing options, see [Logging](#) and workspace [General](#).

You can start and stop the logging display.

- Click **Suspend** to stop collecting logging information.
- Click **Resume** to start collecting logging information.

You can remove the information displayed in the log.

To remove the information, click **Clear**.

If logging is enabled, new information continues to be displayed. The cleared information cannot be viewed again.

6.6 Resolving Communication Errors

When Oracle Studio disconnects from the IBM z/OS computer, the computer is displayed in Oracle Studio with an X in a red circle. If this situation occurs, try to access the computer later.

The following table describes the various scenarios that may exist when Oracle Application Server disconnects from the IBM z/OS computer.

Table 6–6 Scenarios When a Client Is Disconnected

Scenario	Idle (Not Processing a Client Request)	Processing a Client Request
Explicit Disconnect (client explicitly closes connection or client program terminates)	The server is immediately notified of the disconnect and either becomes available for use by another client or terminates (if it is not reusable).	The server does not know that the client has disconnected and continues processing. When processing completes, the server tries to reply to the client and immediately gets an error that the connection was lost. The server either becomes available for use by another client or terminates (if it is not reusable).
Abrupt Disconnect (client closed without proper shutdown or client system hanged and communication disconnected)	The server does not know that the client has disconnected and remains in the idle state. After timing out based on whichever comes first of the value for the client idle timeout daemon workspace parameter or the TCP/IP <code>KEEPALIVE</code> parameter, the server is notified of the disconnect and either becomes available for use by another client or terminates (if it is not reusable).	The server does not know that the client has disconnected and continues processing. When processing completes, the server tries to reply to the client. After an interval (typically several minutes, depending on the TCP/IP configuration), during which the TCP/IP subsystem retries sending the message to the client, the server assumes that the client has terminated and notifies the server that the connection has been closed. The server either becomes available for use by another client or terminates (if it is not reusable).

To troubleshoot client/server communication problems, you must be familiar with the following:

- Daemon configuration settings
- Oracle Connect security
- TCP/IP subsystem. Oracle Application Server Adapter for VSAM uses TPC/IP for internal intercomputer communications.
- System details, such as the account name and password of the administrator account, the IP address of the computers involved and whether a portmapper is being used.

6.7 Resolving Specific Errors

The following error messages relate to errors received from Oracle Connect.

C007: Server initialization failed.

Cause: The daemon failed to start its network service.

Action: Check the processes being run on the system to see whether another daemon or program is using the port specified in the `oc4j-ra.xml` file for the adapter.

Action: Check the TCP/IP subsystem on the current computer by trying to ping it or run FTP or Telnet to or from it.

Action: Check whether the daemon has privileges to use the TCP/IP services on the current computer with the port specified in the `oc4j-ra.xml` file for the adapter.

C008: Setting server event handler failed.

Cause: Internal error.

Action: Contact Oracle Support Services.

C009: IRPCD process has been terminated by user request.

Cause: This message is informational only. The daemon successfully shut down.

Action: No action required.

C00A: Application %s not found.

Cause: The requested workspace does not exist.

Action: Check that the workspace defined in the oc4j-ra-xml file is also defined in the daemon configuration on the IBM z/OS platform. Use the Status option in the Runtime Manager perspective.

C00B: Invalid IRPCD client context.

Cause: A non-Oracle Connect program is trying to connect to the daemon.

Action: Check the processes and stop the relevant process with a system command.

C00C: Daemon request requires a server login.

Cause: A non-Oracle Connect server or program was trying to use a daemon service reserved for Oracle Connect servers.

Action: Check the processes and stop the relevant process with a system command.

C00D: Daemon request requires a client login.

Cause: The requested daemon requires a valid client login, which was not supplied.

Action: Reissue the command and specify a user name and password.

Action: Edit the user profile in Oracle Studio to specify a valid user name and password for the IBM z/OS platform.

See Also: [Setting Up Run-Time User Access to the IBM z/OS Platform.](#)

C00E: Daemon request requires an administrator login.

Cause: The requested daemon service requires an administrative login.

Action: Edit the daemon security in Oracle Studio to specify a valid administrator user name and password.

See Also: [Daemon Security.](#)

C00F: Anonymous client logins are not allowed.

Cause: The daemon is configured to require a valid user name and password, which were not supplied.

Action: Enable anonymous client access in daemon security in Oracle Studio.

See Also: [Daemon Security.](#)

Action: Edit the user profile in Oracle Studio to specify a valid user name and password for the IBM z/OS platform.

See Also: [Setting Up Run-Time User Access to the IBM z/OS Platform.](#)

C010: Anonymous server logins are not allowed.

Cause: Internal error.

Action: Contact Oracle Support Services.

C011: Client has already timed out.

Cause: A server process was started on behalf of a client and the client has timed out before the server completed its startup.

Action: Increase the Connect timeout value for the server workspace in the workspace **General**.

See Also: Workspace [General](#).

C012: Invalid username/password.

Cause: Invalid user name/password supplied when logging on to the daemon.

Action: See the daemon log file because the user name/password were not accepted.

Action: Edit the user profile in Oracle Studio to specify a valid user name and password for the IBM z/OS platform.

See Also: [Setting Up Run-Time User Access to the IBM z/OS Platform](#)

Action: Ensure that the daemon is started from an APF-authorized account that is allowed to check for system user names and passwords.

C014: Client connection limit reached - try later.

Cause: The maximum number of server processes for the workspace has been reached, and none of the active servers could accept the client connection.

Action: Increase the value of the **Number of sub-tasks** in the workspace **Server Mode** tab.

See Also: Workspace [Server Mode](#).

Action: Try running the command later.

C015: Failed to start server process.

Cause: The Oracle Connect daemon failed to start a server process or the started server failed upon starting up.

Action: See the daemon and server logs for the reason the server did not start. For example, you might receive a message with a reason specified in the log file similar to the following: [C015] Failed to start NAVIGATOR server process: No server account name defined for anonymous client; code: -1601: SQL code: 0

Action: If you use impersonation, check the user profile on the client. Also see C069.

To set impersonation: APF authorize all the steplibs in the server script on z/OS computer. For example:

```
setprog... ada622-volume adavol
CICS.CICS.SDFHEXCI - p390dx
INSTROOT.load - 111111
INSTROOT.loadaut - 111111
```

INSTROOT is the high level qualifier where Oracle Connect is installed.

In the **Security** tab of the Navigator workspace, under the daemon node in the Configuration Explorer, select **Use specific workspace account** and clear the **Workspace account** field of all values.

C016: Unexpected server state.

Cause: Internal error.

Action: Contact Oracle Support Services.

C017: Active daemon clients exist. Shutdown canceled.

Cause: One or more clients are still connected to the daemon.

Action: Wait until all the clients log off the daemon and then retry the shutdown operation.

C019: Request is not granted because someone else is locking it.

Cause: A request to lock a resource managed by the daemon was denied because another user has locked the resource.

Action: Wait for the other user to release the resource.

C01A: Lock %s not found.

Cause: A request to free a resource was denied because the caller did not lock that resource (for example, another user shut down the daemon you are working with).

Action: Contact Oracle Support Services.

C01B: Unexpected error in %s.

Cause: Internal error.

Action: Contact Oracle Support Services.

C01C: Cannot update configuration without _APPLICATIONS lock.

Cause: Internal error.

Action: Contact Oracle Support Services.

C01D: Need to lock the application first.

Cause: Internal error.

Action: Contact Oracle Support Services.

C01F: Cannot set configuration of a deleted application.

Cause: Internal error.

Action: Contact Oracle Support Services.

C020: Failed in looking up host name (gethostname())

Cause: Cannot connect to the remote computer.

Action: Check that the name specified for the computer in the oc4j-ra-xml file is correct.

Action: Check that a domain name server (DNS) is available to look up the host name.

Action: Check the TCP/IP subsystem on the computer by trying to ping it or run FTP or Telnet to or from it.

C021: Required variable %s not found

Cause: An environment variable required by the Oracle Connect server was not defined when the server started up.

Action: Check whether the startup script makes any changes to the environment variables used by Oracle Connect.

Action: Check whether the system-defined environment size is sufficiently large for Oracle Connect.

C022: Server failed to connect and register with the daemon.

Cause: An Oracle Connect server started by the daemon was not able to connect or register back with the daemon.

Action: Try to connect again.

Action: Increase the **Connect timeout** value for the server workspace in the Workspace **General** tab.

See Also: Workspace [General](#).

Action: Check that the startup script for the workspace launches the correct version of Oracle Connect.

Action: Increase the value of the `Set maximum number of servers` and `Maximum` parameter for the `Clients per server limit` in the Workspace **Server Mode** tab.

See Also: Workspace [Server Mode](#).

C023: Call made to unregistered module %d.

Cause: Internal error.

Action: Contact Oracle Support Services.

C024: Failed to create a socket.

Cause: An error occurred within the TCP/IP subsystem.

Action: Check whether you have sufficient system privileges.

Action: Check the TCP/IP subsystem on the computer by trying to ping it or run FTP or Telnet to or from it.

C025: Failed to set socket option %s

Cause: An error occurred within the TCP/IP subsystem.

Action: Check whether you have sufficient system privileges.

Action: Check the TCP/IP subsystem on the computer by trying to ping it or run FTP or Telnet to or from it.

C026: Failed to bind server to port %s

Cause: An Oracle Connect server or daemon was not able to bind to the specified port.

Action: Check whether another program is holding the port that was specified in the oc4j-ra-xml file for the adapter.

Action: Check whether you have sufficient system privileges.

C027: Cannot create TCP service for %s

Cause: An error occurred within the TCP/IP subsystem

Action: Check the TCP/IP subsystem on the computer by trying to ping it or run FTP or Telnet to or from it.

C028: Unable to register (%s, %d, tcp)

Cause: This error may happen when a portmapper is used (*host:a*) but the portmapper is not available.

Action: Enable the portmapper.

Action: Avoid using the portmapper (by not using *:a* when starting the daemon).

C029: Failed to create a server thread

Cause: Internal error.

Action: Contact Oracle Support Services.

C02A: Server thread failed to start

Cause: Internal error.

Action: Contact Oracle Support Services.

C02B: Stopping the %s server - no client

Cause: A server that was started by the Oracle Connect daemon to service a client did not get a client connection request within one minute. The server terminates.

Action: In most cases, the client was terminated by a user request, so no specific action is required.

Action: If no client can connect to the server, it may be that the server has multiple network cards and the Oracle Connect daemon is not aware of this. In this case, start the daemon with an IP address.

C02C: Unexpected event - a termination signal intercepted

Cause: Internal error.

Action: Contact Oracle Support Services.

C02D: Modified transport, context unknown/lost

Cause: Internal error.

Action: Contact Oracle Support Services.

C02F: Corrupted arguments passed to procedure

Cause: Internal error.

Action: Contact Oracle Support Services.

C030: Unable to free arguments for %s() of %s

Cause: Internal error.

Action: Contact Oracle Support Services.

C031: Cannot register a non-module RPC %s

Cause: Internal error.

Action: Contact Oracle Support Services.

C032: An IRPCD program is required

Cause: Internal error.

Action: Contact Oracle Support Services.

C033: An IRPCD super-server is required for module events

Cause: Internal error.

Action: Contact Oracle Support Services.

C034: An invalid super-server module ID was specified, %d

Cause: Internal error.

Action: Contact Oracle Support Services.

C035: Out of memory

Cause: Not enough memory to service a client request.

Action: Increase process memory quota or add memory to the system.

C036: Failed to register RPC procedure module %s

Cause: Internal error.

Action: Contact Oracle Support Services.

C037: Failed to register an invalid RPC procedure number %x

Cause: Internal error.

Action: Contact Oracle Support Services.

C038: Cannot reregister RPC procedure number %x

Cause: Internal error.

Action: Contact Oracle Support Services.

C042: Remote call to %s failed; %s

Cause: Remote call to API failed.

Action: Check the daemon log file.

Action: If necessary, change the level of detail written to the log file to help resolve the problem.

See Also: Daemon [Logging](#).

C043: Failed to connect to host %s;%s

Cause: The remote host is not correctly defined to Oracle Connect or is not working.

Action: Check the remote computer definition in the oc4j-ra-xml file for the adapter.

Action: Check that the daemon is up on the IBM z/OS platform. Use the Status option in the Runtime Manager perspective.

Action: Check the network connection by trying to ping the host computer or run FTP or Telnet to or from it.

C045: Failed to create a service thread

Cause: The server failed to create a thread to service a client request.

Action: A system or process quota limit has been exceeded. Either increase the quota or lower the **Clients per server limit** value in the Workspace **Server Mode** tab.

See Also: Workspace [Server Mode](#).

C047: %s out of memory

Cause: Not enough memory was available to Oracle Connect to complete a requested operation.

Action: Terminate unnecessary processes running on the server.

Action: Add more memory to the system.

Action: Allow the process to use more memory.

Action: Limit the number of processes the daemon may start. If the demand for servers exceeds the number of available servers, clients get a message telling them the maximum number of servers has been reached and asking them to try again later.

C066: Communication error with the server%s

Cause: Connection to the Oracle Connect daemon or server failed, or an established session with a server has failed.

Action: Check the remote computer definition in the weblogic-ra.xml file.

Action: Check that the daemon is up on the IBM z/OS platform. Use the Status option in the Runtime Manager perspective.

Action: In case of a network problem, check the network connection by trying to ping the host computer or run ftp or telnet to or from it.

C067: Unexpected error occurred in server function %s

Cause: One of the server functions has exited with an exception (such as an abend, or an Invalid Instruction).

Action: Contact Oracle Support Services.

C068: Fail to login daemon

Cause: The daemon is not running on the server computer.

Action: Use the Status in Oracle Studio Runtime Manager perspective to check whether a daemon is running on the server

Action: Have the system administrator reinstall Oracle Connect on the server.

C069: Fail to get server

Cause: The Oracle Connect daemon on the server computer could not start a server process to serve the client. A separate message provides more detail on why the server process could not start.

Action: There are many possible causes of this error. If the cause is not clear from the related message, see the Oracle Connect daemon log file on the server

Action: The resolution to this error is highly dependent on the particular cause. The following are some typical causes and resolutions.

Action: Some process creation quota was exceeded. Either try again later or increase the quota or the other relevant system resources.

Action: The server startup script failed.

Action: The user name given is not allowed to use the requested server. Use an authorized user name.

Action: A limit on concurrent clients for a server has been reached. Try again later.

Action: If you use impersonation, check the user profile on the client. Also see C015.

C06A: Failed to connect to server

Cause: The server assigned to the client did not accept the client connection. A separate message provides more detail about why the server process did not accept the connection.

Action: See the daemon and server log files because the server was not available to accept its assigned client.

C06B: Disconnecting from server

Cause: A network failure, or a server computer failure or a server program failure caused the connection to end. The currently active transaction also is stopped.

Action: Oracle Connect automatically tries to reestablish a connection with a server upon the next SQL command issued against the server. Once the network or computer failure is corrected, the connection to the daemon is reestablished automatically.

C070: Server failed to send reply to the client

Cause: Server terminated unexpectedly.

Action: Unless the client was intentionally stopped (for example, using Control-C), contact Oracle Support Services.

C071: Connection to server %s was disconnected. Cursors state was lost.

Cause: Either a network failure, a server computer failure or a server program failure caused the connection to end. The currently active transaction also is stopped.

Action: Normally, Oracle Connect automatically tries to create a session with the server upon the next attempt to access the server. If the network and server are accessible, the next operation should succeed. Otherwise, the network or server computer should be fixed before connection can be resumed.

Action: In case of a server failure not related to callable user code, contact Oracle Support Services.

C072: Reconnect to server %s

Cause: This is an informational message only. The client has reestablished its connection with the server.

Action: No action is required.

C073: The parameters passed to the admin server are invalid: %s

Cause: Internal error.

Action: Contact Oracle Support Services.

C074: No authorization to perform the requested operation (%s)

Cause: User/account has insufficient privileges.

Action: Grant administrative privileges to the user/account using the Administrator parameter of the Daemon or Workspace **Security** tabs.

See Also: Daemon [Security](#) or Workspace [Security](#).

C075: Failed to register daemon in the TCP/IP service table

Cause: Registration of the daemon in the TCP/IP services file has failed.

Action: Check that the account running the daemon has the permissions to update the TCP/IP services file.

E001: Failed in lock/release operation

Cause: A lock or release operation of a global resource has failed. A separate message provides more details. The separate message specifies the cause of this error.

Action: There are various causes for this error, including lack of sufficient privileges or a system resource shortage.

J0006: Operation on already closed connection was requested

Cause: A request using a connection that was closed was attempted.

Action: Reopen the connection and try again.

J0028: Internal Error: Unknown XML tag %s

Cause: Internal error.

Action: Contact Oracle Support Services.

J0030: Internal Error: Method %s needs to be overwritten

Cause: Internal error.

Action: Contact Oracle Support Services.

J0031: Internal Error: Required attribute %s not found in %s verb

Cause: Internal error.

Action: Contact Oracle Support Services.

J0032: Internal Error: %s ACP object was returned instead of %s as expected

Cause: Internal error.

Action: Contact Oracle Support Services.

J0033: Internal Error: Attempt to work with closed socket

Cause: Internal error.

Action: Contact Oracle Support Services.

J0034: Internal Error: corrupted message; %s bytes read instead of %s as expected

Cause: XML sent from the client to the server has become corrupted.

Action: Check compression settings for XML transferred from the client to the server. If the settings are OK, retry sending the request from the client to the server.

J0035: Internal Error: Invalid redirection address %s returned by daemon

Cause: Internal error.

Action: Contact Oracle Support Services.

J0036: %s: %s

Cause: One of the following errors was received from the server: 0 - server.internalError, 1 - client.xmlError, 2 - client.requestError, 3 - client.noActiveConnection, 4 - server.resourceLimit, 5 - server.redirect, 6 - client.noSuchResource, 7 - client.authenticationError, 8 - client.noSuchInteraction, 9 - client.noSuchConnection, 10 - server.notImplemented, 11 - server.xaProtocolError, 12 - server.xaUnknownXID, 13 - server.xaDuplicateXID, 14 - server.xaInvalidArgument, 15 - client.autogenRejected, 16 - server.xaTransactionTooFresh, 17 - server.resourceNotAvailable, 18 - client.authorizationError, 19 - server.configurationError

Action: Review the server log file to determine the problem.

J0037: Internal Error: No ACP response when %s was expected

Cause: Internal error.

Action: Contact Oracle Support Services.

J0039: Internal Error: ACP root is not found in the XML

Cause: Internal error.

Action: Contact Oracle Support Services.

J0040: Internal Error: Input record is required for interaction %s execution

Cause: Internal error.

Action: Contact Oracle Support Services.

J0048: Invalid metadata type %s is passed to %s function

Cause: A request for metadata was not fulfilled.

Action: Check the validity of the request.

J0050: Key of the put method must be of type string

Cause: In either a GET or PUT operation, the key must be a string.

Action: Change the key used in the operation to a valid key.

J0059: Value %s is invalid for attribute %s

Cause: A request for metadata was not fulfilled.

Action: Check the validity of the request.

J0068: Value must be of type string

Cause: In a PUT operation, the value must be a string.

Action: Change the value used in the operation to a valid value.

J0069: Value must be of type MappedRecord

Cause: In a PUT operation, the value must be a mapped record.

Action: Change the value used in the operation to a valid value.

J0070: Value must be of type MappedRecord[]

Cause: In a PUT operation, the value must be mapped record array.

Action: Change the value used in the operation to a valid value.

J0071: Bad key for mapped record, #element or #element[] is required

Cause: In a PUT operation, the value must be mapped record array.

Action: Change the key used in the record to a valid key.

J0072: Value must be of type Object[]

Cause: In a PUT operation, the value must be mapped record array.

Action: Change the value used in the operation to a valid value.

J0078: In nonpersistent connection and the nonkeep alive encryption is not supported - ignored

Cause: Encryption is not supported for nonpersistent connections.

Action: There is no action to take. This warning can be ignored.

J0079: Invalid argument passed to %s - Argument: %s, Value: %s

Cause: The value pass.

Action: Change the argument used to a number.

Advanced Features of OracleAS CDC Adapter for VSAM

Oracle Connect includes several tuning parameters that can improve performance. Specifically, the daemon can be configured to optimize communication between the IBM z/OS platform and a client. In addition, the binding environment can be tuned to optimize the request handling.

This chapter contains the following topics:

- [Configuring the Daemon for High Availability](#)
- [Configuring a Binding Environment](#)
- [Migration Considerations](#)
- [Security Considerations](#)
- [Transaction Support](#)

7.1 Configuring the Daemon for High Availability

The daemon workspace is responsible for allocating server processes to clients. You can configure a workspace to use a pool of server processes so that a server process is always available for a client request.

Use Oracle Studio to maintain the daemon and the daemon workspace parameters to control the allocation of server processes and their management in a pool.

You can also have several daemon workspace configurations. This lets you create individual workspaces for use with different adapters.

7.1.1 Adding a New Daemon Workspace Configuration

Use Oracle Studio to add a new daemon configuration. You can set up different daemon configurations for different situations.

Carry out the following to add a new daemon workspace configuration:

1. From the **Start** menu, select **Programs, Oracle**, and then select **Studio**.
2. In the Design Perspective Configuration view, expand the **Machines** folder and then expand the machine where you want to add the workspace.
3. Expand the **Daemons** folder. The daemon available on this computer are listed.
4. Right-click **IRPCD** and select **New Workspace**. The New Daemon Workspace screen is displayed.

5. Enter a name for the new workspace and then enter a description, if desired.
6. Select whether to use default settings or copy the properties of an existing workspace.
To copy the properties of an existing workspace, click the Browse button and select the workspace from which you want to copy the properties.
7. Click **Next**. The Select Scenario screen is displayed.
8. Select **Application Server using connection pooling** and click **Next**.
9. Continue through the wizard, entering the required values for the workspace.
10. Click **Finish**.

The workspace is displayed under the IRPCD daemon node.

7.1.2 Editing the Workspace

You edit a workspace by using the tabs described in the following table:

Table 7-1 Workspace Properties tabs

Tab	Description
General	Specifies general information including the server type, the command procedure used to start the workspace, the binding configuration associated with this workspace (which dictates the data sources and applications that can be accessed) the timeout parameters, and logging information (which dictates the data sources and applications that can be accessed), the timeout parameters, and logging information.
Server Mode	Contains the workspace server information including features that control the operation of the servers started up by the workspace and allocated to clients.
Security	Specifies administration privileges, user access, ports available to access the workspace and workspace account specifications.

Use Oracle Studio to access these tabs, as follows:

1. From the **Start** menu, select **Programs, Oracle**, and then select **Studio**.
2. In the Design perspective Configuration view, expand the **Machines** folder and then expand the machine where you want to edit the workspace.
3. Expand the **Daemons** node. The daemon configurations available on this computer are listed.
4. Expand the **IRPCD** node. The daemon workspaces are listed.
5. Right-click the required workspace and select **Open**.
6. Select the tab that contains the information you want to edit. For full details of the tabs and the fields in these tabs, see [Workspaces](#).
7. After editing the workspace, click **Save**.

7.1.3 Configuring the Server Mode

The server mode dictates how the daemon starts new processes. The daemon supports the following server modes:

- **singleClient:** Each client receives a dedicated server process. The account in which a server process runs is determined either by the client login information or by the specific server workspace.

This mode enables servers to run under a particular user account and isolates clients from each other (because each receives its own process). However, this server mode incurs a high overhead due to process startup times and may use a lot of server resources (because it requires as many server processes as concurrent clients).

- **multiClient:** Clients share a server process and are processed serially. This mode has low overhead because the server processes are initialized. However, because clients share the same process, they may impact one another, especially if they issue lengthy queries.

The number of clients that share a process is determined by the Clients per server limit (the maximum number of concurrent clients a server process for the current workspace accepts).

- **reusable:** This is an extension of the single client mode. Once the client processing finishes, the server process does not die and can be used by another client, reducing startup times and application startup overhead.

This mode does not have the high overhead of single client mode because the servers are initialized. However, this server mode may use a lot of server resources (because it requires as many server processes as concurrent clients).

The other modes can be set so that the server processes are reusable by setting the number of times a process can be reused with the `Reuse limit` value (the maximum number of times a particular server process can be reused or how many clients it can serve before it is retired). Reuse of servers enhances performance because it eliminates the need to repeat initializations. However, reuse runs a risk of higher memory leakage over time. The default value for the `Reuse limit` field is `None`, indicating that no reuse limit is enforced.

Set the server mode in the **Server Mode** tab of the daemon workspace editor as shown in the following figure:

Figure 7–1 The Server Mode Tab

When using any of the server modes you can specify a pool of server processes. These server processes are started when the daemon starts and are maintained in a pool. The server processes are available for use by new client requests from the pool, saving initialization time. Instead of starting a new server process each time one is requested by a client, the client receives a process immediately from the pool of available processes. When the client finishes processing, this server process either dies, or if reusable servers have been specified, it is returned to the pool.

You set up a pool of server processes by specifying the following parameters in the Server Mode tab.

- **Port Range:** Select the range for specific firewall ports through which you access the workspace. Determines the range of ports available for this workspace when starting server processes. Use this option when you want to control the port number, so that Oracle Connect can be accessed through a firewall.

Enter the port range in the following fields:

- **From:** Enter the highest numbered port in the range
 - **To:** Enter the lowest numbered port in the range
- **Use Default Port Range:** Select this to use the port range that is defined in the daemon.
- **Maximum number of server processes:** Enter the maximum number of server processes that can run at the same time.
- **Limit server reuse:** Select this to limit the number of servers that can be reused. If this is selected, the **Reuse limit** parameter is available.

If **Limit server reuse** is selected, in the field next to the check box, enter the maximum number of times a server can be reused. Select the maximum of clients accepted in a server process.

A one-client server can be reused after its (single) client has disconnected. Reuse of servers enhances startup performance because it avoids the need to repeat initialization.

This parameter is not available if the Limit server reuse parameter is not selected.

This parameter is not available if the server mode value is **singleClient**.

- **Limit Concurrent clients per server:** Select this to limit the number of clients that a server can accept for the current workspace process.

If this is not selected, the number of clients is unlimited.

If **Limit concurrent clients per server** is selected, in the field next to the check box, enter the maximum number of clients that a server process for the current workspace accepts. The default for this field is **None**, indicating that the number of clients for each server is unlimited. This field is available if the server mode value is **multiClient** or **multiThreaded**.

- **Specify Server Priority:** Enter the server priority. For example, a workspace for applications with online transaction processing can be assigned a higher priority than a workspace that requires only query processing. The lower the number, the higher the priority. For example, workspaces with a priority of 1 are given a higher priority than workspaces with a priority of 2.

Note: This is unavailable if **Use default server priority** is selected.

- **Use default server priority:** Select this to set the priority to 0. There is no specific priority for this workspace. Clear this check box to set a priority in the **Specify Server Priority** parameter.
- **Keep when daemon ends:** Select this to stop all servers started by that daemon when a daemon is shutdown, even if they are active. Select this if you want the servers for the workspace to remain active, even after the daemon has been shut down. If selected, it is the responsibility of the system operator or manager to ensure that the servers are eventually stopped. This must be done at the system level.
- **Number of prestarted servers in pool:** Enter the number of server processes that are prestarted for this workspace when the daemon starts. These are available for use by new client processes with minimal initialization time. Instead of starting a new server process each time one is requested by a client, the daemon immediately allocates (to the client) a server from a pool of available servers. When the number of available server processes drops lower than the value specified in the Minimum number of available servers field, the daemon again starts server processes until the specified number of available servers is reached. The default for this parameter is 0, meaning that no servers are prestarted for this workspace.
- **Number of spare servers:** Enter the minimum number of server processes in the prestarted server's pool before the Oracle Connect daemon resumes creating new server processes (up to the number specified in the Initial number of servers field value, described earlier). If this parameter is set to a value greater than the Initial number of servers field value, the daemon considers the value to be the same as the value specified in the Initial number of servers field. In this case, a new server process is started and added to the pool each time a server process is removed from the pool and allocated to a client). The default for this parameter is 0, which means that new servers are created only when there are no other available servers.
- **Number of sub-tasks:** Enter the number of sub-tasks for a server that are prestarted for this workspace when the daemon starts. In addition to setting up a

pool of server processes as described earlier, you can set additional server processes as sub-tasks by specifying this parameter. If you set 10 servers and 10 prestarted sub-tasks then 100 tasks are started (10 sub-tasks for each process).

7.2 Configuring a Binding Environment

Each binding configuration includes the following information:

- Environment settings, which are used to configure the environment used by any of the adapters defined in the binding.
- Application adapters on the current computer.

To configure environment settings in Oracle Studio, perform the following steps:

1. From the **Start** menu, select **Programs, Oracle**, and then select **Studio**.
2. In the Design perspective Configuration view, expand the **Machine** folder, then expand the machine where you want to configure the binding.
3. Expand the **Bindings** folder. The binding available on this computer are listed.
4. Right-click **NAV** and select **Open**.
5. In the **Environment** tab, edit the environment settings as needed. To edit an environment setting, expand the property category and click the value to edit.

The binding **Environment** tab is shown in the following figure:

Figure 7–2 The Binding Properties tab

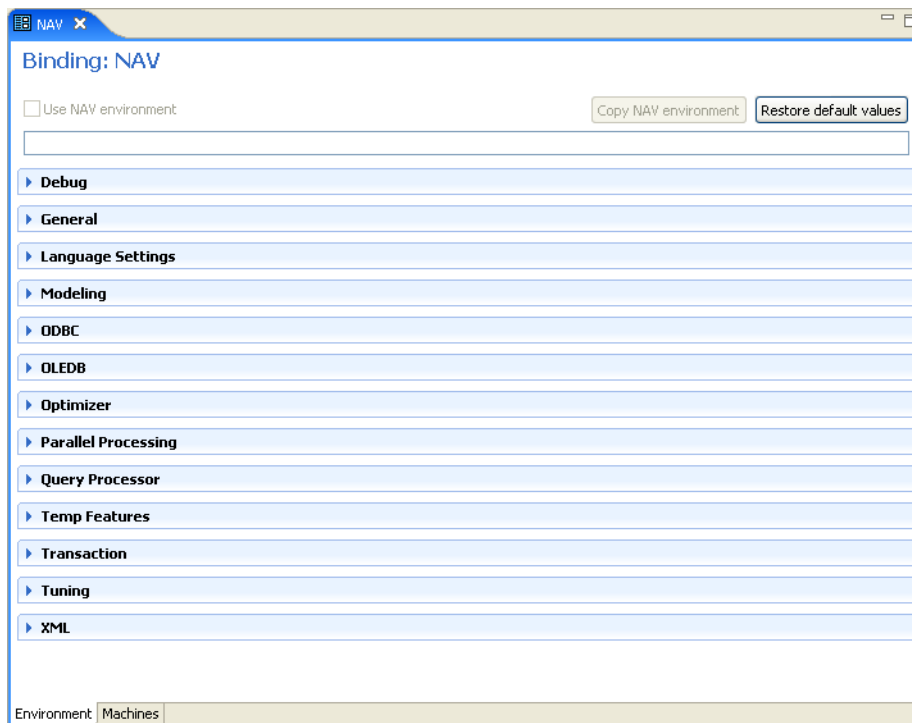

The binding environment is divided into the following categories:

- [Debug](#)
- [General](#)

- Language
- Modeling
- ODBC
- OLEDB
- Optimizer
- Parallel Processing
- Query Processor
- Transactions
- Tuning
- XML

7.2.1 Debug

The following table lists the parameters that define debugging and logging operations:

Table 7–2 *Debug Parameters*

Parameter	Description
ACX trace	Select this for the input xml sent to the back-end adapter and the output xml returned by the back-end adapter to be written to the log.
GDB Trace	This parameter is not applicable for use with OracleAS CDC Adapter for VSAM.
General trace	Select this to log general trace information. The default writes only error messages to the log. Note: Changing the default setting can degrade performance.
Query warnings	This parameter is not applicable for use with OracleAS CDC Adapter for VSAM.
Add timestamp to traced events	Select this to add a time stamp on each event row in the log.
Query processor trace	This parameter is not applicable for use with OracleAS CDC Adapter for VSAM.
Binary XML Log Level	Select the binary XML log level from the list. The following logging levels are available: <ul style="list-style-type: none"> ■ None ■ API ■ Info ■ Debug
Log file	The high-level qualifier of the log file for messages. The following type of messages are written to the log: <ul style="list-style-type: none"> ■ Error messages ■ Trace information and information about the query optimization strategy, if General Trace is selected.
Trace Directory	This parameter is not applicable for use with OracleAS CDC Adapter for VSAM.

Table 7–2 (Cont.) Debug Parameters

Parameter	Description
Optimizer trace	This parameter is not applicable for use with OracleAS CDC Adapter for VSAM.
Transaction extended logging	Select this for the transaction manager to write additional information about transactions to the log.

7.2.2 General

The following table lists the parameters that define general operations where temporary files are written.

Table 7–3 General Parameters

Parameter	Description
Nav Utility Editor	This parameter is not applicable for use with OracleAS Adapter for VSAM.
Temporary directory	The directory where temporary files are written, including the temporary files created for use by hash joins and for sorting files. The default is the current high-level qualifier.
Year 2000 policy	<p>Determines the way 2-digit years are converted into 4-digit years. When the parameter year2000Policy is not set, or when it is set to a value outside the range of values defined for the policy, as described in the following paragraphs, a default value of 5 and the Sliding Base Year policy is used. Two policies are provided:</p> <ul style="list-style-type: none"> ■ Fixed Base Year: year2000Policy is set to a value greater than, or equal to 1900. In this case, the value of year2000Policy is the first 4-digit year after 1900 that can be represented by a 2-digit year. For example, if year2000Policy is set to 1905, the years 2000->2004 are represented by 00->04. All other 2 digits are mapped to 19xx. ■ This solution is most required if there is live data at the low end (close to the year 1900), which the user wants to keep with the current 2-digit format. ■ The user probably changes the base date only after ensuring that these old dates have been deleted from the data source. ■ Sliding Base Year: year2000Policy is set to a positive value less than 100. In this case, the value of year2000Policy represents the number of years ahead of the current year that can be represented by a 2-digit number. With each passing year the earliest year that can be represented by a 2-digit number changes to a year later.
Cache buffer size	Enter the number of bytes to be used for a memory buffer on a client computer, which is used by the Oracle Connect client/server to store read-ahead data. The default is 200000.

7.2.3 Language

The following table lists the parameters that define globalization support:

Table 7–4 Language Parameters

Parameter	Description
Language	Identifies the application language. A default code page is selected based on the value specified for this parameter. For more information, see Appendix E, "Globalization Settings" .
Code Page	For use with globalization support to identify the code page for the workspace. For more information, see Appendix E, "Globalization Settings" .
NLS String	Specifies the code page used by a field whose data type is defined as <code>nlsString</code> . Use this for a field whose code page is other than that of the computer code page. This parameter includes the following values: <ul style="list-style-type: none"> ■ The name of the code page. ■ Whether the character set reads from right to left (as in middle eastern character sets). <p>The default is <code>false</code>.</p>

7.2.4 Modeling

The modeling parameters are not applicable with OracleAS CDC Adapter for VSAM.

7.2.5 ODBC

The odbc parameters are not applicable for use with OracleAS CDC Adapter for VSAM.

7.2.6 OLEDB

The oledb parameters are not applicable for use with OracleAS CDC Adapter for VSAM.

7.2.7 Optimizer

The following parameters enable you to customize the performance:

Optimizer goal: The optimization policy. Select one of the following from the list to the right:

- **none** (default): All row optimization is used.
- **first:** First row optimization is performed based on the assumption that the results produced by the query are used as the rows are retrieved. The query optimizer uses a strategy that retrieves the first rows as fast as possible, which might result in a slower overall time to retrieve all the rows.
- **all:** Optimization is performed based on the assumption that the results produced by the query are used after all the rows have been retrieved. The query optimizer uses a strategy that retrieves all the rows as fast as possible, which might result in a slower time to retrieve the first few rows.

Aggregate queries automatically use all row optimization, regardless of the value of this parameter.

All other optimizer parameters are not applicable for use with the OracleAS CDC Adapter for VSAM.

7.2.8 Parallel Processing

The following list shows the parallel processing properties. The parallel processing properties control how parallel processes are handled in the binding.

Table 7–5 Parallel Processing Parameters

Parameter	Description
Disable threads	Select this to disable multi-threading. If this is selected, the following properties are disabled: <ul style="list-style-type: none"> ▪ Disable threaded read ahead (QP): Select this to disable read-ahead functionality. ▪ Disable query read ahead (QP): Select this to disable read-ahead functionality for components using Query Processor services. ▪ ODBC async execution Select this property to enable ODBC asynchronous execution ▪ Disable QP parallel execution: Select this to disable parallel processing for query execution. This option is available only if both Disable threaded read ahead (QP) and Disable query ready ahead (QP) are <i>not</i> selected. ▪ Hash parallelism: Select this to read both sides of hash joins at the same time. By default, this property is selected. If you do not want this behavior, clear the check box.

7.2.9 Query Processor

The following table lists the parameters that enable you to fine tune how queries are processed:

Table 7–6 Query Processor Parameters

Parameter	Description
Disable command reuse	Select this to disable Query Processor caching the executed state of a query for reuse.
Disable DS property cache	Select this to disable caching data source properties.
Disable insert parameterization	Select this to disable parameterization constants in INSERT statements.
Disable metadata caching	Select this to disable caching object metadata. If this is selected, the object metadata is taken from the original data source instead of the cache.
Disable query parameterization	Select this to not convert constants into parameters when accessing data sources.
Disable row mark field fetch	Select this for OLE DB <code>getRows</code> errors to be marked and reshown on every <code>getRows</code> , if the rowset is active.
Compile after load	Select this to compile an Oracle Connect procedure or view after it is read.

Table 7-6 (Cont.) Query Processor Parameters

Parameter	Description
Ignore segments bind failure	This property determines how Oracle Connect responds when the execution of a segment of a segmented data source fails: <ul style="list-style-type: none"> ■ Select this to Log a message and continue execution. This is the default setting. ■ Clear the check box to Log a message and stop execution. By default, this property is selected. If you want to stop execution after sending a message, clear this check box.
Prompt database-user password	Select this to configure Oracle Connect to prompt the user for security information when accessing a data source.
Use alternate qualifier	Select this to use the @ symbol instead of a colon (:) when connecting to multiple data sources.
Use table filter expression	Select this to enable the use of tables that have filter expressions specified in their metadata.
Write empty string as null	Select this to replace empty strings in a SET clause of an UPDATE statement or in a VALUES list of an INSERT statement with null values.
Optimistic for update	Select this to use optimistic locking as the default locking behavior on queries with a FOR UPDATE clause.
Disable compilation cache	Select this to disable saving successfully compiled statements in the cache.
Maximum SQL cache	Enter the maximum number of SQL queries that can be stored in cache memory. This property's value is ignored if Disable compilation cache is selected. The default is 3.
First tree extensions	Enter the maximum size allowed for an SQL query after compilation. The default is 150.
Maximum columns in parsing	Enter the maximum number of columns that a query can reference. The default is 500.
Maximum segmented database threads	Enter the maximum number of open threads allowed, when working with segmented databases.
Minimum number of parameters allocated	Enter the minimum number of parameters that can be used in a query.
Continuous query retry interval	Enter the number of seconds that the query processor waits before executing a query again, when no records are returned. The default is 2.
Continuous query timeout	Enter the number of seconds that the query processor continues to issue queries when no records are returned. The default is 3600 (one hour), which indicates that after an hour without new messages the continuous query ends. Enter 0 to indicate that there is no timeout and the continuous query does not end automatically.
Continuous query prefix	Enter a prefix to replace the \$\$ prefix that is used to identify the continuous query special columns. For example, if you enter ##, then the continuous query alias is '##StreamPosition' and the control command alias is '##ControlCommand'.

Table 7–6 (Cont.) Query Processor Parameters

Parameter	Description
Arithmetic fixed precision	<p>Enter an integer determine the precision scale factor for floating decimal position. The default is 0, which indicates that the exact arithmetic function is not used.</p> <p>When the value is set to a small positive integer, the special precise floating point arithmetic is used in the query processor. The value determines the precision scale factor (for example, a value of 2 indicates two digits decimal precision). Setting this parameter can be done at a workspace level and it affects all queries running in that workspace with no change to the query or to the underlying data source. The query processor ADD(), SUBTRACT() and SUM() functions that currently use double arithmetic for both floating and decimal types use this logic. When the value is set to the default, 0, the exact arithmetic function is not used.</p> <p>This property is used to set the Exact Arithmetic function. The <code>qpArithmeticFixedPrecision</code> property is an integer value that determines the fixed precision the Oracle Connect query processor uses for precise floating point arithmetic. It is used to create an accurate result when using the SUM function. Because floating point data types are not accurate their results over time does not correspond to the expected arithmetic sum. In other words, in the floating point representation, values such as 0.7 cannot be represented precisely. If there are eight precision digits, there is usually imprecision in the least significant digit so the number is actually approximately 0.699999995. The <code>qpArithmeticFixedPrecision</code> property corrects this imprecision by using an exact floating point.</p>
Parser depth	The maximum depth of the expression tree. The default is 500
Token size	Enter the maximum length of a string in an SQL query. The minimum value is 64. The default value is 350.
Insert from select commit rate	Enter the commit rate to use when executing an INSERT-FROM-SELECT operation. If a value more than 0 is entered, a commit is performed automatically after inserting the indicated number of rows. For example, if the value is 5, a commit is performed every time 5 rows are inserted.
Disable SQS cache	Select this to always read compiled Oracle Connect procedures and views from a disk. In this case, they are not saved in the cache.
Procedures cache size	Enter the number of stored queries created with a CREATE PROCEDURE statement that can be kept in cache memory. This property's value is ignored if Disable SQS cache size is selected.
Expose XML fields	<p>Expose XML fields: Select this to display data returned for a query as XML, representing the true structure of the result. This is useful when querying a data source table that contains arrays or variants.</p> <ul style="list-style-type: none"> XML field name: Enter the name used in a query to indicate that the data is returned as XML, instead of the keyword XML. This is available only if Expose XML fields is selected.

7.2.10 Transactions

The following table lists the parameters that define transaction support:

Table 7–7 Transaction Parameters

Parameter	Description
Transaction extended logging	Select this to write extended information about transactions to the transaction manager log files.
Commit on destroy	Select this to commit all single-phase commit transactions opened for a data source, if a connection closes while the transaction is still open.
Disable 2PC	Select this to disable two-phase commit capabilities, even in drivers that support two phase commit.
User commit confirm table	This parameter is not applicable for use with OracleAS CDC Adapter for VSAM.
Transaction log file	The high-level qualifier and name of the log file that logs activity when using transactions. The Transaction log file parameter can also include the keyword NORRS after a comma (so that the format is <code>log, NORRS</code>) when RRS is not running on the z/OS platform.
Recovery delay	The number of minutes from the start of a transaction before any recovery operation on that transaction can be attempted. The default is 15 minutes.
Time limit	Enter the time to wait for a transaction to complete before an error is returned. This parameter is also used when performing a RECOVERY, and it then indicates the number of minutes to wait before a forced activity can be performed, since the last transaction activity.
Conversions Select one:	<p>No conversion: Select this if you want all transactions to remain as sent. This is selected by default</p> <p>Convert all to distributed: Select this to convert all simple transactions into distributed transactions.</p> <p>Convert all to simple: Select this to convert all distributed transactions into simple transactions.</p>

7.2.11 Tuning

The following table lists the parameters that define the tuning:

Table 7–8 Tuning Parameters

Parameter	Description
Dsm maximum buffer size	Enter the maximum size of a cache memory. This cache is used when memory is required on a temporary basis (as when Oracle Connect sorts data for a query output, for a subquery, or for aggregate queries). This cache size is not used for hash joins and lookup joins. The default value is 1000000 bytes. For more information, see the <code>hashBufferSize</code> parameter.

Table 7–8 (Cont.) Tuning Parameters

Parameter	Description
Dsm maximum Sort buffer size	Enter the maximum size of the sort buffers. Use this parameter instead of <code>dsmMaxBufferSize</code> for sorts only. The default value is 1000000 bytes.
Dsm middle buffer size	Enter the maximum size of the index cache. This cache is not used for hash joins and lookup joins. The default value is 100000 bytes.
File pool size	Enter the maximum number of files that can be opened in the file pool. The default is 10.
File pool size per file	Enter the size of the file in the pool. The default is 3.
File close on transaction	Select this if you want the File Pool to close when a transaction is committed.
Use global file pool	Select this to use a global file pool. When the workspace server mode parameter is set to <code>multiClient</code> or <code>reusable</code> , this parameter also indicates whether the file pool closes upon the client disconnection.
Hash buffer size	Enter the amount of cache memory that is available for each hash join or lookup join. The default is 1000000 bytes.
Hash max open files	Enter the maximum number of files that a query can open simultaneously for use when performing hash joins. The number assigned to this parameter must not exceed the system maximum. The default is set to 90 files. Note: The hash join optimization strategy results in several files being opened to perform the join. The larger the table size, the more files are opened. By adjusting this parameter you can disable hash joins on very large tables, while allowing hash joins for small tables.
Hash primary extent size	Enter the primary extent size.
Hash secondary extent size	Enter the secondary extent size.
Hash enable RO	Select this for the QP to store the first hash bucket in memory instead of a sequential file.

7.2.12 XML

The following table lists the parameters that define XML support:

Table 7–9 XML Parameters

Parameter	Description
COM maximum XML in memory	Specifies the maximum size of an XML document held in memory. The default is 65535 bytes.
COM maximum XML size	Specifies the maximum size of an XML document passed to another computer. The default is 65535 bytes. Note: When you increase this value for this property, it may be necessary to increase the value for the Maximum XML in memory property in the daemon. For more information on daemons, see Control .
COM XML transport buffer size	Enter the maximum size of the internal communications buffer. The default value (-1) indicates there is no size limit.

Table 7–9 (Cont.) XML Parameters

Parameter	Description
XML date format	Enter the date format to use for XML. The options are: <ul style="list-style-type: none"> ■ ISO (the default): The date format is: YY-MM-DDThh:mm:ss [.ss. .] ■ ODBC: The date format is: YYYY-MM-DD HH:MM:SS [.NNN. . .]
Replace invalid XML characters	Select this to replace invalid XML characters with a '?'. This property is used for diagnostic and troubleshooting purposes.
XML trim char columns	Select this to enable padded spaces to be trimmed from XML string columns when the record format is fixed. By default this is selected, and padded spaces are trimmed for fixed size character columns. If you do not want this behavior, clear this check box.

7.3 Migration Considerations

You can migrate an adapter configuration from one platform to another. The configuration information is stored in the Oracle Connect repository on the source platform and is exported to an XML file which can then be imported to the target platform.

Note that when migrating a configuration, file names and paths that are specific to the source platform must be changed to valid files on the target platform.

To migrate an adapter configuration using Oracle Studio, perform the following steps:

1. From the **Start** menu, select **Programs, Oracle**, and then select **Studio**.
2. In the Design perspective, Configuration view, expand the **Machines** folder.
3. Right-click the required computer, and select **Export XML definitions**.
4. In the **File name** field, type the path and name of the XML file where the XML representation of the computer and its complete configuration is stored.
5. Edit any paths in the XML definition to the paths required on the target platform. For example, the setting for the serverLogFile parameter may require changing, depending on the platform.
6. Set up the target platform in Oracle Studio in the same way you set up the source platform, as described in [Setting Up the IBM z/OS Platform in Oracle Studio](#).
7. In the Configuration Explorer, right-click the target computer and select **Import XML definitions**.
8. Import the XML file to the target platform.

7.4 Security Considerations

Oracle Connect works within the confines of the platform security system. For example, on an z/OS computer with RACF installed, and with the workspace server mode set to multi-tasking, a RACROUTE VERIFY is performed for each task in the address space, according to the client connection.

In addition, Oracle Connect provides the following security:

- A binary XML encryption mechanism, which is activated as follows:
 1. The client's first message to the server includes a pre-defined shared key, including the key name and value in the connection string. The server gets the

key value for the key name passed from the client from the native object store (NOS).

2. The server generates a random 128-bit RC4 session key which is returned encrypted to the client, using the shared key. If no predefined shared key is provided, then a predefined, hardcoded key is used (this key is hardcoded on the client and on the server).
 3. Passwords are always encrypted when passed over the wire, using an RC4, 128-bit session key, regardless of whether the entire session is encrypted or not.
 4. If a predefined shared key was provided, then the entire session is encrypted. Otherwise, only the password exchange is encrypted (using the hardcoded key).
- **Credentials:** Passwords and user names exchanged over the network are encrypted using a pre-defined, hardcoded, 128-bit RC4 session key.
 - **Design Time:** Security within Oracle Studio to grant access to Oracle Studio itself and to grant access to computers, user profiles and workspaces.
 - **Run time:** Security used to access VSAM, including controlling the daemon for the access.

7.4.1 Setting Design Time Security

Set the design time security as described in the following sections:

- Securing access to Oracle Studio is described in [Setting Password Access to Oracle Studio](#).
- Securing rights to configure a computer in Oracle Studio is described in [Specifying Users with Administrative Rights](#).
- Securing access to user profiles is accomplished by right-clicking the relevant user profile in Oracle Studio and selecting Change Master Password. In the dialog box that is displayed, specify a password that must be provided in the future to edit the specific user profile.
- Securing access to workspaces is accomplished by right-clicking the relevant workspace in Oracle Studio and selecting Set Authorization. In the dialog box that is displayed, specify a valid user and password that must be provided in the future to edit the specific workspace.

7.4.2 Setting Run Time Security

During run time, security considerations are implemented as follows:

- When the client request accesses the legacy platform through the daemon, either anonymous access is allowed or a valid user name and password must be provided for the computer in the user profile. The `userName` and `password` properties in the J2CA 1.5 VSAM adapter are used at this stage to access the daemon.

Note: The user name used to access the daemon must also be the name of a user profile used.

- Access by the client must be through a valid port, according to the port range entered in the **Server** section of the workspace **Server Mode** tab in Oracle Studio. For more information, see the explanation of the workspace [Server Mode](#).

Note: Access to the legacy platform through a firewall using the NAT protocol is specified when the computer is added to Oracle Studio.

- To be allocated a server process, the client must be granted anonymous access to the workspace or be listed in the **Authorized Workspace Users** section of the workspace **Security** tab in Oracle Studio. For more information, see the explanation of the workspace [Security](#) tab.
- The ability to run commands on the daemon, such as starting or stopping a daemon or ending server processes is available only to administrators who have been registered in Oracle Connect as a daemon administrator. A client is registered as a valid daemon administrator in the Administrator privileges section of the daemon **Security** tab in Oracle Studio. For more information, see explanation of the daemon [Security](#) tab.

Note: You can also specify administrators who can run commands only at the level of the workspace. Select these administrators in the workspace **Security** tab, as described in the explanation of the workspace [Security](#).

7.5 Transaction Support

OracleAS CDC Adapter for VSAM supports global transactions and can fully participate in a distributed transaction if you access the VSAM data under CICS.

Note: To use OracleAS CDC Adapter for VSAM with global transactions, you must have RRS installed and configured.

To work with global transactions, select **Convert all to distributed** in the Transaction section of the binding environmental properties. For more information, see [Transactions](#) in the [Configuring a Binding Environment](#) section.

To use global transactions capability to access data on the z/OS computer, define every library in the ATTSRVR JCL as an APF-authorized library.

To define a DSN as APF-authorized, in the SDSF screen, enter the following command:

```
"/setprog apf,add,dsn=instroot.library,volume=ac002"
```

Where ac002 is the volume where you installed Oracle Connect and *INSTROOT* is the high level qualifier where Oracle Connect is installed.

If the Oracle Connect installation volume is managed by SMS, when defining APF-authorization, then enter the following command in the SDSF screen:

```
"/setprog apf,add,dsn=instroot.library,SMS"
```

Ensure that the library is APF-authorized, even after an IPL (restart) of the computer.

If RRS is not running, then OracleAS Adapter for VSAM can participate in a distributed transaction, as the only one-phase commit resource, if you enter the keyword `NORRS`, as shown in the in the **Transaction log file** property. The Transaction log file property is in the [Transactions](#) section in [Configuring a Binding Environment](#).

Note: If a no log file is entered, then the format for the **Transaction log file** parameter when RRS is not running is:
`, NORRS`.

Advanced Tuning of the Metadata

Oracle Studio enables you to define outbound adapter interactions. In addition, Oracle Studio defines input and output structures used for these interactions. The interactions and input and output structures are maintained as metadata by Oracle Studio in the **Metadata** tab of the Design perspective.

This appendix contains the following sections:

- [Metadata for the VSAM Data Source](#)
- [Adapter Metadata](#)

A.1 Metadata for the VSAM Data Source

Using Oracle Studio, perform the following steps to maintain the metadata for the VSAM data source:

1. From the **Start** menu, select **Programs, Oracle**, and then select **Studio**.
2. Expand the **Machines** folder, then expand the machine with the metadata you are working with.
3. Expand the **Bindings** folder.
4. Expand the **NAV** binding.
5. Expand the **Data sources** folder to display the data sources.
6. Right-click the VSAM data source and select **Show Metadata View** to display the **Metadata** view.
7. Right-click the table you want to view in the Metadata Explorer and select **Edit**.

The metadata editor opens, displaying the **General** tab, with general table details. The following tabs are used to view and edit the metadata:

- [General Tab](#)
- [Columns Tab](#)
- [Indexes Tab](#)
- [Statistics Tab](#)
- [Advanced Tab](#)

A.1.1 General Tab

Use the **General** tab to maintain information about the whole table, such as the table name and the way the table is organized.

The **General** tab is shown in the following figure:

Figure A-1 The General Tab

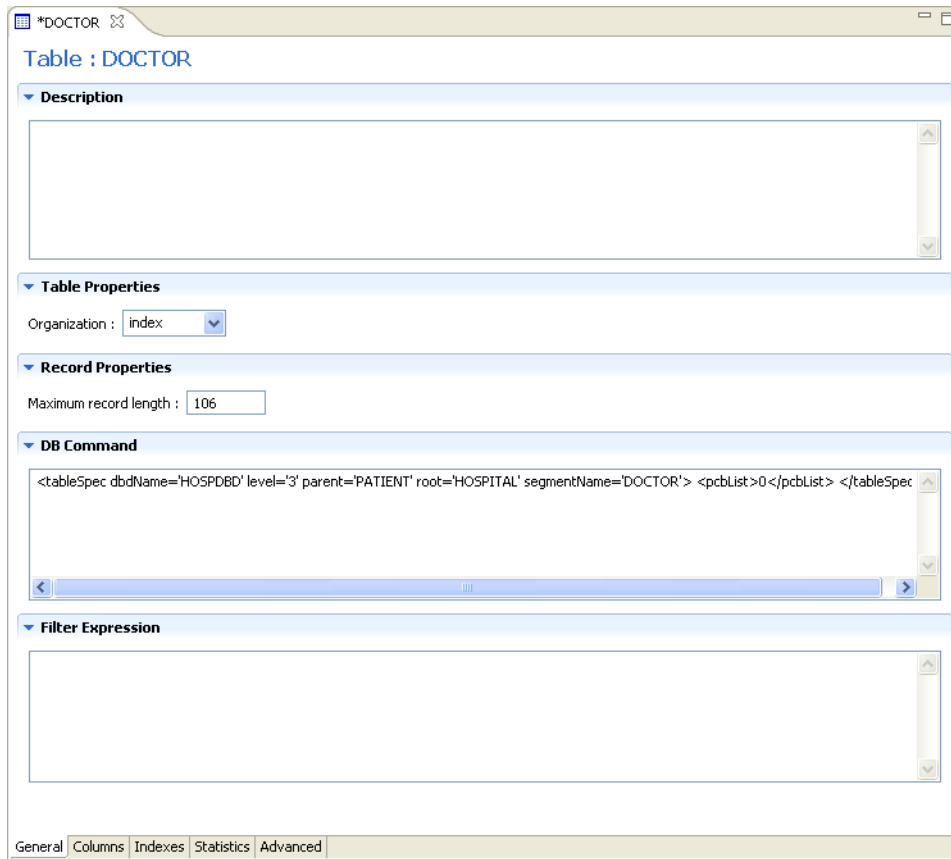

The **General** tab comprises fields, as listed in the following table:

Table A-1 General Tab Components

Field	Description
Description	An optional description of the table.
Table Properties	
Data file location	The name of the file that contains the table. You must enter the full path and include the file extension for the file. For example, <code>D:\COBOL\orders.cob</code> . You can click Browse and browse to find and enter the location of the table file. Note: Do not enter the file extension for DIASM or CIASM files.

Table A-1 (Cont.) General Tab Components

Field	Description
Organization	<p>Select how the record represented by the table is organized. The options that are displayed depend on the record. The following options are available:</p> <ul style="list-style-type: none"> ■ Index ■ Sequential ■ Relative: Used with RRDS files. Access to a specific record number of a relative file is performed by using a pseudo column to specify the record position. The hash symbol (#) is used to specify a pseudo column. For example: <pre>SELECT * FROM colleges WHERE # = 6</pre>
Record format	Specifies how the record, represented by the table, is formatted. The options that are displayed depend on the record. The VSAM records have a fixed format.
Maximum record length	The maximum allowable size of a record (in bytes).
DB Command	VSAM specific commands are displayed in the DB Command section of the General tab. The information displayed is generated automatically when the metadata is generated and should not be modified.
Filter Expression	A WHERE clause. This clause is added to every query accessed using this metadata. The filter is specified without the WHERE keyword. Specify a filter when multiple logical tables are stored in the same physical file.

A.1.2 Columns Tab

Use the **Columns** tab to specify metadata that describe the table columns. The tab is divided into the following:

- [Column Definition Section](#)
- [Column Properties](#)

The **Columns** tab is shown in the following figure:

Figure A-2 The Columns Tab

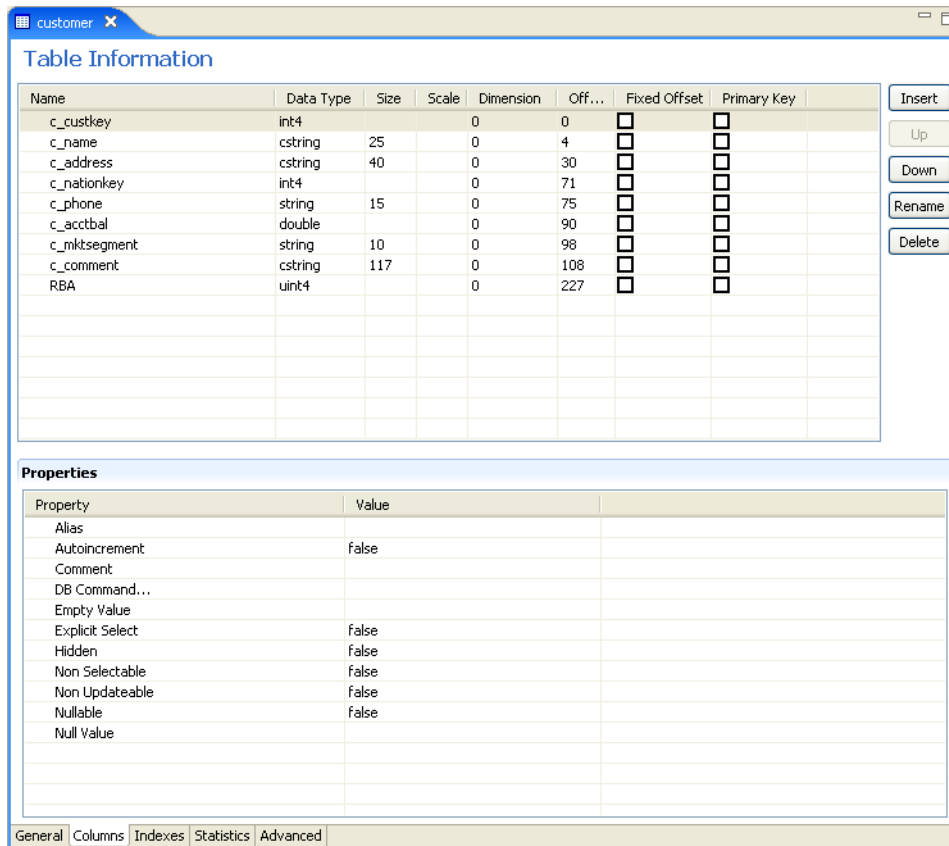

A.1.2.1 Column Definition Section

The top section of this tab lets you define the columns in the source data. You can click in any row (which represents a column in the data base table) to edit the information. The following table describes this section.

Table A-2 Metadata Column Tab Definitions

Field name	Description
Name	The name of the column
Data type	The data type of the column. Selecting this field displays a list of the possible data types.
Size	The size of the column
Scale	The information entered in this field depends on the data type: For decimal data types, this is the number of digits to the right of the decimal place. This number must not be greater than the number of digits. The default value is 0. For scaled data types, this is the total number of digits. The number must be negative.

Table A–2 (Cont.) Metadata Column Tab Definitions

Field name	Description
Dimension	<p>The maximum number of occurrences of a group of columns that are part of an array.</p> <p>The (+) to the left of a column indicates a group field. This type of field has a Dimension value. Click (+) to display the group members.</p>
Offset	An absolute offset for the field in a record.
Fixed offset	<p>This column lets you determine whether to calculate the offset. There are two options:</p> <ul style="list-style-type: none"> ■ Calc offset: If you clear this check box, the absolute offset for each of the columns is calculated. ■ Fixed offset: When you select this check box, you have a fixed offset. <p>The offset of a field is usually calculated dynamically by the server at run time according the offset and size of the proceeding column. Select the check box in this column to override this calculation and specify a fixed offset at design time. This can happen if there is a part of the buffer to skip.</p> <p>By selecting the check box, or by editing the offset value you pin the offset for that column. The indicated value is used at run time for the column instead of a calculated value. Note that the offset of following columns that do not have a fixed offset are calculated from this fixed position.</p>
Primary Key	Select this to indicate that this column is a primary key.

The buttons on the right side of the tab are used to manipulate the data in this section of the tab. The following table describes how you can move around in this section.

Table A–3 Definition Section Buttons

Button	Description
Insert	Inserts a column to the table. You can insert a new column. If the table has arrays, you can add a new child column.
Up	Moves your selection to the column directly above where the currently selected column.
Down	Moves your selection to the column directly below where the currently selected column
Rename	Lets you rename the selected column.
Delete	Deletes the selected column.
Find	Click this button to open a list of all columns in the database. Select a column and click OK to select it in the table.

A.1.2.2 Column Properties

You can change the property value by clicking in the **Value** column. To display the column properties, select a column from the Column Definition (top) section.

The properties for the column are displayed at the bottom of the tab.

The following table shows some properties available for selected columns.

Table A-4 Metadata Properties

Property	Description
Alias	A name used to replace the default virtual table name for an array. Virtual table names are created by adding the array name to the record name. When an array includes another array the name of the nested array is the name of the record and the parent array and the nested array. When the default generated virtual table name is too long, use an Alias to replace the long name.
Autoincrement	The current field is updated automatically by the data source during an INSERT statement and is not explicitly defined in the INSERT statement. The INSERT statement should include an explicit list of values. This attribute is used for fields such as an order number field whose value is incremental each time a new order is entered to the data source.
Comment	A short note or description about the column.
DB command	VSAM specific commands for the column The information displayed is generated automatically when the metadata is generated and should not be modified
Empty value	The value for the field in an insert operation, when a value is not specified.
Explicit Select	When true, the current field is not returned when you execute a SELECT * FROM . . . statement. To return this field, you must explicitly ask for it in a query, for example, SELECT NATION_ID, SYSKEY FROM NATION where SYSKEY is a field defined with Explicit Select. You cannot use an asterisk (*) in a query where you want to retrieve a field defined with the Explicit Select value.
Hidden	The current field is hidden from users. The field is not displayed when a DESCRIBE statement is executed on the table.
Non Selectable	When true, the current field is never returned when you execute an SQL statement. The field is displayed when a DESCRIBE statement is executed on the table.
Non Updateable	If true, the current field cannot be updated.
Nullable	This value allows the current field to contain NULL values.
Null value	The null value for the field during an insert operation, when a value is not specified.
Chapter of	This property shows that the set member field is a chapter of an owner field. A value for this property must be used when accessing a set member as a chapter in an ADO application. This property is used for DBMS metadata
OnBit	The position of the bit in a BIT field and the starting bit in a BITS field.
Subfield of	The value is generated automatically when you generate metadata from VSAM data that includes a superdescriptor based on a subfield. A field is created to base this index on, set to the offset specified as the value of the Subfield start field. If no value is entered in the Subfield start field, the subfield is set by default to an offset of 1.
Subfield start	The offset within the parent field where a subfield starts.

A.1.3 Indexes Tab

Use the **Indexes** tab to specify metadata describing the indexes of a table.

Note: The Indexes tab contains information only if the **Organization** field in the Table tab is set to **Index**.

The **Indexes** tab is shown in the following figure:

Figure A-3 The Indexes Tab

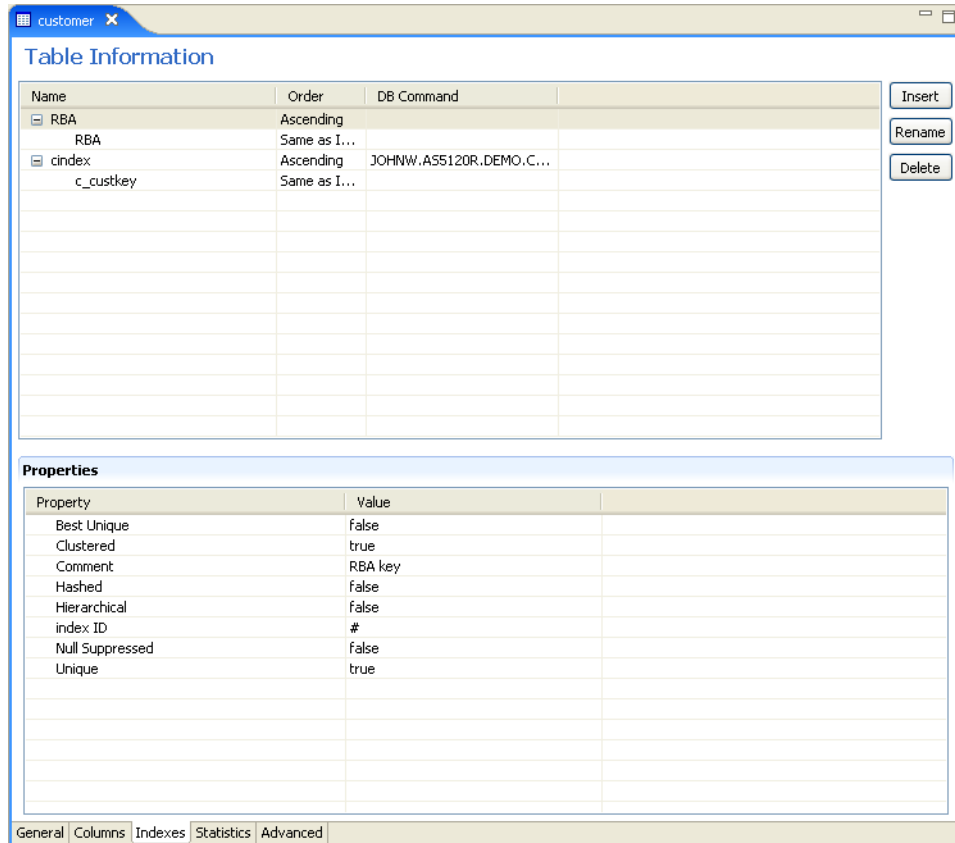

This tab has two sections. The first section lets you define the index keys for the columns in the table. The bottom of the tab lists the properties for each of the columns at the top.

The following sections describe the **Indexes** tab:

- [Table Information](#)
- [Properties](#)

A.1.3.1 Table Information

The following table describes the fields for the top part of the tab, which defines the indexes used for the table.

Table A-5 Indexes Tab Components

Field	Description
Name	The names of existing indexes for the current table.
Order	The ordering of the rows retrieved by the index.
DB Command	VSAM-specific commands for the index. The information displayed is generated automatically when the metadata is generated and should not be modified.

The buttons on the right side of the tab are used to manipulate the data in this section of the tab. The following table describes how you can move around in this section.

Table A-6 Index Definition Buttons

Button	Description
Insert	Inserts an index to the table.
Rename Index	Lets you rename the selected index.
Delete	Deletes the selected index.

A.1.3.2 Properties

You can index properties for each index column. To display the index properties, Select a column from the Index Definitions (top) section.

The properties for the column are displayed at the bottom of the tab.

This properties displayed at the bottom of the tab describe the index or segment. The properties available depend on the data source.

A.1.4 Statistics Tab

Use the **Statistics** tab to update metadata statistics for a table. The **Statistics** tab is shown in the following figure:

Figure A-4 The Statistics tab

The **Statistics** tab has three sections. The following tables describe each section.

Table A-7 Table Information

Field	Description
Rows	Enter or use arrows to select the approximate number of rows in the table. If the value is -1, then the number of rows in the table is unknown (a value was not supplied and the update statistics utility was not run to update the value). A value of 0 indicates that this table is empty.
Blocks	Enter or use arrows to select the approximate number of blocks in the table. Note: If neither the number of rows nor the number of blocks is specified for a table, queries over the table might be executed in a nonoptimal manner.

Use the Columns group box to specify cardinality for each of the columns in the table:

Table A-8 Columns group Components

Field	Description
Column name	The columns in the table.
Cardinality	The number of distinct values for the column. If the value is -1, then the number of distinct values for the column is unknown (a value was not supplied and the update statistics utility was not run to update the value). A value of 0 indicates that there are no distinct values for the column.

Use the Indexes group box to specify cardinality for the columns in each of the indexes in the table:

Table A-9 Indexes group Components

Field	Description
Indexes and segments	The indexes and segments in the table.
Cardinality	The number of distinct key values in the index. If the value is -1, then the number of distinct key values in the index is unknown (a value was not supplied and the update statistics utility was not run to update the value). A value of 0 indicates that there are no distinct key values in the index.

A.1.4.1 Generating Statistics

Click **Update** in the **Statistics** tab to generate updated statistics for the table. The Update Statistics screen is displayed, as shown in the following figure:

Figure A-5 The Update Statistics screen

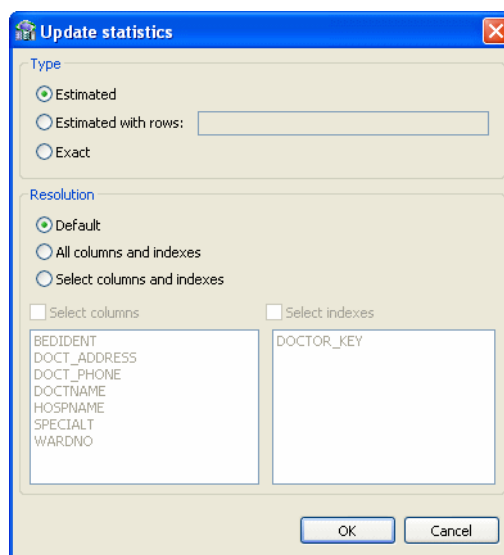

The following tables list the fields that are used to update statistics:

The **Type** section lets you edit the following:

Table A-10 Type Components

Field	Description
Estimated	An estimation of the amount of statistical information returned.
Estimated with rows	An estimation of the amount of statistical information returned. The estimate includes an estimation of the number of rows in the table. Specify the number in the text box. This number is used to shorten the time to produce the statistics if the value specified here is the correct value or close to the correct value.
Exact	The exact statistical information returned. Note that this can be a lengthy task and can lead to disk space problems with large tables.

The **Resolution** section lets you specify the statistical information returned:

Table A-11 Resolution Components

Field	Description
Default	Only information about the table and indexes is collected. Information for partial indexes and columns is not collected.
All columns and indexes	Information about the table, indexes, partial indexes and columns is collected.
Select columns and indexes	Enables you to select the columns and indexes for which you want to collect statistics. In the enabled list of columns or indexes, left click those columns you want included (you can use shift-click and control-click to select multiple columns or indexes).

A.1.5 Advanced Tab

The **Advanced** tab lets you enter information about the virtual view policy for arrays. These parameters are valid only if you are using virtual array views. You configure virtual array views in the [Modeling](#) section when [Configuring a Binding Environment](#).

The configurations made in this editor are for the selected table, only. The same parameters are configured on the data source level in the data source editor.

Figure A–6 Data Source Metadata Advanced Tab

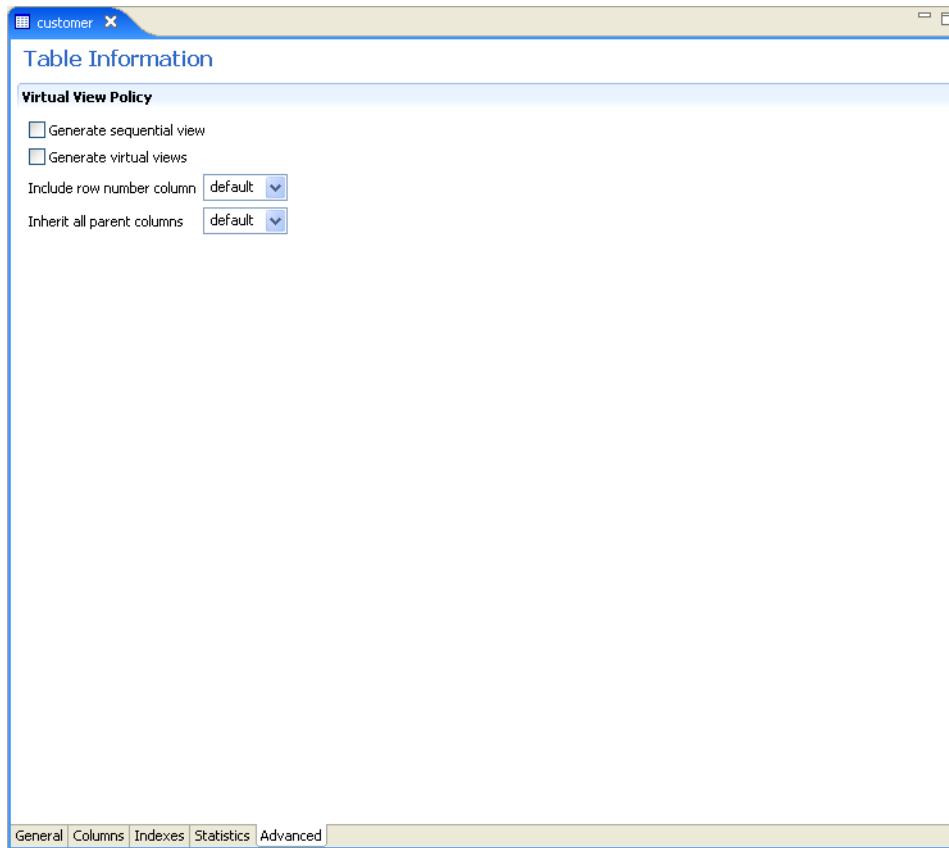

Enter the following information in this tab:

- **Generate sequential view:** Select this to map non-relational files to a single table.
- **Generate virtual views:** Select this to have individual tables created for each array in the non-relational file.
- **Include row number column:** Select one of the following:
 - **true:** Select **true**, to include a column that specifies the row number in the virtual or sequential view. This is true for this table only, even in the data source is not configured to include the row number column.
 - **false:** Select **false**, to not include a column that specifies the row number in the virtual or sequential view for this table even if the data source is configured to include the row number column.
 - **default:** Select **default** to use the default data source behavior for this parameter.

For information on how to configure these parameters for the data source, see [Configuring the Data Source Driver Advanced Properties](#).

- **Inherit all parent columns:** Select one of the following:

- **true**: Select **true**, for virtual views to include all the columns in the parent record. This is true for this table only, even in the data source is not configured to include all of the parent record columns.
- **false**: Select **false**, so virtual views do not include the columns in the parent record for this table even if the data source is configured to include all of the parent record columns.
- **default**: Select **default** to use the default data source behavior for this parameter.

For information on how to configure these parameters for the data source, see [Configuring the Data Source Driver Advanced Properties](#).

A.2 Adapter Metadata

Use Oracle Studio to maintain the metadata for the CDC Queue adapter in your staging area.

1. From the **Start** menu, select **Programs, Oracle**, and then select **Studio**.
2. Expand the **Machines** folder, then expand the machine with your staging area.
3. Expand the **Bindings** folder.
4. Expand the binding for your CDC staging area (with the `_sa` suffix).
5. Expand the **Adapters** folder to display the adapters list.
6. Right-click the CDC Queue adapter for your solution, and select **Show Metadata View** to open the Metadata view.

You can create and edit the following adapter metadata properties:

- **Adapter Metadata General Properties**: Enter and edit information about the adapter, such as the adapter name and the way in which you connect to the adapter. You make these changes in the Design perspective, Metadata view.
- **Adapter Metadata Interactions**: Enter details of an interaction. The interaction Advanced tab is displayed for some adapters only, such as the Database adapter and includes more details about the interaction.
- **Adapter Metadata Schema Records**: The input and output record structure for a record in the adapter definition.

A.2.1 Adapter Metadata General Properties

You can enter and edit information about the adapter, such as the adapter name and the way in which you connect to the adapter. You make these changes in the Design perspective, Metadata view. The following describes how to open the Adapter General Properties editor.

1. In Oracle Studio Design perspective, Metadata view, expand the **Adapters** folder.
2. Right-click the adapter to edit, and select **Open**.

The General properties editor is displayed.

The Adapter General Properties editor is shown in the following figure:

Figure A-7 Adapter Metadata General Properties

The screenshot shows a web-based configuration interface for an adapter named 'imstm'. It is divided into two main sections: 'Details' and 'Adapter Specifications'. The 'Details' section contains three text input fields: 'Description', 'Version' (which has '1.0' entered), and 'Header'. The 'Adapter Specifications' section contains a table with two columns: 'Property' and 'Value'. The table is currently empty.

The **General** properties are listed in the following table:

Table A-12 General tab Components

Field	Description
Description	Specifies an identifying description of the adapter.
Authentication mechanism	Specifies the authentication to access the adapter. The available mechanisms are: <ul style="list-style-type: none"> ■ kerbv5 ■ none ■ basic password
Max request size	Specifies the maximum size in bytes for an XML request or reply. Larger messages are rejected with an error.
Max active connections	Specifies the maximum number of simultaneous connections for an adapter (per process).
Max idle timeout	Specifies the maximum time, in seconds, that an active connection can stay idle. After that time, the connection is closed.
Adapter Specifications	Specifies the adapter-specific properties for an interaction. The CDC Queue adapter does not have any adapter-specific properties.

A.2.2 Adapter Metadata Interactions

The Adapter Metadata Interactions editor defines an interaction and its input and output definitions. The following describes how to open the Adapter Metadata editor.

1. In Oracle Studio Design perspective, Metadata view, expand the **Adapters** folder.
2. Expand the adapter with the interaction to edit.
3. Expand the **Adapter** folder.
4. Right-click the adapter you want to edit and select **Open**.

The Adapter Metadata Interactions editor is displayed.

The Adapter Metadata Interactions editor is shown in the following figure:

Figure A–8 Adapter Metadata Interactions

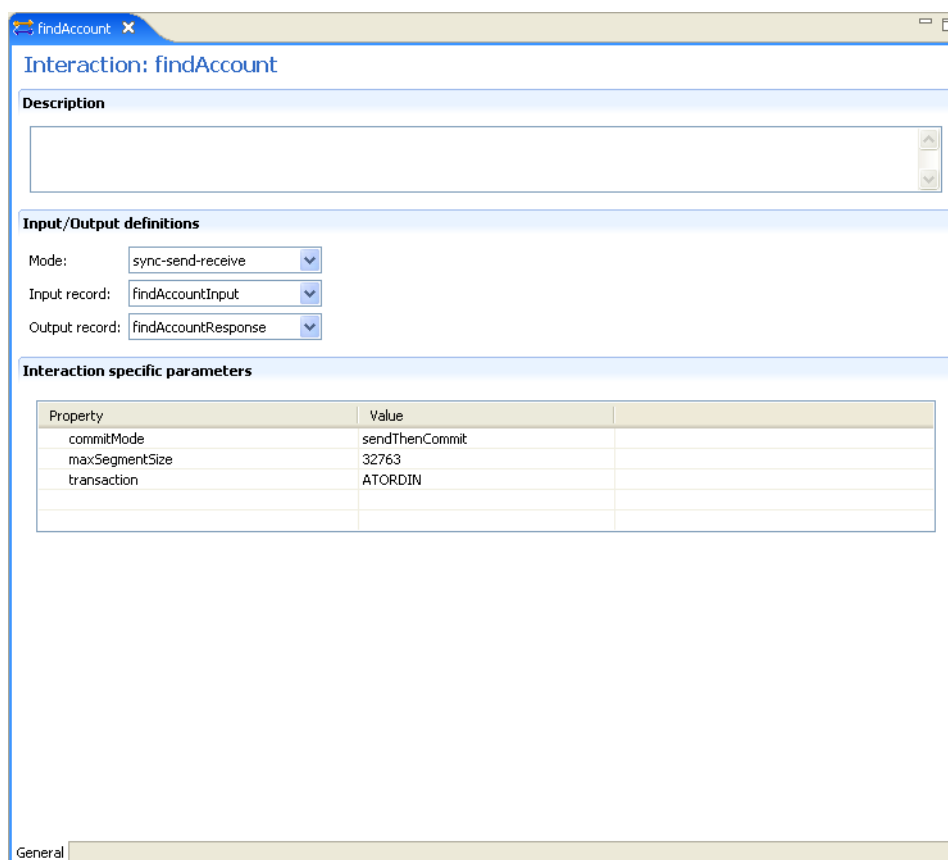

The Adapter Metadata Interaction properties are listed in the following table:

Table A–13 Interaction General tab Components

Field	Description
Description	Provides a descriptive identifier for the interaction.

Table A–13 (Cont.) Interaction General tab Components

Field	Description
Mode	Determines the interaction mode. The following interaction modes are available: <ul style="list-style-type: none"> ■ sync-send-receive: The interaction sends a request and expects to receive a response. ■ sync-send: The interaction sends a request and does not expect to receive a response. ■ sync-receive: The interaction expects to receive a response.
Input record	Identifies an input record.
Output record	Identifies an output record for the results of an interaction.
Interaction Specific Parameters	Specific properties for the interaction. When an Interaction Advanced tab is used, this section is not displayed. The parameters shown are for a Legacy Plug Adapter.

A.2.2.1 Interaction Advanced Tab

In the Adapter Metadata Interactions editor, click **Advanced** at the bottom of the editor to open the Interaction **Advanced** tab. Use this to enter advanced details for the interaction or to create interaction manually.

The following figure shows the Interactions **Advanced** tab.

Figure A-9 Interaction Advanced Tab

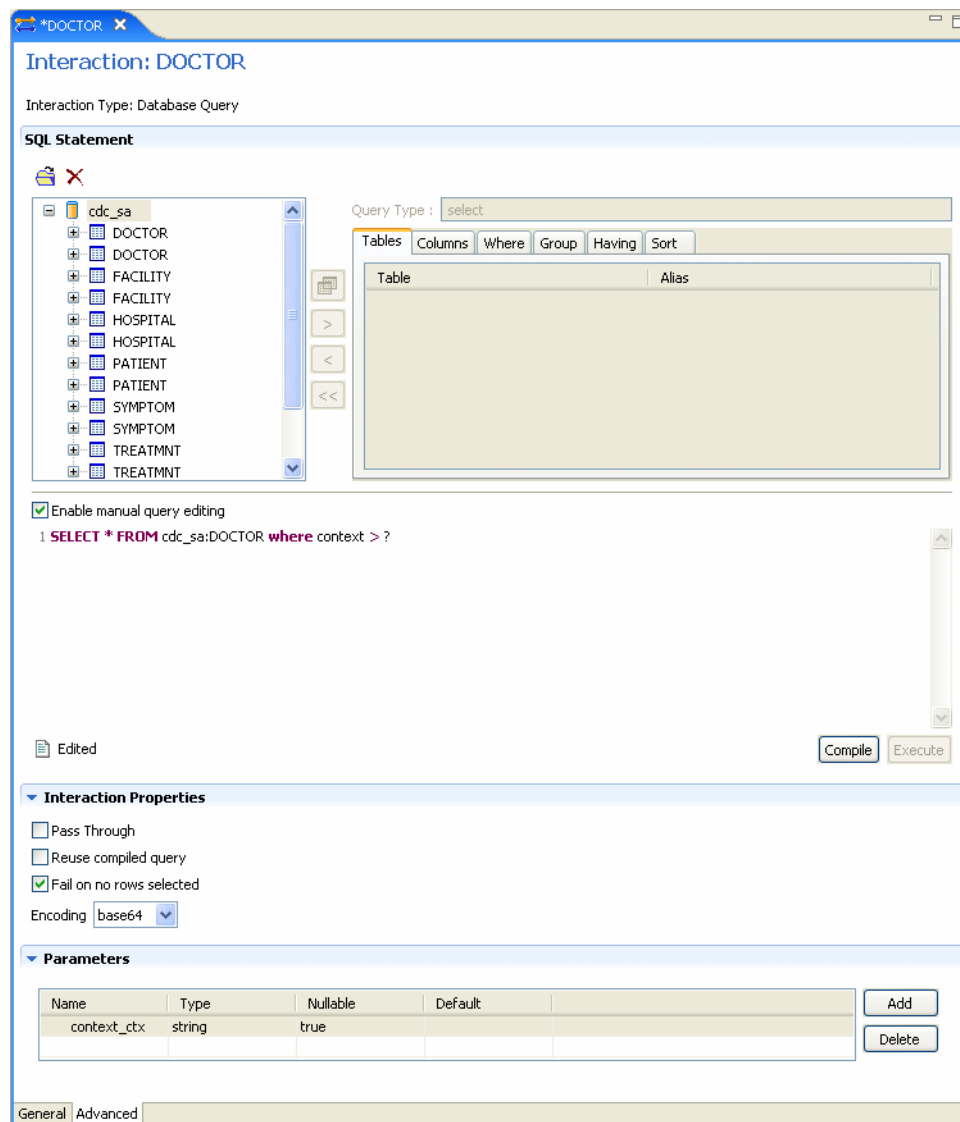

This tab has three sections.

The **SQL Statement** section lets you build any valid SQL statement. Use the tabs to select the tables and statement types and build a statement. When you select **Enable manual query editing**, you can manually enter a valid SQL statement at the bottom of the screen.

The **Interaction Properties** section lets you select any of the following:

- **Pass Through:** Select this to pass a query directly to the VSAM data.
- **Reuse compiled query:** Select this to save query objects created in the previous execution to the cache. This allows the objects to be reused.
- **Fail on no rows returned:** Select this if you want the system to return an error if no rows are selected.
- **Encoding:** Select one of the following from the list:
 - **base64:** Select this for base 64 encoding

- **hex**: Select this for hexadecimal encoding

The **Parameters** section lets you create parameters to use for the interaction. To create a parameter, click **Add**. Enter a name in the dialog box and click **OK**. The parameter is entered in the list. You can edit the following properties for each parameter you create. Click in the corresponding cell to edit the properties.

- **Name**: The name of the parameter. This is automatically entered when you create a new parameter. You can click in the cell to change this parameter.
- **Type**: The type of parameter. Select one of the following types from the list:
 - **string**
 - **number**
 - **timestamp**
 - **binary**
 - **xml**
- **Nullable**: Select True or False to determine whether the parameter can be nullable.
- **Default**: Enter a default value for the parameter, which is used if the parameter attribute is missing in the input record.

Notes:

- If a field is not nullable and a default value is not supplied in the schema part of the Adapter Definition, an error occurs if the parameter attribute is missing in the input record.
 - The parameters must be entered in the same order as they are used in the SQL statement.
-
-

A.2.3 Adapter Metadata Schema Records

The Adapter Metadata Schema Records editor defines the general details of the input and output record structures for the interaction. The following describes how to open the Adapter Metadata Schema Records editor:

1. In Oracle Studio Design perspective, Metadata view, expand the **Adapters** folder.
2. Expand the adapter with the schema records to edit.
3. Expand the **Schemas**.
4. Right-click the schema you want to edit and select **Open**.

The Adapter Metadata Schema Records editor is displayed.

The Adapter Metadata Schema Records editor is shown in the following figure:

Figure A–10 Adapter Metadata Schema Records

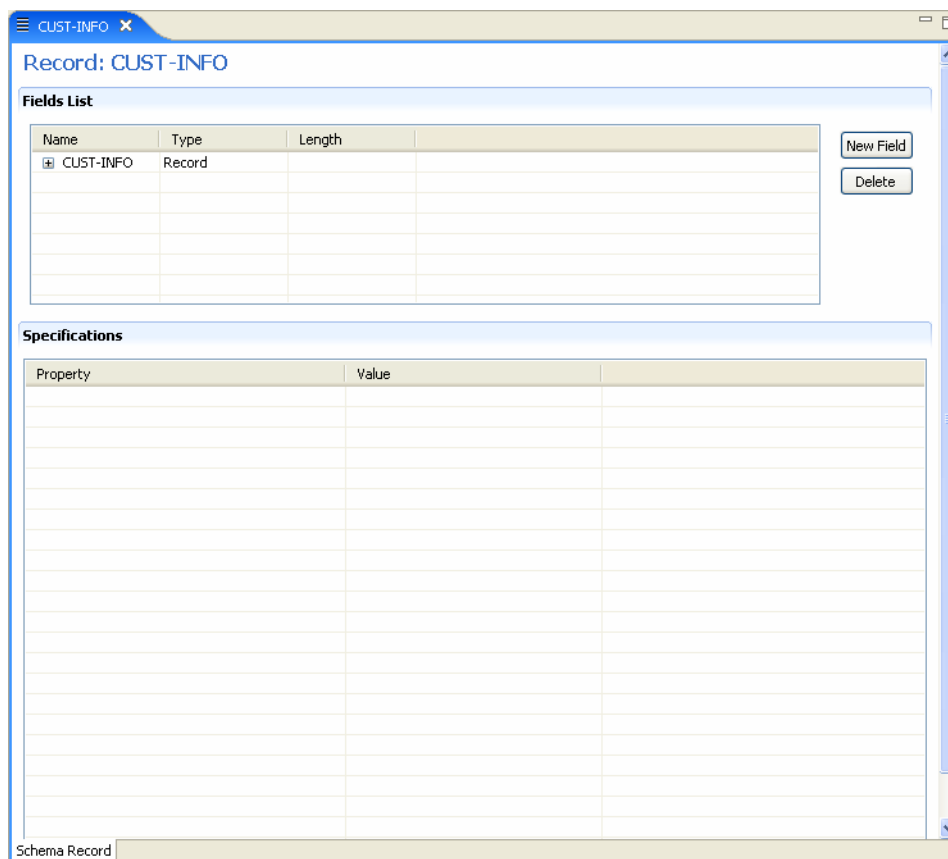

The Adapter Metadata Schema Records properties are listed in the following tables:

Table A–14 Schema Record Tab

Field	Description
Fields list	<p>Defines the single data item within a record. This section has a table with the following three columns:</p> <ul style="list-style-type: none"> ▪ Name: The name of the field ▪ Type: The data type of the field. For more information, see the Valid Data Types table for a list of the valid data types. ▪ Length: The size of the field including a null terminator, when the data type supports null termination (such as the string data type).
Specifications	<p>Defines specific field properties. To display the properties, select the specific field in the Fields list.</p>

The following table describes the valid data types that can be used when defining these specifications in the Schema Record editor.

Table A–15 Valid Data Types

Binary	Boolean	Byte
Date	Double	Enum

Table A–15 (Cont.) Valid Data Types

Binary	Boolean	Byte
Float	Int	Long
Numeric([p],[s])	Short	String
Time	Timestamp	

A.2.4 Adapter Metadata XML

You can also edit the adapter metadata by viewing its XML schema. The following describes how to open the adapter metadata XML editor:

1. In Oracle Studio Design perspective, Metadata view, expand the **Adapters** folder.
2. Right-click the adapter to edit, and select **Open as XML**.

The adapter XML editor is displayed in the Design view.

The adapter XML editor is shown in the following figure:

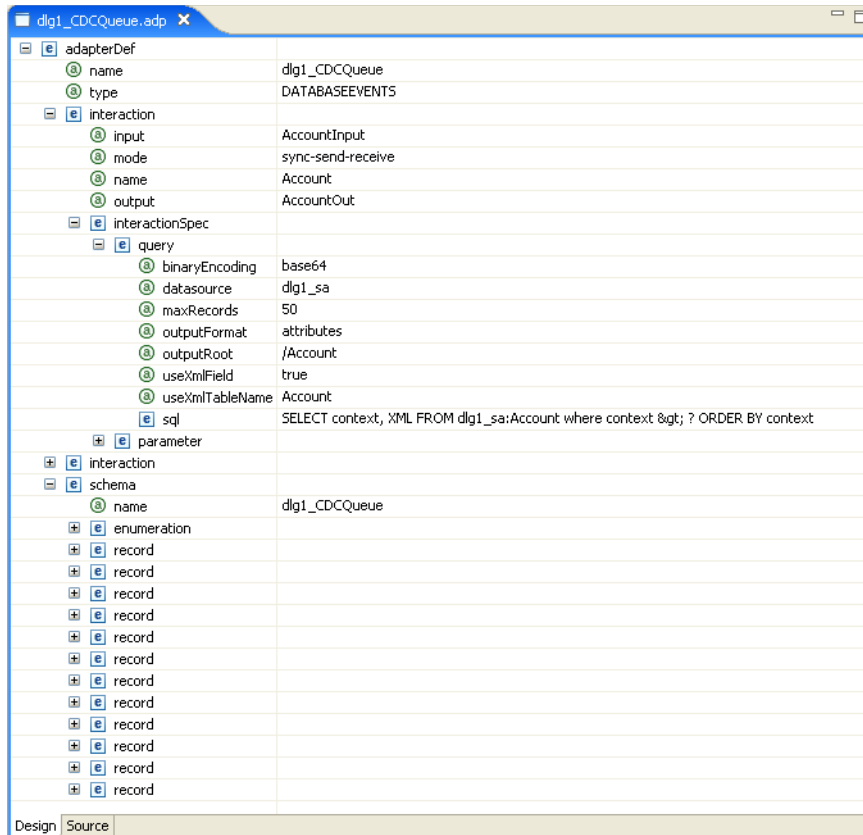
Figure A–11 Adapter Metadata XML Editor

For information on how to edit the properties in the XML editor Design view, see [Editing XML Files in Oracle Studio](#).

For an explanation of the attributes for the CDC Queue adapter that you should edit, see [CDC Queue Adapter Properties](#).

Advanced Tuning of the Daemon

The daemon configuration is managed using Oracle Studio. Daemon configuration is divided into the following groups:

- [Control](#)
- [Logging](#)
- [Security](#)
- [Workspaces](#)

B.1 Control

Using the **Control** tab for the daemon, you define various daemon control options. The **Daemon Control** tab is accessed as follows:

1. From the **Start** menu, select **Programs, Oracle**, and then select **Studio**.
2. From the Design perspective Configuration view expand the **Machines** folder.
3. Right-click the computer and select **Open Runtime Perspective**.
4. Right-click the required daemon in the Runtime Explorer and select **Edit Daemon Configuration**. The **Control** tab for the daemon is displayed in the editor.
5. After making changes to the daemon, right-click the daemon and select **Reload Configuration**.

Note: You can also change daemon settings using the Configuration Explorer, by selecting a computer and scrolling the list to the required daemon. Right-click the daemon and select **Edit Daemon**.

Changes made to the daemon configuration are only implemented after the configuration is reloaded using the **Reload Configuration** option in the Runtime Manager perspective.

The **Control** tab is shown in the following figure:

Figure B-1 The Control tab

Daemon: IRPCDINI

General

Daemon IP address:

If no address specified, the daemon will listen on all IP addresses available. If an address has been specified, the daemon will listen on that address.

Daemon port:

Port range for servers: From: To:

Automatically recover from failure

Maximum XML in memory:

Default language:

Maximum XML request size:

Timeout parameters

Call timeout:

Connect timeout:

Client idle timeout:

Control | Logging | Security

The following table shows the parameters that can be set in the **Control** tab:

Table B-1 Daemon Control tab Components

Field	Description
Daemon IP Address	Enter the IP address of the computer(s) where the daemon is listening. If no IP address is entered, the daemon listens on all available IP addresses.
Daemon port	Enter the port where the daemon is listening. If no port is entered, the daemon listens on all available ports.
Automatically recover from failure	The daemon restarts automatically if it fails for any reason (any error that causes the daemon process to terminate, such as network process lost or the CPU running the daemon crashes and the backup daemon is defined on another CPU). All available and unconnected servers are terminated and any connected servers are marked and terminated on release. Also the backup starts a backup for itself. The backup appends a new log file to the log of the original daemon, adding a line indicating that a backup daemon was started.
Maximum XML request size	The maximum number of bytes that the daemon handles for an XML document.
Default language	The language that the daemon supports. This setting is used when working with a client with a code page different from the server code page.
Maximum XML in memory	The maximum amount of space reserved for the XML in memory.

Table B-1 (Cont.) Daemon Control tab Components

Field	Description
Call timeout	<p>The timeout period for <i>short</i> calls for all daemons. The definition of a short call is a call that should be completed in a few seconds. For example, most calls to a database such as DESCRIBE should be completed in a few seconds as opposed to call like a GETROWS call, which can take a long time. In heavily loaded or otherwise slow systems, even short calls such as calls to open a file, may take a significant amount of time. If a short call takes more than the specified time to complete, then the connection is stopped. The default value for this parameter is 60 seconds. Values of less than 60 seconds are considered to be 60 seconds.</p> <p>Specifying the timeout in a workspace overrides the value set in this field for that workspace.</p>
Connect timeout	<p>The time the client waits for a daemon server to start. If the daemon server does not start within this period, then the client is notified that the server did not respond. The value specified for this parameter serves as the default timeout for all the workspaces listed in the daemon configuration. The default value for this parameter is 60 seconds.</p> <p>Notes:</p> <ul style="list-style-type: none"> ▪ Entering the timeout in a workspace overrides the value set in this field for that workspace. ▪ Even if the XML source does not list this parameter in the workspace section, the workspace gets it using the default value. To prevent a workspace from using the default value, you must enter a value of zero for this parameter in the workspace section.
Client idle timeout	<p>The maximum amount of time any daemon client may be idle before the connection with the server is closed.</p> <p>Specifying the timeout in a Workspace overrides this setting for that workspace.</p>

B.2 Logging

Using the **Logging** tab, you define the daemon log file settings, the log file structure and the location where the log is saved. In addition, use it to define the data that is logged and traced in the file.

The following describes how to open the **Logging** tab.

1. From the **Start** menu, select **Programs, Oracle**, and then select **Studio**.
2. From the Design perspective Configuration view expand the **Machines** folder.
3. Right-click a computer and select **Open Runtime Perspective**.
4. Right-click the daemon in the Runtime Explorer and select **Edit Daemon Configuration**.
5. Click the **Logging** tab.
6. After making changes to the daemon, right-click the daemon and select **Reload Configuration**.

Note: You can also change daemon settings using the Configuration Explorer, by selecting a computer and scrolling the list to the required daemon. Right-click the daemon and select **Edit Daemon**.

Changes made to the daemon configuration are only implemented after the configuration is reloaded using the **Reload Configuration** option in the Runtime Manager perspective.

7. Right-click the daemon and select **Recycle Servers**. Any servers in the connection pool are closed and new servers start with the new configuration.

The **Logging** tab for the daemon is shown in the following figure:

Figure B-2 The Logging tab

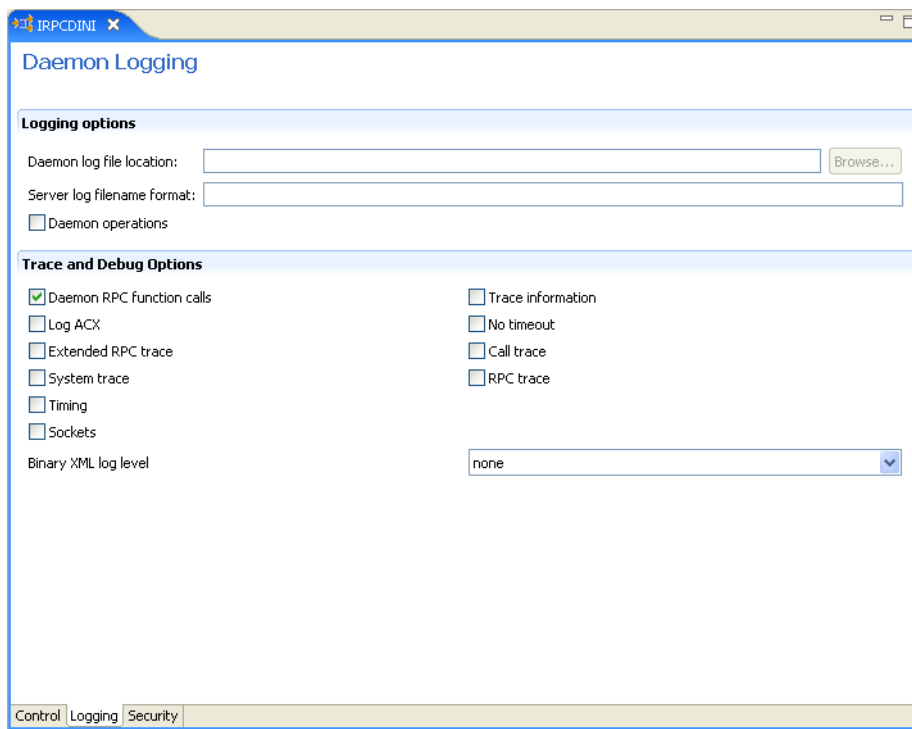

The **Daemon Logging** tab comprises fields, as listed in the following table:

Table B-2 Daemon Logging tab Components

Field	Description
Logging options	
Daemon log file location	Specifies the daemon produces its log data. The full path must be specified.
Server log filename format	Defines the name and location of the server log file. The field must specify the full path name. If no directory information is provided for the log file, then it is located in the login directory of the account running Oracle Connect workstation.
Daemon operations	Select this to log all of the daemon operations.

Table B-2 (Cont.) Daemon Logging tab Components

Field	Description
Tracing and debug options	
Daemon RPC function calls	Select this to log all daemon RPC function calls.
Log ACX	Select this if you want to log requests and processes.
Extended RPC trace	Generates a verbose message in the server log file for each low-level RPC function called. This is useful for troubleshooting the server.
System trace	Generates system-specific tracing of various operations.
Timing	Generates a time stamp for every entry to the server log file.
Sockets	Generates a message in the server log file for each socket operation.
Trace information	Select this to log low-level RPC operations.
No timeout	Disables the standard RPC timeouts, setting them to a long duration (approximately an hour) to facilitate debugging.
Call trace	Generates a message in the server log file for each RPC function called. This is useful for troubleshooting the server.
RPC trace	Enables debugging messages on the server.
Binary XML log level	Sets the binary XML log level. Your options are: <ul style="list-style-type: none"> ▪ debug ▪ none (the default) ▪ api ▪ info

The following tokens can appear in the log file template and are replaced accordingly:

- %A: workspace name
- %D: date (yymmdd)
- %I: instance number of the given workspace server
- %L: server account login directory
- %P: server process ID
- %T: time (hhmmss)
- %U: server account name (user name)

For example, %L/server_%A%I.log may produce a log file such as:
/usr/smith/server_sales15.log.

The default log file template is %L/server_%A%I.log.

B.3 Security

The following **Security** tab for the daemon is used to:

- Grant administration rights for the daemon.
- Determine access to the computer.

The following shows how to open the Daemon **Security** tab:

1. From the **Start** menu, select **Programs, Oracle**, and then select **Studio**.
2. From the Design perspective Configuration view expand the **Machines** folder.
3. Right-click the computer and select **Open Runtime Perspective**.
4. Right-click the daemon in the Runtime Explorer and select **Edit Daemon Configuration**.
5. Click the **Security** tab.
6. After making changes to the daemon, right-click the daemon and select **Reload Configuration**.

Note: You can also change daemon settings using the Configuration Explorer, by selecting a computer and scrolling the list to the required daemon. Right-click the daemon and select **Edit Daemon**.

Changes made to the daemon configuration are not implemented. They are only implemented after the configuration is reloaded using the **Reload Configuration** option in the Runtime Manager.

7. Right-click the daemon and select **Recycle servers**. Any servers in the connection pool are closed and new servers start with the new configuration.

The Daemon **Security** tab is shown in the following figure:

Figure B–3 The Daemon Security tab

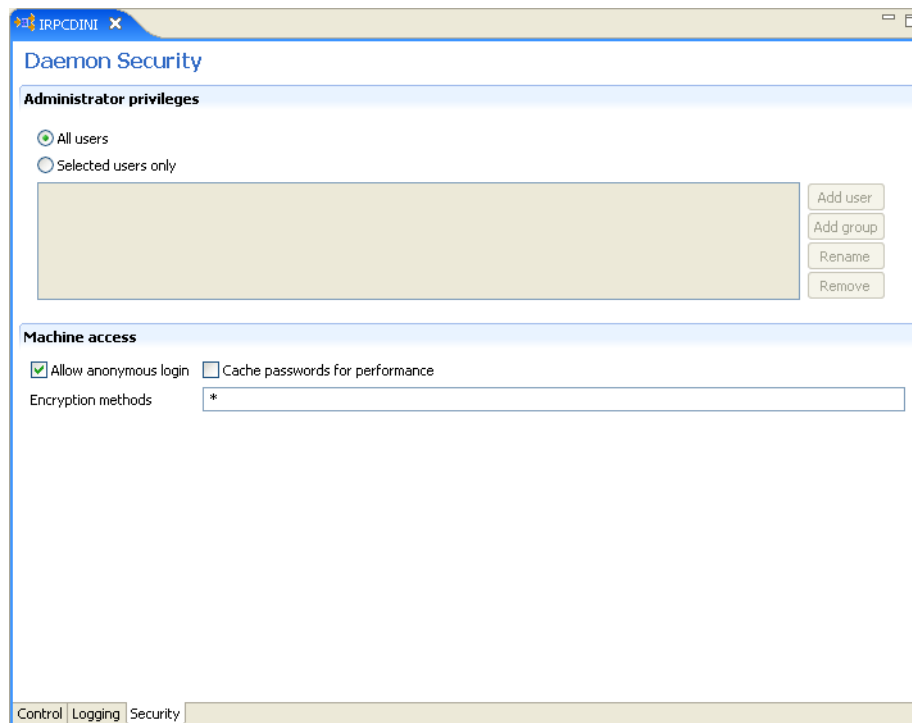

The **Daemon Security** tab comprises fields, as listed in the following table:

Table B-3 Daemon Security tab Components

Field	Description
Administrators privileges	Identifies the users (accounts) allowed to perform administrative tasks (tasks that require administrative login).
All users	Enables all users to access the daemon and change the settings.
Selected users only	Identifies the names of users (accounts) and groups that can be administrators. ¹ If a user is not specified, the account from which the daemon was started is considered the administrator. Note that the daemon does not require the user to log in to the account on the system, but to log in to the daemon using the account name and password.
Machine access	Manages access to the computer.
Allow anonymous login	Whether workspaces allow anonymous logins (without user name/password entries). For the optimal level of security, keep this option unchecked and define a user name for the Daemon Administrators parameter. If unchecked, then no workspace can have an anonymous client. If checked, then a particular workspace allows anonymous clients.
Cached password	Enables login passwords to be cached. This enhances performance by reducing login times for future connections from the same client in a session.
Encryption methods	Specifies the encryption method used to send information across the network. The default is an asterisk (*), meaning that all methods are acceptable. If an encryption method is specified, it must be used. The RC4 and DES3 protocols are currently supported.

¹ The name is prefixed with '@', to use the operating system GROUP feature.

B.4 Workspaces

A daemon can include several workspaces. A workspace defines the server processes and environment that are used for the communication between the client and the server for the duration of the client request. Each workspace has its own definition. The workspace definition is divided into the following groups:

- [General](#)
- [Server Mode](#)
- [Security](#)

B.4.1 General

Using the **General** tab, you enter general information about the features that control the operation of the workspace, such as the server type, the command procedure used to start the workspace and the binding configuration associated with this workspace.

Do the following to open the **General** tab:

1. From the **Start** menu, select **Programs, Oracle**, and then select **Studio**.
2. From the Design perspective Configuration view, expand the **Machines** folder.

3. Right-click a computer and select **Open Runtime Perspective**.
4. Expand the Daemons node to display the workspaces in the Runtime Explorer.
5. Right-click the workspace and select **Edit Workspace Configuration**. The **General** tab opens.
6. After making changes to the workspace, right-click the daemon and select **Reload Configuration**.

Note: You can also change daemon settings using the Configuration Explorer, by selecting a computer and scrolling the list to the required daemon. Right-click the daemon and select **Edit Daemon**.

Changes made to the daemon configuration are not implemented. They are only implemented after the configuration is reloaded using the **Reload Configuration** option in the Runtime Manager.

7. Right-click the daemon and select **Recycle Servers**. Any servers in the connection pool are closed and new servers start with the new configuration.

The **General** tab is shown in the following figure:

Figure B-4 The General tab

The **General** tab comprises fields, as listed in the following table:

Table B-4 General Tab Components

Field	Description
Info	

Table B-4 (Cont.) General Tab Components

Field	Description
Workspace name	The name used to identify the workspace. Note: The default configuration includes the default Navigator workspace. This workspace is automatically used if a workspace is not specified as part of the connection settings.
Description	A description of the workspace.
Startup script	The full path name of the script that starts the workspace server processes. The script specified here must always activate the <code>nav_login</code> procedure and then run the server program (<code>svc</code>). If you do not specify the directory, the startup procedure is taken from the directory where the daemon resides. Oracle Connect includes a default startup script, which it is recommended to use.
Server type	This field is not applicable for use with OracleAS Adapters for VSAM.
Workspace binding name	This field is not applicable for use with OracleAS Adapters for VSAM.
Timeout parameters	The time the client waits for the workspace server to start. If the workspace server does not start within this period, then the client is notified that the server did not respond. Specifying the timeout here overrides the default setting, specified in the Control section. For more information, see Control for details about the Daemon Control section.
Client idle timeout	The maximum amount of time a workspace client can be idle before the connection with the server is closed.
Connect timeout	The time the client waits for a workspace server to start. If the workspace server does not start within this period, then the client is notified that the server did not respond.
Call timeout	The timeout period for <i>short</i> calls for all daemons. The definition of a short call is a call that should be completed in a few seconds. For example, most calls to a database such as <code>DESCRIBE</code> should be completed in a few seconds as opposed to call like a <code>GETROWS</code> call, which can take a long time. In heavily loaded or otherwise slow systems, even short calls such as calls to open a file, may take a significant amount of time. If a short call takes more than the specified time to complete, then the connection is stopped. The default value for this parameter is 60 seconds. Values of less than 60 seconds are considered to be 60 seconds. Specifying the timeout in a workspace overrides the value set in this field for that workspace.

Logging and Trace Options

Table B-4 (Cont.) General Tab Components

Field	Description
Specific log file format	<p>Defines the name and location of the server log file if you want the data written to a file instead of SYSOUT for the server process. The parameter must specify the name and the high level qualifier.</p> <p>The following tokens can appear in the log file template and are replaced accordingly:</p> <ul style="list-style-type: none"> ■ %A: workspace name ■ %D: date (yymmdd) ■ %I: instance number of the given workspace server ■ %L: server account's login directory ■ %P: server's process ID ■ %T: time (hhmmss) ■ %U: server's account name (user name)
Trace options	<p>Specifies the type of tracing to be performed. The following tracing options are available:</p> <ul style="list-style-type: none"> ■ No timeout: Select this to disable the standard RPC timeouts, setting them to a long duration (approximately an hour) to facilitate debugging. ■ Call trace: Select this to generate a message in the server log file for each RPC function called. This is useful for troubleshooting the server. ■ RPC trace: Select this to enable debugging messages on the server. ■ Sockets: Select this to generate a message in the server log file for each socket operation. This is useful for troubleshooting client/server communication - providing a detailed trace of every client/server communication. ■ Extended RPC trace: Select this to generate a verbose message in the server log file for each low-level RPC function called. This is useful for troubleshooting the server. ■ System trace: Select this to generate operating system-specific tracing. ■ Timing: Select this to generate a time stamp for every entry to the server log file.
Query governing restrictions	
Max number of rows in a table that can be read	Select the maximum number of table rows that are read in a query. When the number of rows read from a table exceeds the number stated the query returns an error.
Max number of rows allowed in a table before scan is rejected	<p>Select the maximum number of table rows that can be scanned. This parameter has different behavior for query optimization and execution.</p> <ul style="list-style-type: none"> ■ For query optimization, the value set is compared to the table cardinality. If the cardinality is greater than the value, the scan strategy is ignored as a possible strategy (unless it is the only available strategy). ■ For query execution, a scan is limited to the value set. When the number of rows scanned exceeds the number entered, the query returns an error.

B.4.2 Server Mode

The Server Mode tab lets you configure the features that control the operation of the servers started up by the workspace and allocated to clients.

For example, you can configure the workspace to start several servers for future use before any client request, instead of starting each server when a request is received from a client.

Do the following to open the **Server Mode** tab:

1. From the **Start** menu, select **Programs, Oracle**, and then select **Studio**.
2. From the Design Perspective Configuration view, expand the **Machines** folder.
3. Right-click the computer and select **Open Runtime Perspective**.
4. Expand the Daemons node to display the workspaces in the Runtime Explorer.
5. Right-click the workspace and select **Edit Workspace Configuration**.
6. Click the **Server Mode** tab.
7. After making changes to the workspace, right-click the daemon and select **Reload Configuration**.

Notes:

- You can also change daemon settings using the Configuration Explorer, by selecting a computer and scrolling the list to the required daemon. Right-click the daemon and select **Edit Daemon**.
 - Changes made to the daemon configuration are not implemented. They are only implemented after the configuration is reloaded using the **Reload Configuration** option in the Runtime Manager.
-
-

8. Right-click the daemon and select **Recycle Servers**. Any servers in the connection pool are closed and new servers start with the new configuration.

The **Server Mode** tab is shown in the following figure:

Figure B-5 The Server Mode tab

Workspace Server Mode

Server

Workspace server mode: [dropdown]

Port range: From 0 To 0

Use default port range

Maximum number of server processes: 0

Limit server reuse: 50

Limit concurrent clients per server: 0

Specify server priority: 0

Use default server priority

Keep when daemon ends

Server Provisioning

Number of prestarted servers in pool: 0

Number of spare servers: 0

Prestarted server pool limit: 0

Resource limitations

Number of sub-tasks (OS/390 specific): 0

General | Server Mode | Security

The **Server Mode** tab has the following fields:

Table B-5 Server Mode Tab Components

Field	Description
Workspace server mode	<p>Specifies the type of new server processes that the daemon starts. The daemon supports the following server modes:</p> <ul style="list-style-type: none"> ▪ singleClient: Each client receives a dedicated server process. The account in which a server process runs is determined either by the client login information or by the specific server workspace. <p>This mode enables servers to run under a particular user account and isolates clients from each other, as each receives its own process. However, this server mode incurs a high overhead due to process startup times and can use a lot of server resources as it requires as many server processes as concurrent clients.</p> ▪ multiClient: Clients share a server process and are processed serially. This mode has low overhead because the server processes are initialized. However, because clients share the same process, they can impact one another, especially if they issue lengthy queries. The number of clients that share a process is determined by the Clients per server limit field. ▪ multiThreaded: This mode is not applicable for use with OracleAS Adapter for VSAM. ▪ reusable: An extension of single-client mode. Once the client processing finishes, the server process does not die and can be used by another client, reducing startup times and application startup overhead. <p>This mode does not have the high overhead of single-client mode because the servers are initialized. However, this server mode can use a lot of server resources as it requires as many server processes as concurrent clients.</p> <p>Note: The other modes can be set so that the server processes are reusable. The Reuse limit field value controls the number of times a process can be reused.</p>
Reuse limit	<p>Sets the maximum number of times a particular server can be reused. A one-client server can be reused after its (single) client has disconnected. Reuse of servers enhances startup performance because it is not necessary to repeat initialization. The default for this field is none (0), indicating that server reuse is unlimited. This parameter is disabled only if the server mode value is singleClient.</p>
Clients per server limit	<p>Sets the maximum number of clients a server process for the current workspace accepts. The default for this field is none (0), indicating that the number of clients for each server is unlimited. This field is enabled only if the server mode value is multiClient or multiThreaded.</p>

Table B-5 (Cont.) Server Mode Tab Components

Field	Description
Server availability	<p>Specifies the number of servers in a pool of servers, available to be assigned to a client.</p> <p>The following options are available:</p> <ul style="list-style-type: none"> ▪ Initial number of servers: The number of server processes that are prestarted for this workspace when the daemon starts. When the number of available server processes drops lower than the value specified in the Minimum number field, the daemon again starts server processes until this number of available server processes is reached. The default for this field is 0. ▪ Minimum number: The minimum number of server processes in the prestarted pool before the daemon resumes creating new server processes (to the value specified in the Initial number of servers field). If this field is set to a value higher than the Initial number of servers field, the daemon uses the value specified in the Initial number of servers field. The default for this field is 0. ▪ Keep when daemon ends: When a daemon is shutdown, all the servers started by that daemon are also stopped, even if they are active. Set this field to <code>true</code> if you want the servers for the workspace to remain active, even after the daemon has been shut down. If this field is set to <code>true</code>, it is the responsibility of the system operator or manager to ensure that the servers are eventually stopped. This must be done at the system level. ▪ Set maximum number of servers: The maximum number of available server processes. Once this number is reached, no new nonactive server processes are created for the particular workspace. For example, if several server processes are released at the same time, so that there are more available server processes than specified by this field, the additional server processes higher than this value are terminated. The default for this field is zero, meaning that there is no maximum.
Port range	<p>Determines the range of ports available for this workspace when starting server processes. Use this option when you want to control the port number, so that Oracle Connect can be accessed through a firewall.</p> <p>Enter the port range in the following fields:</p> <ul style="list-style-type: none"> ▪ From: enter the lowest numbered port in the range. ▪ To: Enter the highest numbered port in the range.
Use default port range	Select this to use the port range that is defined in the daemon. This is defined in the Port range for servers field in the daemon Control tab.
Maximum number of server processes	Enter the maximum number of server processes that can run at the same time.
Limit server reuse	Select this to limit the number of servers that can be reused. If this is selected, the Reuse limit parameter is available.

Table B-5 (Cont.) Server Mode Tab Components

Field	Description
Limit concurrent clients per server	<p>If Limit server reuse is selected, in the field next to the check box, enter the maximum number of times a server can be reused. Select the maximum of clients accepted in a server process.</p> <p>A one-client server can be reused after its (single) client has disconnected. Reuse of servers enhances startup performance because it is not necessary to repeat initialization.</p> <p>This parameter is not available if the Limit server reuse parameter is not selected.</p> <p>This parameter is not available if the server mode value is singleClient.</p>
Specify Server Priority	<p>Select this to limit the number of clients that a server can accept for the current workspace process.</p> <p>If this is not selected, the number of clients is unlimited.</p> <p>If Limit concurrent clients per server is selected, in the field next to the check box, enter the maximum number of clients that a server process for the current workspace accepts. The default for this field is None, indicating that the number of clients for each server is unlimited. This field is available if the server mode value is multiClient or multiThreaded.</p> <p>Set the priority for servers. For example, a workspace for applications with online transaction processing can be assigned a higher priority than a workspace that requires only query processing. The lower the number, the higher the priority. For example, workspaces with a priority of 1 are given a higher priority than workspaces with a priority of 2.</p> <p>Note: This is unavailable if Use default server priority is selected.</p>
Use default server priority	<p>Sets the priority to 0. There is no specific priority for this workspace. Clear this check box to set a priority in the Specify server priority parameter.</p>
Keep when daemon ends	<p>Select this to stop all servers started by that daemon when a daemon is shutdown, even if they are active. Select this if you want the servers for the workspace to remain active, even after the daemon has been shut down. If selected, it is the responsibility of the system operator or manager to ensure that the servers are eventually stopped. This must be done at the system level.</p>
Server Provisioning	
Number of prestarted servers in pool	<p>Initial number of servers: The number of server processes that are prestarted for this workspace when the daemon starts. When the number of available server processes drops lower than the value specified in the Minimum number field, the daemon again starts server processes until this number of available server processes is reached. The default for this field is 0.</p>

Table B-5 (Cont.) Server Mode Tab Components

Field	Description
Number of spare servers	The minimum number of server processes in the prestarted pool before the daemon resumes creating new server processes (to the value specified in the Initial number of servers field). If this field is set to a value higher than the Initial number of servers field, the daemon uses the value specified in the Initial number of servers field. The default for this field is 0.
Prestarted server pool limit	The maximum number of available server processes. Once this number is reached, no new nonactive server processes are created for the particular workspace. For example, if several server processes are released at the same time, so that there are more available server processes than specified by this field, the additional server processes higher than this value are terminated. The default for this field is zero, meaning that there is no maximum.
Resource limitations	
Nuber of sub-tasks	The number of sub-tasks for a server that are prestarted for this workspace when the daemon starts. In addition to setting up a pool of server processes as described earlier, you can set additional server processes as sub-tasks by specifying this parameter. If you set 10 servers and 10 prestarted sub-tasks then 100 tasks are started (10 sub-tasks for each process).

B.4.3 Security

The **Security** tab lets you configure the security level for a workspace. This lets you set the security options for the workspace only. The Security tab is used to:

- Grant administration rights for the workspace
- Determine access to the workspace by a client

Do the following to open the **Security** tab:

1. From the **Start** menu, select **Programs, Oracle**, and then select **Studio**.
2. From the Design Perspective Configuration view, expand the **Machines** folder.
3. Right-click the computer and select **Open Runtime Perspective**.
4. Expand the Daemons node to display the workspaces in the Runtime Explorer.
5. Right-click the workspace and select **Edit Workspace Configuration**.
6. Click the **Security** tab.
7. After making changes to the workspace, right-click the daemon and select **Reload Configuration**.

Notes:

- You can also change daemon settings using the Configuration Explorer, by selecting a computer and scrolling the list to the required daemon. Right-click the daemon and select **Edit Daemon**.
- Changes made to the daemon configuration are not implemented. They are only implemented after the configuration is reloaded using the **Reload Configuration** option in the Runtime Manager.

8. Right-click the daemon and select **Recycle Servers**. Any servers in the connection pool are closed and new servers start with the new configuration.

The **Security** tab is shown in the following figure:

Figure B-6 The Security tab

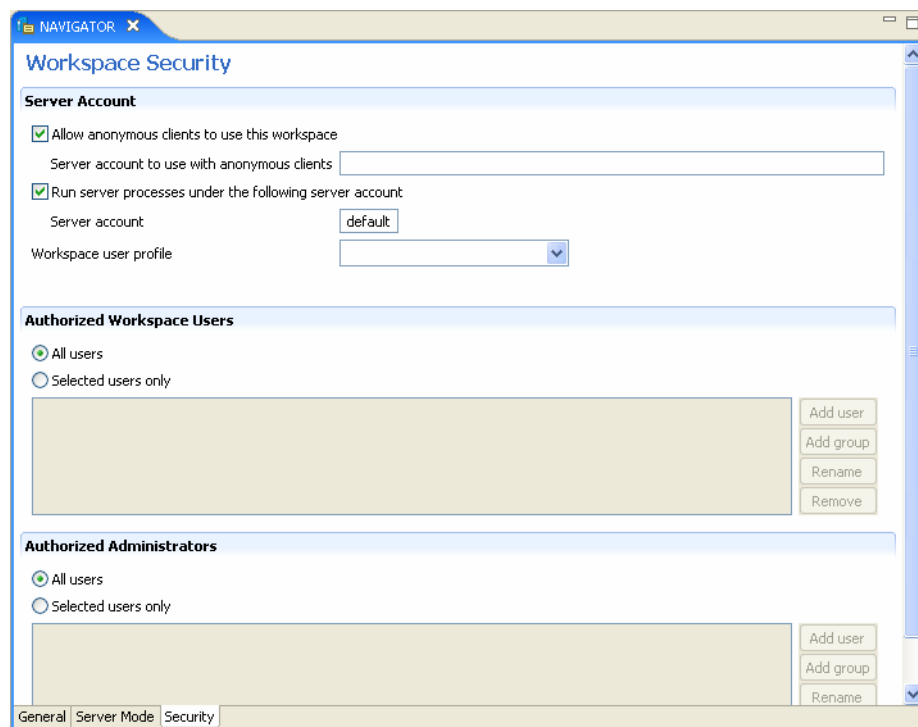

The **Security** tab has the following fields:

Table B-6 Security Tab

Field	Description
Server Account	This section defines the users (accounts) allowed to access the workspace, firewall access ports, workspace account, and anonymous login permissions.
Use specific workspace account	Select this to define the operating system account used for the workspace. If selected, enter the name of the workspace account in the workspace account field. If not selected, the account name that was provided by the client is used.
Allow anonymous clients to use this workspace	Select this to allow this workspace to be invoked without authentication. If selected, enter the name of the workspace account in the Server account to use with anonymous clients field.
Authorized Workspace users	Indicate which users have permission to use the workspace. Select one of the following <ul style="list-style-type: none"> ■ All users: Any user who has logged on to the daemon may use the workspace ■ Selected users only: Select this to allow only users (or accounts) with specific permission to use the workspace. When this is selected, add the names of users (or accounts) and groups that can be use the workspace in the field below. Note: If no user is specified, any user who has logged on to the daemon may use the workspace.
Authorized Administrators	Identifies the users (accounts) with administrator privileges. Select one of the following: <ul style="list-style-type: none"> ■ All users: Indicates that anyone can access the workspace and change the settings. ■ Selected users only: Select this to allow only users (or accounts) with specific permission to be administrators. When this is selected, add the names of users (or accounts) and groups that can be workspace administrators. If no user is specified, any user who has logged on to the daemon may administrator this workspace.

Editing Properties for the OracleAS CDC Adapter for VSAM

The OracleAS CDC Adapter for VSAM has several configuration properties. You can edit the properties in Oracle Studio after [Setting Up a Change Data Capture with the OracleAS CDC Adapter for VSAM](#). This chapter describes the configuration properties and how to edit them. It contains the following sections:

- [Editing Properties in Oracle Studio](#)
- [Configuration Properties](#)
- [Access to Change Events](#)
- [Transaction Support](#)
- [Security](#)

C.1 Editing Properties in Oracle Studio

After you create the OracleAS CDC solution, you can also edit the properties. The solution create two adapters, the adapter and the CDC Queue adapter. The adapter is created on the server computer and the CDC Queue adapter is created on the staging area computer. For more information, see [Setting up a Change Data Capture in Oracle Studio](#).

C.1.1 Editing the OracleAS CDC Adapter Properties

To edit the CDC adapter properties, open the Oracle Studio Design perspective and find the binding for the CDC solution on the server computer. Then open the adapter, which contains the name of the CDC solution with the suffix `_ag` added to it. Changes to adapter properties are reset when the CDC solution is redeployed, therefore these changes must be reapplied following solution deployment. For information on deploying a solution, see [Deploying a Change Data Capture](#).

Do the following to edit the CDC adapter properties.

1. From the **Start** menu, select, **Programs, Oracle**, and then select **Studio**.
2. Expand the **Machines** folder.
3. Expand the server machine that you created when [Setting up a Change Data Capture in Oracle Studio](#).
4. Expand the **Bindings** folder, and then expand the binding the name of the CDC solution with the suffix `_ag` added to it.
5. Expand the **Adapter** folder.

6. Right-click the adapter the adapter with the name of the solution and the suffix `_ag` and select **Open**.
The adapter configuration editor opens in the editor, which displays the properties for the adapter.
7. Edit the adapter parameters as required.
For more information, see [OracleAS CDC Adapter Configuration Properties](#) for a description of the properties.

C.2 Configuration Properties

This section describes the configuration properties for the OracleAS CDC Adapter for VSAM. You can edit the properties using Oracle Studio. The OracleAS CDC Adapter for VSAM has the following types of properties:

- [CDC Logger Properties](#)
- [CDC\\$PARM Properties \(VSAM Batch Only\)](#)
- [OracleAS CDC Adapter Configuration Properties](#)
- [Change Router Properties](#)
- [Referential Integrity Considerations](#)

C.2.1 CDC Logger Properties

`LoggerName`: the name of the MVS logstream used for the data capture.

C.2.2 CDC\$PARM Properties (VSAM Batch Only)

`CDC$PARM` is the name of DD card that defines a QSAM data set or PDS member that contains the parameters for the JRNAD exit and Logical Transaction Management. For more information on the creation and syntax, see [Configuring the Logger \(VSAM Batch Only\)](#).

Note: The Oracle Connect CDC VSAM Batch solution automatically sets its own JRNAD user exit routine during the open process of a VSAM cluster (if another JRNAD exit is in use, the solution cannot work).

Make changes to the corresponding jobs to:

- Provide the OracleAS CDC Adapter for VSAM Batch hook for automatic JRNAD definition
 - Manage Logical Transactions (for more information, see [Logical Transaction Manager](#))
-

Table C-1 *CD\$PARM Values*

Name	Valid Values	Default	Comment
BEFORE_IMAGE	YES/NO	YES	Write before image to logstream
BLOCKING	YES/NO	YES	Use blocking write
DEBUG	OFF/ON	OFF	Print debug info using WTO

Table C-1 (Cont.) CD\$PARM Values

Name	Valid Values	Default	Comment
DSNAME	*/<cluster name>	*	VSAM cluster that should be captured; An asterisk (*) indicates that all the VSAM clusters opened with Oracle JRNAD should be captured. Each DSNAME defines only one cluster. You may provide up to 50 clusters.
ERROR	IGNORE/ABEND	ABEND	When IGNORE is used, mostabnormal situations cause a warning message and the process terminates.
LOGICAL_TRANSACTION	YES/NO	YES	Allows the use of the Logical Transaction Manager
LOGSTREAM	<Logstream name>	Oracle. CDC.VSA MBTCH	The name of the used MVS logstream
OPER	UPD/DEL/INS	All	Defines the type of operations that are written to the logstream.
SHOW_DUMMY_RECORDS	OFF/ON	OFF	Ignore dummy records used for empty KSDS cluster access.
SYNC_WRITE	YES/NO	YES	Use synchronize logstream write.

C.2.3 OracleAS CDC Adapter Configuration Properties

This section describes the common configuration properties for Oracle CDC adapters and the change router configuration properties, which is located on the staging area computer.

To edit the CDC adapter properties, open the Oracle Studio Design perspective and find the binding for the CDC solution you created. The binding contains the name of the CDC solution with the suffix `_ag` added to it. Open the adapter with the name of the solution and the suffix `_ag` to edit the properties. For information on how to edit adapter properties in Oracle Studio, see [Editing the OracleAS CDC Adapter Properties](#). Changes to adapter properties are reset when the CDC solution is redeployed, therefore these changes must be reapplied following solution deployment.

For a description of the configuration properties see the following topics :

- [CDC Queue Adapter Properties](#)
- [Common CDC Adapter Properties](#)

C.2.3.1 CDC Queue Adapter Properties

The CDC Queue adapter is a data base adapter that is found in the staging area. It is created automatically when [Setting up a Change Data Capture in Oracle Studio](#). It has three properties:

- `connectString`
- `defaultDatasource`
- `multipleResults`

To ensure that the queue adapter works properly with your CDC solution, do not change the values for these properties.

The CDC Queue adapter may have additional properties that can be viewed in the adapter's XML schema. For information on how to view the XML, see [Adapter Metadata XML](#).

The following property, which is viewed in the XML only can be edited:

- `maxRecords`: The maximum number of records that can be returned.

For information on how to edit XML records in Oracle Studio, see [Advanced Tuning of the Metadata](#).

C.2.3.2 Common CDC Adapter Properties

The following table describes the common configuration properties for Oracle CDC adapters. The OracleAS CDC Adapter for VSAM uses only these properties.

Table C-2 CDC Adapter Configuration Properties

Parameter	Type	Default	Description
<code>datasource</code>	string		The name of the data source for the OracleAS CDC Adapter .
<code>routers</code>			<p>A list of users who can connect to the adapter and get change events from it for processing. If no routers are specified, any valid user for the workspace can get change events from the Oracle Connect adapter.</p> <p>To add the list of users in Oracle Studio, expand the <code>router</code> property then right-click <code>users</code>. A new entry called <code>Item(#)</code> is added to the Property column. In the Value column, enter the User Name for this router.</p>
<code>retryInterval</code>	int	2	The polling interval for the database journal. When no events are received in the database journal, the adapter waits for the amount of time (in seconds) that is indicated for this property.
<code>getTransactionInfo</code>	boolean	true	When set to <code>true</code> , transaction information (<code>begin</code> , <code>commit</code> , <code>rollback</code>) is returned.
<code>getBeforeImage</code>	boolean	false	When <code>true</code> , before image information is returned.
<code>realTime</code>	boolean	true	<p>When <code>true</code>, this reduces latency in getting change events, however it also increases the polling of the database journal.</p> <p>The change router asks for N events from the adapter. If the adapter finds fewer than N events in the database journal and <code>realTime</code> is <code>true</code>, these events are immediately returned to the change router. If <code>realTime</code> is <code>false</code>, the adapter polls the journal again after waiting for the number of seconds indicated in the <code>retryInterval</code>.</p>

Table C–2 (Cont.) CDC Adapter Configuration Properties

Parameter	Type	Default	Description
logLevel			The logging level. The following are the available log levels: <ul style="list-style-type: none"> ■ none ■ api ■ internalCalls ■ info ■ debug
checkTimeoutEveryNEvents	int	100	The number of events that occur before the CDC adapter checks the <code>timeout</code> value. For example, if this property is set to 100, the adapter checks the <code>timeout</code> value after 100 events have taken place. If the amount of time set in the <code>timeout</code> property is past, the adapter times out.

C.2.4 Change Router Properties

The following table describes the SQL-based change event router configuration parameters.

To edit the router properties, open the Oracle Studio Design perspective and find the binding for the CDC solution you created. The binding contains the name of the CDC solution with the suffix `_router` added to it. Open the adapter with the name of the solution and the suffix `_router` to edit the properties. For information on how to edit adapter properties in Oracle Studio, see [Editing the OracleAS CDC Adapter Properties](#).

Table C–3 Change Router Configuration Parameters

Parameter	Type	Default	Description
cdcDatasource	string		The OracleAS Change Data Source.
eliminateUncommittedChanges	Boolean	false	When set to <code>true</code> , only committed change records are moved to the Change Table. If <code>false</code> , all change records are moved to the change tables (in which case, memory usage is minimal) hence the change table may contain rolled back data. For most adapters, following the RI considerations results in rolled-back changes eliminated naturally by compensating change records generated by the adapter in a rollback. Consult the respective CDC adapter documentation for details. For more information, see Referential Integrity Considerations .

Table C-3 (Cont.) Change Router Configuration Parameters

Parameter	Type	Default	Description
eventExpirationHours	int	48	Indicates how long change records are kept in change tables within the staging area. After the indicated time, change records are deleted. You can set a value between 0 and 50000. A value of 0 means that the records are never deleted. A value of 1 indicates that the records are kept for one hour.
logLevel	enum		The logging level for the router. The following are the available log levels: <ul style="list-style-type: none"> ▪ none ▪ api ▪ internalCalls ▪ info ▪ debug.
maxDeletedEventsInBatch	int	500	Controls how many expired change records are delete in a single pass. In some rare cases, it may be necessary to lower this value to reduce latency when a large number of change events is continuously being received.
maxOpenfiles	int	200	Controls the number of physical files opened by the router.
maxTransactionMemory	int (in Kb)	1000	Specifies how much memory can be stored in memory per transaction before it is off-loaded to disk. This number should be higher than the average transaction size so that the slower-than-memory disk is not used too often.
maxStagingMemory	int (in Kb)	10000 0	Specifies how much memory in total can be used for storing active transactions (ones that have not yet committed or rolled back).
sourceEventQueue	Structure:		Connection information to the OracleAS CDC Adapter .
▪ server	string		
▪ workspace	string		
▪ adapter	string		
▪ eventWait	int	30	
▪ maxEventsAsBlocks	int	250	
▪ reconnectWait	int	15	
▪ fixedNat	boolean	false	
stagingDirectory	string		Specifies the directory where the staging area change files are stored. This directory also stores off-loaded transactions, timed-out transactions, and error files.

Table C-3 (Cont.) Change Router Configuration Parameters

Parameter	Type	Default	Description
transactionTimeout	int (in seconds)	3600	Specifies how long can a transaction be active without getting new events. This parameter should be set according to the corresponding setting of the captured database. In particular, this setting must not be lower than the database's transaction time-out setting as this may lead to the loss of transactions.
useType	enum	sqlBased Cdc	This parameter must be set to this value.
routers			<p>A list of users who can connect to the change event router and get change events from it for processing. If no routers are specified, any valid Oracle Connect user for the workspace may get change events from the adapter.</p> <p>To add the list of users in Oracle Studio, expand the <code>router</code> property then right-click <code>users</code>. A new entry called <code>Item(#)</code> is added to the Property column. In the Value column, enter the User Name for this router.</p>
senders			<p>A list of users who can connect to the change event router and send change events to it for processing. If no routers are specified, any valid Oracle Connect user for the workspace may get change events from the adapter.</p> <p>To add the list of users in Oracle Studio, expand the <code>sender</code> property then right-click <code>users</code>. A new entry called <code>Item(#)</code> is added to the Property column. In the Value column, enter the User Name for this router.</p>
subscribeAgentLog	Boolean	False	When set to <code>true</code> , the change router writes the contents of the OracleAS CDC Adapter's log in to its own log. Do not set this property to <code>true</code> if the <code>logLevel</code> property is set to <code>debug</code> because the large amount of information that is sent in this mode causes performance delays.
nodeID	string		ID for a node when using multi-router mode. Each node represents a router.

Table C-3 (Cont.) Change Router Configuration Parameters

Parameter	Type	Default	Description
alternativeOwnerSeparator	string	..	This is the value of the separator that is used to separate the name of the owner and the suffix table. In Oracle Studio, the default separator for the staging area is an underscore (_). For example, owner.table. When using SSIS to configure a CDC solution, an underscore causes an error. When you change the default separator in the Oracle Studio Preferences window, the new value is entered in this property.

C.2.5 Referential Integrity Considerations

Some related tables have referential integrity (RI) constraints enforced on them. For example, with `OrderHeader` and `OrderLines` one cannot have `OrderLines` without an associated `OrderHeader`.

When processing change events by the table (which is how an OracleAS CDC works) as opposed to by transaction, referential integrity cannot be maintained properly. For example, when first handling all `OrderHeader` records and then all `OrderLines` records then a deleted `OrderHeader` may be applied long before the required delete of the associated `OrderLines` records.

In order to reduce the potential referential integrity to a known time frame after which referential integrity is restored, a somewhat different process is needed (compared with Reading the Change Tables').

A special `SYNC_POINTS` table should be added to maintain a common sync-point for use with multiple related tables. The table is defined as follows:

Table C-4 SYNC_POINTS Table Structure

Column Name	Data Type	Description
application_name	string (64)	The application for which the processing is done.
table_name	string (64)	The name of the synchronization point
context	String (32)	A stream position that can be safely used as an upper bound for event retrieval of all related tables

This table's primary unique key is the concatenation of `application_name` + `sync_name`. The use of this table is not mandatory but it is part of the recommended use pattern of SQL-based CDC.

The `SYNC_POINTS` table is created with the following definition (where filename is changed into an actual path):

```
<?xml version='1.0' encoding='UTF-8'?>
<navobj>
  <table name='SYNC_POINTS'
    fileName='<staging-directory-path>SYNC_POINTS' organization='index'>
    <fields>
      <field name='application_name' datatype='string' size='64' />
      <field name='sync_name' datatype='string' size='64' />
      <field name='context' datatype='string' size='32' />
    </fields>
  </table>
</navobj>
```

```

<keys>
  <key name='Key0' size='128' unique='true'>
    <segments>
      <segment name='application_name' />
      <segment name='sync_name' />
    </segments>
  </key>
</keys>
</table>
</navobj>

```

The following procedure describes how to ensure RI is regained after a group of ETL rounds. It is an extension of the procedure described earlier for consuming change records. Here we assume that tables T1, T2 and T3 are related with RI constraints and that A is the application we are working under.

To create a stream position

1. This is a one-time setup step aimed to create a stream position record for T [1/2/3] + A in the STREAM_POSITIONS table. The following SQL statement creates that record:

```

insert into STREAM_POSITIONS values ('A', 'T1', '');
insert into STREAM_POSITIONS values ('A', 'T2', '');
insert into STREAM_POSITIONS values ('A', 'T3', '');

```

2. This step is performed at the beginning of a group of ETL rounds processing (that is before starting to process change events for T1, T2 and T3). The goal here is to get a shared sync point for retrieval of T1, T2 and T3. This is done by sampling the 'context' column of the SERVICE_CONTEXT table. This value is the stream position of the last change record in the most recently committed transaction. This is done as follows:

```

insert into SYNC_POINTS
  select 'A' application_name, 'T123' sync_name, context from SERVICE_
CONTEXT;

```

Here, T123 is the name chosen for the synchronization [points of tables T1, T2, and T3.

3. This step is where change data is actually read. It occurs on each ETL round.

```

select n.* from T t, STREAM_POSITIONS sp, SYNC_POINTS sy where
  sp.application_name = 'A' and
  sp.table_name = 'T' and
  sy.application_name = sp.application_name and
  sy.sync_name = 'T123' and
  n.context > sp.context and n.context <= sy.context order by n.context;

```

Note that “n.context <= sy.context” is used because the context represents a change record to be processed and processing should include the change record associated with sy.context, too.

This query retrieves change records starting from just after the last handled change record but stopping at a common sync point. “n.*” can be replaced with an explicit list of columns, however it is important that the 'context' column must be selected as this is the change record stream position which is required for the next step.

This step occurs after each ETL round when all change records were retrieved and processed for a table Ti. Let's assume that the value of the 'context' column of the

last change record was 'C'. This value must be stored back into the STREAM_POSITION table for the next ETL round. This is done with:

```
update STREAM_POSITIONS set context='C' where application_name 'A' and table_name = 'Ti';
```

This value can be stored more frequently during the ETL process as needed. The general guideline is that when change record data has been committed to the target database, the stream position should be updated as well.

C.3 Access to Change Events

Changes are captured and maintained in a change table. The table contains the original table columns and CDC header columns. The header columns are described in the following table:

Table C-5 Header Columns

Column Name	Description
context	<p>The change record stream position in the staging area. The column is defined as primary unique index. It is a 32-bytes string with the following structure:</p> <pre><yyyymmdd>T<hhmmss>.<nnnn><cccccc></pre> <p>Where:</p> <ul style="list-style-type: none"> ▪ <yyyymmdd>T<hhmmss> is the commit processing timestamp as generated in the staging area when starting to process the Commit event. ▪ <nnnn> is a unique number to differentiate between transactions committed during the same second (up to 99,999 are assumed). ▪ <cccccc> is a counter for the change events in the transaction making every stream position unique (up to 9,999,999 are assumed).
operation	<p>This column lists the operations available for the CDC adapter. The available operations are:</p> <ul style="list-style-type: none"> ▪ INSERT ▪ DELETE ▪ ¹DELETALL (available in cases where a COBOL output file is opened in CLEAN ALL mode and an event with a DELETEALL operatin is initiated) ▪ UPDATE ▪ BEFOREIMAGE ▪ COMMIT ▪ ROLLBACK
transactionID	The operation's transaction ID.
terminalID	The terminal ID that originated the change.
taskID	The task ID originating the change.

Table C-5 (Cont.) Header Columns

Column Name	Description
tableName	The name of the table where the change was made. For INSERT, UPDATE, and BEFOREIMAGE operations, the owner name and then the table name are displayed. For COMMIT and ROLLBACK operations, this value is the same as the OPERATION value.
timestamp	The date and time of the occurrence.
jobName (VSAM Batch only)	The name of the job that caused the VSAM update.
programName (VSAM Batch only)	The name of the program that changed the VSAM data.
userName (VSAM Batch only)	The name of the user running the job.
stepName (VSAM Batch only)	The name of the step in the job.
procedureStepName (VSAM Batch only)	The name of the procedure name run by the step.
programStartTimestamp (VSAM Batch only)	The time when the program started to be executed.

¹ DELETEALL is relevant for VSAM Batch only.

The data portion is an exact copy of the back-end table layout.

Each change in the journal is captured as an event with the following format:

```
<event name='table_name' timestamp='...'>
  <table_name>
    <header ...></header>
    <data ...></data>
  </table_name>
</event>
```

C.4 Transaction Support

The OracleAS CDC Adapter for VSAM supports transactions in their CICS boundaries.

For the OracleAS CDC Adapter for VSAM Batch, there are two types of transaction management:

- [Single Program Transaction Manager](#)
- [Logical Transaction Manager](#)

C.4.1 Single Program Transaction Manager

By default, changes that are made by a single program (PGM) are designated as a transaction. In this case, the OracleAS CDC Adapter for VSAM Batch hook sets its own LE termination routine to get the program severity and user return codes.

The return codes determine whether the transaction is terminated with COMMIT or ROLLBACK. By default, any severity code less than 2 and any return code less than or equal to 4 (that is a warning return code or a successful return code) result in COMMIT. All other values result in ROLLBACK. Use the CDC agent properties

`commitMaxTerminationSeverityCode` and `commitMaxTerminationUserCode` to adjust the default behavior.

C.4.2 Logical Transaction Manager

It is common practice to set up nightly batch jobs to update VSAM clusters to ensure consistency. This is done by maintaining a copy of the VSAM data before the job is run and restoring the previous copy if the batch job is terminated abnormally for any reason. This practice can be viewed as an implementation of a logical transaction that ensures that an entire batch job runs as a unit of work.

With a OracleAS CDC Adapter for VSAM Batch solution, it is important to maintain the same work unit. In this case, the changes should not be delivered to the client application until the entire logical transaction successfully completes. Failure to maintain such a work unit may result in inconsistencies between the VSAM data, that was restored to the original version, and the change consumer.

The ATYLTRAN program, which is supplied with the OracleAS CDC Adapter for VSAM provides complete control over the transactional boundaries of captured changes. ATYLTRAN should be called as a separate STEP when:

- The logical transaction is started
- The logical transaction is terminated using both COMMIT and ROLLBACK
- The logical transaction is delayed (and should be continued later in another JOB)
- The logical transaction continued in another JOB

ATYLTRAN receives the following parameters:

- The logical transaction operation:
 - BEGIN: Indicates a new logical transaction. If a logical transaction with the same name exists, the old transaction is terminated using ROLLBACK.
 - COMMIT
 - ROLLBACK: Terminates the logical transaction
 - CONTINUE: The default. Use this after each JOB that does not terminate the current logical transaction, and at the beginning of each JOB that continues a logical transaction initiated by another JOB.
- The logical transaction name:
 - By default, the BEGIN operation initiates single job logical transaction with the same name as the JOB. If the logical transaction is continued to another JOB, or the transaction name is changed, the transaction name must be provided explicitly with the BEGIN operation. The same name should be provided with the CONTINUE operation at the beginning of the other JOB to continue the transaction.
 - The transaction name can be up to 15 characters long.

C.5 Security

The OracleAS CDC Adapter for VSAM adapter connects to the MVS logstream with an authorization level of READ. The DFSFLGX0 user exit connects to the logstream with an authorization level of WRITE. To determine the proper security authorizations see the *MVS Auth Assm Services Reference ENF-IXG IBM* manual.

Notes:

To access a logstream in an application with a READ authorization level, set the READ access to RESOURCE (<logstream name>) in SAF class CLASS(LOGSTRM).

To update a logstream in a program with a WRITE authorization level, set the ALTER access to RESOURCE (<logstream name>) in SAF class CLASS(LOGSTRM).

Back-end Adapter Data Type Support

The OracleAS CDC Adapter for VSAM supports several data types that are used when defining metadata in Oracle Studio. The data types are mapped from the COBOL data types during the import procedure.

Note: The mapping of data types between the OracleAS CDC Adapter for VSAM and Oracle Application Server is performed internally by Oracle Connect.

D.1 Data Type Mapping

The COBOL data type `COMP`, in the table is an abbreviation for, and synonymous with, `COMPUTATIONAL`. Square brackets ([]) denote optional qualifiers for some COBOL compilers, which may not be allowed for other COBOL compilers.

Table D-1 Data Type Mapping: COBOL and Oracle Connect Back-end Adapter

COBOL Data Type	Oracle Connect Data Type
BINARY (with fractional data)	string
BINARY (without fractional data)	int
COMP (with fractional data)	string
COMP (without fractional data)	int
COMP-2	double
COMP-3	string
COMP-4 (with fractional data)	string
COMP-4 (without fractional data)	int
COMP-5 (with fractional data)	string
COMP-5 (without fractional data)	int
COMP-X (with fractional data)	string
COMP-X (without fractional data)	int
INDEX	int
[SIGN [IS]] LEADING	string
[SIGN [IS]] LEADING SEPARATE [CHARACTER]	string
NATIVE-2	int

Table D-1 (Cont.) Data Type Mapping: COBOL and Oracle Connect Back-end Adapter

COBOL Data Type	Oracle Connect Data Type
NATIVE-4	int
NATIVE-8	string
PACKED-DECIMAL	string
POINTER	int
[SIGN [IS]] TRAILING	string
[SIGN [IS]] TRAILING SEPARATE [CHARACTER]	string

Globalization Settings

The OracleAS CDC Adapter for VSAM provides the globalization support for the following languages:

- Arabic
- English (the default)
- French
- German
- Greek
- Hebrew
- Italian
- Japanese
- Korean
- Portuguses
- Simple Chinese
- Spanish
- Traditional Chinese
- Turkish

This appendix describes how to define the language support.

E.1 Defining the Language and Code Page

The language and code page parameters are accessed from the computer where Oracle Studio is installed.

Perform the following steps to define the required language and code page:

1. From the **Start** menu, select **Programs, Oracle**, and then select **Studio**.
2. In the Design perspective **Configuration** view, expand the **Machines** folder.
3. Expand the machine for which you want to set the language.
4. Expand the Bindings folder and right-click the **NAV** binding.
5. Select **Open**.
6. Expand the **Language Settings** and do the following:

- From the **Language** list, select the NLS supported language to use in this binding. Valid values are listed in the Language Name column of [NLS Language Codes](#) table.
- From the **Codepage** list, select the code page to use with this language. The code pages available are determined by the Language that is selected. If you have additional code pages available, you can manually enter them in this field.

Note: If you change the language, the code page also changes. Ensure that you want to use the selected code page with the language you selected.

If no code page is selected, the default code page for the selected language is used.

- From the **NLS string** list, select the NLS string for this language and code page. The NLS strings available are determined by the code page that is selected. If you have additional NLS strings available, you can manually enter them in this field.

The code page is used by a field with a data type defined as `nlsString`. This parameter is used for a field with a code page that is different than the computer's code page. This property includes values for the name of the code page and whether the character set reads from right to left (as in middle-eastern character sets).

For example, the following specifies a Japanese EUC 16-bit code page:

```
<misc nlsString="JA16EUC,false"/>
```

7. Save the change. New servers are used for the language selected.

The following table lists the code pages:

Table E-1 NLS Language Codes

Language Name	Language Code	Windows Default	ASCII Platforms (Default)	EBCDIC Platforms (Default)	Alternative Code pages (EBCDIC based unless noted otherwise)
English US	ENUS	Windows-1252	ISO-8859-15	IBM1140	IBM285, IBM500, IBM1148, IBM1047, ISO-8859-1 (ASCII based)
English UK	ENUK	Windows-1252	ISO-8859-15	IBM1146	IBM285, IBM037, IBM500, IBM1140, IBM1148, IBM1047, ISO-8859-1 (ASCII based)

Table E-1 (Cont.) NLS Language Codes

Language Name	Language Code	Windows Default	ASCII Platforms (Default)	EBCDIC Platforms (Default)	Alternative Code pages (EBCDIC based unless noted otherwise)
French	FRE	Windows-1252	ISO-8859-15	IBM1147	IBM297, IBM037, IBM500, IBM1140, IBM1148, IBM1047, ISO-8859-1 (ASCII based)
Latin International	LAT	Windows-1252	ISO-8859-15	IBM1148	IBM500, IBM037, IBM1140, IBM1047, ISO-8859-1 (ASCII based)
Spanish	SPA	Windows-1252	ISO-8859-15	IBM1145	IBM284, IBM037, IBM500, IBM1140, IBM1148, IBM1047, ISO-8859-1 (ASCII based)
German	GER	Windows-1252	ISO-8859-15	IBM1141	IBM273, IBM037, IBM500, IBM1140, IBM1148, IBM1047, ISO-8859-1 (ASCII based)
Portuguese	POR	Windows-1252	ISO-8859-15	IBM1140	IBM037, IBM500, IBM1148, IBM1047, ISO-8859-1 (ASCII based)
Italian	ITL	Windows-1252	ISO-8859-15	IBM1144	IBM280, IBM037, IBM500, IBM1140, IBM1148, IBM1047, ISO-8859-1 (ASCII based)
Greek	GRK	Windows-1253	ISO-8859-7	IBM875	-
Russian ¹	RUS	Windows-1251	ISO-8859-5	IBM1154	IBM1025

Table E-1 (Cont.) NLS Language Codes

Language Name	Language Code	Windows Default	ASCII Platforms (Default)	EBCDIC Platforms (Default)	Alternative Code pages (EBCDIC based unless noted otherwise)
Turkish ²	TUR	Windows-1254	ISO-8859-9	IBM1155	IBM1026
Hebrew	HEB	Windows-1255	ISO-8859-8	IBM424	IBM 862
Arabic	ARA	Windows-1256	ISO-8859-6	IBM420	
Japanese	JPN	SJIS	SJIS	IBM939	EUC-JP=EUC, VMS-JP
Chinese - Simplified	SCHI	GBK	GBK	IBM935	-
Chinese - Traditional	TCHI	BIG5	BIG5	IBM937	-
Korean	KOR	MS949	EUC-KR	IBM933	MS949

¹ Russian users who use ANSI 1251 Cyrillic as their Windows code page must edit the `RUS.TXT` file and compile it to `RUS.CP` using the `NAV_UTIL CODEPAGE`.

² To work with solutions in Oracle Studio, when using Turkish, add the `-nl en` switch to the Target path in the Oracle Studio shortcut properties. For example: `"C:\Program Files\Oracle\Studio1\studio.exe -nl en"`

F

Editing XML Files in Oracle Studio

In many cases you must manually edit the metadata to configure parts of a solution or composition. Metadata is created in XML format. You define aspects of a solution by changing the values of the elements and attributes of the XML files that belong to the solution. Oracle Studio provides a graphical interface where you can define the various aspects of a solution. This interface lets you make changes easily without having to manually edit the XML file.

F.1 Preparing to Edit XML Files in Oracle Studio

You can edit XML files for the following items in Oracle Studio:

- Machines
- Bindings.
- Daemons
- Users

When you open an XML file, a graphical representation of the file is opened in the editor. The editor displays the elements and attributes in the first column and their corresponding values in the second column. Each entry has an icon that indicates whether the entry is an element or an attribute. Click the **Source** tab to view the file in its native format. The following figure is an example of the editor's view of an XML file.

Figure F-1 XML Graphical Display

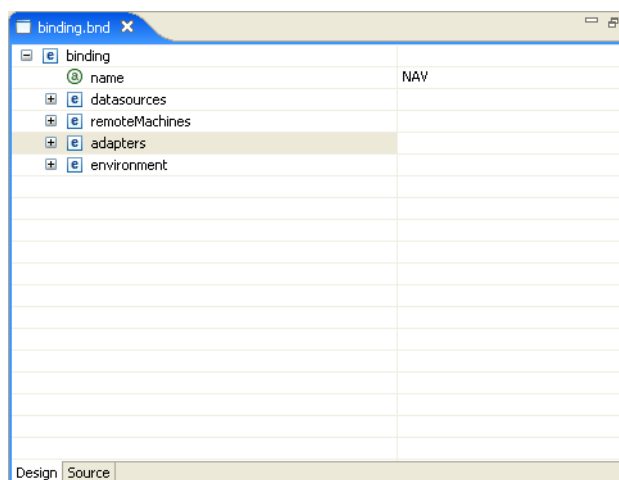

Do the following to edit an XML file in Oracle Studio

1. In the Design perspective, open the Navigator view.
2. In the Navigator view, find the item with the XML file to edit. This can be a machine, binding, daemon, or user.
3. Right-click the item and select **Open as XML**. A graphical list of the file's elements and attributes opens in the editor.
4. Find the element or attribute (property) to change.
5. Click in the right column next to the property you are changing and edit or add the value.
6. Save the file, then select it again in the Project Explorer and press F5 to refresh.
The XML file is updated automatically.

F.2 Making Changes to the XML File

You can also make the following changes to XML files in Oracle Studio:

- [Remove Objects](#)
- [Add DTD Information](#)
- [Edit Namespaces](#)
- [Add Elements and Attributes](#)
- [Replace an Element](#)

F.2.1 Remove Objects

You can delete an element, attribute, or other object from the XML file.

Do the following to remove an object

1. Right-click an object from the list in the editor.
2. Select **Remove**.

F.2.2 Add DTD Information

You can add DTD information to an element or attribute.

Do the following to add DTD Information

1. Right-click an element or attribute and select **Add DTD Information**. The Add DTD Information dialog box opens.

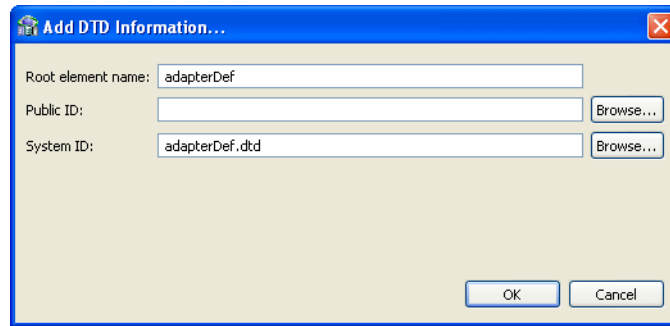
Figure F–2 Add DTD Information Dialog Box

2. Enter the information requested in the dialog box. The following table describes the Add DTD Information dialog box.

Table F–1 Add DTD Information

Field	Description
Root element name	The name of the XML root element.
Public ID	<p>The value in this field is the Public Identifier. It is used to associate the XML file (using an XML catalog entry) with a DTD file by providing a hint to the XML processor.</p> <p>Click Browse to select an XML catalog entry from a list. An XML Catalog entry contains two parts, a Key (which represents a DTD or XML schema) and a URI (which contains information about a DTD or XML schema's location). Select the catalog entry you want to associate with your XML file.</p>
System ID	<p>The value in this field is the DTD the XML file is associated with. You can change the DTD the file is associated with by editing this field. The XML processor tries to use the Public ID to locate the DTD, and if this fails, it uses the System ID to find it.</p> <p>Click Browse to select a system ID. You can this in two ways:</p> <ul style="list-style-type: none"> ■ Select the file from the workbench. In this case, update the with the import dialog box. ■ Select an XML catalog entry.

3. Save the file, then select it again in the Project Explorer and press F5 to refresh. The XML file is updated automatically.

F.2.3 Edit Namespaces

You can make changes to the namespaces associated with an element or attribute.

Do the following to edit namespaces

1. Right-click an element or attribute and select **Edit namespaces**. The Edit Schema Information dialog box opens.

Figure F–3 Edit Schema Information

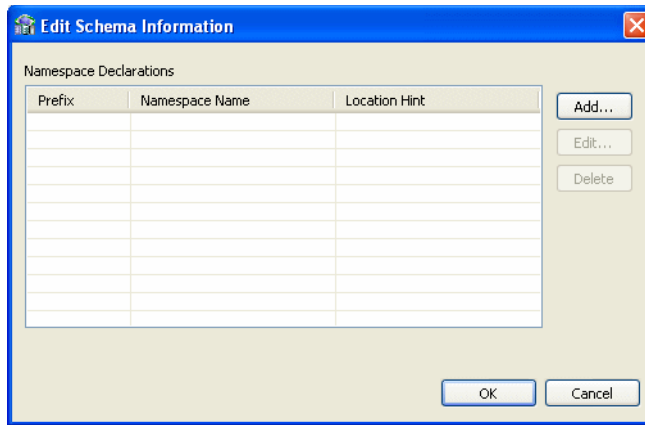

2. Click a button to make any changes to this information.

Do the following to add a new namespace

1. From the Schema Information dialog box, click **Add**.
2. The Add Namespace Definitions dialog box opens. Select one of the following:
 - **Select from registered namespaces.** This selection is available when the dialog box opens. Select from the list of registered namespaces and then click OK. If no registered namespaces are available, the list is empty.
 - **Specify new namespace.** Enter the information described in the following table:

Table F–2 New Namespace

Field	Description
Prefix	The prefix is added to all qualified elements and attributes in the XML file.
Namespace Name	The namespace of the XML file.
Location Hint	<p>The location of the XML schema of the XML file. An XML Catalog ID or a URI can be entered in this field.</p> <p>Click Browse to search for the schema you want You can this in two ways:</p> <ul style="list-style-type: none"> ■ Select the schema from the workbench. In this case, update the with the import dialog box. ■ Select an XML catalog entry. <p>The Namespace Name and Prefix fields are be filled with the appropriate values from the schema (you must leave the fields blank for this to occur).</p> <p>Note: If you are creating an XML file from an XML schema, you cannot change the Namespace Name or Location Hint values.</p>

To edit a namespace

1. From the Schema Information dialog box, click **Edit**.
2. Enter the information in the fields.

F.2.4 Add Elements and Attributes

You can add additional elements and attributes to the XML file.

Do the following to add Elements and Attributes

1. Right-click an element.
2. Select one of the following:
 - **Add Attribute** to add an attribute under the selected element.
 - **Add Child** to add another element under the selected element
 - **Add Before** to add another element above the selected element
 - **Add After** to add another element below the selected element
3. Provide a name for the element or attribute if required. You may also select the element from a submenu. The element or attribute is added to the file.
4. Save the file, then select it again in the Project Explorer and press F5 to refresh.
The XML file is updated automatically.

F.2.5 Replace an Element

You can replace an element with another legal element.

Do the following to replace an element

1. Right-click an element from the list in the editor.
2. Select **Replace with**.
3. Select an element from the submenu. Only legal elements are available.
4. The original element is replaced with the selected element.

A

ACX trace parameter, 7-7
adapter inbound configuration, 3-1
add timestamp to traced events parameter, 7-7
Arithmetic fixed precision parameter, 7-12

B

binary XML log level parameter, 7-7
binding file
 configuration, 3-4

C

cache
 maximum queries, 7-11
cache buffer size parameter, 7-8
CDC
 stream positions table, 3-1
CDC adapter
 connection factory, 3-2
CDC stream positions table, 3-1
code page parameter, 7-9
COM maximum XML size in memory
 parameter, 7-14
COM maximum XML size parameter, 7-14
COM XML transport buffer parameter, 7-14
commit on destroy, 7-13
configuring the binding file, 3-4
connection factory, 3-2
continuous query
 prefix, 7-11
 retry interval, 7-11
 timeout, 7-11
continuous query prefix parameter, 7-11
continuous query retry interval parameter, 7-11
continuous query timeout parameter, 7-11
creating JCA configuration files
 JCA configuration files
 creating, 3-3

D

daemon
 logging, B-3
 security, B-5

server modes, 7-2
shutting down, 6-7
starting, 6-7
timeout, 6-12
data sources, disabling caching, 7-10
data types
 atomic metadata, D-1
 NLS string parameter, 7-9
debug parameters
 ACX trace, 7-7
 add timestamp to traced events, 7-7
 environment, 7-7
 GDB trace, 7-7
 general trace, 7-7
 lbinary XML log level, 7-7
 log file, 7-7
 optimizer trace, 7-8
 query processor trace, 7-7
 query warnings, 7-7
 trace directory, 7-7
 Transaction extended logging, 7-8
disable 2PC, 7-13
disable command reuse parameter, 7-10
disable compilation cache parameter, 7-11
disable DS property cache parameter, 7-10
disable insert parameterization parameter, 7-10
disable metadata caching parameter, 7-10
disable query parameterization parameter, 7-10
disable row mark fail fetch parameter, 7-10
disable SQS cache parameter, 7-12
disable threads parameter, 7-10
disabling
 parameterization of constants, 7-10
 parameterization of queries, 7-10
dsm maximum buffer size parameter, 7-13
dsm middle buffer size parameter, 7-14
dsmMaxSortBufferSize parameter, 7-14

E

environment parameters
 ACX trace, 7-7
 add timestamp to traced events, 7-7
 Arithmetic fixed precision, 7-12
 cache buffer size, 7-8
 code page, 7-9

- COM maximum XML size, 7-14
- COM maximum XML size in memory, 7-14
- COM XML transport buffer, 7-14
- commit on destroy, 7-13
- continuous query prefix, 7-11
- continuous query retry interval, 7-11
- continuous query timeout, 7-11
- debug, 7-7
- disable 2PC, 7-13
- disable command reuse, 7-10
- disable compilation cache, 7-11
- disable DS property cache, 7-10
- disable insert parameterization, 7-10
- disable metadata caching, 7-10
- disable query parameterization, 7-10
- disable row mark fail fetch, 7-10
- disable SQS cache, 7-12
- disable threads, 7-10
- dsm maximum buffer size, 7-13
- dsm maximum sort buffer Size, 7-14
- dsm middle buffer size, 7-14
- expose XML fields, 7-12
- file close on transaction, 7-14
- file pool size, 7-14
- file pool size per file, 7-14
- first tree extensions, 7-11
- GDB trace, 7-7
 - general, 7-8
 - general trace, 7-7
- hash buffer size, 7-14
- hash enable RO, 7-14
- hash max open files, 7-14
- hash primary event size, 7-14
- hash secondary event size, 7-14
- ignore segment bind failure, 7-11
- insert from select commit rate, 7-12
- language, 7-8, 7-9
- log file, 7-7
- maximum columns in parsing, 7-11
- Maximum segmented database thread, 7-11
- maximum SQL cache, 7-11
- minimum number of parameters allocated, 7-11
- modeling, 7-9
- nav utility editor, 7-8
- NLS string, 7-9
- ODBC, 7-9
- OLEDDB, 7-9
- optimistic for updates, 7-11
- optimizer, 7-9
 - optimizer goal, 7-9
 - optimizer trace, 7-8
- parallel processing, 7-10
- parser depth, 7-12
- procedures cache size, 7-12
- prompt database user password, 7-11
- query processor, 7-10
- query processor trace, 7-7
- query warnings, 7-7
- recovery delay, 7-13
- Replace invalid XML characters, 7-15

- time limit, 7-13
- token size, 7-12
- trace directory, 7-7
- transaction conversions parameters, 7-13
- Transaction extended logging, 7-8
- transaction extended logging, 7-13
- transaction log file, 7-13
- transactions, 7-13
- ttemporary directory, 7-8
- tuning, 7-13
 - use alternate qualifier, 7-11
 - use global file pool, 7-14
 - use table filter expression, 7-11
 - user commit confirm table, 7-13
 - write empty string as null, 7-11
- XML, 7-14
 - XML date format parameter, 7-15
 - XML trim char column, 7-15
 - year 2000 policy, 7-8
- error log, binary XML log level parameter, 7-7
- error log, log file parameter, 7-7
- exact arithmetic, 7-12
- expose XML fields parameter, 7-12

F

- file close on transaction, 7-14
- file pool size, 7-14
- file pool size per file, 7-14
- first row optimization, optimizer goal parameter, 7-9
- first tree extensions parameter, 7-11
- floating point precision, 7-12

G

- GDB trace parameter, 7-7
- general parameters
 - cache buffer size, 7-8
 - environment, 7-8
 - nav utility editor, 7-8
 - temporary directory, 7-8
 - year 2000 policy, 7-8
- general trace parameter, 7-7

H

- hash buffer size, 7-14
- hash buffer size parameter, 7-14
- hash enable RO parameter, 7-14
- hash joins, 7-14
- hash max open files parameter, 7-14
- hash primary event size parameter, 7-14
- hash secondary event size parameter, 7-14

I

- ignore segment bind failure parameter, 7-11
- index cache
 - dsm middle buffer size parameter, 7-14
- insert from select commit rate parameter, 7-12

J

JCA configuration files, 3-3
 configuration, 3-3
joins
 hash buffer size parameter, 7-14
 hash max open files parameter, 7-14

L

language parameter, 7-9
language parameters
 code page, 7-9
 environment, 7-8, 7-9
 language, 7-9
 NLS string, 7-9
locking, optimistic, 7-11
log file parameter, 7-7
log files
 binary XML log level parameter, 7-7
 daemon options, B-3
 log file parameter, 7-7
logging
 daemon configurations, B-3
 optimizer strategy, 7-8

M

maximum columns in parsing parameter, 7-11
Maximum segmented database thread, 7-11
maximum SQL cache parameter, 7-11
memory
 dsm maximum buffer size parameter, 7-13
 dsm maximum sort buffer Size parameter, 7-14
 dsm middle buffer size parameter, 7-14
metadata
 atomic data types, D-1
 disabling retrieval from cache, 7-10
minimum number of parameters allocated
 parameter, 7-11
modeling environment parameters, 7-9

N

nav utility editor parameter, 7-8
nav utility editor, text editor, 7-8
NLS string parameter, 7-9

O

ODBC environment parameters, 7-9
OLEDB environment parameters, 7-9
optimistic for updates parameter, 7-11
optimizer
 optimizer goal parameter, 7-9
 trace directory parameter, 7-7
optimizer environment parameters, 7-9
optimizer goal parameter, 7-9
optimizer trace parameter, 7-8

P

parallel processing environment parameters, 7-10
parallel processing parameters
 disable threads, 7-10
parameterization of constants, disabling, 7-10
parameterization of queries, disabling, 7-10
parser depth parameter, 7-12
password, setting automatic prompt, 7-11
procedures cache size parameter, 7-12
prompt database user password parameter, 7-11

Q

queries
 disabling reuse, 7-10
 disabling saved compilation, 7-11
 enabling retrieval after failure, 7-10
 maximum cached in memory, 7-11
 maximum length of string, 7-12
 maximum size after compilation, 7-11
query optimizer
 logging strategy, 7-8
 optimizer goal parameter, 7-9
 trace directory parameter, 7-7
query processor
 environment parameters, 7-10
query processor parameters
 Arithmetic fixed precision, 7-12
 continuous query prefix, 7-11
 continuous query retry interval, 7-11
 continuous query timeout, 7-11
 disable command reuse, 7-10
 disable compilation cache, 7-11
 disable DS property cache, 7-10
 disable insert parameterization, 7-10
 disable metadata caching, 7-10
 disable query parameterization, 7-10
 disable row mark fail fetch, 7-10
 disable SQS cache, 7-12
 emptyStringIsNull parameter, 7-11
 expose XML fields, 7-12
 first tree extensions, 7-11
 ignore segment bind failure, 7-11
 insert from select commit rate, 7-12
 maximum columns in parsing, 7-11
 Maximum segmented database thread
 parameter, 7-11
 maximum SQL cache, 7-11
 minimum number of parameters allocated, 7-11
 optimistic for updates, 7-11
 parser depth, 7-12
 procedures cache size, 7-12
 prompt database user password, 7-11
 token size, 7-12
 use alternate qualifier, 7-11
 use table filter expression, 7-11
query processor trace parameter, 7-7
query warnings parameter, 7-7

R

recovery delay, 7-13
Replace invalid XML characters parameter, 7-15
rollback loops
 troubleshooting, 3-6
row optimization, optimizer goal parameter, 7-9

S

security
 daemon configurations, B-5
 setting automatic prompt, 7-11
segmented data sources, response upon failure, 7-11
servers
 configuring modes, 7-2
 reusable, 7-3
 Reuse limit daemon parameter, 7-3, B-13
setting up VSAM, 2-6
sort buffer, dsm maximum sort buffer size
 parameter, 7-14
staging area, 1-4
stored queries, maximum in cache memory, 7-12
stream positions table, 3-1

T

temporary directory parameter, 7-8
temporary files, 7-8
threading model, 7-11
time limit parameter, 7-13
timeout
 client idle, 6-12
 daemon, 6-12
token size parameter, 7-12
trace directory parameter, 7-7
trace information, logging, 7-7
transaction conversions parameters, 7-13
transaction extended logging, 7-13
Transaction extended logging parameter, 7-8
transaction log file, 7-13
transactions environment parameters, 7-13
transactions parameters
 commit on destroy, 7-13
 disable 2PC, 7-13
 recovery delay, 7-13
 time limit, 7-13
 transaction conversions parameters, 7-13
 transaction extended logging, 7-13
 transaction log file, 7-13
 user commit confirm table, 7-13
tuning parameters
 dsm maximum buffer size, 7-13
 dsm maximum sort buffer size, 7-14
 dsm middle buffer size, 7-14
 environment, 7-13
 file close on transaction, 7-14
 file pool size, 7-14
 file pool size per file, 7-14
 hash buffer size, 7-14
 hash enable RO, 7-14

hash max open files, 7-14
hash primary event size, 7-14
hash secondary event size, 7-14
use global file pool, 7-14

U

use alternate qualifier parameter, 7-11
use global file pool, 7-14
use table filter expression parameter, 7-11
user commit confirm table, 7-13

V

VSAM, setting up, 2-6

W

Weblogic
 deployment, 3-1
WebLogic deployment, 3-1
Workspace server mode, B-13
write empty string as null parameter, 7-11

X

XML
 environment parameters, 7-14
XML date format parameter, 7-15
XML parameters
 COM maximum XML size, 7-14
 COM maximum XML size in memory, 7-14
 COM XML transport buffer, 7-14
 Replace invalid XML characters, 7-15
 XML date format parameter, 7-15
 XML trim char column, 7-15
XML trim char column parameter, 7-15

Y

Y2K
 See year 2000 policy parameter
year 2000 policy parameter, 7-8