



BEA eLink OSI TP™

User Guide

Release 4.2
December 2002

Copyright

Copyright © 2002 BEA Systems, Inc. All Rights Reserved.

Restricted Rights Legend

This software and documentation is subject to and made available only pursuant to the terms of the BEA Systems License Agreement and may be used or copied only in accordance with the terms of that agreement. It is against the law to copy the software except as specifically allowed in the agreement. This document may not, in whole or in part, be copied, photocopied, reproduced, translated, or reduced to any electronic medium or machine readable form without prior consent, in writing, from BEA Systems, Inc.

Use, duplication or disclosure by the U.S. Government is subject to restrictions set forth in the BEA Systems License Agreement and in subparagraph (c)(1) of the Commercial Computer Software-Restricted Rights Clause at FAR 52.227-19; subparagraph (c)(1)(ii) of the Rights in Technical Data and Computer Software clause at DFARS 252.227-7013, subparagraph (d) of the Commercial Computer Software--Licensing clause at NASA FAR supplement 16-52.227-86; or their equivalent.

Information in this document is subject to change without notice and does not represent a commitment on the part of BEA Systems. THE SOFTWARE AND DOCUMENTATION ARE PROVIDED "AS IS" WITHOUT WARRANTY OF ANY KIND INCLUDING WITHOUT LIMITATION, ANY WARRANTY OF MERCHANTABILITY OR FITNESS FOR A PARTICULAR PURPOSE. FURTHER, BEA Systems DOES NOT WARRANT, GUARANTEE, OR MAKE ANY REPRESENTATIONS REGARDING THE USE, OR THE RESULTS OF THE USE, OF THE SOFTWARE OR WRITTEN MATERIAL IN TERMS OF CORRECTNESS, ACCURACY, RELIABILITY, OR OTHERWISE.

Trademarks or Service Marks

BEA, Jolt, Tuxedo, and WebLogic are registered trademarks of BEA Systems, Inc. BEA Builder, BEA Campaign Manager for WebLogic, BEA eLink, BEA Manager, BEA WebLogic Commerce Server, BEA WebLogic Enterprise, BEA WebLogic Enterprise Platform, BEA WebLogic Express, BEA WebLogic Integration, BEA WebLogic Personalization Server, BEA WebLogic Platform, BEA WebLogic Portal, BEA WebLogic Server, BEA WebLogic Workshop and How Business Becomes E-Business are trademarks of BEA Systems, Inc.

All other trademarks are the property of their respective companies.

Contents

About This Document

What You Need to Know	-viii
e-docs Web Site	-viii
How to Print the Document	-viii
Related Information	-ix
BEA eLink OSI TP Documentation	-ix
BEA Tuxedo Information	-ix
Other Publications	-x
Customer Support	-x
SURETY Support Services	-x
Unisys Customer Support	-x
Reporting a Software Problem with a User Communication Form	-xii
VAR Customer Support	-xiii
Documentation Conventions	-xiii

1. Introducing BEA eLink OSI TP

BEA eLink OSI TP Overview	1-1
BEA eLink OSI TP Features	1-3
BEA Tuxedo and eLink OSI TP Architecture	1-4
Multiplexed Flow Control	1-7
OSI TP Software Overview	1-8
Benefits of OSI	1-8
OSI Reference Model	1-8
Transaction Processing Services	1-9
OSI TP Domains Components	1-10

2. Managing Transactions and Buffers

Transaction Management	2-1
Tightly-Coupled and Loosely-Coupled Transactions.....	2-2
Global Transactions Across Domains	2-6
Transaction Recovery	2-7
Buffer and Data Translation	2-8
Layout Conversion for Buffer Types.....	2-8
ASN.1 Encoding.....	2-9
Buffers and Records	2-9
Buffers Received from Local Programs	2-9
Records Received from Remote Programs.....	2-10
Managing Parameters for Buffer and Record Conversion	2-11
Parameters for Locally Originated Calls	2-12
Parameters for Remotely Originated Calls.....	2-15
Mapping Buffers to Records.....	2-18
Mapping Records to Buffers.....	2-20
Special Cases and Examples of Buffer Conversion	2-22
DMCONFIG Examples for Conversion to View32 and FML	2-24
XML Buffer Support	2-25

3. Understanding the DCONFIG File

Overview of the DCONFIG File.....	3-1
OSI TP Application Addresses Used in the DCONFIG File.....	3-2
Creating an Application Entity Title	3-3
DCONFIG File Format	3-4
DCONFIG File Sections	3-5
Sample Configuration File	3-6
DM_LOCAL_DOMAINS Section.....	3-11
DM_REMOTE_DOMAINS Section.....	3-14
DM_OSITPX Section.....	3-16
DM_ACCESS_CONTROL Section.....	3-22
DM_LOCAL_SERVICES Section.....	3-23
DM_REMOTE_SERVICES Section.....	3-26
DM_ROUTING Section.....	3-30
Methods for Modifying Configurations	3-33

4. Configuring BEA eLink OSI TP

Configuration Prerequisites	4-1
Setting Environment Variables.....	4-2
Defining Gateway Configurations.....	4-3
Defining eLink OSI TP Servers for BEA Tuxedo.....	4-4
Sample UBBCONFIG File.....	4-5
Example of a Multiple Gateway Configuration	4-7
Using the Tuxedo MP Model with the eLink OSI TP Gateway	4-12
Using eLink OSI TP as a Pass-Through to Other Tuxedo Systems	4-16
Setting up Security	4-20
Enabling Link Layer Security	4-21
Enabling Tuxedo Authentication.....	4-25
Implementing Native-A Encoding	4-30
Rules for Viewfile Character Types	4-32
Editing the DMCONFIG File.....	4-34
Steps for Modifying the DMCONFIG File Parameters	4-35
Processing a Configuration File with the dmloadcf Utility.....	4-41
Invoking the dmloadcf Utility	4-42
How the dmloadcf Utility Works	4-43
Tuning OSI TP-Specific Tables with the TAILOR File	4-44
Enabling Automatic Suspension of Remote Services	4-49

5. Using the OSI TP Administration Utility

About the osiadmin Processor.....	5-1
Initiating osiadmin.....	5-2
Initiating osiadmin in Interactive Mode	5-2
Initiating osiadmin in Script Mode.....	5-3
What Happens When You Execute an osiadmin Command?	5-4
Using osiadmin Commands.....	5-4
Getting Help for osiadmin Commands.....	5-5
osiadmin Commands.....	5-5

A. Utilities Reference

DMADM	A-1
dmadmin.....	A-2

GWADM	A-22
-------------	------

B. Manually Upgrading BEA eLink OSI TP to Version 4.2

Upgrading From eLink OSI TP Version 1.3	B-1
Step 1 - Backup Existing Configuration Files	B-2
Step 2 - Modify Parameters in the DMCONFIG File	B-2
Upgrading From eLink OSI TP Version 4.0	B-4

Index

About This Document

BEA eLink™ OSI TP (hereafter referred to as eLink OSI TP) is a gateway connectivity product that enables application programs on BEA Tuxedo® systems to perform various transactional and non-transactional tasks with application programs that reside on different kinds of computers.

This document covers the following topics:

- [“Introducing BEA eLink OSI TP”](#) describes the BEA eLink platform and BEA eLink OSI TP product.
- [“Managing Transactions and Buffers”](#) provides an overview of how buffers and data translation are managed.
- [“Understanding the DMCONFIG File”](#) describes the DMCONFIG file sections and parameters.
- [“Configuring BEA eLink OSI TP”](#) provides procedures for configuring the BEA eLink OSI TP product.
- [“Using the OSI TP Administration Utility”](#) provides procedures for using the `osiadmin` utility.
- [“Utilities Reference”](#) provides a list of commonly used utilities and explains how they are used.
- [“Manually Upgrading BEA eLink OSI TP to Version 4.2”](#) describes the procedure for upgrading your DMCONFIG file manually.
- [“Index”](#)

What You Need to Know

This document is intended for system administrators who will administer the eLink OSI TP software.

e-docs Web Site

BEA Tuxedo product documentation is available on the BEA corporate Web site. From the BEA Home page, click on Product Documentation or go directly to the “e-docs” Product Documentation page at <http://edocs.bea.com>.

How to Print the Document

A PDF version of this document is available on the OSI TP documentation Home page on the e-docs Web site (and also on the installation CD). You can open the PDF in Adobe Acrobat Reader and print the entire document (or a portion of it) in book format. To access the PDFs, open the OSI TP documentation Home page, click the PDF files button and select the document you want to print.

If you do not have the Adobe Acrobat Reader, you can get it for free from the Adobe Web site at <http://www.adobe.com/>.

Related Information

Various other related documentation is available to help you understand the eLink OSI TP product, Tuxedo product, and OLTP technology. Refer to the documentation sources listed in the following sections for additional information about BEA products and OLTP technology.

BEA eLink OSI TP Documentation

The eLink OSI TP documentation consists of the following items:

- *BEA eLink OSI TP Installation Guide*
- *BEA eLink OSI TP User Guide*
- *BEA eLink OSI TP Release Notes*

BEA Tuxedo Information

Information about the BEA Tuxedo Version 8.0 product is available on the BEA Tuxedo Online Documentation Web site.

Tuxedo Release 8.0

The following BEA Tuxedo Release 8.0 information is available at <http://edocs.bea.com/tuxedo/tux80/index.htm>:

- *Installation*
- *Getting Started*
- *Administration*
- *Programming*
- *Platforms*

-
- *Reference*
 - *Messages*

Other Publications

For more information about OLTP technology, refer to the following books:

- *The Tuxedo System* (Andrade, Carges, Dwyer, Felts)
- *Tuxedo: An Open Approach to OLTP* (Primatesta)
- *Building Client/Server Applications Using Tuxedo* (Hall)

Customer Support

The BEA eLink OSI TP product is jointly developed by BEA Systems, Inc. and Unisys Corporation. Support services and contacts are described in the following sections.

SURETY Support Services

A SURETY service agreement gives you easy access to Unisys Support Online or Unisys Client Support Centers. These services are described below.

Unisys Customer Support

Unisys customer support gives clients easy access, on the World Wide Web or by telephone, to these service options:

- Support Online
- Client Support Centers

- Tech Advantage

Clients with valid support agreements can visit an electronic database of reported problems and solutions. They can also use e-mail or telephone to contact our product specialists with technical questions. Clients are eligible to receive updates to a product when critical problems have been fixed.

Support Online

Unisys has a World Wide Web site available to customers who have support agreements. If you have any questions or problems with a Unisys product, your first source of information is Support Online, an online technical resource available through the World Wide Web at <http://www.support.unisys.com>.

This technical resource is available 24 hours a day, 7 days a week. It offers a wealth of information about Unisys hardware and software systems. Take some time to explore Support Online and discover the services available to you.

Client Support Centers

Unisys clients with valid support agreements can also access Client Support Centers. If you have unresolved questions or problems concerning Unisys product installation or operation (after referring to the documentation or your system administrator), call the appropriate Client Support Center:

Within the continental United States or Canada, call one of the following toll-free numbers:

1-800-328-0440 (prompt 4) - United States

1-800-387-6181 - Canada

1-800-361-8097 - French Canada

Outside the continental United States, obtain a support center telephone number from your local Unisys customer support representative.

To expedite your request, please have the following information ready before contacting Unisys.

- The name of the hardware (for example, SUN, HP, AIX, UNIXWARE or PC)

-
- The name and release level of the operating environment (for example Solaris 8, or Windows 2000)
 - The BEA Tuxedo release level, the BEA eLink OSI TP release level, and the patch levels of both.

Tech Advantage

In addition, Unisys Client Support Centers offer Tech Advantage, a full complement of technical service packages that provide you with cost-effective, fast-cycle support. Tech Advantage services can help you solve your most difficult problems or maximize the effectiveness of your system, regardless of your product choice.

Here are some ways to put Tech Advantage to work for you:

- **System Generation**-Assist in generating or installing system software upgrades and enhancements.
- **Operating System Migration**-Plan and optimize your system migrations.
- **Performance Review**-Evaluate existing systems and networks and provide tuning recommendations.
- **Communications Systems Enhancements**-Assist in configuring, generating, and installing communications systems.
- **Database Management Consulting**-Confirm that systems and database backup procedures are optimized to promote data recovery.

For more information on Tech Advantage, visit the Support Online Web page and follow the link to Tech Advantage or call your Client Support Center.

Reporting a Software Problem with a User Communication Form

A customer representative may provide instructions or solutions from the Client Support Center database. If this help is insufficient, provide your representative with a full description of the problem, including any relevant error messages, and, if possible, a full description of the function you were attempting and your actions immediately

prior to the error. The representative will then submit an electronic User Communication Form (UCF) to Unisys on your behalf, and give you the following information:

- A UCF registration number
- Instructions for submitting supporting materials, such as traces and dumps

VAR Customer Support

All clients of Unisys resellers should contact their Value Added Resellers (VARs) for support access details.

Documentation Conventions

The following documentation conventions are used throughout this document.

Convention	Item
blue text	Indicates a hypertext link in PDF or HTML
<i>italics</i>	Indicates emphasis or book titles or variables.
"string with quotes"	Indicates a string entry that requires quote marks.
UPPERCASE TEXT	Indicates generic file names, device names, environment variables, and logical operators. <i>Examples:</i> LPT1 SIGNON OR

Convention	Item
monospace text	<p>Indicates code samples, commands and their options, data structures and their members, data types, directories, and file names and their extensions. Monospace text also indicates text that you must enter from the keyboard.</p> <p><i>Examples:</i></p> <pre>#include <iostream.h> void main () the pointer psz chmod u+w * \tux\data\ap .doc tux.doc BITMAP float</pre>
monospace boldface text	<p>Identifies significant words in code.</p> <p><i>Example:</i></p> <pre>void xa_commit ()</pre>
{ }	<p>Indicates a set of choices in a syntax line. The braces themselves should never be typed.</p>
[]	<p>Indicates optional items in a syntax line. The brackets themselves should never be typed.</p> <p><i>Example:</i></p> <pre>buildclient [-v] [-o name] [-f file-list]... [-l file-list]...</pre>
	<p>Separates mutually exclusive choices in a syntax line. The symbol itself should never be typed.</p>
...	<p>Indicates one of the following in a command line:</p> <ul style="list-style-type: none"> ■ That an argument can be repeated several times in a command line ■ That the statement omits additional optional arguments ■ That you can enter additional parameters, values, or other information <p>The ellipsis itself should never be typed.</p> <p><i>Example:</i></p> <pre>buildclient [-v] [-o name] [-f file-list]... [-l file-list]...</pre>

Convention	Item
.	Indicates the omission of items from a code example or from a syntax line.
.	The vertical ellipsis itself should never be typed.
.	



1 Introducing BEA eLink OSI TP

This section covers the following topics:

- [“BEA eLink OSI TP Overview”](#)
- [“BEA eLink OSI TP Features”](#)
- [“BEA Tuxedo and eLink OSI TP Architecture”](#)
- [“OSI TP Software Overview”](#)
- [“OSI TP Domains Components”](#)

BEA eLink OSI TP Overview

BEA eLink OSI TP is a gateway connectivity product that makes it possible for OLTP application programs on BEA Tuxedo systems to perform global transactions and various non-transactional tasks with application programs in the following environments:

- Other BEA Tuxedo applications. An application (or administrative domain) is a single computer or network of computers that share a single BEA Tuxedo configuration.
- Other systems that implement the Open Group XATMI standard interface and OSI-TP standard protocols. These include Unisys A Series enterprise servers or

Unisys OS 2200 enterprise servers that support Open/OLTP software and OSI-TP, Microsoft MTS through Unisys OpenTI, and ICL Open VME.

Figure 1-1 BEA eLink OSI TP Communicating with an OSI TP Partner

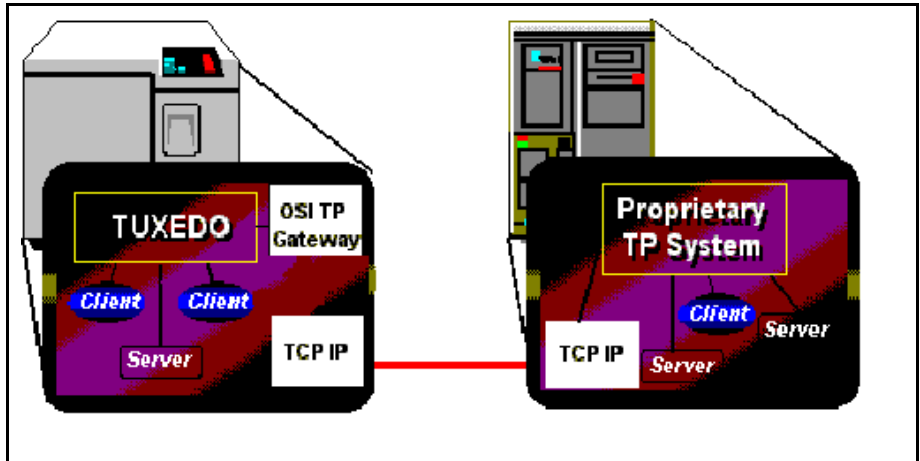

BEA eLink OSI TP implements the OSI-TP standard, a set of protocols that is used to:

- Establish and support dialogs between application programs on different computers.
- Facilitate commitment and rollback of global transactions that span multiple computers.

The Open Group XATMI standard is an interface that application programs use to communicate with other application programs both inside and outside of global transactions. It supports conversational and request/reply communication styles and is fully implemented by eLink OSI TP.

Data mapping and transformation between the BEA Tuxedo and mainframe environments is easily automated in BEA Tuxedo-based applications with the BEA Tuxedo typed buffer mechanism. This mechanism allows system administrators to predefine how data should be conveyed to the remote application. Application programmers do not need to be aware of this translation; they can simply continue using the buffer types defined for the local application. The eLink OSI TP software is designed to provide transparent access to remote services that reside outside a BEA Tuxedo application. In addition, eLink OSI TP provides remote application programs with access to local services.

Figure 1-2 BEA eLink OSI TP Sample Environment

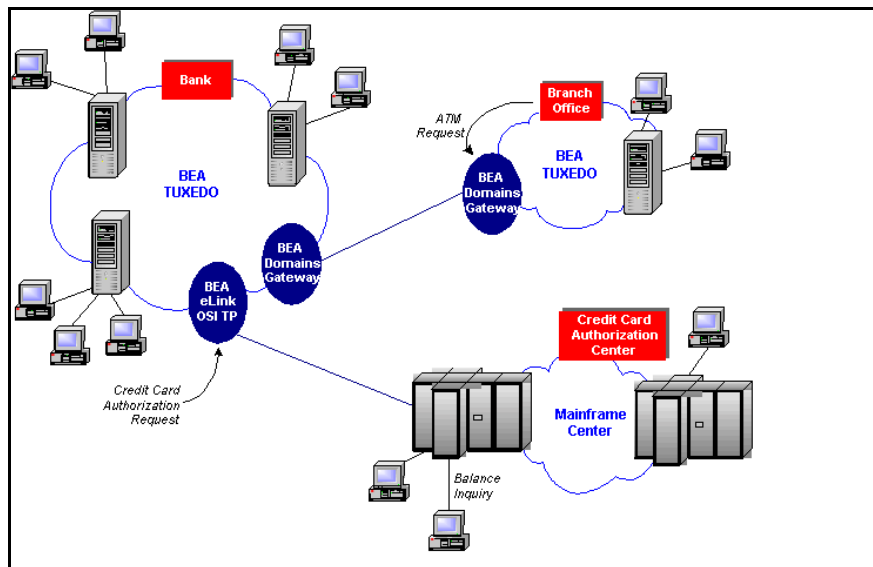

BEA eLink OSI TP Features

The eLink OSI TP product supports the following features:

- Tightly-coupled and loosely-coupled transaction processing
- Full array of buffer translation options
- Optional *AUTOPREPARE* feature that allows requests to remote services to be automatically prepared
- Synchronous and asynchronous service requests and replies initiated from either the BEA Tuxedo or mainframe environments
- Conversational service requests and replies initiated from either the BEA Tuxedo or the mainframe environments
- Global Transactions with OSI TP partners

- Event monitoring and reporting
- Dynamic configuration support
- ASN.1 based data conversion
- Link-layer security and global user authentication to participating remote domains
- Multiplexed OSI TP connections with built-in keep alive functionality and enhanced flow control mechanism
- Multiple simultaneous request/response sessions and conversations
- Connections to remote domains
- Transaction recovery for failures occurring during the second phase of commitment
- Automatic suspension of remote services that have failed (through Tuxedo)
- NATIVE A Series COBOL Copybook Data Conversion
- XML Buffer Support

BEA Tuxedo and eLink OSI TP Architecture

A BEA Tuxedo application consists of client and server programs that operate across a network of BEA Tuxedo systems. Any client program can request services that are offered by any server program running on any computer in the application. The location of server programs is kept transparent because remote services are mapped to servers in a section of the configuration file. The eLink OSI TP architecture comprises two distinct internal components, `nw-bea` and `nw-unisys`. These two internal components extend the transparent access of the BEA Tuxedo system by sending requests to and receiving requests from remote systems through OSI TP and supporting network software. [Figure 1-3](#) shows how this transparent access works.

Figure 1-3 Routing Service Calls through BEA eLink OSI TP

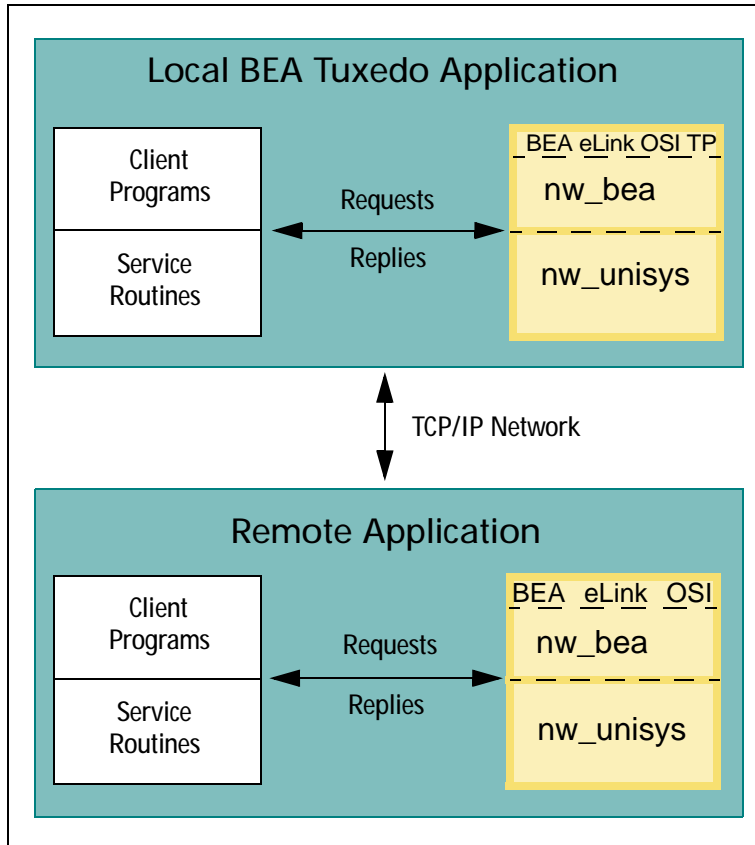

- When local BEA Tuxedo client programs send requests to remote systems, eLink OSI TP transforms those requests into OSI TP messages. When remote systems respond, eLink OSI TP transforms associated OSI TP messages into replies that local client programs can process.
- When remote client programs send OSI TP messages to local applications, eLink OSI TP transforms those messages into requests that local BEA Tuxedo service routines can process. When local service routines send replies, eLink OSI TP transforms those replies into OSI TP messages.
- When commitment protocol is sent for global transactions, eLink OSI TP transforms the protocol and manages the transaction commitment.

The eLink OSI TP software is implemented as an ordinary BEA Tuxedo server group that accepts standard BEA Tuxedo service requests and returns standard replies. The eLink OSI TP server group consists of the following components:

- A server program that includes the TMS service
- An administrative server

One eLink OSI TP server group acts as a gateway to multiple remote systems. The eLink connection manager can either:

- Use multiple communications targets

If you use multiple communication targets, you have a unique OSI TP endpoint called an *association*. When using unique communications targets, there is one association or connection to the remote system for each call to the remote system. After the call is complete, that association is reused by subsequent calls. There is a connection to the remote system for each simultaneous call made to the remote system. The association is released after a pre-set timer expires, turning unused resources back to the system. This pre-set timer is controlled by parameters specified in the OSI TP tailor file. Refer to [“Tuning OSI TP-Specific Tables with the TAILOR File”](#) for more information.

- Configure eLink OSI TP to multiplex all communications per remote system

To multiplex all communications per remote system, you must have the version of eLink OSI TP that has this feature and your remote system must support OSI TP multiplexing. When using multiplexing, all data is streamed or collected and sent to the remote system. Data messages are sent and received in an efficient manner increasing scalability and performance. The XATMI data representation is still used, but the representation of internal OSI TP data exchanges is optimized.

Some remote targets, such as remote BEA Tuxedo applications, also support BEA eLink OSI TP. In this situation, eLink OSI TP servers associated with the local gateway communicate with eLink OSI TP servers associated with remote gateways through OSI TP.

Other products such as remote Unisys A Series Open/OLTP systems, Unisys OS2200 systems, Unisys OpenTI for MTS interoperability, and ICL TPMS for Open VME provide analogous functionality with which local eLink OSI TP servers can interact.

The eLink OSI TP software maintains its own control information in shared memory, in much the same way that BEA Tuxedo software itself maintains the Bulletin Board. Although eLink OSI TP accesses the BEA Tuxedo Bulletin Board, BEA Tuxedo does not access eLink OSI TP control information.

To a remote system that supports the Open Group XATMI standard (more specifically, an XATMI application service element), the eLink OSI TP server group appears as a communications resource manager (CRM).

Multiplexed Flow Control

When the multiplexed protocol is used, flow control is implemented in the following manner. When the amount of data buffered to a particular RDOM exceeds the threshold defined by `StartFlowControlThreshold`, GWOSITP sends a request to Tuxedo to unadvertise all services associated with the particular LDOM and RDOM involved. This allows all call and connect requests already accepted by GWOSITP to complete normally without being aborted. If one or more redundant RDOMs are configured with the same services advertised, then Tuxedo will automatically route new requests to these other RDOMs. If no other RDOM advertises the services, new `tpcall` or `tpconnect` requests will get a `TPENOENT` error.

When the amount of data buffered to a particular RDOM falls below the threshold defined by `StopFlowControlThreshold`, GWOSITP sends a request to Tuxedo to advertise all services associated with the LDOM and RDOM involved.

Because of the lag time between detecting flow control and unadvertising the services, it is possible for the amount of buffered data to exceed the value of `StartFlowControlThreshold` by a significant margin. Therefore, care should be taken when configuring `StartFlowControlThreshold` with a large value.

Note: For more information about the `StartFlowControlThreshold` and `StopFlowControlThreshold` parameters in the TAILOR file, refer to [“Tuning OSI TP-Specific Tables with the TAILOR File.”](#)

OSI TP Software Overview

Open Systems Interconnection (OSI) is a computer network architecture developed by the International Organization for Standardization (ISO) in cooperation with other standards Organizations. OSI standards define protocols for communication between diverse computer systems in a network.

Benefits of OSI

By conforming to OSI standards, computer hardware and software vendors can enable applications on a local computer system to communicate with applications on remote computer systems that are manufactured by another vendor or have a different architecture from the local system.

OSI Reference Model

The OSI architecture is based upon a framework that divides the networking tasks and requirements into seven layers. The layers are groups of related functions or tasks, intended to make their interfaces and functions easier to understand.

Each layer contains entities that perform specific functions in the communication process. Entities throughout the network that are in the same layer and perform the same functions on different systems are called peer entities. They communicate with each other in a standard way. This is called protocol.

In the OSI Reference Model, peer entities cannot communicate directly. On the sending system, a layer entity uses peer protocols to attach a header containing routing and control information to the message being sent. It then passes this information down to the next layer. That layer adds its own header information and passes it to the next lower layer.

When the message reaches the receiving system, entities in each layer:

- Read and remove the information in the headers added by their peers on the sending system.

- Pass the remaining message up to the next layer.

The following figure illustrates the seven common protocol layers of the OSI Reference Model.

Figure 1-4 OSI Reference Model

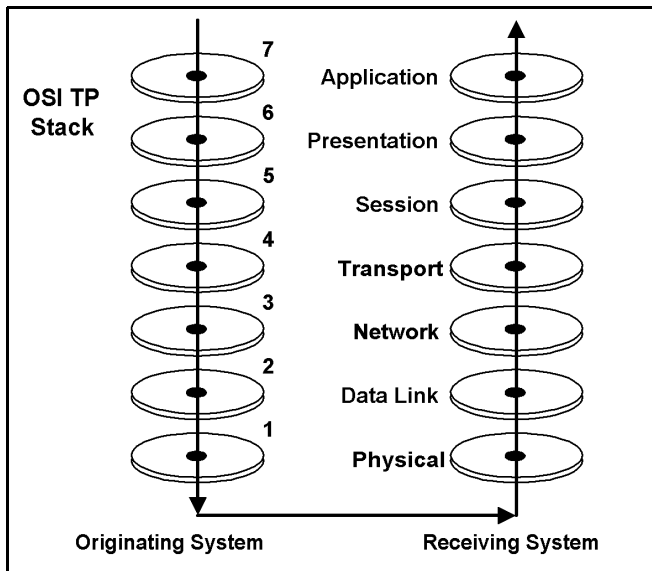

Transaction Processing Services

OSI TP works with Tuxedo to provide the following services:

- Marks the beginning of a distributed transaction.
- Coordinates the commitment and rollback of a distributed transaction.
- Performs automatic recovery of all communications paths in the event of a failure.

OSI TP Domains Components

The eLink OSI TP software and other eLink products act as gateways between BEA Tuxedo systems and other online transaction processing environments. Connections with remote systems are established by configuring eLink OSI TP as an ordinary BEA Tuxedo server group that identifies remote systems and available services.

The eLink OSI TP gateway is composed of several elements that can be configured to provide OSI TP solutions. For the most part, the OSI TP domain is much like the other domain gateways. It uses the DMADM and GWADM servers provided with BEA Tuxedo for administration.

The following diagram describes each component of the eLink OSI TP product.

Figure 1-5 Domain Components

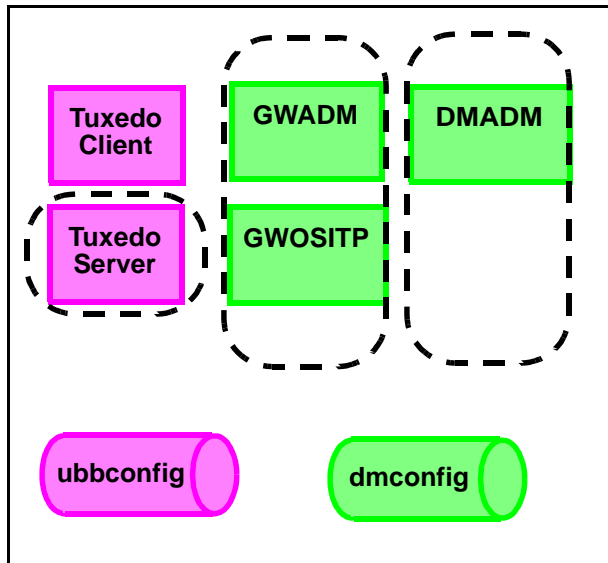

LEGEND:
DMADM = Domain Administration Server
GWADM = Gateway Administration Server
GWOSITP = Transactional/OSI TP Domains Instance

BEA eLink OSI TP uses the following administrative servers for domain and gateway configuration and administration:

- DMADM - Domain administration server
- GWADM - Gateway administration server
- GWOSITP - OSI TP Domain Gateway

Note: The gateway, GWOSITP, must be started **AFTER** the other servers.

Specific information on configuring the various sections of a domain are covered in the BEA Tuxedo document, *BEA Tuxedo /Domain Guide*.

1 *Introducing BEA eLink OSI TP*

2 Managing Transactions and Buffers

This section covers the following topics:

- [“Transaction Management”](#)
- [“Buffer and Data Translation”](#)
- [“Managing Parameters for Buffer and Record Conversion”](#)
- [“Mapping Buffers to Records”](#)
- [“Mapping Records to Buffers”](#)
- [“Special Cases and Examples of Buffer Conversion”](#)
- [“XML Buffer Support”](#)

Transaction Management

Transaction management provides coordination for the completion of transactions, whether the transaction is successful or not. Application programmers can request the execution of remote services within a transaction, or users at remote domains can request the execution of local services within a transaction. Domains transaction management coordinates the mapping of remote transactions to local transactions, and the sane termination (commitment or rollback) of these transactions.

In the BEA Tuxedo system, a transaction tree is a two-level tree where the root is the group coordinating a global transaction and the branches are other groups on other machines that are involved in the transaction. Each group performs its part of the global transaction independently from the parts done by other groups. Each group, therefore, implicitly defines a transaction branch. If this BEA Tuxedo transaction branch is controlled by the eLink OSI TP domain, it may contain multiple actual OSI TP transaction branches. The eLink OSI TP gateway controls the mapping between the single BEA Tuxedo transaction root and the many OSI TP transaction branches. The BEA Tuxedo system uses Transaction Manager Servers (TMS) to coordinate the completion of the global transaction and make sure each branch completes.

Domains transaction management can be summarized as follows:

- Gateways generate mappings from a BEA Tuxedo transaction to a network transaction. A new mapping is generated for each BEA Tuxedo transaction or for each incoming network transaction branch.
- Each instantiation handles its own representation of the network transaction tree. Instantiations observe the hierarchical nature of the inter-domain communication.

Tightly-Coupled and Loosely-Coupled Transactions

In the Open Group DTP Model, a Transaction Manager (TM) can construct transaction trees by defining either tightly-coupled or loosely-coupled relationships with a Resource Manager (RM). The coupling of the relationships are determined by the way the local service is defined in the `DMCONFIG` file.

A tightly-coupled relationship is one in which the same transaction identifier, `XID`, is used by all processes participating in the same global transaction and accessing the same RM. This relationship maximizes data sharing between processes; XA-compliant RMs expect to share locks for resources used by processes having the same `XID`.

The BEA Tuxedo system achieves the tightly-coupled relationship through the group concept; that is, work done by a group on behalf of a given global transaction belongs to the same transaction branch; all the processes are given the same `XID`. In a loosely-coupled relationship, the TM generates a transaction branch for each part of the work in support of the global transaction. The RM handles each transaction branch separately; there is no sharing of data or of locks between the transaction branches. Deadlocks between transaction branches can occur. A deadlock results in the rollback

of the global transaction. In the BEA Tuxedo system, when different groups participate in the same global transaction each group defines a transaction branch; this results in a loosely-coupled relationship. The eLink OSI TP instantiation is user configurable and can provide a tightly-coupled integration that solves this deadlock problem by minimizing the number of transaction branches required in the interoperation between two domains.

Following are diagrams showing loosely-coupled and tightly-coupled integrations and an explanation of each diagram.

Figure 2-1 Example of a Tightly-Coupled Integration

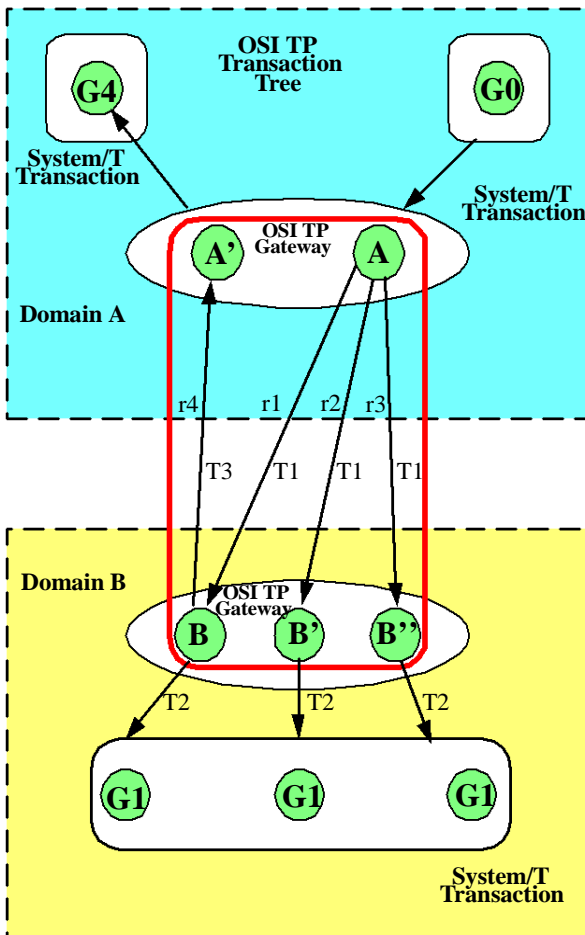

The transaction tree for the tightly-coupled integration shown in [Figure 2-1](#) eliminates the probability for intra-transaction deadlock by minimizing the number of transaction branches required in the interoperation between two domains. Application A makes three requests (r1, r2 and r3) to a remote Domain B. OSI TP sends all three requests mapped to the same OSI TP transaction, T1. On Domain B, the eLink OSI TP gateway checks the `COUPLING` flag for the remote service and discovers that for service B the `COUPLING=TIGHT`. In this case all requests for service B belong to the same BEA Tuxedo system transaction. Each request for service B is added to the previous requests and all will have the same BEA Tuxedo `XID` indicated by T2. Resources in group G1 will not be isolated and changes made by any instantiation of service B for this transaction will be “seen” by the others. Request r4 is mapped to identifier T2 on Domain B, but the Tuxedo domain generates a new branch in its transaction tree (r4: B to A'). This is a new transaction branch on Domain A, and therefore, the gateway generates a new mapping T3, to a new BEA Tuxedo system transaction. The gateway group on Domain A also coordinates group G4, so the hierarchical nature of inter-domain communication is fully enforced with this mapping; group G4 cannot commit before group G1.

Figure 2-2 Example of a Loosely-Coupled Integration

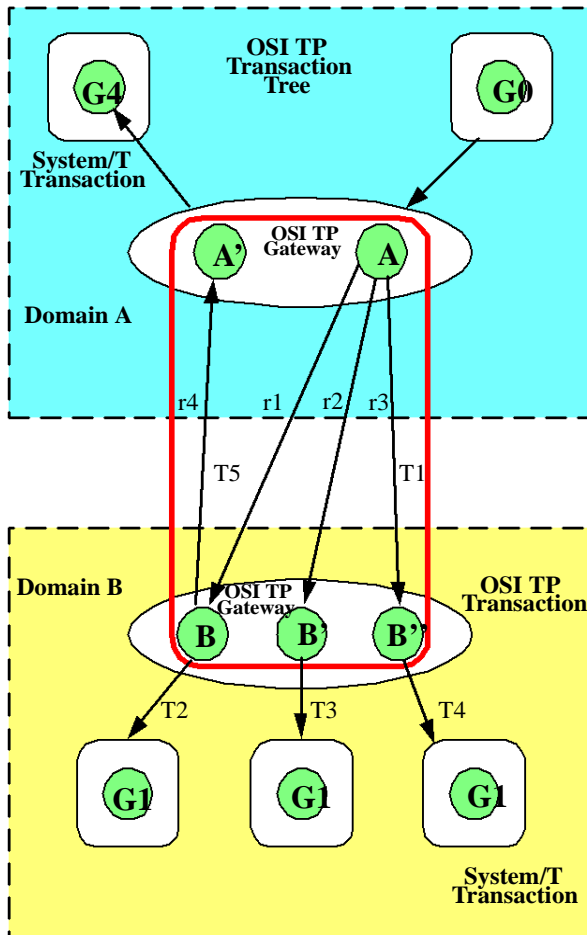

The transaction tree for the loosely-coupled integration shown in [Figure 2-2](#) shows group G0 in Domain A coordinating the global transaction started by the client. In this case application A sends three requests (r1, r2, and r3) to a remote Domain B. Like the tightly-coupled case, all three branches are represented by OSI TP transaction T1. On Domain B, the eLink OSI TP gateway checks the `COUPLING` flag for the remote service and sees that service B is `COUPLING=LOOSE`. In this case, the eLink OSI TP gateway generates three BEA Tuxedo system transactions: T2, T3 and T4. Any changes made to G1 are isolated. For example, any changes made by service B can not be “seen” by service B'. When B calls back the A', a new transaction, T5, is generated.

Global Transactions Across Domains

A global transaction in a single BEA Tuxedo application follows a two-level transaction tree, but a global transaction across domains follows a more complex transaction tree. There are two reasons for this:

- A transaction across domains may involve more domains than can be known from the root domain (where the transaction is controlled), so the structure of the transaction tree cannot be fully known.
- The root domain of a transaction across domains may not be directly connected to all domains in the transaction as would be required for a two-level transaction tree.

The commitment protocol across domains must be hierarchical to handle the complex transaction tree structure. For example, a loop-back service request is made from one domain (Domain A) to another domain (Domain B) and then comes back to be processed in the original domain. The service in Domain B requests another service in Domain A. The transaction tree has two branches at the network level: a branch b1 from A to B and a branch b2 from B to A. Domain A cannot commit the work done on branch b2 before receiving commit instructions from B.

The eLink OSI TP instantiation optimizes `GTRID` mapping by optionally implementing a tightly-coupled relationship. In eLink OSI TP, service requests issued on behalf of the same global transaction are mapped to the same network transaction branch. Therefore, incoming service requests can be mapped to a single BEA Tuxedo transaction. However, the hierarchical structure of inter-domain communication and the inter-domain transaction tree must still be maintained. See [Figure 2-1](#) for an example of a tightly-coupled relationship.

The optimization that eLink OSI TP introduces applies only to a single domain. When two or more domains are involved in the transaction, the network transaction tree contains at least one branch per domain interaction. Therefore, across domains, the network transaction tree remains loosely-coupled. There will be as many branches as there are domains involved in the transaction (even if all branches access the same resource manager instance). Domains gateway groups implement a loosely-coupled relationship because they generate different transaction branches for inter-domain transactions.

See [Figure 2-2](#) for an example of a loosely-coupled relationship. Notice that the gateway still must perform mappings between a BEA Tuxedo transaction and a network transaction, and that the hierarchical nature of the communication between

domains must be strictly enforced. [Figure 2-2](#) shows that requests r1, r2, and r3 are mapped to a single eLink OSI TP transaction branch. Therefore, on Domain B only one BEA Tuxedo transaction needs to be generated; request r4 is mapped to an identifier on Domain B, but eLink OSI TP generates a new branch in its transaction tree (r4: B to A'). This is a new transaction branch on Domain A, and therefore, the gateway generates a mapping to a new BEA Tuxedo transaction. The graph shows that gateway group GW on Domain A also coordinates group G4. Hence, the hierarchical nature of inter-domain communication is fully enforced with this mapping: group G4 cannot commit before group G1.

Transaction Recovery

OSI TP can recover an entire transaction of individual dialogues if one or more failures occur during the second phase of the two-phase commit process. Failures that occur before the second phase of commitment cause the transaction to roll back automatically. Three types of failure can occur after the second phase of commitment begins. For these types of failures, the following transaction recovery actions can occur:

Table 2-1 Transaction Recovery Actions for Failures

Type of Failure	Transaction Recovery Action
Communications Failure	eLink OSI TP automatically re-establishes communications so the transaction can be completed
Software Failure	eLink OSI TP maintains communications with the other hosts involved in the transactions until the application is restored. When the application is restored, OSI TP informs the application of the active transactions that need to be completed and the state of each transaction. The application must direct OSI TP to commit or roll back each transaction.
System Failure	The application informs eLink OSI TP of the active transactions that need to be completed and the state of each transaction from the secured data log. eLink OSI TP then establishes communications with the other hosts involved so that transactions can be completed.

Buffer and Data Translation

The eLink OSI TP software uses typed buffers to transmit and receive data. Full buffer translation is supported for the following buffer types:

- CARRAY
- X_OCTET

Note: Null X_OCTET buffers are *not* supported.

- FML and FML32
- STRING
- VIEW and VIEW32
- X_C_TYPE
- X_COMMON
- XML

The following sections introduce procedures that eLink OSI TP follows to process and convert data buffers.

Layout Conversion for Buffer Types

XATMI (X/Open Application Transaction Manager Interface) mappings to OSI TP are defined in the XATMI ASE (Application Service Element). BEA eLink OSI TP supports this combination. Interoperability using eLink OSI TP requires that remote systems support XATMI ASE. Therefore, Tuxedo-specific buffer types, such as `STRING`, `VIEW`, `FML`, and `CARRAY` may need to be converted into XATMI standard types. BEA eLink OSI TP Gateways perform these layout conversions implicitly.

ASN.1 Encoding

Abstract Syntax Notation 1 (ASN.1) is an international standard that provides a canonical representation to deal with data representation differences such as byte order, word length, and character sets. The local gateway (GWOSITP) encodes input from the local client program. It produces an ASN.1 encoded record that is sent to the remote service. When a reply is received, it is decoded before being returned to the client. Similarly, when remote requests for local services are received by the local gateway, they are decoded from the ASN.1 format. Replies are then encoded for return to the remote client.

Buffers and Records

The following terms are used to describe input and output data:

Buffer

Input or output data as it exists inside the local BEA Tuxedo region. This includes all the buffer types that BEA Tuxedo software supports—both BEA Tuxedo ATMI buffer types and X/Open XATMI buffer types.

Record

Input or output data as it exists outside the local BEA Tuxedo region on different kinds of Open/OLTP systems.

These terms make it easier to understand how eLink OSI TP handles input and output data.

Buffers Received from Local Programs

The eLink OSI TP gateway processes buffers from local programs in the following manner.

1. When eLink OSI TP receives a buffer from a local program, it automatically determines the buffer's type.

The eLink OSI TP product automatically “types” input buffers that local client programs send to remote services.

The eLink OSI TP product automatically “types” output buffers that local services return to remote client programs.

2. After eLink OSI TP determines a buffer's type, it refers to the configuration file (`DMCONFIG`) to determine whether the buffer needs to be converted to a different format.

Client requests sent to remote services may need to be converted to record formats that are meaningful to those services.

Server responses returned to remote client programs may need to be converted to record formats that are meaningful to those programs.

3. If the configuration indicates that conversion is required, eLink OSI TP transforms the buffer into the record format that is specified in the configuration.

Records Received from Remote Programs

The eLink OSI TP gateway processes records from remote programs in the following manner.

1. When eLink OSI TP receives a record from a remote system, it refers to the domain configuration (`DMCONFIG`) to determine the record's type and whether the record needs to be converted to a different format.

Client requests from remote client programs may need to be converted to buffer formats that are acceptable to local service routines.

Server responses returned from remote services may need to be converted to buffer formats that are acceptable to local client programs.

2. If the configuration indicates that conversion is required, eLink OSI TP transforms the record into the buffer format that is specified in the configuration.

Managing Parameters for Buffer and Record Conversion

The eLink OSI TP product provides four configuration parameters you can use to map buffers and records. These parameters are optional.

The following buffer configuration parameters are specified in the `DM_LOCAL_SERVICES` and/or the `DM_REMOTE_SERVICES` sections of the domain configuration file (`DMCONFIG`) as appropriate.

INBUFTYPE

Identifies the type, and in some cases the format, of a buffer received from a Tuxedo client or server. This restricts the buffer type naming space of data types accepted by this service to a single buffer type.

OUTBUFTYPE

Identifies the type, and in some cases the format, of a buffer to be sent to a Tuxedo client or server. Use this parameter to specify the type and format to translate the incoming message to.

INRECTYPE

Identifies the type, and in some cases the format, of a record to be sent to a remote gateway. This parameter is used for buffer and record translation.

OUTRECTYPE

Identifies the type, and in some cases the format, of a record received from a remote gateway.

The definitions of these four parameters depend on whether the service requests originate locally or remotely. The following sections describe these parameters in relation to where the service request originates.

Parameters for Locally Originated Calls

This section describes in more detail how eLink OSI TP handles service calls that originate locally, within the immediate BEA Tuxedo region. It also explains how the `INBUFTYPE`, `INRECTYPE`, `OUTRECTYPE`, and `OUTBUFTYPE` parameters can be used to manage the conversion of buffers and records that flow between local client programs and remote services.

In the following figure, a local BEA Tuxedo client program issues a service call that a local eLink OSI TP gateway routes to a remote server through eLink OSI TP.

Figure 2-3 Figure 3-1 How Parameters Are Mapped During Locally Originated Calls

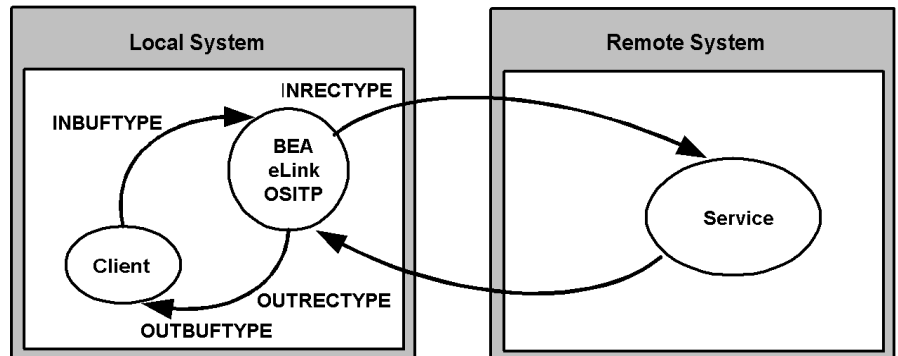

In this situation, the four configuration parameters that are shown in the figure have the following meanings:

- The `INBUFTYPE` parameter describes the BEA Tuxedo input buffer that the local client program provides to the eLink OSI TP gateway through BEA Tuxedo software. When this parameter is specified, the data type and subtype are verified.
- The `INRECTYPE` parameter describes the input record that is sent to the service on the remote system.
- The `OUTRECTYPE` parameter describes the output record that is received from the service on the remote system.
- The `OUTBUFTYPE` parameter describes the BEA Tuxedo output buffer that is returned to the local client program.

Guidelines for Mapping Input Buffers to Input Records

The following sections provide detailed information explaining how to use the `INBUFTYPE` and `INRECTYPE` parameters for service calls that originate locally (where local client programs call remote services).

INBUFTYPE

The `INBUFTYPE` parameter is used to specify the request buffer type that is provided to a local eLink OSI TP gateway when a local client program issues a service request. Tuxedo uses this information to restrict the buffer type from the local client to only the types defined by the `INBUFTYPE` parameter.

INRECTYPE

The `INRECTYPE` parameter is used to specify the type, and in some cases the format, of the request record that a particular remote service requires. The eLink OSI TP gateway uses this information to convert BEA Tuxedo request buffers into records that remote services can process.

The `INRECTYPE` parameter may be omitted if the request buffer is identical, in type and structure, to the request record the remote service expects.

You must specify the `INRECTYPE` parameter when one of the cases described in the following table is true.

Case	Explanation
The remote service uses an input record that is structured differently from the client program's request buffer	The remote service uses a record that is structured differently from the client program's <code>VIEW</code> , <code>X_C_TYPE</code> , or <code>X_COMMON</code> buffer. For example, the remote service may expect structure members to be sequenced differently.
The remote service uses a request record that differs from the client program's request buffer in both type and structure.	The client program uses a BEA Tuxedo <code>FML</code> buffer and the remote service expects a corresponding record with an appropriate structure.

Guidelines for Mapping Output Records to Output Buffers

The following sections provide detailed information explaining how to use the `OUTRECTYPE` and `OUTBUFTYPE` parameters for service calls that originate locally (where local client programs call remote services and receive output from those services).

OUTBUFTYPE

The `OUTBUFTYPE` parameter is used to specify the type, and in some cases the structure, of the reply buffer that a local client program expects. The eLink OSI TP gateway uses this information to map reply records from remote services to the appropriate kinds of reply buffers. The eLink OSI TP maps the incoming record to the type and subtype defined by the `OUTBUFTYPE` parameter.

OUTRECTYPE

The `OUTRECTYPE` parameter is used to specify the type, and in some cases the format, of the reply record that a particular remote service returns to the local eLink OSI TP gateway. The eLink OSI TP maps the incoming record to the type and subtype defined by the `OUTBUFTYPE` parameter.

The `OUTBUFTYPE` parameter may be omitted if the remote service returns a reply record that is identical, in type and structure, to the reply buffer the local client program expects.

You must specify the `OUTBUFTYPE` parameter when one of the cases described in the following table is true.

Case	Explanation
The remote service returns a reply record that is structured differently from the reply buffer the local client program expects.	The remote service returns a record that is structured differently from the client program's <code>VIEW</code> , <code>X_C_TYPE</code> , or <code>X_COMMON</code> buffer. For example, the structure members of the output record may be sequenced differently than the structure members of the output buffer.
The remote service returns a reply record that differs in both type and structure from the reply buffer the client program expects.	The remote service returns a particular record and the local client program expects a corresponding BEA Tuxedo FML buffer.

Parameters for Remotely Originated Calls

This section describes how eLink OSI TP handles service calls that originate on remote computers, outside the local BEA Tuxedo region. It also explains how the `INRECTYPE`, `INBUFTYPE`, `OUTBUFTYPE`, and `OUTRECTYPE` parameters can be used to manage the conversion of buffers and records that flow between remote client programs and local services.

In the following figure, a remote client program issues a service request that a remote eLink OSI TP gateway routes to the local eLink OSI TP gateway. The gateway receives the request from the network and passes the request to a local BEA Tuxedo server.

Figure 2-4 How Parameters Are Mapped During Remotely Originated Calls

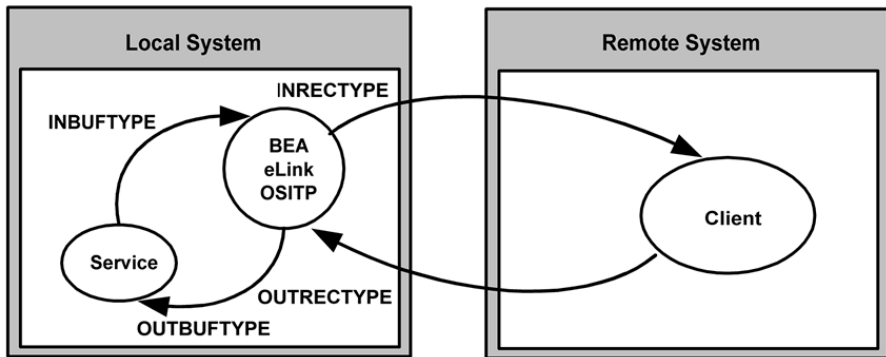

In this situation, the four configuration parameters that are shown in the figure have the following meanings:

- The `OUTRECTYPE` parameter describes the record that the remote client sends to the eLink OSI TP gateway.
- The `OUTBUFTYPE` parameter describes the BEA Tuxedo buffer that is provided to the local server.
- The `INBUFTYPE` parameter describes the BEA Tuxedo buffer that the local server returns to the eLink OSI TP gateway.
- The `INRECTYPE` parameter describes the record that the local eLink OSI TP gateway returns to the remote client program.

Guidelines for Mapping Input Records to Input Buffers

This section provides detailed information explaining how to use the `INRECTYPE` and `INBUFTYPE` parameters for service calls that originate on remote systems (where remote client programs call local services).

INBUFTYPE

The `INBUFTYPE` parameter is used to specify the type, and in some cases the structure, of the reply buffer that the eLink OSI TP gateway expects from a local server. This restricts the buffer type naming space of data types accepted by this service to a single buffer type. Because the gateway determines the type of buffer automatically at runtime this parameter is described here for conceptual completeness only.

INRECTYPE

The `INRECTYPE` parameter is used to specify the type, and in some cases the format, of the reply record that the local eLink OSI TP gateway sends to the remote client. You can omit the `INRECTYPE` parameter if the local server program sends a reply buffer that is identical in type and structure to the reply record the remote client expects.

You must specify the `INRECTYPE` parameter when one of the cases described in the following table is true.

Case	Explanation
The remote client program requires a reply record that is structured differently from the reply buffer the local service provides.	The remote client program sends a record that is structured differently than the local service's <code>VIEW</code> , <code>X_C_TYPE</code> , or <code>X_COMMON</code> buffer. For example, the structure members of the input record may be sequenced differently than the structure members of the input buffer.
The remote client program requires a reply record that differs in both type and structure from the reply buffer the local service provides.	The remote client program requires a particular record and the local service provides a corresponding BEA Tuxedo <code>FML</code> buffer.

Guidelines for Mapping Output Buffers to Output Records

This section provides detailed information explaining how to use the `OUTBUFTYPE` and `OUTRECTYPE` parameters for service calls that originate on remote computers (where remote client programs call local services and receive output from those services).

OUTBUFTYPE

The `OUTBUFTYPE` parameter specifies the request buffer type that the local eLink OSI TP gateway provides to the local server. The eLink OSI TP gateway uses this information to convert request records from remote clients into buffers that local server programs can process.

OUTRECTYPE

The `OUTRECTYPE` parameter is used to specify the type, and in some cases the format, of the request record a particular remote client program sends to the eLink OSI TP gateway. The eLink OSI TP maps the incoming record to the type and subtype defined by the `OUTRECTYPE` parameter.

The `OUTBUFTYPE` parameter may be omitted if the local service's request buffer is identical, in type and structure, to the request record the remote client program provides.

You must specify the `OUTBUFTYPE` parameter when one of the cases described in the following table is true.

Case	Explanation
The remote client program provides a request record that is structured differently from the local service's request buffer.	The remote client program provides a record that is structured differently than the local service's <code>VIEW</code> , <code>X_C_TYPE</code> , or <code>X_COMMON</code> buffer. For example, the local server program may expect structure members to be sequenced differently.
The remote client program provides a request record that differs from the local service's request buffer in both type and structure.	The remote client outputs a record and the local service program expects a corresponding BEA Tuxedo FML buffer.

Mapping Buffers to Records

The following figure shows all the possibilities for mapping buffers to records. The eLink OSI TP gateway is responsible for mapping buffers to records based on information it finds in the eLink OSI TP configuration. This mapping occurs for Tuxedo client requests and Tuxedo server responses.

Figure 2-5 Buffer to Record Mappings

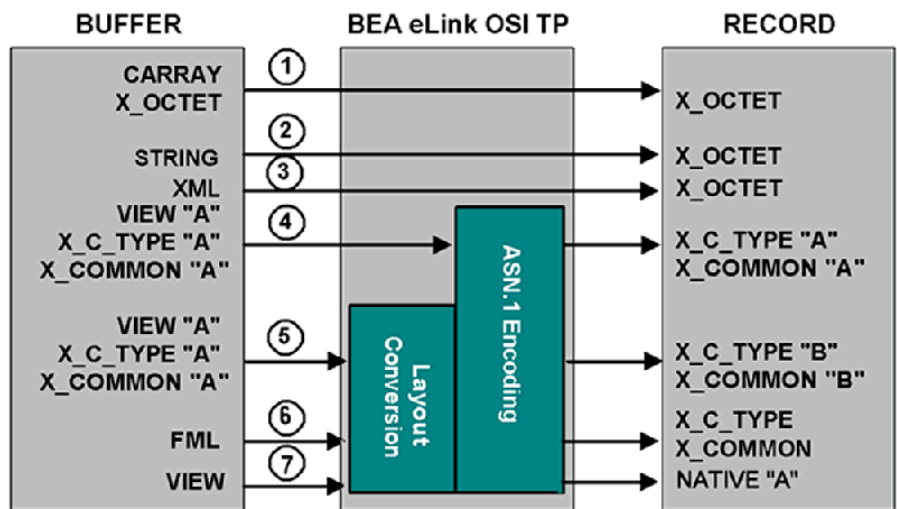

Following are explanations about the mapping possibilities shown in the figure above and some suggestions for setting the `INRECTYPE` parameter. The `INBUFTYPE` parameter is only used for verification purposes and is not discussed here.

1. BEA Tuxedo `CARRY` input buffers can be copied to `X_OCTET` input records. A `CARRY` buffer contains raw data that is not converted or translated. The eLink OSI TP gateway automatically sends the `CARRY` Tuxedo buffer as `X_OCTET` to the remote system; there is no need to set the `INRECTYPE` parameter.

2. BEA Tuxedo `STRING` input buffers can be mapped to `X_OCTET` input records. No data conversion or translation is performed. The `STRING` buffer is copied left to right, up to and including the first `NULL` character encountered. The eLink OSI TP gateway automatically sends the `STRING` buffer as `X_OCTET`; there is no need to set the `INRECTYPE` parameter.
3. BEA Tuxedo `XML` input buffers can be mapped to `X_OCTET` input records. The `XML` buffer is copied to an `X_OCTET` buffer. There is no translation or conversion performed on the data. This can be useful when passing `XML` data to systems that do not support `XML` data types.
4. BEA Tuxedo `VIEW` input buffers can be mapped to `X_COMMON` or `X_C_TYPE` input records. Specify the desired record type and the name of this `VIEW` definition with the `INRECTYPE` parameter. The eLink OSI TP gateway translates the `VIEW` into the correct `X_COMMON` or `X_C_TYPE` input record.
5. BEA Tuxedo `VIEW`, `X_COMMON` or `X_C_TYPE` input buffers can be mapped to `X_COMMON` or `X_C_TYPE` input records—in any combination. However, in this situation, the data structure that the remote service expects (designated as `X_COMMON `B'` mapping possibilities in Figure 3-3) differs from the data structure the client program uses (designated as `VIEW `A'` in Figure 3-3). Consequently, you must
 - a. Create a `VIEW` definition for the data structure that the remote service expects.
 - b. Specify the desired record type and the name of this `VIEW` definition with the `INRECTYPE` parameter.
6. Before a BEA Tuxedo `FML` input buffer can be sent to a remote service that does not support `FML`, it must be mapped to one of the following input record types: `X_C_TYPE` or `X_COMMON`. Also, you must create a `VIEW` definition for the input data structure that the remote service expects. Set `INRECTYPE` to `VIEW:viewname`. Refer to the BEA Tuxedo online documentation for more detailed information about `FML` translation.

Note: If the source and target `VIEW` names are different, `FML` fields must be specified for all `VIEW` to `VIEW` conversions that eLink OSI TP performs (For example, `VIEW=v10.v --> X_C_TYPE=v10.v` does not require `FML` mapping fields). In other words, any `VIEW` that is to be used in a `VIEW` to different `VIEW`, `VIEW` to `FML`, or `FML` to `VIEW` conversion must be defined with appropriate `FML` fields (no dashes in the `FNAME` column of the `VIEW` definition). In order for the `FML` fields to match, you must compile the `VIEW`s without the `-n` option specified.

- The Native-A encoding feature in eLink OSI TP converts Tuxedo VIEW buffer types into NATIVE A record types. This feature moves most of the encode/decode processing from the A-Series to the Tuxedo system.

Mapping Records to Buffers

The following figure shows all the possibilities for mapping records to buffers. The eLink OSI TP gateway is responsible for mapping records to buffers, based on information it finds in the eLink OSI TP configuration. This mapping occurs for remote client requests and remote server responses.

Figure 2-6 Record to Buffer Mappings

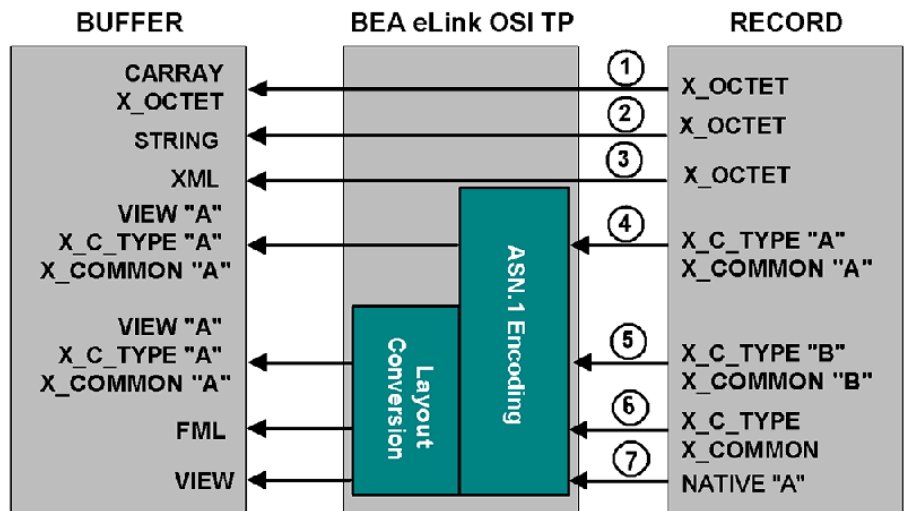

Following are explanations about the mapping possibilities shown in the figure above and some suggestions for setting the OUTBUFTYPE parameter (for service calls that originate locally. These suggestions use the OUTBUFTYPE parameter, which controls data translation.

1. Incoming `X_OCTET` output records can be copied to `CARRAY` or `X_OCTET` output buffers. A `CARRAY` buffer contains raw data that is not converted or translated. Set the `OUTBUFTYPE` to either `CARRAY` or `X_OCTET`; the `OUTRECTYPE` does not need to be set.
2. Incoming `X_OCTET` output records can also be copied to `STRING` output buffers. This creates a string that goes through no conversion and no translation. The resultant buffer is the length of the original `X_OCTET` buffer. Since all characters are copied, if the `X_OCTET` buffer contains null characters, it affects the buffer when later handled as a `STRING`. The `OUTBUFTYPE` should be set to `STRING`.
3. Incoming `X_OCTET` output records can be mapped to `XML` output buffers. No translation or conversion is performed on the data. This can be useful when passing `XML` buffers from systems that do not support `XML` buffer types to a Tuxedo domain that does support `XML` data types.
4. Incoming output records can be mapped to identical BEA Tuxedo `VIEW` output buffers. In this situation, the data structure that the remote service returns is identical to the data structure the local client program expects. There is no need to create a new `VIEW` definition. The `OUTRECTYPE` parameter can be set to `VIEW:viewname`, for greater type checking, but it is not mandatory.
5. Incoming `X_C_TYPE` and `X_COMMON` output records can be mapped to `VIEW` output buffers—in any combination. However, in this situation, the data structure that the remote service returns (designated as `X_C_TYPE `B'` in [Figure 2-6](#)) differs from the data structure the client program expects (designated as `VIEW `A'` in [Figure 2-6](#)). To facilitate the conversion process, perform the following tasks.
 - Create a `VIEW` definition for the data structure that the remote service returns.
 - If the name given to the `VIEW` definition is different from the name that the remote service returns (that is, `ATMI` buffer subtype), specify the output record type and the name of `X_C_TYPE` (or `X_COMMON`) ``B'` with the `OUTBUFTYPE` parameter. (By doing this, you override the value the eLink OSI TP requester automatically detects.)
 - Specify the output buffer type and the name of an existing view (`VIEW `A'` in the figure) specified in the `OUTBUFTYPE` parameter.

Note: FML Field definitions may be required to map `VIEW 'B'` to `VIEW 'A'`.

6. Incoming `X_COMMON` or `X_C_TYPE` output records can be mapped to FML output buffers. To facilitate the conversion process, you must perform the following tasks.
 - Create a `VIEW` definition that describes the data structure that the remote service returns.
 - If the name given to the `VIEW` definition is different from the name that the remote service returns (that is, the `ATMI` buffer subtype), specify the output record type and the name of your `VIEW` definition with the `OUTBUFTYPE` parameter. (By doing this, you override the value the eLink OSI TP requester automatically detects.)
 - If verification of the FML buffer is desired, set the `OUTBUFTYPE` to `FML` or `FML32` in the `DMCONFIG` followed by a colon(:). (Example:
`OUTBUFTYPE="FML32:"`)

Note: FML fields must be specified for all FML to `VIEW` conversions that eLink OSI TP performs. In other words, any `VIEW` that is to be used in an FML to `VIEW` conversion must be defined with appropriate FML fields (no dashes in the `FBNAME` column of the `VIEW` definition). In order for the FML fields to match, you must compile the `VIEW`s without the `-n` option specified.
7. Incoming `NATIVE A` output records can be mapped to `VIEW` output buffers.

Special Cases and Examples of Buffer Conversion

Following are some examples of special cases and considerations for buffer conversion.

- If the incoming buffer (`INBUFTYPE`) or (`OUTRECTYPE`) = `STRING`, `CARRAY`, `X-OCTET`, or `XML` the conversion type must be `STRING`, `CARRAY`, `X-OCTET`, or `XML`

- Conversion must be between 16-bit buffers, or between 32-bit buffers. You can not convert a 16-bit buffer to a 32-bit buffer, or vice versa.

Examples:

- a. `OUTRECTYPE="VIEW:v10"`
`OUTBUFTYPE="VIEW:v12" /* OK */`
- b. `OUTRECTYPE="VIEW:v10"`
`OUTBUFTYPE="VIEW32:v13" /* ERROR */`
- c. `OUTRECTYPE="VIEW32:v13"`
`OUTBUFTYPE="FML32:" /* OK */`
- d. `OUTRECTYPE="VIEW32:v13"`
`OUTBUFTYPE="FML:" /* ERROR */`

- If `INBUFTYPE` = "FML" or "FML32": or if the buffer being sent to a remote service is of type "FML" or "FML32", then...

`INRECTYPE`, of the remote service, **must** be configured to "VIEW" or "VIEW32", respectively.

- `INRECTYPE` and `OUTRECTYPE` cannot be "FML" or "FML32".

```
INRECTYPE="FML:" /* ERROR */
OUTRECTYPE="FML32:" /* ERROR */
```

- For `INBUFTYPE` and `OUTBUFTYPE`, configure buffer type FML as follows:

```
INBUFTYPE="FML:"
OUTBUFTYPE="FML32:"
```

Note: A colon is required at the end of keywords FML and FML32.

- `INBUFTYPE` and `OUTRECTYPE` must be configured to the same type/subtype as the incoming buffer type/subtype.
- Packed decimal type `dec_t` cannot be used in views participating in a conversion when either the source or the destination buffer is FML or FML32 or when the source and destination are two different views.
- Packed decimal type `dec_t` cannot be used in views participating in conversion to NATIVE A buffers.
- For views participating in conversion, substitute view fields of type `int` with fields of type `long` or `short`.

- If a View member contains system default values, that member will not be transferred during buffer conversion. To force the transfer, use "NONE" in the default Null column of the source View file.

DMCONFIG Examples for Conversion to View32 and FML

In the following example, incoming buffer X_COMMON:v10 gets converted to VIEW:v12 before the request is sent to the service.

Listing 2-1 Conversion to View32

```
*DM_REMOTE_SERVICES
TOUPPER12
RDOM=DALNT2
LDOM=DALNT19220
PRIO=66
RNAME="TOUPPER12"
INBUFTYPE="X_COMMON:v10"
INRECTYPE="VIEW:v12"
```

In the following example, incoming buffer VIEW:v12 gets converted to FML, before the request is sent to the local service, and FML gets converted to X_C_TYPE:v16 before the reply is returned to the remote client.

Listing 2-2 Conversion to FML

```
*DM_LOCAL_SERVICES
OUTRECTYPE="VIEW:v12"
OUTBUFTYPE="FML:"
INBUFTYPE="FML:"
INRECTYPE="X_C_TYPE:v16"
```

For more information about FML, refer to the BEA Tuxedo Online Documentation at <http://edocs.bea.com/Tuxedo>.

XML Buffer Support

BEA eLink OSI TP supports Tuxedo XML buffer types. XML buffers are treated like X_OCTET buffers because they are only passed through to the network. No data conversion is performed on the data.

XML buffers are passed to the remote domain as an XML data type unless converted to X_OCTET. If the remote domain does not support the XML data type, a decoding error occurs on the remote domain.

2 *Managing Transactions and Buffers*

3 Understanding the DMCONFIG File

Before you configure BEA eLink OSI TP and set up the gateway configuration, it is helpful to understand the `DMCONFIG` file.

This section covers the following topics:

- [“Overview of the DMCONFIG File”](#)
- [“DMCONFIG File Format”](#)
- [“DMCONFIG File Sections”](#)
- [“Methods for Modifying Configurations”](#)

For detailed instructions on how to configure eLink OSI TP by modifying the `DMCONFIG` file, refer to [“Configuring BEA eLink OSI TP.”](#)

Overview of the DMCONFIG File

The configuration specified in the `DMCONFIG` file controls much of the operation of the eLink OSI TP gateway. A sample of this file is provided in the installation directory of your eLink OSI TP product software.

`DMCONFIG` is the ASCII version of a Tuxedo System/Domain domain configuration file. The `DMCONFIG` file is parsed and loaded into a binary version by the `dmloadcf` utility. The binary configuration file, called the `BDMCONFIG`, contains information used by domain gateways to initialize the context required for communications with other

domains. In its monitoring activity, `dmadmin` uses the binary file (or a copy of it). There is one `BDMCONFIG` file for each Tuxedo System/Domain application that uses the /Domain feature. Refer to Processing a Configuration File with the `dmloadcf` Utility for more information about the binary configuration files.

A `DMCONFIG` file, and its binary `BDMCONFIG` counterpart, are analogous to the `UBBCONFIG` and `TUXCONFIG` files of a non-/Domain System/T application. The `DMCONFIG` file extends the definition of a non-/Domain System/T application so that the application becomes a domain.

OSI TP Application Addresses Used in the DMCONFIG File

OSI TP application address information is used for several parameters in the `DMCONFIG` file. The address of a Tuxedo application using OSI TP consists of a collection of the names of each of the components described in [Table 3-1](#). These names must coordinate with the remote domain OSI TP implementation.

Starting with eLink OSI TP 4.0, the OSI TP implementation is optimized to eliminate several layers of the protocol stack. As a result, the `P_SEL`, `S_SEL`, and `T_SEL` are not used for routing connections. Connections are routed solely based on the `NWADDR` parameter. Therefore, eLink requires the `NWADDR` parameter be unique.

■ Multiplexed Protocol

The multiplexed protocol uses a TCP/IP connection. Therefore, if the multiplexed protocol is in use, `P_SEL`, `S_SEL`, and `T_SEL` parameters do not apply and are ignored if configured.

■ Non-multiplexed Protocol

The non-multiplexed protocol sends messages using OSI over TCP/IP (as implemented in RFC1006). When using the non-multiplexed protocol, you may need to specify the `P_SEL`, `S_SEL`, and/or `T_SEL` parameters, depending on the addressing requirements of the remote system. If the `P_SEL`, `S_SEL`, and/or `T_SEL` are configured, eLink encodes the selectors for outgoing connections and eLink validates incoming connections to verify the selectors are correct. However, eLink OSI TP does not require the use of `P_SEL`, `S_SEL`, and `T_SEL`.

Table 3-1 OSI TP Application Components

Component	Description
Application Entity Title (AET)	A dotted integer based on the ISO Object Identifier Based NameForm that uniquely identifies the OSI TP node. See the following description of the AET, “Creating an Application Entity Title.”
* Presentation Selector (P_SEL)	A logical name for the address of the software that provides the presentation layer services for OSI protocols.
* Session Selector (S_SEL)	A logical name for the address of the software that provides the session layer services for OSI protocols.
* Transport Selector (T_SEL)	A logical name for the address of the software that provides the transport layer services for OSI protocols.
Network Address (NWADDR)	A globally unique computer system address used to identify the OSI TP node.

* Application components only valid for non-multiplexing communications.

Creating an Application Entity Title

The Application Entity Title equals the APT (application process title) plus the AEQ (application entity qualifier). Each OSI TP node in your network must have a unique AET. If your site is participating in a global OSI network, you need to contact the OSI registration authority for a valid OSI Object-ID, otherwise, create your own unique AET as described below.

If your site is in a closed network, create an Object ID with at least three “arcs”. Each arc is a dotted integer and represents an identifier for the Object ID. A valid OSI TP Object ID has either 0 or 1 for the first arc, and 0,1,2,or 3 for the second arc.

One suggested convention is to set APT to 1.3, followed by the IP address specified in the corresponding NWADDR parameter and set the AEQ to the port number specified in the NWADDR parameter. For example:

```
domain1
AET="{1.3.123.55.222.51},{12344}"
NWADDR="123.55.222.51:12344"
```

DMCONFIG File Format

The format of a domain configuration file is as follows:

- The file is made up of eight possible specification sections. Lines beginning with an asterisk (*) indicate the beginning of a specification section. Each such line contains the name of the section immediately following the *. Refer to [“DMCONFIG File Sections”](#) for more information about the sections.
- Parameters are generally specified by: *KEYWORD = value*. This sets *KEYWORD* to *value*. Valid keywords are described in the following sections. *KEYWORDS* are reserved; they cannot be used as *values* unless they are enclosed in quotes.

Caution: Enter all parameters on separate lines. The `NWADDR` parameter is the only exception; multiple network address values may be listed in a single line.

- Lines beginning with the reserved word, `DEFAULT:`, contain parameter specifications that apply to all the lines that follow in the section in which they appear. Default specifications can be used in any of the sections. Defaults can appear more than once in the same section. The format for these lines is:

```
DEFAULT: { KEYWORD1 = value1 { KEYWORD2 = value2 { ... } } }
```

The values set on this line remain in effect until reset by another `DEFAULT:` line, or until the end of the section is reached. These values can also be overridden by specifying another value for the parameter on a non-`DEFAULT:` line. The override parameter setting is valid for that line only; lines that follow revert to the default setting. If `DEFAULT:` appears on a line without any keywords or values, all previously set defaults are cleared and their values revert to the system defaults.

- If a value is *numeric*, standard C notation is used to denote the base (that is, 0x prefix for base 16 (hexadecimal), 0 prefix for base 8 (octal), and no prefix for base 10 (decimal)). The range of values acceptable for a numeric parameter are given in the description of that parameter.

- If a value is an *identifier*, standard C rules are used. An *identifier* must start with an alphabetic character or underscore and contain only alphanumeric characters or underscores. The maximum allowable length of an identifier is 30 (not including the terminating null). An identifier cannot be the same as any *KEYWORD*.
- A value that is neither an integer number nor an identifier must be enclosed in double quotes. Certain special characters can be included in a string by preceding them with a backslash.
 - “\” translates to a single backslash
 - “\”” translates to a double quote
 - “\n” translates to a new line
 - “\t” translates to a tab
 - “\f” translates to a form feed
 - “\x” (where x is any character other than one of the previously mentioned special characters) translates to x
- Input fields are separated by at least one space (or tab) character
- “#” introduces a comment. A new line ends a comment
- Blank lines and comments are ignored
- Comments can be freely attached to the end of any line
- Lines are continued by placing at least one tab after the new line. Comments cannot be continued

DMCONFIG File Sections

The DMCONFIG file consists of the following sections and parameters that define new gateway configurations.

- [DM_LOCAL_DOMAINS Section](#)

Note: The DM_LOCAL_DOMAINS section must precede the DM_REMOTE_DOMAINS section.

- [DM_REMOTE_DOMAINS Section](#)
- [DM_OSITPX Section](#)
- [DM_ACCESS_CONTROL Section](#)
- [DM_LOCAL_SERVICES Section](#)
- [DM_REMOTE_SERVICES Section](#)
- [DM_ROUTING Section](#)

Following is a sample configuration file and detailed descriptions of the DMCONFIG file sections and the parameters applicable to each section.

Sample Configuration File

The following sample DMCONFIG file represents non-multiplexing communication.

Listing 3-1 Sample DMCONFIG File (Non-multiplexing)

```
*DM_LOCAL_DOMAINS

dalnt8
GWGRP      = OSIGRP
TYPE       = OSITPX
DOMAINID   = "dalnt8"
BLOCKTIME  = 30
DMTLOGDEV  = "D:\tuxedo\log\DMLOG"
SECURITY   = DM_PW # turns link layer security on
DMTLOGNAME = DMLOG

*DM_REMOTE_DOMAINS

dal2200 TYPE=OSITPX DOMAINID="dal2200"
openti  TYPE=OSITPX DOMAINID="openti"
ic12    TYPE=OSITPX DOMAINID="ic12"
aseries1 TYPE=OSITPX DOMAINID="aseries1"

*DM_OSITPX

dalnt8
```

```
AET="{1.3.132.61.146},{3}"
TAILOR_PATH="d:\tuxedo\configs\tailor.txt"
NWADDR="//dalnt8:102"
DNS_RESOLUTION=STARTUP # this is the default

dal2200
AET="{1.3.132.61.46},{3}"
XATMI_ENCODING="OLTP_TM2200"
NWADDR="132.61.46.3;132.61.147.1" #redundant IP addresses
T_SEL="OSITP"

openti
AET="{1.3.122.62.103},{209}"
NWADDR="122.62.103.209:2001"
OPTIONS=SECURITY_SUPPORTED

icl2
AET="{1.3.142.60.203},{4}"
NWADDR="142.60.203.4"
T_SEL="ICLTP"
S_SEL="SSEL"
P_SEL="PSEL"

aseries1
AET="{1.3.123.55.222},{51}"
NWADDR="123.55.222.51"
XATMI_ENCODING="PRELIMINARY"
T_SEL="0x5453"
S_SEL="0x3F5C3F"

*DM_ACCESS_CONTROL
mylist ACLIST = dalnt8, dal2200

*DM_LOCAL_SERVICES
TOUPPERF
  INRECTYPE="VIEW:view10"
  OUTBUFTYPE="FML:"
  COUPLING=LOOSE #this is the default

TOUPPERF32
  INRECTYPE="VIEW:view10a"
  OUTBUFTYPE="FML32:"
  COUPLING=TIGHT

TOUPPERV
  INBUFTYPE="X_C_TYPE:v10"
  INRECTYPE="VIEW:upper"
  COUPLING=LOOSE
```

3 Understanding the DMCONFIG File

```
TOUPPERC OUTRECTYPE="X_OCTET" OUTBUFTYPE="CARRAY"  
INRECTYPE="X_OCTET"  
COUPLING=TIGHT  
  
TOUPPERS OUTRECTYPE="X_OCTET" OUTBUFTYPE="STRING"  
INRECTYPE="X_OCTET"  
  
TOUPPERX OUTRECTYPE="STRING" OUTBUFTYPE="STRING"  
INRECTYPE="X_OCTET"  
  
*DM_REMOTE_SERVICES  
DEFAULT: TRANTIME=300  
  
ECHOXOCT RNAME="ECHOSRVR" OUTBUFTYPE="X_COMMON:ECHOVIEW"  
RDOM=aseries1 LDOM=daInt8  
ECHOXCOM RNAME="ECHOSRVR" RDOM=openti LDOM=daInt8 AUTOPREPARE=Y  
  
ECHOXCTYPE RNAME="ECHOSRVR"  
INBUFTYPE="X_C_TYPE:ECHOVIEW"  
INRECTYPE="X_COMMON:ECHOVIEW"  
OUTBUFTYPE="X_C_TYPE:ECHOVIEW"  
OUTRECTYPE="X_COMMON:ECHOVIEW"  
RDOM=aseries1  
LDOM=daInt8  
CONV=Y  
ECHOVIEW RNAME="ECHOSRVR"  
INBUFTYPE="VIEW:ECHOVIEW"  
INRECTYPE="X_COMMON:ECHOVIEW"  
OUTBUFTYPE="VIEW:ECHOVIEW"  
OUTRECTYPE="X_COMMON:ECHOVIEW"  
RDOM=openti  
LDOM=daInt8  
TPSUT_TYPE = "PRINTABLESTRING"  
REM_TPSUT="tpmvs"  
  
*DM_ROUTING  
ACCOUNT FIELD = branchid BUFTYPE = "View:account"  
RANGE = "MIN - 1000:aseries1, 1001-3000:openti"
```

The following sample DMCONFIG file represents multiplexing communication.

Listing 3-2 Sample DMLCONFIG File (Multiplexing)

```

*DM_LOCAL_DOMAINS

dalnt8
GWGRP          = OSIGRP
TYPE           = OSITPX
DOMAINID      = "dalnt8"
BLOCKTIME     = 30
DMTLOGDEV     = "D:\tuxedo\log\DMLOG"
SECURITY      = DM_PW # turns link layer security on
DMTLOGNAME    = DMLOG

*DM_REMOTE_DOMAINS

openti  TYPE=OSITPX DOMAINID="openti"
aseries1 TYPE=OSITPX DOMAINID="aseries1"

*DM_OSITPX

dalnt8
  EXTENSIONS="MULTIPLEX_POLICY=DEMAND"
  AET="{1.3.132.61.146},{3}"
  TAILOR_PATH="d:\tuxedo\configs\tailor.txt"
  NWADDR="//dalnt8:2020"
  DNS_RESOLUTION=STARTUP # this is the default

openti
  EXTENSIONS="MULTIPLEX=Y"
  AET="{1.3.122.62.103},{209}"
  NWADDR="122.62.103.209:2001"
  OPTIONS=SECURITY_SUPPORTED

aseries1
  EXTENSIONS="MULTIPLEX=Y"
  AET="{1.3.123.55.222},{51}"
  NWADDR="123.55.222.51:12344"
  XATMI_ENCODING="NATIVE_A_SERIES"

*DM_ACCESS_CONTROL
mylist  ACLIST = dalnt8, openti

*DM_LOCAL_SERVICES
TOUPPERF
  INRECTYPE="VIEW:view10"
  OUTBUFTYPE="FML:"
  COUPLING=LOOSE #this is the default

```

3 Understanding the DMCONFIG File

```
TOUPPERF32
  INRECTYPE="VIEW:view10a"
  OUTBUFTYPE="FML32:"
  COUPLING=TIGHT

TOUPPERV
  INBUFTYPE="X_C_TYPE:v10"
  INRECTYPE="VIEW:upper"
  COUPLING=LOOSE

TOUPPERC OUTRECTYPE="X_OCTET" OUTBUFTYPE="CARRAY"
  INRECTYPE="X_OCTET"
  COUPLING=TIGHT

TOUPPERS OUTRECTYPE="X_OCTET" OUTBUFTYPE="STRING"
  INRECTYPE="X_OCTET"

TOUPPERX OUTRECTYPE="STRING" OUTBUFTYPE="STRING"
  INRECTYPE="X_OCTET"

*DM_REMOTE_SERVICES
DEFAULT: TRANTIME=300

ECHOXOCT RNAME="ECHOSRVR" OUTBUFTYPE="X_COMMON:ECHOVIEW"
RDOM=dal2200 LDOM=dalnt8
ECHOXCOM RNAME="ECHOSRVR" RDOM=openti LDOM=dalnt8 AUTOPREPARE=Y

ECHOXCTYPE RNAME="ECHOSRVR"
  INBUFTYPE="X_C_TYPE:ECHOVIEW"
  INRECTYPE="X_COMMON:ECHOVIEW"
  OUTBUFTYPE="X_C_TYPE:ECHOVIEW"
  OUTRECTYPE="X_COMMON:ECHOVIEW"
  RDOM=aseries1
  LDOM=dalnt8
  CONV=Y
ECHOVIEW RNAME="ECHOSRVR"
  INBUFTYPE="VIEW:ECHOVIEW"
  INRECTYPE="X_COMMON:ECHOVIEW"
  OUTBUFTYPE="VIEW:ECHOVIEW"
  OUTRECTYPE="X_COMMON:ECHOVIEW"
  RDOM=icl2
  LDOM=dalnt8
  TPSUT_TYPE = "PRINTABLESTRING"
  REM_TPSUT="tpmvs"

*DM_ROUTING
```

```
ACCOUNT FIELD = branchid BUFTYPE = "View:account"
RANGE = "MIN - 1000:aseries1, 1001-3000:openti, *:dal2200"
```

DM_LOCAL_DOMAINS Section

This section identifies local domains and their associated gateway groups. The section must have an entry for each gateway group (Local Domain). Each entry specifies the parameters required for the domain gateway processes running in that group.

Format

DM_LOCAL_DOMAINS entries have the following format.

LDOM required parameters [*optional parameters*]

where

LDOM is an *identifier* value used to name each local domain.

LDOM must be unique within a particular configuration. As described in the DM_LOCAL_SERVICES section, *LDOM* is the identifier that connects local services with a particular gateway group.

Valid Parameters

Following is a list of valid parameters for the DM_LOCAL_DOMAINS section:

Parameter	Required/ Optional	Description
AUDITLOG	Optional	Name of the audit log
BLOCKTIME	Optional	Maximum wait time allowed for a blocking call
DMTLOGDEV	Optional	Tuxedo file system that contains the domain transaction log
DMTLOGNAME	Optional	Name of the domain transaction log
DMTLOGSIZE	Optional	Size of the domain transaction log

Parameter	Required/ Optional	Description
DOMAINID	Required	Local domain
GWGRP	Required	Name of gateway server group
MAXRDTRAN	Optional	Maximum number of remote domains that can be involved in a transaction
MAXTRAN	Optional	Maximum number of simultaneous global transactions allowed on local domain
SECURITY	Optional	Link-level of security for local domain
TYPE	Required	Classification of local domain

Parameter Definitions

Following is more detailed information about each of the `DM_LOCAL_DOMAINS` section parameters:

AUDITLOG = *“string”*

Specifies the name of the audit log file for this local domain. The audit log feature is activated from the `dmadmin` command and records all the operations within this local domain. If the audit log feature is active and this parameter is not specified, the file, `DMmmddyy.LOG` (where `mm`=month, `dd`=day, and `yy`=year), is created in the directory specified by the `$APPDIR` environment variable or the `APPDIR` keyword of the `*MACHINES` section of the `TUXCONFIG` file.

BLOCKTIME = *numeric*

Specifies the maximum wait time allowed for a blocking call. The value sets a multiplier of the `SCANUNIT` parameters specified in the `TUXCONFIG` file. The value `SCANUNIT * BLOCKTIME` must be greater than or equal to `SCANUNIT` and less than 32,768 seconds. `BLOCKTIME` may need to be increased due to remote network latency or if security is turned on. If this parameter is not specified, the default value is set to the value of the `BLOCKTIME` parameter specified in the `TUXCONFIG` file. A timeout always implies a failure of the affected request. Notice that the timeout specified for transactions in the `TUXCONFIG` is always used when the request is issued within a transaction.

DMTLOGDEV= *“string”*

Specifies the Tuxedo file system that contains the Domain transaction log (DMTLOG) for this machine. The DMTLOG is stored as a Tuxedo System VTOC table on the device. If this parameter is not specified, the domain gateway group is not allowed to process requests in transaction mode. Local domains running on the same machine can share the same DMTLOGDEV file system, but each local domain must have its own log (a table in the DMTLOGDEV) named as specified by the DMTLOGNAME keyword.

DMTLOGNAME = *“string”*

Specifies the name of the domain transaction log for this domain. This name must be unique when the same DMTLOGDEV is used for several local domains. If not specified, the default is the string “DMTLOG”. The name must be 30 characters or less.

DMTLOGSIZE = *numeric*

specifies the numeric size, in pages, of the domain transaction log for this machine. It must be greater than 0 and less than the amount of available space on the Tuxedo file system. If not specified, the default is 100 pages.

DOMAINID = *“string”*

identifies the local domain. DOMAINID must be unique across both local and remote domains. The value of *string* can be a sequence of characters (for example, “BA.CENTRAL01”), or a sequence of hexadecimal digits preceded by “0x” (for example, “0x0002FF98C0000B9D6”). DOMAINID must be 32 octets or fewer in length. If the value is a string, it must be 31 characters or fewer.

GWGRP = *identifier*

specifies the name of the gateway server group (the name provided in the TUXCONFIG file) representing this local domain. There is a one-to-one relationship between a DOMAINID and the name of the gateway server group, that is, each GWGRP must have its own, unique DOMAINID.

MAXRDTRAN = *numeric*

specifies the maximum number of remote domains that can be involved in a transaction. It must be greater than 0 and less than 32,768. If not specified, the default is 16.

MAXTRAN = *numeric*

specifies the maximum number of simultaneous global transactions allowed on this local domain. It must be greater than or equal to 0 and less than or equal to the MAXGTT parameter specified in the TUXCONFIG file. MAXGTT is the

maximum number of transactions for all the domains on a given machine. If not specified, the default is the value of `MAXGTT`.

`SECURITY = {NONE | DM_PW}`

specifies whether link-level security for the local domain is turned on. When this parameter is set to `DM_PW`, incoming connections from remote domains are authenticated using the passwords defined in the `*DM_PASSWORDS` section of the `BDMCONFIG` file. In order to pass userids to the remote domain for user authentication, `SECURITY=DM_PW` must be set. The default is `NONE` and indicates that no security is used.

Note: This parameter must appear **AFTER** the `TYPE=OSITPX` parameter.

`TYPE = identifier`

groups local domains into classes. `TYPE` can be set to one of the following values: `TDOMAIN` or `OSITPX`. The `TDOMAIN` value indicates that this local domain can only communicate with another Tuxedo System/Domain. The `OSITPX` value indicates that this local domain communicates with another TP Domain via the OSI TP protocol. Domain types must be defined in the `$TUXDIR/udataobj/DMTYPE` file. The eLink OSI TP install automatically updates the `DMTYPE` file with the required type needed.

See Also

Refer to [Table A-1 “DM_LOCAL_DOMAINS SECTION”](#) for more information about setting these parameters through the `dmadmin` utility.

DM_REMOTE_DOMAINS Section

This section identifies the known set of remote domains and their characteristics.

Format

`DM_REMOTE_DOMAINS` entries have the following format:

RDOM required parameters [*optional parameters*]

where

RDOM is an *identifier* value used to identify each remote domain known to this configuration.

RDOM must be unique within the configuration.

Valid Parameters

Following is a list of valid parameters for the `DM_REMOTE_DOMAINS` section:

Parameter	Required/ Optional	Description
DOMAINID	Required	ID of remote domain.
TYPE	Required	Class of remote domain
CODEPAGE	Optional	Codepage translation table for <code>NATIVE_A_SERIES</code> encoding.

Parameter Definitions

Following is more detailed information about each of the `DM_REMOTE_DOMAINS` section parameters:

`DOMAINID` = *string*

identifies a remote domain. `DOMAINID` must be 32 octets or fewer in length. If the value is a string, it must be 31 characters or fewer. `DOMAINID` must be unique across remote domains. The value of *string* can be a sequence of characters or a sequence of hexadecimal digits preceded by "0x".

`TYPE` = *identifier*

groups remote domains into classes. `TYPE` can be set to one of the following values: `TDOMAIN` or `OSITPX`. The `TDOMAIN` value indicates that this remote domain can only communicate with another Tuxedo System/Domain Domain. The `OSITPX` value indicates that this remote domain communicates with another TP domain via the OSI TP protocol.

`CODEPAGE` = *CPNAME*

specifies the codepage translation table for `NATIVE_A_SERIES` encoding. The `cpname` keyword is case sensitive. This parameter is only valid when

XATMI_ENCODING=NATIVE_A_SERIES. Refer to Implementing NATIVE-A Encoding for more information.

See Also

Refer to [Table A-2 “DM_REMOTE_DOMAINS SECTION”](#) for more information about setting these parameters through the `dmadmin` utility.

DM_OSITPX Section

This section defines the addressing information required by domains of type `OSITPX`. This section should have at least one entry per gateway group (local domain), and at least one entry per remote domain of type `OSITPX`. The bridged configuration can have multiple gateways in a local domain.

Format

`DM_OSITPX` entries have the following format.

DOM required parameters [*optional parameters*]

where

DOM is an *identifier* value used to identify a local domain (`LDM`) or a remote domain (`RDM`) in the `DM_LOCAL_DOMAINS` section or in the `DM_REMOTE_DOMAINS` section.

The *DOM* identifier must match a previously defined `LDM` in the `DM_LOCAL_DOMAINS` sections or `RDM` in the `DM_REMOTE_DOMAINS` section.

Valid Parameters

Following is a list of valid parameters for the `DM_OSITPX` section:

Parameter	Required/ Optional	Description
AET	Required for LDOMS and RDOMS	Application entity title
DNS_RESOLUTION	Optional for LDOMS	Indicator for when DNS name is resolved
EXTENSIONS	Optional for LDOMS and RDOMS	Series of parameters to control operation of the LDOM and RDOM.
NWADDR	Required for LDOMS and RDOMS	List of IP addresses with their optional port numbers or a DNS name and its optional port number
OPTIONS	Optional for RDOMS	Optional flags to turn on OSI TP features such as security
P_SEL	Optional for LDOMS and RDOMS	Logical name of address for software that provides presentation layer services
S_SEL	Optional for LDOMS and RDOMS	Logical name of address for software that provides session layer services
T_SEL	Optional for LDOMS and RDOMS This parameter is ignored for multiplexed LDOMS.	Logical name of address for software that provides transport layer services
TAILOR_PATH	Optional for LDOMS	Path to optional OSI TP tailor file
XATMI_ENCODING	Optional for RDOMS	Version of XATMI protocol

Parameter Definitions

Following is more detailed information about each of the DM_OSITPX section parameters:

AET = “*string*”

indicates the application entity title that this LDOM or RDOM uses. This address must be unique among all hosts communicating in the OSI TP network. This number matches the local AE Title on the remote (OLTP) node. Refer to OSI TP Domains Components for more information about AETs.

The format accepted for the value of *string* is

“{*object identifier*}, {*integer*}”

The first element represents the APT defined as an object identifier (i.e., a sequence of integer values separated by periods) and the second element represents an AEQ defined as an integer constant, for example,

AET = “{1.3.15.0.3}, {1}”.

For more information about creating an application entity Title, refer to [“Creating an Application Entity Title.”](#)

Note: The braces are part of the syntax and **must** be included within the quotes.

DNS_RESOLUTION = {STARTUP | RUNTIME}

indicates whether the DNS name should be resolved when the gateway is started or at runtime. The DNS name is for the network address defined by NWADDR. The runtime option allows support of DHCP networks. When using DNS_RESOLUTION as a runtime option, failed services may occur due to delays in resolving the DNS names. DNS_RESOLUTION, when configured for an LDOM, indicates the policy for the entire gateway process.

The default is STARTUP.

STARTUP

indicates the DNS name is resolved when the gateway is booted and never resolved again.

RUNTIME

indicates the DNS name is resolved again when needed. If three minutes of inactivity has elapsed, the DNS server is pinged for resolution (in case the address changes).

EXTENSIONS = *"string"*

controls operations. Valid parameters are separated by a semi-colon ";" and include the following:

For RDOMs, valid parameters are:

"MULTIPLEX={Y|N}"

The default is N.

Y indicates that this RDOM uses the multiplexed protocol.

N indicates that this RDOM uses the non-multiplexed protocol.

"ONLINE={N|Y}"

The default is Y.

Y indicates that the RDOM is considered online initially. If MULTIPLEX=N and MULTIPLEX_POLICY=NONE for the corresponding LDOM, then a socket connection is established from the LDOM to the RDOM at startup to verify that the RDOM is available. If MULTIPLEX=Y and MULTIPLEX_POLICY=STARTUP for the corresponding LDOM, then a socket connection is established from the LDOM to the RDOM at startup. If MULTIPLEX=Y and MULTIPLEX_POLICY=DEMAND for the corresponding LDOM, then a socket connection is established from the LDOM to the RDOM the first time it is needed.

N indicates that the RDOM is considered to be offline initially. No socket connection is established from the LDOM to the RDOM at startup, even if MULTIPLEX_POLICY=STARTUP for the corresponding LDOM. No incoming socket requests are allowed from an offline RDOM.

"RDOMASSOCRETRY=*n*"

The default is given by the TAILOR parameter `RdomAssocRetry` (refer to ["Tuning OSI TP-Specific Tables with the TAILOR File."](#)) *n* is a numeric value which represents the time in seconds between association retries for unavailable RDOMs. This value only applies if MULTIPLEX=N. If MULTIPLEX=Y, this value is ignored; the multiplex protocol has its own algorithm for determining how often to retry connection attempts.

For LDOMs, valid parameters are:

MULTIPLEX_POLICY={STARTUP|DEMAND|NONE}

The default is NONE.

NONE indicates that this LDOM uses the non-multiplexed protocol.

STARTUP indicates that this LDOM uses the multiplexed protocol and a single socket connection is established between the LDOM and each RDOM that has MULTIPLEX=Y and ONLINE=Y at startup.

DEMAND indicates the LDOM uses the multiplexed protocol and a single socket connection is established between the LDOM and an RDOM that has MULTIPLEX=Y the first time it is needed.

NWADDR = "*string*"

indicates the network address that this LDOM or RDOM uses and, optionally, the port number. The network address may be either an IP address, if using TCP/IP networks, or a DNS name. The default port number is port 102. For local domains, the NWADDR specifies which IP address eLink OSI TP will listen on. For remote domains, the NWADDR specifies which network messages will be sent on. You may list multiple network addresses by listing each individual address separated by semicolons if the machine is equipped with multiple network cards. Make sure to enter all the IP addresses on one line and separate them with a semi-colon (;). You may want to configure redundant network paths: up to 8 may be specified.

Note: You must explicitly specify a port number greater than or equal to 1024 if *all* the following are true:

- the platform is Unix
- the userid running Tuxedo is *not* root
- this is an LDOM
- MULTIPLEX_POLICY is DEMAND or STARTUP (multiplexing is in use)

Examples:

"#. #. #. #:port-number" IP Address

"//host-name:port-number" DNS Name

"//host-name:port-number; //host-name:port-number" Redundant DNS Names

OPTIONS = SECURITY_SUPPORTED

indicates optional parameters for RDOMs. The SECURITY_SUPPORTED value indicates that this remote domain supports the OSITP security extension. This value provides backward compatibility and is valid only when describing an RDOM.

P_SEL = "string" or "hex digits"

specifies the logical name for the address of the software that provides the presentation layer services for OSI protocols. The value can be one to 4 ASCII non-control characters (those represented by the hexadecimal numbers 20 to 7E), one to 4 hexadecimal octets, or NONE (null). A value of NONE is the default. Examples: "PSEL", "0x3F5C"

Note: This value is ignored for multiplexed connections. For additional information about when to use this parameter for defining application addresses, refer to ["OSI TP Application Addresses Used in the DMLCONFIG File."](#)

S_SEL = "string" or "hex digits"

specifies the logical name for the address of the software that provides the session layer services for OSI protocols. The value can be one to 16 ASCII non-control characters (those represented by the hexadecimal numbers 20 to 7E), one to 16 hexadecimal octets, or NONE (null). A value of NONE is the default. Examples: "SSEL", "0x3F5C3F"

Note: This value is ignored for multiplexed connections. For additional information about when to use this parameter for defining application addresses, refer to ["OSI TP Application Addresses Used in the DMLCONFIG File."](#)

T_SEL = "string" or "hex digits"

represents the logical name for the address of the software that provides the transport layer services for OSI protocols. The value can be one to 32 ASCII non-control characters (those represented by the hexadecimal numbers 20 to 7E), one to 32 hexadecimal octets, or NONE (null). Examples: "OSITP", "0x5453"

Note: This value is ignored for multiplexed connections. For additional information about when to use this parameter for defining application addresses, refer to ["OSI TP Application Addresses Used in the DMLCONFIG File."](#)

`TAILOR_PATH = "string"`

indicates the full path to the optional OSI TP tailor file used for tuning OSI TP-specific tables. Double quotes are required. If not specified, preset defaults are used. This parameter is valid only when describing an LDOM. Refer to Tuning OSI TP-Specific Tables with the TAILOR File for more information.

`XATMI_ENCODING = {CAE | PRELIMINARY | OLTP_TM2200 | NATIVE_A_SERIES}`

specifies the version of the XATMI protocol used to communicate with a remote application. This parameter is only valid for an RDOM. Valid values are:

`CAE` (default)

`PRELIMINARY` (used specifically with Unisys MCP OLTP systems)

`OLTP_TM2200` (used specifically with Unisys TM 2200 systems)

`NATIVE_A_SERIES` (used specifically with Unisys MCP OLTP systems that support this encoding type)

See Also

Refer to [Table A-3 “DM_OSITPX SECTION”](#) for more information about setting these parameters through the `dmadmin` utility.

DM_ACCESS_CONTROL Section

This section specifies the access control lists used by local domain.

Format

`DM_ACCESS_CONTROL` entries have the following format.

`ACL_NAME` required parameters

where

`ACL_NAME` is a (*identifier*) name used to identify a particular access control list; it must be 15 characters or less in length.

Valid Parameters

Following is a list of valid parameters for the `DM_ACCESS_CONTROL` section:

Parameter	Required/ Optional	Description
<code>ACLIST</code>	Required	List of remote domain names

Parameter Definitions

Following is more detailed information about the `DM_ACCESS_CONTROL` section parameter:

`ACLIST = identifier [,identifier]`

indicates one or more remote domain names (RDOM) separated by commas. The wildcard character (*) can be used to specify that all the remote domains defined in the `DM_REMOTE_DOMAINS` section can access a local domain.

See Also

Refer to [Table A-7 “DM_ACCESS_CONTROL SECTION”](#) for more information about setting these parameters through the `dmadmin` utility.

DM_LOCAL_SERVICES Section

This section provides information on the services exported by each local domain. This section is optional and if it is not specified then all local domains defined in the `DM_LOCAL_DOMAINS` section accept requests to all of the services advertised by the Tuxedo System/Domain application. If this section is defined then it should be used to restrict the set of local services that can be requested from a remote domain.

Format

`DM_LOCAL_SERVICES` entries have the following format.

service [*optional parameters*]

where

service is the (identifier) local name of the exported service, and it must be 15 characters or fewer in length.

This name corresponds to a name advertised by one or more servers running with the local Tuxedo System/Domain application. Notice that exported services inherit the default or special properties specified for the service in an entry in the SERVICES section of the TUXCONFIG file. Some of these parameters are: LOAD, PRIO, AUTOTRAN, ROUTING, BUFTYPE, and TRANTIME.

Valid Parameters

Following is a list of valid parameters for the DM_LOCAL_SERVICES section:

Parameter	Required/ Optional	Description
ACL	Optional	Name of access control list
COUPLING	Optional	Indicator for type of coupling
INBUFTYPE	Optional	Type and subtype of buffer returned by local service
INRECTYPE	Optional	Type and format of the reply buffer expected by remote client
LDOM	Optional	Name of local domain exporting a service
OUTBUFTYPE	Optional	Type and format of request buffer expected by local service
OUTRECTYPE	Optional	Type and format of request buffer expected by local service
RNAME	Optional	Name of service exported to remote domains

Parameter Definitions

Following is more detailed information about the DM_LOCAL_SERVICES section parameters:

ACL = *identifier*

specifies the name of the access control list (ACL) to be used by the local domain to restrict requests made to this service by remote domains. The name of the ACL is defined in the `DM_ACCESS_CONTROL` section. If this parameter is not specified then access control is not performed for requests to this service.

COUPLING = {TIGHT | LOOSE}

specifies service (transaction) coupling to be tight or loose when requests for this local service come from the same remote domain. The default is `LOOSE`. This means data base updates made by the first request to this local service cannot be seen by the second request to the local service even though they are involved in the same global transaction. By making this value `TIGHT`, multiple calls to the same service from the same domain are tightly-coupled. Data base updates made by the first request can be seen by the second request. This option is only available when duplicate service requests come from the same RDOM. When the service requests are from different RDOMs, the requests are always loosely-coupled.

INBUFTYPE = type[:subtype]

specifies the type and subtype of the buffer. `INBUFTYPE` is used to enforce stronger type checking. In the `DM_LOCAL_SERVICES` section, the `TYPE` parameters are defined in reference to where the remote request originates. Refer to *Managing Parameters for Buffer and Record Conversion* for more information about these parameters.

INRECTYPE = type[:subtype]

specifies the type, and in some cases, the format of the reply buffer that a particular client requires. This parameter can be omitted if the local service sends a buffer that is identical in type and structure to the buffer the remote client expects. If you do not specify `INRECTYPE`, the type of buffer is unchanged. In the `DM_LOCAL_SERVICES` section, the `TYPE` parameters are defined in reference to where the remote request originates. Refer to *Managing Parameters for Buffer and Record Conversion* for more information about these parameters.

LDOM = *identifier*

specifies the name of the local domain exporting this service. If this keyword is not specified then all the local domains defined in the `DM_LOCAL_DOMAINS` section accept requests to this local service.

OUTBUFTYPE = type[:subtype]

specifies the type, and in some cases, the format of the request buffer that a particular local service expects. This parameter can be omitted if the remote client sends a buffer that is identical in type and structure to the buffer the local service expects. If you do not specify OUTRECTYPE, the type of the buffer is unchanged. In the `DM_LOCAL_SERVICES` section, the `TYPE` parameters are defined in reference to where the remote request originates. Refer to *Managing Parameters for Buffer and Record Conversion* for more information about these parameters.

OUTRECTYPE = type[:subtype]

specifies the type and subtype of the buffer sent by the remote client. This parameter is used to enforce stronger type checking. In the `DM_LOCAL_SERVICES` section, the `TYPE` parameters are defined in reference to where the remote request originates. Refer to *Managing Parameters for Buffer and Record Conversion* for more information about these parameters.

RNAME = "string"

specifies the name of the service exported to remote domains. This name is used by the remote domains for request to this service. If this parameter is not specified, the local service name is used for the request.

See Also

Refer to [Table A-4 "DM_LOCAL_SERVICES SECTION"](#) for more information about setting these parameters through the `dmadmin` utility.

DM_REMOTE_SERVICES Section

This section provides information on services *imported* and available on remote domains.

Format

`DM_REMOTE_SERVICES` entries have the following format.

service [*optional parameters*]

where

service is the (*identifier*) name used by the local Tuxedo System/Domain application for a particular remote service.

Remote services are associated with a particular remote domain.

Valid Parameters

Following is a list of valid parameters for the `DM_REMOTE_SERVICES` section:

Parameter	Required/ Optional	Description
AUTOPREPARE	Optional	Indicator to automatically prepare calls from tpcall.
CONV	Optional	Indicator that remote service is conversational.
INBUFTYPE	Optional	Type and subtype of buffer sent to the remote service.
INRECTYPE	Optional	Type and format of the request buffer expected by remote service.
LDOM	Optional	Name of local domain exporting a service.
OUTBUFTYPE	Optional	Type and format of reply buffer expected by local client.
OUTRECTYPE	Optional	Type and format of reply buffer returned by remote client.
RDOM	Optional	Name of remote domain responsible for execution of service.
REM_TPSUT	Optional	TP service user title.
RNAME	Optional	Name of service exported to remote domains.
ROUTING	Optional	Routing criteria used for data-dependent routing.
TPSUT_TYPE	Optional	Type for which the remote TP service user title is to be encoded.
TRANTIME	Optional	Default time-out value in seconds for transaction automatically started for associated service.

Parameter Definitions

Following is more detailed information about the `DM_REMOTE_SERVICES` section parameters:

`AUTOPREPARE = {N | Y}`

allows a single `tpcall()` involved in a global transaction to this remote service to automatically prepare the call. This optimization reduces the two-phase commit process to a single step. The remote OSITP domain must support this feature. The default is `N`.

`CONV = {Y | N}`

specifies whether or not the remote service is a conversational service. Use `Y` to specify the remote service is a conversational service. Use `N` to specify the remote service is not a conversational service. The default value is `N`.

`INBUFTYPE = type[:subtype]`

specifies the type and subtype of the buffer allocated by the client. This parameter is used to enforce stronger `type` checking. In the `DM_REMOTE_SERVICES` section, the `TYPE` parameters are defined in reference to where the local request originates. Refer to Managing Parameters for Buffer and Record Conversion for more information about these parameters.

`INRECTYPE = type[:subtype]`

specifies the type, and in some cases, the format of the request buffer that a particular remote service requires. This parameter can be omitted if the local client sends a buffer that is identical in type and structure to the buffer the remote service expects. If you do not specify `INRECTYPE`, the type of buffer is unchanged. In the `DM_REMOTE_SERVICES` section, the `TYPE` parameters are defined in reference to where the local request originates. Refer to Managing Parameters for Buffer and Record Conversion for more information about these parameters.

`LDOM = identifier`

specifies the name of a local domain in charge of routing requests to this remote service. The gateway group associated with the local domain advertises `service` in the Tuxedo System/Domain Bulletin Board. If this parameter is not specified, then all the local domains are able to accept requests to this remote service. The service request is then redirected to a remote domain of the same type (see the following definition for `RDOM` keyword).

OUTBUFTYPE = type[:subtype]

specifies the type, and in some cases, the format of the reply buffer that a particular local client expects. This parameter can be omitted if the remote service returns a buffer that is identical in type and structure to the buffer the local client expects. If you do not specify OUTRECTYPE, the type of the buffer is unchanged. In the DM_REMOTE_SERVICES section, the TYPE parameters are defined in reference to where the local request originates. Refer to Managing Parameters for Buffer and Record Conversion for more information about these parameters.

OUTRECTYPE = type[:subtype]

specifies the type and subtype of the buffer sent by the remote service. This parameter is used to enforce stronger type checking. In the DM_REMOTE_SERVICES section, the TYPE parameters are defined in reference to where the local request originates. Refer to Managing Parameters for Buffer and Record Conversion for more information about these parameters.

RDOM = *identifier*

specifies the name of the remote domain responsible for the actual execution of this service. If this parameter is not specified and a routing criteria (see the following definition for ROUTING keyword) is not specified, then the local domain assumes that any remote domain of the same type accepts this service and it selects a known domain (a domain to which a connection already exists) or remote domain from the DM_REMOTE_DOMAINS section.

REM_TPSUT = *"string"*

identifies the TP service user title for the remote system. Some users of OSI TP implementations require this field. It is not required for OS 2200 OLTP-TM2200, OpenTI, A Series Open/OLTP, or BEA eLink OSI TP. If the TPSUT_TYPE value is PRINTABLESTRING, the maximum length is 60 characters, which must comply with Abstract Syntax Notation (ASN.1) type of PRINTABLESTRING. If the TPSUT_TYPE value is an INTEGER, the maximum length must fit into a LONG. The TPSUT_TYPE must be defined prior to defining the remote TPSUT.

RNAME = *identifier*

specifies the remote service name expected by the remote domain. If this parameter is not specified, the value is the same as the name specified in the *service*.

ROUTING = *identifier*

allows a local domain to perform data-dependent routing when more than one remote domain offers the same service. The *identifier* specifies the name of the routing criteria used for this data-dependent routing. If not specified, data-dependent routing is not done for this service. *identifier* must be 15 characters or less in length. If multiple entries exist for the same service name but with different RDOM parameters, the ROUTING parameter should be the same for all of these entries.

TPSUT_TYPE = {INTEGER | PRINTABLESTRING}

specifies the type of encoding to be performed on the REM_TPSUT parameter. The default type is PRINTABLESTRING. If TPSUT_TYPE is not specified, the default is used. The INTEGER and PRINTABLESTRING are ASN.1 types.

TRANTIME = *integer*

specifies the default time-out value in seconds for a transaction automatically started for the associated service. The value must be greater than or equal to 0 and less than 2147483648. The default is 30 seconds. A value of 0 implies the maximum time-out value for the machine.

See Also

Refer to [Table A-5 “DM_REMOTE_SERVICES SECTION”](#) for more information about setting these parameters through the `dmadmin` utility.

DM_ROUTING Section

This section provides information for data-dependent routing of service requests using FML, VIEW, X_C_TYPE, and X_COMMON typed buffers.

Format

DM_ROUTING entries have the following format.

CRITERION_NAME required parameters

where

CRITERION_NAME is the (*identifier*) name of the routing entry that was specified on the services entry. *CRITERION_NAME* must be 15 characters or less in length.

Valid Parameters

Following is a list of valid parameters for the DM_ROUTING section:

Parameter	Required/ Optional	Description
BUFTYPE	Required	Types and subtypes of data buffers for which this routing entry is valid
FIELD	Required	Name of routing field
RANGES	Required	Ranges and associated remote domain names (RDOM) for routing field

Parameter Definitions

Following is more detailed information about the DM_ROUTING section parameters:

BUFTYPE = "*type1[:subtype1{,subtype2 . . . }][;type2{:subtype3[, . . .]}] . . .*"

specifies types and subtypes of data buffers for which this routing entry is valid. The types are restricted to be either `FML`, `VIEW`, `X_C_TYPE`, or `X_COMMON`. No subtype can be specified for type `FML` and subtypes are required for the other types ("*" is not allowed). Duplicate type/subtype pairs cannot be specified for the same routing criterion name; more than one routing entry can have the same criterion name as long as the type/subtype pairs are unique. This parameter is required. If multiple buffer types are specified for a single routing entry, the data types of the routing field for each buffer type must be the same.

For `FML` buffers, if the field value is not set or does not match any specific range and a wildcard range has not been specified, an error is returned to the application process that requested the execution of the remote service.

FIELD = *identifier*

specifies the name of the routing field. It must be 30 characters or less. This field is assumed to be a field name that is identified in an `FML` field table (for

FML buffers) or an FML view table (for VIEW, X_C_TYPE, or X_COMMON buffers). The FLDTBLDIR and FIELDTBLS environment variables are used to locate FML field tables, and the VIEWDIR and VIEWFILES environment variables are used to locate FML view tables.

RANGES = “*string*”

specifies the ranges and associated remote domain names (RDOM) for the routing field. *string* must be enclosed in double quotes. The format of *string* is a comma-separated ordered list of range/RDOM pairs.

A range is either a single value (signed numeric value or character string in single quotes), or a range of the form “lower - upper” (where lower and upper are both signed numeric values or character strings in single quotes). Note that “lower” must be less than or equal to “upper.” To embed a single quote in a character string value (as in O’Brien, for example), it must be preceded by two backslashes (‘O\\’Brien’).

The value MIN can be used to indicate the minimum value for the data type of the associated FIELD; for strings and arrays, it is the null string. For character fields, it is 0; for numeric values, it is the minimum numeric value that can be stored in the field.

The value MAX can be used to indicate the maximum value for the data type of the associated FIELD; for strings and arrays, it is effectively an unlimited string of octal-255 characters; for a character field, it is a single octal-255 character; for numeric values, it is the maximum numeric value that can be stored in the field.

Thus, “MIN - -5” is all numbers less than or equal to -5 and “6 - MAX” is all numbers greater than or equal to 6. The meta-character “*” (wildcard) in the position of a range indicates any values not covered by the other ranges previously seen in the entry; only one wildcard range is allowed per entry and it should be last (ranges following it are ignored).

The routing field can be of any data type supported in FML. A numeric routing field must have numeric range values and a string routing field must have string range values.

String range values for string, array, and character field types must be placed inside a pair of single quotes and cannot be preceded by a sign. Short and long integer values are a string of digits, optionally preceded by a plus or minus sign. Floating point numbers are of the form accepted by the C compiler or atof(): an optional sign, then a string of digits optionally containing a

decimal point, then an optional e or E , followed by an optional sign or space, followed by an integer.

When a field value matches a range, the associated RDOM value specifies the remote domain to which the request should be routed. An RDOM value of “*” indicates that the request can go to any remote domain known by the gateway group. Within a range/RDOM pair, the range is separated from the RDOM by a “:”.

See Also

Refer to [Table A-6 “DM_ROUTING SECTION”](#) for more information about setting these parameters through the `dmadmin` utility.

Methods for Modifying Configurations

The BEA Tuxedo system provides three methods for modifying your eLink OSI TP configuration:

- **BEA Administration Console**

A Web-based graphical user interface (GUI) you can use to dynamically configure your application. You can display and change configuration information, determine the state of each component in the system, and obtain statistical information about items such as executed requests and queued requests.

- **Command-line utilities**

Most of the functionality needed for dynamic modification is provided by two commands: `dmadmin` and `dmconfig`. `dmadmin` is a shell-level command with over 70 subcommands for performing various administrative tasks, including dynamic system modification. `tmconfig` is a shell-level command that you can use to add and modify configuration entries while your system is running.

Refer to the [“Utilities Reference”](#) section of this document for more information.

- **MIB API**

3 *Understanding the DMCONFIG File*

A Management Information Base API that enables you to write your own programs to monitor your system and make dynamic changes to your system.

Refer to the "Dynamically Modifying an Application" section of your BEA Tuxedo 8.0 documentation for ATMI Administration for more detailed information about modifying your configuration.

4 Configuring BEA eLink OSI TP

After the installation of BEA eLink OSI TP is complete, you must configure the software. The proper configuration of eLink OSI TP sets up the gateway configuration.

This section covers the following topics:

- [“Configuration Prerequisites”](#)
- [“Setting Environment Variables”](#)
- [“Defining Gateway Configurations.”](#)
- [“Defining eLink OSI TP Servers for BEA Tuxedo”](#)
- [“Setting up Security”](#)
- [“Implementing Native-A Encoding”](#)
- [“Processing a Configuration File with the dmloadcf Utility”](#)
- [“Tuning OSI TP-Specific Tables with the TAILOR File”](#)

Configuration Prerequisites

The eLink OSI TP product software must be installed and accessible to your text editor. You must have file permission to access the `install` directory and modify the sample `DMCONFIG` file.

In addition, the following prerequisites must be met to successfully complete the configuration procedure:

- The `$TUXDIR/udataobj/DMTYPE` file defining the valid domain types must exist so the `dmloadcf` utility can load the binary configuration file and must contain a domain type of `OSITPX`. During the installation process if the `DMTYPE` file does not contain an OSI TP entry, the `DMTYPE` file is automatically updated with the required OSI TP domain type.
- The effective user identifier of the person running `dmloadcf` must match the `UID` in the `RESOURCES` section of the `TUXCONFIG` file.

Setting Environment Variables

Before you can invoke system commands, you must set several system environment variables. The following table provides descriptions of the four variables you must set. Most of the environment variables required by BEA eLink OSI TP are set when you set up Tuxedo. Refer to your Tuxedo documentation for more information about setting the Tuxedo environment variables.

Variable	Optional/ Required	Default	Description
OSIRUNDIR	Required	None	Indicates location of eLink OSI TP runtime files.
GW_DFLT_TRANTIME	Optional	300 seconds	Default transaction time for the server. Value is in seconds
GW_POLLING_INTERVAL	Optional	300 seconds	Internal Polling time for requests to be serviced. Value is in seconds; valid range is 10-10,000 seconds.

Variable	Optional/ Required	Default	Description
GW_TIMER_INTERVAL	Optional	300 (3 seconds)	Internal timer for global transaction requests. Value is in one hundredths (1/100) of a second. Valid values are 100-1000 indicating 1-10 seconds.

You must set `OSIRUNDIR`, before you can boot the gateway or run the `osiadmin` utility. If you do not set the `OSIRUNDIR` environment variable before you boot the gateway, you will receive a message telling you to set `OSIRUNDIR`. This environment variable specifies the path that the eLink gateway uses for runtime files. You can set the `OSIRUNDIR` environment variable through a script, a command line entry, or through the Windows System Properties in the Control Panel. The variable value should include the path and directory as appropriate for your operating system. If the directory does not exist, the system will create it for you.

The default transaction time on the server is determined at startup by an optional environment variable called `GW_DFLT_TRANTIME`. If you do not set this variable, the default value is 5 minutes (300 seconds). This environment variable can be set to a different value at startup, but if the value exceeds the maximum allowed for a `LONG`, then the value is reset to 300 and a `LIBGWO_CAT msg 2204` is sent to the `ULOG` to indicate that the maximum has been exceeded.

Note: The maximum for a `LONG` is 2147483647.

Defining Gateway Configurations

Whether you are defining a new gateway configuration or modifying an existing one, both processes are similar. Defining a gateway configuration requires the following steps:

1. Define the eLink OSI TP servers in Tuxedo so that the BEA eLink system can recognize the gateway servers. Refer to [Defining eLink OSI TP Servers for BEA Tuxedo](#) for more information.

2. Run the `osiadmin` processor if you are upgrading from eLink OSI TP 1.3. Refer to [Using the OSI TP Administration Utility](#) for more information.
3. Determine which parameter information needs to be added or changed to define the gateway. Refer to [Understanding the DMCONFIG File](#) for more information.
4. Edit the OSI TP Tailor file if OSI TP-specific tables need to be tuned. Refer to [Tuning OSI TP-Specific Tables with the TAILOR File](#) for more information.
5. Create or edit the `DMCONFIG` file with new gateway information. Refer to [Implementing Native-A Encoding](#) and [Understanding the DMCONFIG File](#) for more information.
6. Generate a binary version of the `dmconfig` file by running the `dmloadcf` utility. Refer to [Processing a Configuration File with the dmloadcf Utility](#) for more information.

After you perform these steps, you are ready to start the gateway using the Tuxedo `tmboot` command. Refer to the *BEA Tuxedo Online Documentation* for more information about Tuxedo commands.

Defining eLink OSI TP Servers for BEA Tuxedo

To establish a gateway configuration, the BEA Tuxedo system must recognize the gateway servers, `DMADM`, `GWADM`, and `GWOSITP`. You define the eLink OSI TP administrative and gateway servers to the BEA Tuxedo system by editing the `UBBCONFIG` file.

Perform the following steps to define eLink OSI TP servers for BEA Tuxedo:

1. In the `GROUPS` section of the `UBBCONFIG` file, add a server group using the following format:

```
OSIGRP GRPNO=1 LMID=SITE1
```

Note: `OSIGRP` is used as an example. You may give the group any name you wish.

2. In the `SERVERS` section of the `UBBCONFIG` file, add the three server names: `DMADM`, `GWADM`, and `GWOSITP`.

Notes: The `DMADM` and `GWADM` entries should be placed in this order **BEFORE** `GWOSITP` in the `UBBCONFIG` file so the admin servers are loaded before the `GWOSITP` gateway server.

It is recommended that you set the `RESTART` parameter in the `SERVERS` section to `Y` so that the gateway will automatically restart in case of failure.

Sample UBBCONFIG File

The following file is a sample `UBBCONFIG` file that defines gateway servers to the BEA Tuxedo system.

Listing 4-1 Sample UBBCONFIG File

```
#-----  
# Connect OSI Test; Client ubbconfig  
#-----  
  
*RESOURCES  
#-----  
# Replace IPCKEY  
#-----  
IPCKEY      52029  
MASTER     SITE1  
DOMAINID   FRONTEND  
PERM       0660  
MAXACCESSERS 40  
MAXSERVERS 80  
MAXSERVICES 80  
MAXCONV    120  
MODEL      SHM  
LDBAL      Y  
MAXGTT     120  
MAXBUFTYPE 16  
MAXBUFSTYPE 32  
SCANUNIT   5  
SANITYSCAN 10  
DBBLWAIT   5  
BBLQUERY   50
```

4 Configuring BEA eLink OSI TP

```
BLOCKTIME      15

*MACHINES
#-----
# Replace machine name
#-----
DALNT45        LMID=SITE1
#-----
# Replace directories as needed
#-----
TUXDIR="c:\tuxedo"
APPDIR="D:\dwh\base\ositp\test\client"
TUXCONFIG="D:\dwh\base\ositp\test\client\tuxconfig"
TLOGDEVICE="D:\dwh\base\ositp\test\client\TLOG"
TLOGNAME="TLOG"

*GROUPS
OSIGRP2        GRPNO=2  LMID=SITE1
OSIGRP3        GRPNO=3  LMID=SITE1  TMSNAME="TMS"  TMSCOUNT=2

*SERVERS
DEFAULT:      RESTART=Y
DMADM         SRVID=101  SRVGRP=OSIGRP2  CLOPT="-A"  REPLYQ=N
GWADM         SRVID=103  SRVGRP=OSIGRP2  CLOPT="-A"  REPLYQ=N
GWOSITP       SRVID=104  SRVGRP=OSIGRP2  CLOPT="-A"  GRACE=0"  REPLYQ=N
CRPCSERV      SRVID=8   SRVGRP=OSIGRP3  CLOPT="-A"  RQADDR="rpcq"
CCONVSRV      SRVID=9   SRVGRP=OSIGRP3  CLOPT="-A"  RQADDR="convq"  CONV=Y
              MIN=3  MAX=5

*SERVICES
DEFAULT:      LOAD=50  AUTOTRAN=N
CTOUPPER      PRIO=50
CCONVRTN      PRIO=50
CCONVRTN2     PRIO=50
CCONVRTN3     PRIO=50
CTOUPPER2     PRIO=50
```

Refer to the *BEA Tuxedo Reference Manual* for additional information about the UBBCONFIG file.

Example of a Multiple Gateway Configuration

Following is a sample UBBCONFIG file and corresponding DMCONFIG file for multiple gateways that reside on the same physical system. Note that use of LDBAL=Y in the UBBCONFIG file is not required for multiple gateways. Loads are automatically balanced for multiple gateways.

Listing 4-2 UBBCONFIG for Multiple Gateways

```
*RESOURCES
IPCKEY          65952
MASTER         "SITE1"
MODEL          SHM
PERM           0660
LDBAL          N   # not needed for gateway load balancing
MAXACCESSERS   40
MAXSERVERS     80
MAXSERVICES    80
MAXGTT         120
SCANUNIT       5
SANITYSCAN     10
BLOCKTIME      15
MAXCONV        120

*MACHINES
"SITE1"        LMID="SITE1"

                TUXCONFIG="D:\tuxedo\configs\TUXCONFIG"
                TUXDIR="D:\tuxedo"
                APPDIR="D:\tuxedo\apps"
                TLOGDEVICE="D:\tuxedo\log\TLOG"
                ULOGPFX="D:\tuxedo\log\ULOG"
                TLOGNAME=TLOG
                TLOGSIZE=20
                TYPE="SITE1"

*GROUPS

GROUP1         LMID="SITE1"
                GRPNO=1
GROUP2         LMID="SITE1"
                GRPNO=2

DMGRP          LMID="SITE1"
                GRPNO=3
```

4 Configuring BEA eLink OSI TP

```
*SERVERS

DEFAULT:      RQPERM=0666
              RPPERM=0666
              MIN=1
              MAX=1
              CONV=N
              MAXGEN=1
              GRACE=86400
              RESTART=Y
              SYSTEM_ACCESS=FASTPATH

DMADM        SRVGRP=DMGRP
              SRVID=20
              CLOPT=" -A "
              RESTART=Y
              MAXGEN=2
              REPLYQ=N

GWADM        SRVGRP=GROUP1
              SRVID=21
              CLOPT=" -A "
              RESTART=Y
              MAXGEN=2
              REPLYQ=N

GWOSITP     SRVGRP=GROUP1
              SRVID=22
              CLOPT=" -A "
              RESTART=Y
              MAXGEN=2
              REPLYQ=N

GWADM        SRVGRP=GROUP2
              SRVID=23
              CLOPT=" -A "
              RESTART=Y
              MAXGEN=2
              REPLYQ=N

GWOSITP     SRVGRP=GROUP2
              SRVID=24
              CLOPT=" -A "
              RESTART=Y
              MAXGEN=2
              REPLYQ=N
```



```
*SERVICES

DEFAULT:  LOAD=50 AUTOTRAN=N
```

Listing 4-3 DMCONFIG File for Multiple Gateways

```
*DM_RESOURCES
VERSION="SITE1"
#
*DM_LOCAL_DOMAINS

"GW-1 "
GWGRP      = GROUP1
TYPE       = OSITPX
DOMAINID   = "GW-1 "
BLOCKTIME  = 30
DMTLOGDEV  = "D:\tuxedo\log\DMLOG"

"GW-2 "
GWGRP      = GROUP2
TYPE       = OSITPX
DOMAINID   = "GW-2 "
BLOCKTIME  = 30
DMTLOGDEV  = "D:\tuxedo\log\DMLOG2"

#####
*DM_REMOTE_DOMAINS

DEFAULT:

"OPENTI " TYPE="OSITPX" DOMAINID="OPENTI "

#####
*DM_OSITPX

"GW-1 "
  AET="{1.3.145.62.103},{2}"
  TAILOR_PATH="d:\tuxedo\configs\tailor.txt"
                                     # Inserted from OSITP's config file:
  NWADDR="//SITE1:102"

"GW-2 "
  AET="{1.3.145.62.103},{3}"
  TAILOR_PATH="d:\tuxedo\configs\tailor2.txt"
                                     # Inserted from OSITP's config file:
```

4 Configuring BEA eLink OSI TP

```
NWADDR="//SITE1:2000" #second gateway must use another
                                #IP or different port number

"OPENTI"
    AET="{1.3.122.61.203},{20}"
    NWADDR="122.61.203.20"

*DM_LOCAL_SERVICES

*DM_REMOTE_SERVICES
DEFAULT: TRANTIME=300
    # Tuxedo will alternate outgoing calls between the two LDOMs.

callSvc2    RDOM="OPENTI" LDOM="GW-1" PRIO=66
callSvc2    RDOM="OPENTI" LDOM="GW-2" PRIO=66
```

The following example uses the same UBBCONFIG file as in [Listing 4-2](#) and shows how to configure one LDOM to support the non-multiplexed path and the other to support the multiplexed path.

Listing 4-4 DMCONFIG File for Multiplexed and non-Multiplexed Connections

```
*DM_RESOURCES
VERSION="SITE1"
#
*DM_LOCAL_DOMAINS

"GW-1"
GWGRP      = GROUP1
TYPE       = OSITPX
DOMAINID   = "GW-1"
BLOCKTIME  = 30
DMTLOGDEV  = "D:\tuxedo\log\DMLOG"

"GW-2"
GWGRP      = GROUP2
TYPE       = OSITPX
DOMAINID   = "GW-2"
BLOCKTIME  = 30
DMTLOGDEV  = "D:\tuxedo\log\DMLOG2"

#####
```

```
*DM_REMOTE_DOMAINS

DEFAULT:

"OPENTI" TYPE="OSITPX" DOMAINID="OPENTI"
"dal2200" TYPE="OSITPX" DOMAINID="dal2200"

#####
*DM_OSITPX

"GW-1"
    AET="{1.3.145.62.103},{2}"
    TAILOR_PATH="d:\tuxedo\configs\tailor.txt"
                                # Inserted from OSITP's config file:
    NWADDR="//SITE1:102"

"GW-2"
    AET="{1.3.145.62.103},{3}"
    TAILOR_PATH="d:\tuxedo\configs\tailor2.txt"
                                # Inserted from OSITP's config file:
    NWADDR="//SITE1:2000" #second gateway must use another
                                #IP or different port number
    EXTENSIONS="MULTIPLEX_POLICY=DEMAND"

"OPENTI"
    AET="{1.3.122.61.203},{20}"
    NWADDR="122.61.203.20:2003"
    EXTENSIONS="MULTIPLEX=Y"

"dal2200"
    AET="{1.3.132.61.46},{3}"
    XATMI_ENCODING="OLTP_TM2200"
    NWADDR="132.61.46.3;132.61.147.1" #redundant IP addresses
    T_SEL="OSITP"

*DM_LOCAL_SERVICES

*DM_REMOTE_SERVICES
DEFAULT: TRANTIME=300
    # Tuxedo will alternate outgoing calls between the two LDOMs.

CallSvc1  RDOM="dal2200" LDOM="GW-1" PRIO=66
callSvc2  RDOM="OPENTI" LDOM="GW-2" PRIO=66
```

Using the Tuxedo MP Model with the eLink OSI TP Gateway

It is useful to use the Tuxedo MP model (for multiprocessors that do not have global shared memory or for networked applications) when you require two eLink OSI TP systems to exist in the same domain. (Refer to the BEA Tuxedo documentation for more information about the `MODEL` parameter.) A practical example of this is setting up a Windows NT cluster. The eLink OSI TP gateway supports active-active failover on an NT cluster. In the MP model case, there are two unique nodes, one defined as the master and a second one defined as a slave or backup system in the case of clustering. There is one `UBBCONFIG` and one `DMCONFIG` that physically exist on the master node. At `TMBOOT` time, a copy of the `TUXCONFIG` is propagated to the slave or backup system.

Listing 4-5 UBBCONFIG File for MP Model

```
UBBCONFIG

*RESOURCES
IPCKEY          65952
MASTER         SITE1,SITE2
MODEL          MP
OPTIONS        LAN
PERM           0660
LDBAL          N   # not needed for gateway load balancing
MAXACCESSERS   40
MAXSERVERS     80
MAXSERVICES    80
MAXGTT         120
SCANUNIT       5
SANITYSCAN     10
BLOCKTIME     15
MAXCONV        120

*MACHINES
"SITE1"        LMID="SITE1"
               TUXCONFIG="D:\tuxedo\configs\TUXCONFIG"
               TUXDIR="D:\tuxedo"
               APPDIR="D:\tuxedo\apps"
               TLOGDEVICE="D:\tuxedo\log\TLOG"
               ULOGPFX="D:\tuxedo\log\ULOG"
               TLOGNAME=TLOG
```

```

TLOGSIZE=20
TYPE="INTEL"

"SITE2"      LMID="SITE2"
              TUXCONFIG="D:\tuxedo\configs\TUXCONFIG"
              TUXDIR="D:\tuxedo"
              APPDIR="D:\tuxedo\apps"
              TLOGDEVICE="D:\tuxedo\log\TLOG"
              ULOGPFX="D:\tuxedo\log\ULOG"
              TLOGNAME=TLOG
              TLOGSIZE=20
              TYPE="INTEL"

*GROUPS
GROUP1      LMID="SITE1"
              GRPNO=1
GROUP2      LMID="SITE2"
              GRPNO=2
DMGRP      LMID="SITE1"
              GRPNO=3

*NETWORK
SITE1      NADDR="/SITE1:5020"
              NLSADDR="//SITE1:5021"
SITE2      NADDR="//SITE2:5020"
              NLSADDR="//SITE2:5021"

*SERVERS
DEFAULT:   RQPERM=0666
              REPLYQ=Y
              RPPERM=0666
              MIN=1
              MAX=1
              CONV=N
              MAXGEN=1
              GRACE=86400
              RESTART=N
              SYSTEM_ACCESS=FASTPATH

DMADM      SRVGRP=DMGRP
              SRVID=20
              CLOPT="-A"
              RESTART=Y
              MAXGEN=2
              REPLYQ=N
    
```

4 Configuring BEA eLink OSI TP

```
GWADM          SRVGRP=GROUP1
                SRVID=22
                CLOPT=" -A "
                RESTART=Y
                MAXGEN=2
                REPLYQ=N

GWOSITP        SRVGRP=GROUP1
                SRVID=23
                CLOPT=" -A "
                RESTART=Y
                MAXGEN=2
                REPLYQ=N

GWADM          SRVGRP=GROUP2
                SRVID=24
                CLOPT=" -A "
                RESTART=Y
                MAXGEN=2
                REPLYQ=N

GWOSITP        SRVGRP=GROUP2
                SRVID=25
                CLOPT=" -A "
                RESTART=Y
                MAXGEN=2
                REPLYQ=N

*SERVICES
DEFAULT:      LOAD=50 AUTOTRAN=N
```

Listing 4-6 DMCONFIG File for MP Model

```
DMCONFIG

*DM_RESOURCES
VERSION="SITE1"
#
*DM_LOCAL_DOMAINS

"GW-1"
GWGRP          = GROUP1
TYPE           = OSITPX
DOMAINID       = "GW-1"
```

```

BLOCKTIME      = 30
DMTLOGDEV      = "D:\tuxedo\log\DMLOG1"
DMTLOGNAME     = "DMLOG"

"GW-2"
GWGRP          = GROUP2
TYPE           = OSITPX
DOMAINID      = "GW-2"
BLOCKTIME     = 30
DMTLOGDEV     = "D:\tuxedo\log\DMLOG2"
DMTLOGNAME    = "DMLOG"

#####
*DM_REMOTE_DOMAINS

DEFAULT:

"OPENTI" TYPE="OSITPX" DOMAINID="OPENTI"

#####
*DM_OSITPX

"GW-1"
           AET="{1.3.145.62.103},{2}"
           TAILOR_PATH="d:\tuxedo\configs\tailor1.txt"
           # Inserted from OSITPX's config file:
           NWADDR="//SITE1:102"

"GW-2"
           AET="{1.3.145.62.103},{3}"
           TAILOR_PATH="d:\tuxedo\configs\tailor2.txt"
           # Inserted from OSITPX's config file:
           NWADDR="//SITE2:102" # second gateway must use
                               # another IP or different
                               # port number

"OPENTI"
           AET="{1.3.122.61.203},{20}"
           NWADDR="122.61.203.20"

#####
#####*DM_LOCAL_SERVICES

#####
*DM_REMOTE_SERVICES
DEFAULT: TRANTIME=300
# Each system will service different applications.

```

```
callSvc2  RDOM="OPENTI" LDOM="GW-1" PRIO=66
callSvc3  RDOM="OPENTI" LDOM="GW-2" PRIO=66
```

Using eLink OSI TP as a Pass-Through to Other Tuxedo Systems

For this example, the eLink OSI TP gateway acts as a pass-through to allow access to services on other Tuxedo systems. The eLink OSI TP gateway receives service requests from a remote OLTP system and then forwards them through the /TDOMAINS gateway to a remote Tuxedo system. The systems are as follows:

Figure 4-1 Example of eLink OSI TP Acting as a Pass-Through to Other Tuxedo Systems

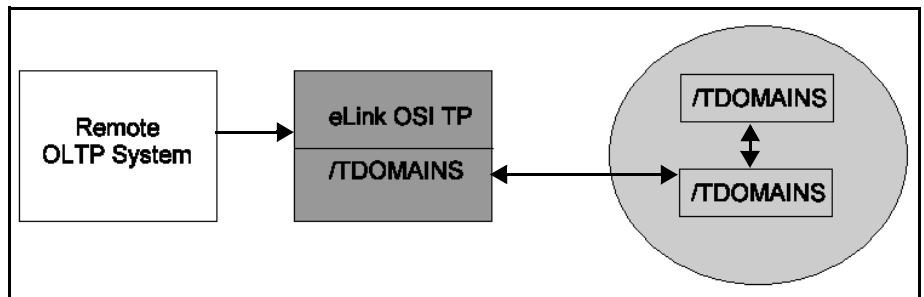

Listing 4-7 shows a sample UBBCONFIG file and Listing 4-8 shows the corresponding DMCONFIG file for a pass-through configuration.

Listing 4-7 Sample UBBCONFIG File for Pass-Through Configuration

```
*RESOURCES
IPCKEY      65952
MASTER     "SITE1"
MODEL       SHM
PERM        0777

*MACHINES
"SITE1" LMID="SITE1"
```



```

TUXCONFIG="D:\tuxedo\appdir\TUXCONFIG"
TUXDIR="D:\tuxedo"
APPDIR="D:\tuxedo\appdir"
TLOGDEVICE="D:\tuxedo\log\TLOG"
ULOGPFX="D:\tuxedo\log\ULOG"
TLOGNAME=TLOG
TLOGSIZE=20
TYPE="SITE1"

*GROUPS

ADMGRP      LMID="SITE1"
             GRPNO=1

OSIGRP      LMID="SITE1"
             GRPNO=2

TDOMGRP     LMID="SITE1"
             GRPNO=3
             OPENINFO=NONE

*SERVERS

DEFAULT:    RQPERM=0666
             RPPERM=0666
             MIN=1
             MAX=1
             CONV=N
             MAXGEN=1
             GRACE=86400
             RESTART=N
             SYSTEM_ACCESS=FASTPATH

DMADM       SRVGRP=ADMGRP
             SRVID=20
             CLOPT="-A"
             RESTART=N
             REPLYQ=N

GWADM       SRVGRP=OSIGRP
             SRVID=21
             CLOPT="-A"
             RESTART=N
             REPLYQ=N

GWOSITP     SRVGRP=OSIGRP
             SRVID=22
             CLOPT="-A"
             RESTART=Y
             REPLYQ=N
    
```

4 Configuring BEA eLink OSI TP

```
GWADM          SRVGRP=TDOMGRP
                SRVID=51
                CONV=N
                CLOPT=" -A "
                REPLYQ=N
                RESTART=N

GWTDOMAIN      SRVGRP=TDOMGRP
                SRVID=52
                CLOPT=" -A "
                REPLYQ=N
                RESTART=Y

*SERVICES

DEFAULT:      LOAD=50 AUTOTRAN=N
```

Listing 4-8 Sample DMCONFIG File for Pass-Through Configuration

```
*DM_RESOURCES
VERSION="SITE1"
#
*DM_LOCAL_DOMAINS

# SECURITY=NONE

"osi-local"
    GWGRP        = OSIGRP
    TYPE         = OSITPX
    DOMAINID     = "local"
    BLOCKTIME    = 2000
    AUDITLOG     = "D:\tuxedo\log\AUDIT"
    DMTLOGDEV    = "D:\tuxedo\log\DMLOG"
    DMTLOGSIZE   = 2048
    DMTLOGNAME   = "DMLOG"

"td-local"     GWGRP=TDOMGRP
                TYPE=TDOMAIN
                DOMAINID="td-local"
                DMTLOGDEV="D:\tuxedo\log\TDMLOG"

#####
*DM_REMOTE_DOMAINS
```

```
DEFAULT:

"osi-client" TYPE=OSITPX  DOMAINID="osi-client"
"td-backend" TYPE=TDOMAIN DOMAINID="td-tpaix1"

#####
*DM_TDOMAIN

"td-local"      NWADDR="192.63.22.2:5000"
"td-backend"    NWADDR="192.63.24.74:5000"
#####
*DM_OSITPX

"osi-local"
      AET="{1.3.192.63.22},{2}"
      TAILOR_PATH="d:\tuxedo\configs\tailor.txt"

# the NWADDR for OSI TP may have the same IP as /TDOMAINS, but
# requires a different port number
      NWADDR="192.63.22.2:102"

"osi-client"
      AET="{1.3.192.23.2},{3}"
      NWADDR="192.23.2.3"
      T_SEL="OSITP"

#####
*DM_LOCAL_SERVICES
# define the incoming services here, even though they reside on
# some remote /TDOMAIN machine.  Include views also on this machine
# for eLink OSI TP to process incoming messages

callSvc1

#####
*DM_REMOTE_SERVICES
DEFAULT:

# define the actual remote service request here.  It will be
# routed by /TDOMAINS

callSvc1  RDOM="td-backend"  LDOM="td-local"  RNAME="callSvc1"
```

Note that the service that resides on the backend /TDOMAIN system must be defined as a local service on the eLink OSI TP system, so eLink OSI TP can process the incoming request. It must also be defined as a remote service so that the /TDOMAIN gateway can

pass the service request to the backend /TDOMAIN system. The gateway system must have available the viewfiles and corresponding environment variables that are required by the service, even though the service exists on the backend system.

Setting up Security

BEA eLink OSI TP supports the following two types of security:

- Link Layer Security
- Tuxedo Authentication

The BEA Tuxedo `UBBCONFIG` and eLink OSI TP `DMCONFIG` files include five sections in which you specify security parameters for whichever type of security you want to implement:

- `RESOURCES` section of the `UBBCONFIG` file
- `DM_LOCAL_DOMAINS` section of the `DMCONFIG` file
- `DM_OSITPX` section of the `DMCONFIG` file
- `DM_ACCESS_CONTROL` section of the `DMCONFIG` file
- `DM_LOCAL_SERVICES` section of the `DMCONFIG` file

The following figure shows the relationships between security elements for eLink OSI TP.

Figure 4-2 eLink OSI TP Security Elements

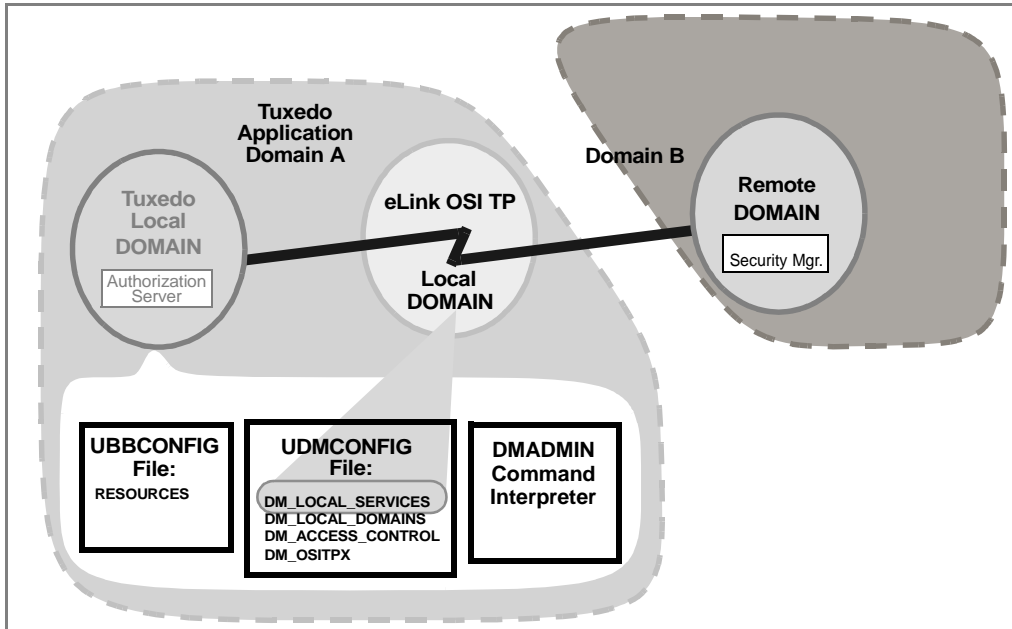

Enabling Link Layer Security

To enable security, both the local and remote domains must support security. For Link Layer Security (LLS), the administrator must define the `SECURITY` in the `*LOCAL_DOMAINS` section as `DM_PW` and the `OPTIONS` parameter in the `DM_OSITPX` section must be set to `SECURITY_SUPPORTED`. The Local and Remote domain passwords should be set by the administrator through the `dmadmin` command `passwd`.

Whenever Link Layer Security is defined for the local domain and the remote domain, the `passwd` entered through `dmadmin` is hashed with a private key. The hashed value and private key are sent to the remote domain where it is compared with the hashed `passwd` on the remote system. This is a challenge response mechanism used to secure connections with a remote domain.

Three sections in the `DMCONFIG` file contain parameters affecting how eLink OSI TP controls access to the local Tuxedo domain:

- `DM_LOCAL_DOMAINS` section contains a `SECURITY` parameter that specifies the type of security enforced for the Tuxedo local domain.

The `SECURITY` parameter settings in this section work in conjunction with the `SECURITY` parameter in the `RESOURCES` section of the Tuxedo domain's `UBBCONFIG` file to establish how eLink OSI TP controls access to the Tuxedo local domain. If this parameter is set to `NONE` or `APP_PW`, the eLink OSI TP domain takes no action with regard to security. If this parameter is set to `DM_PW`, the eLink OSI TP domain enforces security according to the security settings in the `DM_PASSWORDS` section of the `BDMCONFIG` file.

Caution: Do not delete the Tuxedo `BDMCONFIG` file. The `DM_PW` information will be lost if the file is deleted. When new passwords are entered, the `GWOSITP` service must be shut down and restarted for the passwords to take effect.

- `DM_REMOTE_DOMAINS` section contains an `OPTIONS=SECURITY_SUPPORTED` parameter that specifies the type of security enforced for the Tuxedo remote domain.
- `DM_OSITPX` section contains an `OPTION` of `SECURITY_SUPPORTED`, which indicates that the remote domain supports the OSI TP security extension. The OSI TP security extension allows OSI TP systems to perform link-layer security. The link layer security feature is activated when the `DM_LOCAL_DOMAINS` section has `SECURITY=DM_PW` set and `OPTIONS=SECURITY_SUPPORTED` is set for the remote domain.

Refer to [“Enabling Tuxedo Authentication”](#) for more information about Tuxedo security.

The following sample is a `DMCONFIG` file that defines the necessary parameters for establishing Link Layer Security.

Listing 4-9 Sample `DMCONFIG` File for Establishing Link Layer Security

```
#-----  
# eLink OSI TP test; Client dmconfig  
#-----  
#  
*DM_LOCAL_DOMAINS  
  
dalnt8  
GWGRP=G3  
TYPE=OSITPX
```

```

DOMAINID="dalnt8"
BLOCKTIME=30
MAXDATALEN=56
DMTLOGDEV="D:\tuxedo\log\DMLOG"
SECURITY=DM_PW          # turns link layer security on
DMTLOGNAME="DMLOG"

#####
*DM_REMOTE_DOMAINS
dal2200      TYPE=OSITPX      DOMAINID=dal2200 ACL_POLICY=GLOBAL
openti      TYPE=OSITPX      DOMAINID=openti  ACL_POLICY=GLOBAL
icl2        TYPE=OSITPX      DOMAINID=icl2
aseries     TYPE=OSITPX      DOMAINID="aseries1" ACL_POLICY=LOCAL
              LOCAL_PRINCIPAL_NAME="MYNAME"

*DM_OSITPX

dalnt8
AET="{1.3.132.61.146},{3}"
TAILOR_PATH="D:\tuxedo\configs\tailor.txt"
NWADDR="//dalnt8:102"
DNS_RESOLUTION=STARTUP # This is the default

# Remote domain dal2200 supports security
dal2200
AET="{1.3.132.61.46},{3}"
XATMI_ENCODING="OLTP_TM2200"
NWADDR="132.61.146.3"
T_SEL="OSITP"
OPTIONS=SECURITY_SUPPORTED

# Remote domain openti supports security
openti
AET="{1.3.122.62.103},{209}"
NWADDR="122.62.103.209:2001"
OPTIONS=SECURITY_SUPPORTED

# Remote domain icl12 does not support security
icl2
AET="{1.3.142.60.203},{4}"
NWADDR="142.60.203.4"
T_SEL="ICLTP"
S_SEL="SSEL"
P_SEL="PSEL"

# Remote domain aseries1 does not support security
# DOMAINID "aseries1" shall be used as LOCALPRINCIPAL NAME
aseries1
AET="{1.3.123.55.222},{51}"

```

4 Configuring BEA eLink OSI TP

```
NWADDR="123.55.222.51"
XATMI_ENCODING="PRELIMINARY"
T_SEL="0x5453"
S_SEL="0x3F5C3F"

*DM_LOCAL_SERVICES
TOUPPERF
    INRECTYPE="VIEW:V10"
    OUTBUFTYPE="FML:"
    COUPLING=LOOSE

TOUPPERF32
    INRECTYPE="VIEW:V10"
    OUTBUFTYPE="FML32:"
    COUPLING=TIGHT

TOUPPERV
    INBUFTYPE="X_C_TYPE:V10"
    INRECTYPE="VIEW:upper"
    COUPLING=LOOSE

TOUPPERC
    INRECTYPE="X_OCTET"
    COUPLING=TIGHT

TOUPPERS
    OUTRECTYPE="X_OCTET"
    OUTBUFTYPE="STRING"
    INRECTYPE="X_OCTET"

TOUPPERX
    OUTRECTYPE="STRING"
    OUTBUFTYPE="STRING"
    INRECTYPE="X_OCTET"

*DM_REMOTE_SERVICES
DEFAULT: TRANTIME=300

ECHOXOCT RNAME="ECHOSRVR"
    OUTBUFTYPE="X_COMMON:ECHOVIEW"
    RDOM=dal2200
    LDOM=dalnt8

ECHOXCOM RNAME="ECHOSRVR"
    RDOM=openti
    LDOM=dalnt8
    AUTOPREPARE=Y

ECHOTYPE
    RNAME="ECHOSRVR"
```



```

INBUFTYPE="X_C_TYPE:ECHOVIEW"
INRECTYPE="X_C_TYPE:ECHOVIEW"
OUTBUFTYPE="X_C_TYPE:ECHOVIEW"
OUTRECTYPE="X_C_TYPE:ECHOVIEW"

ECHOVIEW

RNAME="ECHOSVR"
INBUFTYPE="VIEW:ECHOVIEW"
INRECTYPE="X_COMMON:ECHOVIEW"
OUTBUFTYPE="VIEW:ECHOVIEW"
OUTRECTYPE="X_COMMON:ECHOVIEW"
RDOM=icl2
LDOM=dalnt8
TPSUT_TYPE="PRINTABLESTRING"
REM_TPSUT="tpmvs"

```

Enabling Tuxedo Authentication

BEA eLink OSI TP gateway supports Tuxedo authentication and authorization at both the client side (for Tuxedo clients) and server side. Authentication and authorization at the client side works the same as /T domains. Authentication and authorization on the server side requires that the Link Layer Security, described previously, is configured for both the LOCAL DOMAIN and the REMOTE DOMAIN involved in the service call.

In order for user authentication at the server side domain to be performed, the SECURITY parameter defined in the servers local domain *RESOURCE section must be defined as either "APP_PW", "USER_AUTH", "ACL", or "MANDATORY_ACL".

When SECURITY is set to either "APP_PW" or "USER_AUTH", user authentication is performed. If the ACL_POLICY for the remote domain from which the call was issued is defined as LOCAL, then the user ID used for authentication will be the LOCAL_PRINCIPAL_NAME of the remote domain if it has been defined. If the LOCAL_PRINCIPAL_NAME has not been defined, then the user ID will be the DOMAINID of the remote domain. If the ACL_POLICY for the remote domain from which the call was issued is defined as GLOBAL, then the userid passed with the call is used for user authentication. The user ID is authenticated against the user IDs defined in the tpusr file.

When SECURITY is set to "ACL", then user authentication is performed as previously defined for "APP_PW" and "USER_AUTH". User authorization of the service, requested in the call, is also performed. ACL authorization requires that the services have been

defined in the ACL Service list and that the user be a member of a group that is allowed access to this service. Services are added to the ACL Service list through the `tpacladd` command. If the requested service has not been added to the ACL Service list, then all users are allowed access to this service.

When `SECURITY` is set to "MANDATORY_ACL" authentication and authorization are performed identical to that for `SECURITY` equal "ACL", however, the request service must be defined in the ACL Service list and the users group must be allowed access to this service.

For more information regarding Tuxedo commands `tpgrpadd`, `tpusradd`, `tpacladd`, `tpgrpmod`, `tpusrmod`, `tpaclmod`, `tpgrpdel`, `tpasrdel`, and `tpacldel`, refer to the online BEA Tuxedo documentation at <http://edocs.bea.com/tuxedo/tux80/index.htm>.

The following sample shows a `UBBCONFIG` file. The example defines the necessary parameters for establishing Link Layer Security.

Listing 4-10 Sample UBBCONFIG File Showing Security Set to MANDATORY_ACL.

```
#-----  
# eLink OSI TP test ubbconfig for servers  
#-----  
*RESOURCES  
#-----  
Chnage IPCKEY  
#-----  
IPCKEY          52029  
MASTER          SITE1  
DOMAINID        FRONTEND  
PERM             0660  
MAXACCESSSERS   40  
MAXSERVERS      80  
MAXSERVICES     80  
MAXCONV         120  
MODEL           SHM  
LDBAL           Y  
MAXGTT          120  
MAXBUFTYPE     16  
MAXBUFSTYPE    32  
SCANUNIT       5  
SANITYSCAN     10  
DBLWAIT        5  
BBLQUERY       50  
BLOCKTIME      15
```

```

SECURITY          MANDATORY_ACL
#
*MACHINES
#-----
#Replace machine name
#-----

DALNT45          LMID=SITE1
#-----
# Replace directories as needed
#-----
                TUXDIR="c:\tuxedo"
                APPDIR="c:\ositp/test
                TUXCONFIG="c:\tuxedo/udataobj\tuxconfig"
                TLOGDEVICE="c:\ositp\test\TLOG
                TLOGNAME=TLOG

*GROUPS
OSIGRP2          GRPNO=2  LMID=SITE1  TMSNAME="TMS"  TMSCOUNT=2
OSIGRP2          GRPNO=3  LMID=SITE1

*SERVERS
DEFAULT:RESTART=N  REPLYQ=Y
DMADM    SRVID=101  SRVGRP=OSIGRP3  CLOPT="-A"  REPLYQ=N
GWADM    SRVID=102  SRVGRP=OSIGRP3  CLOPT="-A"  REPLYQ=N
GWOSITP  SRVID=103  SRVGRP=OSIGRP3  CLOPT="-A"  GRACE=0  REPLYQ=N
CRPCSERV SRVID=8    SRVGRP=OSIGRP3  CLOPT="-A"  RQADDR="rpcq"
CCONSRV  SRVID=9    SRVGRP=OSIGRP3  CLOPT="-A"  RQADDR="convq"
                CONV=Y

*SERVICES
DEFAULT          LOAD=50  AUTOTRAN=n
CTOUPPER         PRIO=50
CCONVRTN         PRIO=50
CCONVRTN2        PRIO=50
CCONVRTN3        PRIO=50
CTOUPPER2        PRIO=50

```

The following sample shows a DMCONFIG file. The example defines the necessary parameters for user authentication and authorization.

Listing 4-11 Sample DMCONFIG File Showing LLS set and ACL_POLICY of LOCAL

```
#-----
eLink OSI TP Test; Client dmconfig
#-----

#
*DM_LOCAL DOMAINS

dalnt8
GWGRP=G3
TYPE=OSITPX
DOMAINID="dalnt8"
BLOCKTIME=30
MAXDATALEN=56
DMTLOGDEV="D:\tuxedo\log\DMLOG"
DMTLOGNAME="DMLOG"
SECURITY=DM_PW          # turns link layer security on

#####
*DM_REMOTE_DOMAINS
DAL2200      TYPE=OSITPX  DOMAINID=DAL2200  ACL_POLICY=LOCAL

openti      TYPE=OSITPX  DOMAINID=openti   ACL_POLICY=GLOBAL

icl2        TYPE=OSITPX  DOMAINID=icl2
aseries     TYPE=OSITPX  DOMAINID="aseries1"

*DM_OSITPX

dalnt8
      AET="{1.3.132.61.146},{3}"
      TAILOR_PATH="d:\tuxedo\configs\tailor.txt"
      NWADDR="//dalnt8:102"
      DNS_RESOLUTION=STARTUP # This is the default

# Remote domain dal2200 supports security
dal2200
      AET="{1.3.132.61.47},{3}"
      XATMI_ENCODING="OLTP_TM2200"
      NWADDR="132.61.47.3"
      T_SEL="OSITP"
      OPTIONS=SECURITY_SUPPORTED

# Remote domain openti supports security
openti
      AET="{1.3.122.62.103},{209}"
      NWADDR="122.62.103.209:2001"
      OPTIONS=SECURITY_SUPPORTED
```

```

# Remote domain icl2 does not support security
icl2
    AET="{1.3.142.60.203},{4}"
    NWADDR="142.60.203.4"
    T_SEL="ICLTP"
    S_SEL="SSEL"
    P_SEL="PSEL"

# Remote domain aseries1 does not support security
aseries1
    AET="{1.3.123.55.222},{51}"
    NWADDR="123.55.222.51"
    XATMI_ENCODING="PRELIMINARY"
    T_SEL="0X5453"
    S_SEL="0X3F5C3F"

*DM_LOCAL_SERVICES
TOUPPERF
    INRECTYPE="VIEW:view10"
    OUTBUFTYPE="FML:"
    COUPLING=LOOSE

TOUPPERF32
    INRECTYPE="VIEW:view10"
    OUTBUFTYPE="fml32"
    COUPLING=TIGHT

TOUPPERV
    INBUFTYPE="X_C_TYPE:v10"
    INRECTYPE="VIEW:upper"
    COUPLING=LOOSE

TOUPPERC
    INRECTYPE="X_OCTET"
    COUPLING=TIGHT

TOUPPERS
    OUTRECTYPE="X_OCTET"
    OUTBUFTYPE="STRING"
    INRECTYPE="X_OCTET"

TOUPPERX
    OUTRECTYPE="STRING"
    OUTBUFTYPE="STRING"
    INRECTYPE="X_OCTET"

*DM_REMOTE_SERVICES
DEFAULT:  TRANTIME=300

```

```
ECHOXOCT
    RNAME=" ECHOSRVR "
    OUTBUFTYPE=" X_COMMON : ECHOVIEW "
    RDOM=dal2200
    LDOM=dalnt8

ECHOXCOM
    RNAME=" ECHOSRVR "
    RDOM=openti
    LDOM=dalnt8
    AUTOPREPARE=Y

ECHOTYPE
    RNAME=" ECHOSRVR "
    INBUFTYPE=" X_C_TYPE : ECHOVIEW "
    INRECTYPE=" X_C_TYPE : ECHOVIEW "
    OUTBUFTYPE=" X_C_TYPE : ECHOVIEW "
    OUTRECTYPE=" X_C_TYPE : ECHOVIEW "

ECHOVIEW
    RNAME=" ECHOSRVR "
    INBUFTYPE=" VIEW : ECHOVIEW "
    INRECTYPE=" X_COMMON : ECHOVIEW "
    OUTBUFTYPE=" VIEW : ECHOVIEW "
    OUTRECTYPE=" X_COMMON : ECHOVIEW "
    RDOM=icl2
    LDOM=dalnt8
    TPSUT_TYPE=" PRINTABLESTRING "
    REM_TPSUT=" tpmvs "
```

Implementing Native-A Encoding

The Native-A encoding feature in eLink OSI TP converts Tuxedo views into a format that is native to Unisys MCP mainframe systems. This feature moves most of the encode/decode processing from the Unisys MCP mainframe systems to the Tuxedo system.

Using the XATMI_ENCODING Type

Currently, the type of XATMI encoding must be configured for each RDOM using the XATMI_ENCODING parameter in the DM_OSITPX section of the DMCONFIG file. An XATMI_ENCODING keyword value of NATIVE_A_SERIES is used to indicate that the Tuxedo system will handle the encode/decode of data into the Native MCP format, not the Unisys MCP machine.

The following example is a *DM_OSITPX section of the DMCONFIG file.

```
*DM_OSITPX
aseries1
    AET="{1.3.123.55.22},{51}"
    NWADDR="123.55.22.51"
    XATMI_ENCODING="NATIVE_A_SERIES"
    T_SEL="0x5453"
    S_SEL="0x3F5C3F"
```

Using the CODEPAGE Parameter

There is an optional CODEPAGE parameter on the RDOM statement in the DM_REMOTE_DOMAINS section of the DMCONFIG file. The CODEPAGE parameter is configured to specify the pair of code sets involved when translating character strings between the Tuxedo system and the MCP (A-Series) system. If XATMI_ENCODING is not set to NATIVE_A_SERIES, then the CODEPAGE parameter is ignored.

The syntax is shown below:

```
*DM_REMOTE_DOMAINS
...
rdom TYPE=OSITPX DOMAINID="domainid" CODEPAGE="cpname"
```

Where *cpname* is a case-insensitive keyword from the following table:

cpname keyword	ISO Character Set	MCP Character Set
Tuxedo	ASCII	ASERIESEBCDIC
88591xL1EBC	ISO 8859-1 (Latin-1)	Latin1EBCDIC
88592xL2EBC	ISO 8859-2 (Latin-2)	Latin2EBCDIC
88599xL5EBC	ISO 8859-9 (Latin-5)	Latin5EBCDIC
885915xL9EBC	ISO 8859-15 (Latin-9)	Latin9EBCDIC

88595xLCYEBC	ISO 8859-5 (Latin Cyrillic)	LatinCyrillicEBC
88597xLGREBC	ISO 8859-7 (Latin Greek)	LatinGreekEBCDIC
88591xIBMSEBC	ISO 8859-1 (Latin1)	IBMSwedenEBCDIC
AR20xAR20EBC	Arabic20ISO	Arabic20EBCDIC

Rules for Viewfile Character Types

If `XATMI_ENCODING` is not set to `NATIVE_A_SERIES`, then no conversion of character strings occurs. If `XATMI_ENCODING` is set to `NATIVE_A_SERIES`, then conversions occur according to the rules described in the following subsections.

Rules for Type string

All view fields of type `string` must be null-terminated on both the Tuxedo and `NATIVE_A_SERIES` encoding feature, `string` fields may contain any non-zero bytes, followed by a zero byte as a null-terminator.

All view fields of type `string` are always translated from the ISO character set to the MCP character set (as specified by the `CODEPAGE` parameter) when passing from the Tuxedo system to the MCP system. The input string must be null-terminated; any bytes after the null-terminator are ignored. The resulting string on the Unisys MCP system is null-terminated; any remaining space in the field is also padded with zero bytes.

Conversly, all view fields of type `string` are translated from the MCP character set to the ISO character set (as specified by the `CODEPAGE` parameter) when passing from the Unisys MCP system to the Tuxedo system. The input string must be null-terminated; any bytes after the null-terminator are ignored. The resulting string on the Tuxedo system is null-terminated; any remaining space in the field is also padded with zero bytes.

Rules for Type carray

View fields of type `carray` need not be null-terminated. `Carray` fields may contain any non-zero bytes; if a zero byte is detected, it is treated as a null-terminator and scanning stops.

All view fields of type `carray` are always translated from the ISO character set to the MCP character set (as specified by the `CODEPAGE` parameter) when passing from the Tuxedo system to the Unisys MCP system. The input string may or may not be null-terminated; any bytes after a null-terminator are ignored. The resulting string on the MCP system is not null-terminated; any remaining space in the field is padded with EBCDIC space characters (0x40 bytes).

Conversly, all view fields of type `carray` are translated from the MCP character set to the ISO character set (as specified in the `CODEPAGE` parameter) when passing from the Tuxedo system to the Unisys MCP system. The input string may or may not be null-terminated; any bytes after a null-terminator are ignored. If the input string is not null-terminated, then any trailing EBCDIC space characters (0x40 bytes) are discarded before translation starts. The resulting string on the Tuxedo system is null-terminated if there is room; any remaining space in the field is also padded with zero bytes.

For existing users who plan to use the Native-A feature, it is important to note that fields of type `carray` are always translated. If you wish to transmit binary data that should not be translated, then you must change your view field type from `carray` to an array of type `char`.

Rules for Type `char`

View fields of type `char` may contain any arbitrary binary data. View fields of type `char` are never translated.

For existing users who plan to use the Native-A feature, it is important to note that fields of type `char` are never translated. If you want to have fields of type `char` translated, you need to change your view field type from `char` to `carray`. See the following example.

Listing 4-12 Example of `char` Field Changed to `carray`

```
VIEW viewx
#
#type   cname          fdbname  count  flag   size  null
#
int     accountNum    -        1      -      -      -
string  firstName     -        1      -      20    -
# Change middleInit from char to carray so it is translated
# char  middleInit    -        1      -      -      -
carray  middleInit    -        1      -      1      -
```

```
string laststName - 1 - 20 -  
END
```

Conversly, you may wish to change other data types (e.g., `carray`) to type `char` to prevent them from being translated. See the following example:

Listing 4-13 Example of `carray` Field Changed to `char`

```
VIEW viewy  
#  
#type cname fbname count flag size null  
#  
int accountNum - 1 - - -  
string name - 1 - 50 -  
#Change encryptKey from carray to char so it is not  
#translated:  
#carray encryptKey - 1 - 15 -  
char encryptKey - 15 - - -  
END
```

Editing the DMCONFIG File

If you are upgrading from eLink OSI TP 1.3, it is recommended that you use the `osiadmin` utility to update your `DMCONFIG` file; however, you may edit the `DMCONFIG` file manually. If you are upgrading from eLink OSI TP 4.0 or 4.1, you do not need to change your `udmconfig` input file. You can use it as input to the eLink OSI TP 4.2 `dmloadcf` utility. Refer to Using the OSI TP Administration Utility for more information about the `osiadmin` utility.

To edit the `DMCONFIG` file manually, perform the following steps:

1. Find the `DMCONFIG` file in your installation directory and open it in any text editor.
2. Edit the `DMCONFIG` file as necessary. Refer to the parameter descriptions in this section for details about defining your eLink OSI TP configuration.

3. When editing is complete, save the DMCONFIG file.

Note: You may want to save the original DMCONFIG file with a different name or in a different directory.

4. Process the DMCONFIG file with the `dmloadcf` utility. This parses the input and creates a binary file: the BDMCONFIG file, which is used by GWOSITP. Refer to [Understanding the DMCONFIG File](#) for more detailed information about the parameters in the DMCONFIG file.

Steps for Modifying the DMCONFIG File Parameters

Perform the following steps to modify the DMCONFIG file parameters:

- Step 1 - Define Local Domains
- Step 2 - Define Remote Domains
- Step 3 - Specify Addressing Information for OSI TP Domains
- Step 4 - Specify Access Control for OSI TP Domains
- Step 5 - Specify Available Local Tuxedo Services
- Step 6 - Specify Available Remote Tuxedo Services
- Step 7 - Specify Routing Information

Step 1 - Define Local Domains

You must define the local domains that use the OSI TP server group you defined in your Tuxedo UBBCONFIG file. Refer to [Defining eLink OSI TP Servers for BEA Tuxedo](#) for more information about the UBBCONFIG file.

Perform the following steps to define a local domain in the `DM_LOCAL_DOMAINS` section of the DMCONFIG file:

1. Specify the local domain ID with the `DOMAINID` parameter.
2. Specify the gateway group you defined in the UBBCONFIG file with the `GWGRP` parameter.

3. Specify the domain type of OSITPX with the `TYPE` parameter.
4. Specify the size of the domain transaction log with the `DMTLOGSIZE` parameter.
5. Specify any of the optional `DM_LOCAL_DOMAINS` parameters that you require: `AUDITLOG`, `BLOCKTIME`, `DMTLOGDEV`, `DMTLOGNAME`, `MAXRDTRAN`, `MAXTRAN`, and `SECURITY`.

Listing 4-14 Example of `DM_LOCAL_DOMAINS` Section

```
*DM_LOCAL_DOMAINS

dalnt8
GWGRP      = OSIGRP
TYPE       = OSITPX
DOMAINID   = "dalnt8"
BLOCKTIME  = 30
DMTLOGDEV  = "D:\tuxedo\log\DMLOG"
DMTLOGNAME = "DMLOG"
SECURITY   = DM_PW # turns link layer security on
```

Refer to Sample Configuration File for more detailed information.

Step 2 - Define Remote Domains

It is recommended that you use the `importcfg` command in the `osiadmin` utility to update remote domains if you are upgrading from BEA eLink OSI TP 1.3; however, you can manually define remote domains. Refer to *Using the OSI TP Administration Utility* for more information about the `osiadmin` utility.

Perform the following steps to define remote domains in the `DM_REMOTE_DOMAINS` section of the `DMCONFIG` file:

1. Specify the remote domain ID with the `DOMAINID` parameter.
2. Specify the `OSITPX` domain type with the `TYPE` parameter.

There are no optional parameters for the `DM_REMOTE_DOMAINS` section.

Listing 4-15 Example of DM_REMOTE_DOMAINS Section

```
*DM_REMOTE_DOMAINS

dal2200 TYPE=OSITPX DOMAINID="dal2200"
openti TYPE=OSITPX DOMAINID="openti"
icl2 TYPE=OSITPX DOMAINID="icl2"
aseries1 TYPE=OSITPX DOMAINID="aseries1"
```

Refer to DM_REMOTE_DOMAINS Section for more detailed information.

Step 3 - Specify Addressing Information for OSI TP Domains

Perform the following steps to define addressing information for OSI TP domains in the DM_OSITPX section of the DMCONFIG file:

1. Specify the Application Entity Title for each local and remote OSI TP domain with the AET parameter.
2. Specify the IP address or DNS name and port number for each local and remote OSI TP domain with the NWADDR parameter. If you are using multiple IP addresses, make sure to enter all the addresses on one line, and separate them with a semi-colon (;). Put double quotes around the entire address.
3. Specify any of the optional DM_OSITPX parameters that you require: DNS_RESOLUTION, P_SEL, S_SEL, T_SEL, OPTIONS, TAILOR_PATH, and XATMI_ENCODING.

Listing 4-16 DM_OSITPX Section

```
*DM_OSITPX

dalnt8
    AET="{1.3.144.23.103},{208}"
    TAILOR_PATH="d:\tuxedo\configs\tailor.txt"
    NWADDR="//dalnt8:102"
    DNS_RESOLUTION=STARTUP # this is the default

dal2200
    AET="{1.3.132.61.146},{3}"
    XATMI_ENCODING="OLTP_TM2200"
```

4 Configuring BEA eLink OSI TP

```
NWADDR="132.61.146.3;132.61.147.1"
T_SEL="OSITP"

openti
AET="{1.3.122.62.103},{209}"
NWADDR="122.62.103.209"

icl2
AET="{1.3.142.60.203},{4}"
NWADDR="142.60.203.4"
T_SEL="ICLTP"
S_SEL="SSEL"
P_SEL="PSEL"

aseries1
AET="{1.3.123.55.222},{51}"
NWADDR="123.55.222.51"
XATMI_ENCODING="PRELIMINARY"
T_SEL="0x5453"
S_SEL="0x3F5C3F"
OPTIONS=SECURITY_SUPPORTED
```

Refer to DM_OSITPX Section for more detailed information.

Step 4 - Specify Access Control for OSI TP Domains

In the DM_ACCESS_CONTROL section of the DMCONFIG file, specify a list of all the remote OSI TP domain IDs that can access the local domain with the ACLIST parameter. This parameter is optional.

Listing 4-17 Example of DM_ACCESS_CONTROL Section

```
*DM_ACCESS_CONTROL
mylist ACLIST = dalnt8, dal2200
```

Refer to DM_ACCESS CONTROL Section for more detailed information.

Step 5 - Specify Available Local Tuxedo Services

In the `DM_LOCAL_SERVICES` section of the `DMCONFIG` file, specify the Tuxedo services that will be made available to OSI TP applications and define their options with the `ACL`, `COUPLING`, `INBUFTYPE`, `INRECTYPE`, `LDOM`, `OUTBUFTYPE`, `OUTRECTYPE`, and `RNAME` parameters. If the local service supports transactions, make sure the group it belongs to contains a TMS name.

These `DM_LOCAL_SERVICES` parameters are all optional.

Listing 4-18 Example of DM_LOCAL_SERVICES Section

```
*DM_LOCAL_SERVICES
TOUPPERF
    INRECTYPE="VIEW:view10"
    OUTBUFTYPE="FML:"
    COUPLING=LOOSE

TOUPPERF32
    INRECTYPE="VIEW:view10a"
    OUTBUFTYPE="FML32:"
    COUPLING=TIGHT

TOUPPERV
    INBUFTYPE="X_C_TYPE:v10"
    INRECTYPE="VIEW:upper"
    COUPLING=LOOSE

TOUPPERC OUTRECTYPE="X_OCTET" OUTBUFTYPE="CARRY"
    INRECTYPE="X_OCTET"
    COUPLING=TIGHT

TOUPPERS OUTRECTYPE="X_OCTET" OUTBUFTYPE="STRING"
    INRECTYPE="X_OCTET"

TOUPPERX OUTRECTYPE="STRING" OUTBUFTYPE="STRING"
    INRECTYPE="X_OCTET"
```

Refer to `DM_LOCAL_SERVICES` Section for more detailed information.

Step 6 - Specify Available Remote Tuxedo Services

In the `DM_REMOTE_SERVICES` section of the `DMCONFIG` file, specify the remote services that can be requested by Tuxedo applications and define their options with the `AUTOPREPARE`, `CODEPAGE`, `CONV`, `INBUFTYPE`, `INRECTYPE`, `LDOM`, `OUTBUFTYPE`, `OUTRECTYPE`, `RDOM`, `RNAME`, `ROUTING`, and `TRANTIME` parameters. These parameters are all optional.

Listing 4-19 Example of `DM_REMOTE_SERVICES` Section

```
*DM_REMOTE_SERVICES
DEFAULT: TRANTIME=300

ECHOXOCT RNAME="ECHOSRVR" OUTBUFTYPE="X_COMMON:ECHOVIEW"
RDOM=dal2200 LDOM=dalnt8
ECHOXCOM RNAME="ECHOSRVR" RDOM=openti LDOM=dalnt8 AUTOPREPARE=Y

ECHOXCTYPE RNAME="ECHOSRVR"
    INBUFTYPE="X_C_TYPE:ECHOVIEW"
    INRECTYPE="X_COMMON:ECHOVIEW"
    OUTBUFTYPE="X_C_TYPE:ECHOVIEW"
    OUTRECTYPE="X_COMMON:ECHOVIEW"
    RDOM=aseries1
    LDOM=dalnt8
    CONV=Y
ECHOVIEW RNAME="ECHOSRVR"
    INBUFTYPE="VIEW:ECHOVIEW"
    INRECTYPE="X_COMMON:ECHOVIEW"
    OUTBUFTYPE="VIEW:ECHOVIEW"
    OUTRECTYPE="X_COMMON:ECHOVIEW"
    RDOM=icl2
    LDOM=dalnt8
    TPSUT_TYPE="PRINTABLESTRING"
    REM_TPSUT="tpmvs"
```

Refer to `DM_REMOTE_SERVICES` Section for more detailed information.

Step 7 - Specify Routing Information

Perform the following steps to define routing information for service requests in the `DM_ROUTING` section of the `DMCONFIG` file:

1. Specify the name of the routing field with the `FIELD` parameter.
2. Specify the data buffer type and subtype for which the routing entry is valid with the `BUFTYPE` parameter.
3. Specify the ranges and associated remote domain names for the routing field with the `RANGES` parameter.

Listing 4-20 Example of DM_ROUTING Section

```
*DM_ROUTING
ACCOUNT FIELD = branchid BUFTYPE = "View:account"
      RANGE = "MIN - 1000:aseries1, 1001-3000:openti, *:dal2200"
```

Refer to DM_ROUTING Section for more detailed information.

Processing a Configuration File with the `dmloadcf` Utility

The `dmloadcf` utility compiles the `DMCONFIG` file and creates a binary configuration file, `BDMCONFIG`, which is used by the `DMADM` server to control the run-time environment.

[Figure 4-3](#) shows how the `dmloadcf` utility processes the configuration file. A description of the process follows the figure.

Figure 4-3 dmloadcf Process

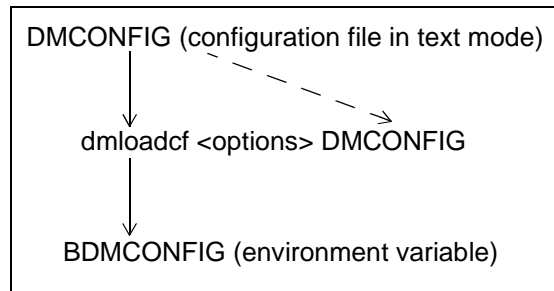

Invoking the dmloadcf Utility

The `dmloadcf` utility is invoked from a command line with the following syntax:

```
dmloadcf [-c] [-n] [-y] [-b blocks] [-k] DMCONFIG_file
```

where the following options are valid:

- c
Prints minimum IPC resources needed for each local domain (gateway group) in this configuration. The `BDMCONFIG` file is not updated.
- n
Checks only the syntax of the ASCII `DMCONFIG` file without actually updating the `BDMCONFIG` file.
- y
Suppresses a prompt to create and initialize the `BDMCONFIG` file. This parameter **must** be entered before the `DMCONFIG` file name.
- b *blocks*
Indicates the number of blocks the device should use to create the Tuxedo file system. If the value of the `-b` option is large enough to hold the new `BDMCONFIG` tables, `dmloadcf` uses the specified value to create the new file system; otherwise, `dmloadcf` prints an error message and exits. If the `-b` option is not specified, `dmloadcf` creates a new file system large enough to hold the `BDMCONFIG` tables. The `-b` option is ignored if the file system already exists. The `-b` option is highly recommended if `BDMCONFIG` is a raw device

(that has not been initialized) and should be set to the number of blocks on the raw device.

`dmconfig_file`

Specifies the name of the input configuration file to `dmloadcf`.

How the `dmloadcf` Utility Works

The `dmloadcf` utility prints an error message if any required section of the `DMCONFIG` file is missing. If a syntax error is found while parsing the input file, `dmloadcf` exits without performing any updates to the `BDMCONFIG` file.

A Tuxedo `DMTYPE` file is required to define the valid domain types. If this file does not exist, `dmloadcf` exits without performing any updates to the `BDMCONFIG` file.

The effective user ID of the person running `dmloadcf` must match the `UID` in the `RESOURCES` section of the `TUXCONFIG` file.

After syntax checking, `dmloadcf` verifies that the file pointed to by `BDMCONFIG` exists, is a valid Tuxedo System file system, and contains `BDMCONFIG` tables. If these conditions are not true and the `-y` option was not entered on the command line, the user is prompted to create and initialize the file with

```
Initialize BDMCONFIG file: path {y, q}?
```

where *path* is the complete file name of the `BDMCONFIG` file and “y” indicates that the configuration file should be created.

If the `BDMCONFIG` file is determined to already have been initialized, `dmloadcf` ensures that the local domain described by that `BDMCONFIG` file is not running. If a local domain is running, `dmloadcf` prints an error message and exits. Otherwise, `dmloadcf` confirms that the file should be overwritten by prompting the user with:

```
“Really overwrite BDMCONFIG file {y, q}?”
```

Prompting is suppressed if the standard input or output are not terminals. Any response other than “y” or “Y” causes `dmloadcf` to exit without creating the configuration file. If the `BDMCONFIG` file is not properly initialized and the user has responded with “Y”, `dmloadcf` creates the Tuxedo file system and then creates the `BDMCONFIG` tables.

If the `SECURITY` parameter is specified in the `RESOURCES` section of the `TUXCONFIG` file, then `dmloadcf` flushes the standard input, turns off terminal echo, and prompts the user for an application password.

Assuming no errors, and if all checks have passed, `dmloadcf` loads the `DMCONFIG` file into the `BDMCONFIG` file and overwrites all existing information found in the `BDMCONFIG` tables.

The following example shows how a binary configuration file is loaded from the `bank.DMCONFIG` ASCII file. The `BDMCONFIG` device is created (or reinitialized) with 2000 blocks:

```
dmloadcf -b 2000 -y bank.dmconfig
```

Diagnostics

If an error is detected in the input, the erroneous line is printed to the standard error log along with a message indicating the problem. If a syntax error is found in the `DMCONFIG` file or the system is currently running, no information is updated in the `BDMCONFIG` file and `dmloadcf` exits.

If `dmloadcf` is run on an active node, the following error message is displayed:

```
*** dmloadcf cannot run on an active node ***
```

If `dmloadcf` is run by a person whose effective user ID doesn't match the `UID` specified in the `TUXCONFIG` file, the following error message is displayed:

```
*** UID is not effective user ID ***
```

Upon successful completion, `dmloadcf` exits. If the `BDMCONFIG` file is updated, a `userlog` message is generated to record this event.

Tuning OSI TP-Specific Tables with the TAILOR File

The OSI TP `TAILOR` file is external to the `DMCONFIG` and is used for tuning OSI TP-specific tables. All parameters in the `TAILOR` file are optional with preset defaults.

Following is a list of valid TAILOR parameters:

Parameter	Default	Description
* FreeOldRetryTime	600 seconds	Time in seconds between automatic terminations of old connections
MaxConnections	500	Maximum size of various internal tables
** KeepAliveCheck	60	Time in seconds of connection inactivity before a keepalive packet is sent on the connection.
** KeepAliveTimeout	10	Time in seconds to wait for an acknowledgement message when a keepalive packet is sent. If this timeout is exceeded, then the connection is re-established.
MaxRemoteNodes	1000	Maximum number of total remote domains
* OldAssocTimeout	3600 seconds	Time in seconds denoting an "old" connection (association)
* RdomAssocRetry	60 seconds	Time in seconds between automatic retries of associations to unavailable RDOMS.
* TCPSocketsKeepAlives	N	Toggle for TCP keepalive packets
** StartFlowControlThreshold	1,048,576	Number of bytes of data which may be buffered to a particular RDOM before flow control is started.
** StopFlowControlThreshold	102,400	Number of bytes that the data buffered to the RDOM must fall below before flow control is relieved (when flow control is in effect.)

Parameter	Default	Description
TCPSocketsLinger	-1	Amount of time TCP/IP socket connection stays open
TCPSocketsListenQueueDepth	5	Number of held TCP/IP connections waiting to be accepted by eLink OSI TP
TCPSocketsNoDelay	N	Toggle to delay sends of TCP/IP packets until an ACK is received from remote machine
TraceIpKey	32800	IPC key value for the OSI TP log and trace shared memory section

Note: The parameters in the previous table with an asterisk (*) are valid for non-multiplexed connections only.

The parameters with double asterisks (**) apply only if you are using the multiplexing protocol.

Following is more detailed information about each of the TAILOR file parameters:

FreeOldRetryTimer = *numeric*

Specifies the time in seconds between automatic terminations of old connections (associations). OSI TP reuses established socket connections to a remote domain. The default value is 600 seconds.

Note: This parameter is valid for non-multiplexed connections only.

KeepAliveCheck = *numeric*

Specifies the time in seconds of connection inactivity before a keepalive packet is sent on the connection. The default value is 60 seconds.

Note: This parameter is only valid when using the multiplexing protocol.

KeepAliveTimeout = *numeric*

Specifies the amount of time in seconds to wait for an acknowledgement message when a keepalive packet is sent. If this timeout is exceeded, then the connection is re-established. The default is 10 seconds.

Note: This parameter is only valid when using the multiplexing protocol.

MaxConnections = *numeric*

Specifies the size of various internal tables. This value should be at least as large as the maximum number of total remote domains, including those added dynamically. The default value is 1000.

MaxRemoteNodes = *numeric*

Specifies the maximum number of total remote domains, including those added dynamically. The default value is 1000.

OldAssocTimeout = *numeric*

Specifies the time in seconds denoting an “old” connection (association). Any connection to a remote domain that remains unused by a `tpcall()` for this amount of time is subject to automatic termination. This default value is 3600 seconds.

Note: This parameter is valid for non-multiplexed connections only.

RdomAssocRetry = *numeric*

Specifies the time in seconds between automatic retries of associations to unavailable RDOMs. This value must be greater than zero. The default value is 60. This value may be overridden on each RDOM with the `EXTENSION` parameter and the `RdomAssocRetry` keyword.

Note: This parameter is valid for non-multiplexed connections only.

StartFlowControlThreshold = *numeric*

Specifies the number of bytes of data which may be buffered to a particular RDOM before flow control is started. When the data buffered to one particular RDOM exceeds this value, the services advertised for that RDOM/LDOM combination are suspended. The default value is 1,048,576 bytes.

Note: This parameter is only valid when using the multiplexing protocol.

StopFlowControlThreshold = *numeric*

Specifies the number of bytes that the data buffered to the RDOM must fall below before flow control is relieved (when flow control is in effect.) When buffering drops below this value for one particular RDOM, the services for that RDOM/LDOM combination are advertised again. The default value is 102,400 bytes.

Note: This parameter is only valid when using the multiplexing protocol.

TCPSocketsKeepAlives = {Y | N}

Specifies whether the TCP keepalive packets are sent. This is useful to insure the integrity of the TCP connection. If Y is specified the TCP/IP packets are sent out in a time period specified by the operating system. Most operating systems use a 2 hour time period. The default is N.

Note: This parameter is valid for non-multiplexed connections only.

TCPSocketsLinger = {-1 | 0 | *numeric*}

Specifies the amount of the time that the TCP/IP socket connection will stay open. This can be used to timeout hung connections.

Possible values are:

-1 (default)	Time that a TCP/IP socket connection stays in the TIME_WAIT state is determined by the operating system.
0	TCP/IP connection is closed immediately.
n	TCP/IP connection stays in the TIME_WAIT state for n seconds before closing.

TCPSocketsListenQueueDepth = *numeric*

Specifies the number of held TCP/IP connections waiting to be accepted by eLink OSI TP.

Possible values are:

5 (default)	A minimum of 5 incoming TCP/IP connections are held.
>5	More than 5 incoming TCP/IP connections are held. The operating system may only supports a number up to a “reasonable value”.

TCPSocketsNoDelay = {Y | N}

Specifies if subsequent sends of TCP/IP packets are held until an ACK is received from a remote machine. The default is N, the subsequent sends of TCP/IP packets may be held until an ACK is received. If Y is specified, the TCP/IP packets are sent immediately without waiting for an ACK of the previous send.

TraceIpcKey = *numeric*

For UNIX systems, specifies the IPC key value for the OSI TP log and trace shared memory segment. If there are multiple local domains, then each domain must have a unique IPC key value. On Windows NT systems, this value is ignored. The default is 32800.

Enabling Automatic Suspension of Remote Services

The BEA eLink OSI TP service suspend feature provides greater reliability for remote services by automatically suspending services for a remote domain that is unreachable. Automatic suspension prevents repeated calls to remote services that are no longer available. This feature is especially critical when load balancing between remote domains.

eLink OSI TP provides this service suspend feature by maintaining at least one association to every remote RDOM to determine its availability. If an association cannot be established, the services associated with that RDOM will immediately fail. Redundantly defined services will not attempt to use the unavailable RDOM and are diverted.

By default, eLink OSI TP will retry connections to an RDOM that has failed every 60 seconds. This delay may be overridden with the `RdomAssocRetry` tailor parameter described in the [“Tuning OSI TP-Specific Tables with the TAILOR File”](#) section. It may also be overridden for specific RDOMs using the `EXTENSIONS="RdomAssocRetry=n"` parameter in the `DM_OSITPX` section, where *n* is the number of seconds to wait between retries. The value specified on the `EXTENSIONS` parameter overrides the corresponding tailor parameter. Refer to [“DM_OSITPX Section”](#) for more information.

In test environments, RDOMs may be configured that are unavailable and are considered offline. ELink OSI TP continually tries to connect to these systems. To disable the RDOMs and the remote services configured to them, specify `EXTENSIONS="ONLINE=N"` on each offline RDOM in the `DM_OSITPX` section of the `DMCONFIG` file. At run-time, these RDOMs can be brought online using the `ONLINE osiadmin` command described in [“Using osiadmin Commands”](#).

5 Using the OSI TP Administration Utility

This section covers the following topics:

- [“About the osiadmin Processor”](#)
- [“Initiating osiadmin”](#)
- [“Using osiadmin Commands”](#)

About the osiadmin Processor

Administration of the OSITP functions for BEA eLink OSI TP is provided by the `osiadmin` processor. Administration commands are input from a command line or script file. `osiadmin` can be run regardless of whether or not the eLink OSI TP process is booted, allowing the user to perform configuration utilities, such as export and import, independently.

The `osiadmin` processor provides the following features:

- Sets internal traces while the OSITP process is up and running.
- Provides a snapshot dump of `NW_BEA` and `NW_UNISYS` internal tables.
- Performs test of OSITP connection to a remote domain.

- Imports configurations from OSI TP 1.3 (DMCONFIG, OSITP configuration, and ULS configuration) and creates a comparable configuration in proper format for BEA eLink OSI TP 4.x.
- Exports the `dmconfig` file and creates the correct format of the `config-in.txt` file needed for the UNISYS ClearPath systems.
- Administers multiple local domains on the same system through one `osiadmin` processor.
- Sends optional trace messages to the Tuxedo ULOG.

Initiating `osiadmin`

The `osiadmin` processor can be initiated in interactive, script, or batch mode. The `OSIRUNDIR` environment variable must be set in order to run the `osiadmin` utility. Refer to Setting Environment Variables for more information.

Initiating `osiadmin` in Interactive Mode

Enter the following interactive command at the command line:

```
osiadmin [LDM]
```

The local domain name (LDM) may be specified at `osiadmin` execution time. The LDM is the LDM identifier specified in the `Local_Domains` section of the `DMCONFIG` file.

Note: The LDM identifier is case sensitive.

For example,

```
osiadmin BA.CENTRAL01
```

where `BA.CENTRAL01` is the LDM.

The LDOM is necessary for CONNECTIONSTATUS, DUMP, TRACE, TESTCONNECTION, and LISTRDOM commands. If the LDOM is not specified on the command line, the user must enter an LDOM command before using any of these commands.

Initiating osiadmin in Script Mode

Enter the following command at the command line:

```
osiadmin [LDM]<input_script_name>osiadmin_output
```

where `input_script_name` is the name of a script file that you created with a series of one or more commands you wish to execute. If the script file is in a different directory, you must also enter the directory path. The script file is a text file that you can create with any text editor. Following is an example run of a script that might be used with `osiadmin`:

Listing 5-1 Example of an Osiadmin Input Script

```
>page off          Do not prompt for long output
>echo on          Echo input commands
>LDM BA.CENTRAL01 Set local domain name for
                  following commands
>lr              List remote domains in
                  BA.CENTRAL01 configuration
BA.BRANCH01
BA.BRANCH02
>tc BA.BRANCH01   Verify connection between
                  BA.CENTRAL01 and BA.BRANCH01
<Successfully connected to BA.BRANCH01
>tc BA.BRANCH02   Verify connection between
                  BA.CENTRAL01 and BA.BRANCH02

Successfully connected to BA.BRANCH02
>exit
```

Initiating osiadmin in Batch Mode

Enter the following command at the command line:

```
osiadmin -b
```

The "-b" option initiates the `osiadmin` in batch mode with the following conditions: the menu of commands that is normally displayed upon startup of `osiadmin` is not printed, pagination is set to off, command echo is set to on, and interactive prompts (for example, "Overwrite file, Y or N") are suppressed.

What Happens When You Execute an osiadmin Command?

When you initiate `osiadmin` or enter any of the other commands in interactive mode, the command executes if the syntax is correct. If the syntax is incorrect, an error message displays showing the correct syntax. When the command executes, results are printed to the screen. If the result is more than one page and `PAGINATE=ON` (which is the default), the prompt, "CONTINUE? Y or N" displays. Select Y to continue displaying another 20 lines or N to discontinue displaying the results.

At any time after a command has been executed, you can press `Enter` to redisplay the command syntax as shown by the `Help` command.

When you initiate `osiadmin` and enter commands using a script, the commands execute in order and the results are printed to the screen as the commands execute.

Using osiadmin Commands

All `osiadmin` commands are initiated through interactive mode or through a script containing one or more commands. The following sections explain how to get Help for `osiadmin` commands and provide descriptions for each command in detail.

Getting Help for osiadmin Commands

You can request a list of the valid `osiadmin` commands, request help for specific commands, or display command syntax after a command has been executed.

To display Help in interactive mode:

You can display a list of valid commands by entering the following command at the command line:

```
HELP
```

To display Help for a specific command:

Enter the following command at the command line:

```
HELP command
```

where `command` is any of the valid commands.

The exact syntax for the specified command displays.

osiadmin Commands

Following are descriptions of the valid `osiadmin` commands.

CONNECTIONSTATUS

Allows a user to display the connection status for one or more `RDOMS` or a pattern containing wildcard characters (*). For example, `CONNECTIONSTATUS *` lists the connection status for all `RDOMS`. `CONNECTIONSTATUS x*` lists the connection status for all `RDOMS` starting with the letter `x`.

When a wildcard character is used to specify the pattern for the `CONNECTIONSTATUS` command, only those `RDOMS` using the same protocol as the current `LDOM` are considered. For example, if the current `LDOM` is using the multiplex protocol, only the `RDOMS` configured with `MULTIPLEX=Y` are checked for connection status.

5 Using the OSI TP Administration Utility

Syntax: CONNECTIONSTATUS RDOM|pattern
OR
CS RDOM|pattern

DUMP

Produces a dump of internal eLink OSI TP tables including the NW_BEA and the NW_UNISYS portion of code for diagnostic purposes. If a filename is entered, that file is used for the dump. If the filename is not entered, the default dump file, OSITPDUMP.TXT, is used.

Syntax: DUMP [filename]
OR
DU [filename]

ECHO

Displays input command lines as they are entered when set to ON. If no option is given, the current setting is toggled and the new setting is printed. The initial setting is OFF.

Syntax: ECHO [OFF|ON]
OR
E [OFF|ON]

EXPORTCFG

Exports eLink OSI TP configuration information from the DMCONFIG file and creates configuration files readable by OSI-TP on UNISYS ClearPath servers. The names of the files produced are <output directory>TAILOR-IN.TXT and <output directory>CONFIG-IN.TXT. The output directory is optional. The current directory is the default if none is specified.

Syntax: EXPORTCFG RDOM DMCONFIG-SOURCE [<output directory>]
OR
EXCFG RDOM DMCONFIG-SOURCE [<output directory>]

IMPORTCFG

Imports the correct configuration information for the eLink gateway by automatically upgrading configurations from previous versions of the eLink gateway. `importcfg` specifies the `DMCONFIG` file, `OSITP` configuration file, and the `ULS` configuration file to be used for input. The `DMCONFIG` file is used as input to the `dmloadcf` processor. A `DMCONFIG` file is created as the output. The `ULS-TAILOR` and `NEW-TAILOR` files are optional and are only valid on Unix. If the output file already exists, a message is sent to confirm before overwriting the file. If no parameters are specified, the user is prompted for the filenames.

Syntax: `IMPORTCFG [<outfile> DMCONFIG-SOURCE OSITP-CONFIGFILE
{ULS-TAILOR-SOURCE NEW-TAILOR-SOURCE}]`

OR

`IMCFG [<outfile> DMCONFIG-SOURCE OSITP-CONFIGFILE
{ULS-TAILOR-SOURCE NEW-TAILOR-SOURCE}]`

Note: `OSITP-CONFIGFILE` is the source configuration file and not the `current.cfg` file that was required for older versions of BEA eLink OSI TP.

LDOM

Sets the local domain name. The `LDOM` must be set for the `DUMP`, `CONNECTIONSTATUS`, `TRACE`, `TESTCONNECTION`, and `LISTRDOM` commands. The `LDOM` can also be specified as an argument when executing the `osiadmin`.

Syntax: `LDOM [LDOM name]`

LISTRDOM

Retrieves and displays a list of all `RDOMs`. The list indicates if the `RDOMs` are offline or online, indicates if the online `RDOMs` are currently available, and indicates that communications with unavailable `RDOMs` are not operational. eLink OSI TP will try to establish communications until successful.

When the `LISTRDOM` command is run, only those `RDOMs` using the same protocol as the current `LDOM` are displayed. For example, if the current `LDOM` is using the multiplex protocol, only the `RDOMs` configured with `MULTIPLEX=Y` are listed.

Syntax: `LISTRDOM`
`OR`
`LR`

ONLINERDOM

Resets `RDOM` configured to be offline at startup to online. Once an `RDOM` is set `OFFLINE`, it must be manually reset to `ONLINE` before communications with the peer can continue. All remote services associated with the `RDOM` will be advertised.

The `ONLINERDOM` command changes the state of an `RDOM` to online. The state also immediately changes to available.

Multiplex Protocol If the current `LDOM` and the specified `RDOM` are using multiplexed protocol, and the multiplex policy is `STARTUP`, then eLink immediately attempts to establish a connection from the `LDOM` to the `RDOM`. If this fails, the state changes to online and unavailable; then connection attempts are retried until successful.

If the current `LDOM` and the specified `RDOM` are using multiplexed protocol, and the multiplex policy is `DEMAND`, then eLink does not attempt to establish a connection from the `LDOM` to the `RDOM` until it is needed to perform a `CALL` or `CONNECTION`. If this later connection fails, the state changes to online and unavailable; then connection attempts are retried until successful.

Non-Multiplex Protocol If the current `LDOM` and the specified `RDOM` are using non-multiplexed protocol, then eLink immediately attempts to establish a connection from the `LDOM` to the `RDOM`. If this later connection fails, the state changes to online and unavailable; then connection attempts are retried until successful.

Syntax: `ONLINERDOM RDOM`
`OR`
`ONL RDOM`

PAGINATE

Turns paginate mode `ON` or `OFF`. Default is `ON`.

Syntax: PAGINATE {OFF|ON}

OR

PAGE {OFF|ON}

TESTCONNECTION

Use the TESTCONNECTION command to verify that a connection to the RDOM can be established. This is useful to verify that the configuration is correct and the network is working properly.

Multiplex Protocol If the current LDOM is using multiplexed protocol, this command checks to see if a connection already exists. If so, the command returns immediately indicating success. If no connection exists, this command attempts to establish a new connection and waits for the result before returning. The new connection is left open for future use.

Non-Multiplex Protocol If the current LDOM is using non-multiplexed protocol, this command attempts to establish a new connection and waits for the result before returning. Then the new connection is closed.

Syntax: TESTCONNECTION RDOM

OR

TC RDOM

TRACE

Sets trace levels in eLink OSI TP for diagnostics and debugging purposes. When TRACE is set to ON, messages are written to the Tuxedo ULOG. If the TRACE command is entered without any options, it returns the current trace level.

Syntax: TRACE {OFF|ON}

OR

TR {OFF|ON}

A Utilities Reference

This section covers the following utilities that are commonly used for eLink OSI TP:

- [DMADM](#)
- [dmadmin](#)
- [GWADM Tuxedo Administrator's Guide](#)

DMADM

/Domain administrative server.

SYNOPSIS `DMADM SRVGRP = "identifier"`
`SRVID = "number"`
`REPLYQ = "N"`

DESCRIPTION The /DOMAIN administrative server `DMADM` is a Tuxedo-supplied server that provides run-time access to the `BDMCONFIG` file. When `DMADM` is booted, the `BDMCONFIG` environment variable should be set to the pathname of the file containing the binary version of the `DMCONFIG` file.

`DMADM` is described in the `*SERVERS` section of the `UBBCONFIG` file as a server running within a group, e.g., `DMADMGRP`. There should be only one instance of the `DMADM` running in this group and it must not have a reply queue (`REPLYQ` must be set to "N").

The following server parameters can also be specified for the `DMADM` server in the `*SERVERS` section: `SEQUENCE`, `ENVFILE`, `MAXGEN`, `GRACE`, `RESTART`, `RQPERM` and `SYSTEM_ACCESS`.

- PORTABILITY** DMADM is supported as a Tuxedo-supplied server on non-/WS System operating systems.
- INTEROPERABILITY** The initial release of eLink OSI TP can only be installed on a node running Tuxedo Release 6.5 or Release 7.1.
- EXAMPLES** The following example illustrates the definition of the administrative server and a gateway group in the `UBBCONFIG` file.

```
#
*GROUPS
DMADMGRP  LMID=mach1 GRPNO=1
gwgrp     LMID=mach1 GRPNO=2
#
*SERVERS
DMADM SRVGRP="DMADMGRP" SRVID=1001 REPLYQ=N RESTART=Y GRACE=0
GWADM SRVGRP="gwgrp" SRVID=1002 REPLYQ=N RESTART=Y GRACE=0
GWOSITP SRVGRP="gwgrp" SRVID=1003 RQADDR="gwgrp"
RESTART=Y MIN=1 MAX=1
```

SEE ALSO *Tuxedo /Domain Guide, Tuxedo Administrator's Guide*

dmadmin

OSITP Domain Administration Command Interpreter.

SYNOPSIS `dmadmin [-c]`

DESCRIPTION `dmadmin` is an interactive command interpreter used for the administration of domain gateway groups defined for a particular OSITP application. `dmadmin` can operate in two modes: administration mode and configuration mode.

`dmadmin` enters *administration* mode when called with no parameters. This is the default. In this mode, `dmadmin` can be run on any active node (excluding workstations) within an active application. Application administrators can use this mode to obtain or change parameters on any active domain gateway group.

Note: `dmadmin` is one of the three methods you can use to modify your configuration. Refer to [“Methods for Modifying Configurations”](#) for more information.

Application administrators may also use this mode to create, destroy, or reinitialize the DMTLOG for a particular local domain. In this case, the domain gateway group associated with that local domain must not be active, and dmadmin must be run on the machine assigned to the corresponding gateway group.

dmadmin enters *configuration* mode when it is invoked with the `-c` option or when the *config* subcommand is invoked. Application administrators can use this mode to update or add new configuration information to the binary version of the domain configuration file BDMCONFIG.

dmadmin requires the use of the DOMAIN administrative server DMADM for the administration of the BDMCONFIG file and the gateway administrative server GWADM for the re-configuration of active DOMAIN gateway groups (there is one GWADM per gateway group).

ADMINISTRATION Once dmadmin has been invoked, commands may be entered at the prompt (“>”) MODE according to the following syntax: COMMANDS

command [arguments]

Several commonly occurring arguments can be given default values via the default command. Commands that accept parameters set via the default command check default to see if a value has been set. If no value is set, an error message is returned.

Once set, a default value remains in effect until the session is ended, unless changed by another default command. Defaults may be overridden by entering an explicit value on the command line, or unset by entering the value “*”. The effect of an override lasts for a single instance of the command.

Output from dmadmin commands is paginated according to the pagination command in use (see the definition for the paginate subcommand).

Commands may be entered either by their full name or their abbreviation (shown in parentheses) followed by any appropriate arguments. Arguments appearing in square brackets, [], are optional; those in curly braces, {}, indicate a selection from mutually exclusive options. Note that for many commands *local_domain_name* is a required argument, but note also that it can be set with the default command.

The following commands are available in administration mode

addumap [options]

Add local user mappings to remote user mappings for a local/remote domain pair. Mappings are defined to be inbound, outbound or both. See the addumap manual page for an explanation of the available options and for examples.

- `addusr (addu) [options]`
Add remote usernames and passwords to the remote user and password tables of a remote domain. See the `addusr` manual page for an explanation of the available options and for examples.
- `advertise (adv) -d local_domain_name [{ -all | service }]`
Advertise all remote services provided by the named local domain or the specified remote service.
- `audit (audit) -d local_domain_name [{off | on}]`
Activate (on) or deactivate (off) the audit trace for the named local domain. If no option is given, then the current setting will be toggled between the values `on` and `off`, and the new setting will be printed. The initial setting is `off`.
- `chbktme (chbt) -d local_domain_name -t bktime`
Change the blocking timeout for a particular local domain.
- `config (config)`
Enter configuration mode. Commands issued in this mode follow the conventions defined in the section “CONFIGURATION MODE COMMANDS” on page A-7.
- `crdmlog (crdlg) -d local_domain_name`
Create the domain transaction log for the named local domain on the current machine (that is, the machine where `dmadmin` is running). The command uses the parameters specified in the `DMCONFIG` file. This command fails if the named local domain is active on the current machine or if the log already exists.
- `default (d) [-d local_domain_name]`
Set the corresponding argument to be the default local domain. Defaults may be unset by specifying “*” as an argument.

If the `default` command is entered with no arguments, the current default values are printed.
- `delumap [options]`
Delete local to remote user mappings for a local/remote domain pair. See the `delumap` manual page for an explanation of the available options and for examples.

`delusr (delu) [options]`

Delete remote usernames and passwords from the remote user and password tables of a remote domain. See the `delusr` reference page for an explanation of the available options and for examples.

`dsdmlog (dsdlg) -d local_domain_name [-y]`

Destroy the domain transaction log for the named local domain on the current machine (that is, the machine where `dmadmin` is running). An error is returned if a `DMTLOG` is not defined for this local domain, if the local domain is active, or if outstanding transaction records exist in the log. The term outstanding transactions means that a global transaction has been committed but an end-of-transaction has not yet been written. This command prompts for confirmation before proceeding unless the `-y` option is specified.

`echo (e) [{off | on}]`

Echo input command lines when set to `on`. If no option is given, then the current setting is toggled, and the new setting is printed. The initial setting is `off`.

`forgettrans (ft) -d local_domain_name [-t tran_id]`

Forget one or all heuristic log records for the named local domain. If the transaction identifier `tran_id` is specified, then only the heuristic log record for that transaction will be forgotten. The transaction identifier `tran_id` can be obtained from the `printtrans` command or from the `ULOG` file.

`help (h) [command]`

Print help messages. If `command` is specified, the abbreviation, arguments, and description for that command are printed. Omitting all arguments causes the syntax of all commands to be displayed.

`indmlog (indlg) -d local_domain_name [-y]`

Reinitialize the domain transaction log for the named local domain on the current machine (that is, the machine where `dmadmin` is running). An error is returned if a `DMTLOG` is not defined for this local domain, if the local domain is active, or if outstanding transaction records exist in the log. The term outstanding transactions means that a global transaction has been committed but an end-of-transaction has not yet been written. The command prompts for confirmation before proceeding unless the `-y` option is specified.

`modusr (modu) [options]`

Change remote passwords in the password tables of a remote domain.

`paginate (page) [{off | on}]`

Paginate output. If no option is given, then the current setting will be toggled, and the new setting is printed. The initial setting is on, unless either standard input or standard output is a non-tty device. Pagination may only be turned on when both standard input and standard output are tty devices. The shell environment variable `PAGER` may be used to override the default command used for paging output. The default paging command is indigenous to the native operating system environment.

`passwd (passwd) [-r] local_domain_name remote_domain_name`

Prompts the administrator for new passwords for the specified local and remote domains. The `-r` option specifies that existing passwords and new passwords should be encrypted using a new key generated by the system. The password is truncated after at most eight characters. The eLink OSI TP gateway must be shut down and restarted for new passwords to take effect.

`printdomain (pd) -d local_domain_name`

Print information about the named local domain. Information printed includes connected remote domains, global information shared by the gateway processes, and additional information that is dependent on the domain type instantiation.

`printstats (stats) -d local_domain_name`

Print statistical and performance information gathered by the named local domain. The information printed is dependent on the domain gateway type.

`printtrans (pt) -d local_domain_name`

Print transaction information for the named local domain.

`quit (q)`

Terminate the session.

`resume (res) -d local_domain_name [{ -all | service}]`

Resume processing of the specified service or for all remote services handled by the named local domain.

`stats (stats) -d local_domain_name [{ off | on | reset }]`

Activate (*on*), deactivate (*off*), or reset (*reset*) statistics gathering for the named local domain. If no option is given, then the current setting will be toggled between the values *on* and *off*, and the new setting will be printed. The initial setting is *off*.

```
suspend (susp) -d local_domain_name [{ -all | service}]
    Suspend one or all remote services for the named local domain.

unadvertise (unadv) -d local_domain_name [{ -all | service}]
    Unadvertise one or all remote services for the named local domain.

verbose (v) [{off | on}]
    Produce output in verbose mode. If no option is given, then the current setting
    will be toggled, and the new setting is printed. The initial setting is off.

! shellcommand
    Escape to shell and execute shellcommand.

!!
    Repeat previous shell command.

# [text]
    Lines beginning with "#" are comment lines and are ignored.

<CR>
    Repeat the last command.
```

CONFIGURATION MODE COMMANDS The dmadmin command enters configuration mode when executed with the `-c` option or when the `config` subcommand is used. In this mode, dmadmin allows run-time updates to the `BDMCONFIG` file. dmadmin manages a buffer that contains input field values to be added or retrieved, and displays output field values and status after each operation completes. The user can update the input buffer using any available text editor.

dmadmin first prompts for the desired section followed by a prompt for the desired operation.

The prompt for the section is as follows:

```
Sections:
    1) RESOURCES                2) LOCAL_DOMAINS
    3) REMOTE_DOMAINS          4) LOCAL_SERVICES
    5) REMOTE_SERVICES         6) ROUTING
    7) ACCESS_CONTROL          8) PASSWORDS
    9) TDOMAINS                10) OSITPS
   11) SNADOMS                 12) LOCAL_REMOTE_USER
   13) REMOTE_USERS            14) SNACRMS
   15) SNASTACKS               16) SNALINKS
   18) TOPEND                  19) OSITPX
   q) QUIT
Enter Section [1]
```

The number of the default section appears in square brackets at the end of the prompt. You can accept the default by pressing **RETURN** or **ENTER**. To select another section enter its number, then press **RETURN** or **ENTER**.

dmadmin then prompts for the desired operation.

```
Operations:
    1) FIRST           2) NEXT
    3) RETRIEVE       4) ADD
    5) UPDATE         6) DELETE
    7) NEW_SECTION    8) QUIT
Enter Operation [1]:
```

The number of the default operation is printed in square brackets at the end of the prompt. Pressing **RETURN** or **ENTER** selects this option. To select another operation enter its number, then press **RETURN** or **ENTER**.

The currently supported operations are

1 FIRST

Retrieve the first record from the specified section. No key fields are needed (they are ignored if in the input buffer).

2 NEXT

Retrieve the next record from the specified section, based on the key fields in the input buffer.

3 RETRIEVE

Retrieve the indicated record from the specified section by key field(s) (see the following fields description).

4 ADD

Add the indicated record in the specified section. Any fields not specified (unless required) take their default values as specified in `dmconfig`. The current value for all fields is returned in the output buffer. This operation can only be done by the System/T administrator.

5 UPDATE

Update the record specified in the input buffer in the selected section. Any fields not specified in the input buffer remain unchanged. The current value for all fields is returned in the input buffer. This operation can only be done by the System/T administrator.

6 DELETE

Delete the record specified in the input buffer from the selected section. This operation can only be done by the System/T administrator.

7 NEW SECTION

Clear the input buffer (all fields are deleted). After this operation, `dmadmin` immediately prompts for the section again.

8 QUIT

Exit the program gracefully (`dmadmin` is terminated). A value of `q` for any prompt also exits the program.

For configuration operations, the effective user identifier must match the System/T administrator user identifier `UID` for the machine on which this program is executed. When a record is updated or added, all default values and validations used by `udmloadcf` are enforced.

`dmadmin` then prompts whether or not to edit the input buffer.

```
Enter editor to add/modify fields [n]?
```

Entering a value of `y` will put the input buffer into a temporary file and execute the text editor. The environment variable `EDITOR` is used to determine which editor to be used; the default is “`ed`”. The input format is in field name/field value pairs and is described in the CONFIGURATION INPUT FORMAT section that follows. The field names associated with each `DMCONFIG` section are listed in tables in the subsections that follow. The semantics of the fields and associated ranges, default values, restrictions, etc., are described in `dmconfig`. In most cases, the field name is the same as the `KEYWORD` in the `DMCONFIG` file, prefixed with “`TA_DM`”. When the user completes editing the input buffer, `dmadmin` reads it. If more than one line occurs for a particular field name, the first occurrence is used and other occurrences are ignored. If any errors occur, a syntax error will be printed and `dmadmin` prompts whether or not to correct the problem.

```
Enter editor to correct?
```

If the problem is not corrected (response `n`), then the input buffer will contain no fields. Otherwise, the editor is executed again.

Finally, `dmadmin` asks if the operation should be done.

```
Perform operation [y]?
```

When the operation completes, `dmadmin` prints the return value as in

Return value TAOK

followed by the output buffer fields. The process then begins again with a prompt for the section. All output buffer fields are available in the input buffer unless the buffer is cleared.

Entering break at any time restarts the interaction at the prompt for the section.

When “QUIT” is selected, `dmadmin` prompts for authorization to create a backup ASCII version of the configuration:

```
Unload BDMCONFIG file into ASCII backup [y]?
```

If a backup is selected, `dmadmin` prompts for the file name.

```
Backup filename [DMCONFIG]?
```

On success, `dmadmin` indicates that a backup was created, otherwise an error is printed.

CONFIGURATION INPUT FORMAT

Input packets consist of lines formatted as follows:

```
fldname<tabs>fldval
```

The field name is separated from the field value by one or more tabs (or spaces).

Lengthy field values can be continued on the next line by having the continuation line begin with one or more tabs (which are dropped when read back into `dmadmin`).

Empty lines consisting of a single newline character are ignored.

To enter an unprintable character in the field value or to start a field value with a tab, use a backslash followed by the two-character hexadecimal representation of the desired character. A space, for example, can be entered in the input data as `\20`. A backslash can be entered using two backslash characters. `dmadmin` recognizes all input in this format, but its greatest usefulness is for non-printing characters.

CONFIGURATION LIMITATIONS

The following are general limitations of the dynamic domain re-configuration capability:

- Values for key fields (as indicated in the following sections) may not be modified. Key fields can be modified, when the system is down, by reloading the configuration file.
- Dynamic deletions cannot be applied when local domains are active (the corresponding gateway group is running).

RESTRICTIONS FOR CONFIGURATION FIELD IDENTIFIERS/UPDATES

The following sections describe, for each `DMCONFIG` section, what the field identifiers are for each `DMCONFIG` field, what the field type of the identifier is, and when the field can be updated. All applicable field values are returned with the retrieval operations. Fields that are allowed and/or required for adding a record are described in `dmconfig`. The following fields indicated as *key* are key fields that are used to uniquely identify a record within section. These key fields are required to be in the input buffer when updates are done and are not allowed to be updated dynamically. The `Update` column indicates when a field can be updated. The possible values are

Yes

Can be updated at any time.

NoGW

Cannot be updated dynamically while the gateway group representing the local domain is running.

No

Cannot be updated dynamically while at least one gateway group is running.

CONFIGURING THE `DM_LOCAL_DOMAINS` SECTION

The following table lists the fields in the `DM_LOCAL_DOMAINS` section.

Table A-1 DM_LOCAL_DOMAINS SECTION

Field Identifier	Field Type	Update	Notes
<code>TA_AUDITLOG</code>	string	Yes	
<code>TA_BLOCKTIME</code>	numeric	Yes	
<code>TA_DMTLOGDEV</code>	string	NoGW	
<code>TA_DMTLOGNAME</code>	string	NoGW	
<code>TA_DMTLOGSIZE</code>	numeric	NoGW	
<code>TA_DOMAINID</code>	string	NoGW	
<code>TA_GWGRP</code>	string	NoGW	
<code>TA_LDOM</code>	string	NoGW	key
<code>TA_MAXDATALEN</code>	numeric	Yes	
<code>TA_MAXRDOM</code>	numeric	Yes	
<code>TA_MAXRDTRAN</code>	numeric	NoGW	

Table A-1 DM_LOCAL_DOMAINS SECTION

Field Identifier	Field Type	Update	Notes
TA_MAXTRAN	numeric	NoGW	
TA_SECURITY	string	Yes	format: {NONE APP_PW DM_PW}
TA_TYPE	string	NoGW	format: {TDOMAIN OSITP OSITPX SNA}

Refer to the “[DM_LOCAL_DOMAINS Section](#)” in “Understanding the DMCONFIG File” for information about some of these fields information.

CONFIGURING
THE
DM_REMOTE_
DOMAINS
SECTION

The following table lists the fields in the DM_REMOTE_DOMAINS section.

Table A-2 DM_REMOTE_DOMAINS SECTION

Field Identifier	Field Type	Update	Notes
TA_DOMAINID	string	No	
TA_RDOM	string	No	key
TA_TYPE	string	No	format: {TDOMAIN OSITP OSITPX SNA}

Refer to the “[DM_REMOTE_DOMAINS Section](#)” in “Understanding the DMCONFIG File” for related information about some of these fields.

CONFIGURING
THE DM_OSITPX
SECTION

The DM_OSITPX section contains the network addressing parameters required by OSITPX type domains. The following lists the fields in this section:

Table A-3 DM_OSITPX SECTION

Field Identifier	Field Type	Update	Notes
TA_AET	string	No/NoGW	
TA_DNSRESOLUTION	string	No/NoGW	
TA_EXTENSIONS	string	No/NoGW	
TA_LDOM or TA_RDOM	string	No/NoGW	key

Table A-3 DM_OSITPX SECTION

Field Identifier	Field Type	Update	Notes
TA_MAXENCRYPTBITS	string	No/NoGW	
TA_MINENCRYPTBITS	string	No/NoGW	
TA_MULTIPLEXING	string	No/NoGW	
TA_NWADDR	string	No/NoGW	
TA_OPTIONS	string	No/NoGW	
TA_OSITPX	string	No/NoGW	
TA_PSEL	string	No/NoGW	
TA_SSEL	string	No/NoGW	
TA_TAILORPATH	string	No/NoGW	
TA_TSEL	string	No/NoGW	
TA_XATMIENCODING	string	No/NoGW	

If the domain identifier (TA_LDOM) is a local domain identifier, then the other fields in this table can be updated if the gateway group representing that local domain is not running.

Refer to the [“DM_OSITPX Section”](#) in “Understanding the DMCONFIG File” for related information about some of these fields.

CONFIGURING
THE DM_LOCAL_
SERVICES
SECTION

The following table lists the fields in the DM_LOCAL_SERVICES section.

Table A-4 DM_LOCAL_SERVICES SECTION

Field Identifier	Field Type	Update	Notes
TA_AUTOPREPARE	string	Yes	
TA_BLOCKTIME	string	No	
TA_BUFSTYPE	string	Yes	INBUF SUBTYPE
TA_BUFTYPE	string	Yes	INBUF

Table A-4 DM_LOCAL_SERVICES SECTION

Field Identifier	Field Type	Update	Notes
TA_CONV	string	NoGW	format: {Y N}
TA_COUPLING	string	Yes	
TA_INRECSTYPE	string	Yes	INRECTYPE SUBTYPE
TA_INRECTYPE	string	Yes	
TA_LDOM	string	No	key
TA_LOAD	string	No	
TA_OBUFSTYPE	string	Yes	OUTBUF SUBTYPE
TA_OBUFTYPE	string	Yes	OUTBUF
TA_OUTRECSTYPE	string	Yes	OUTRECTYPE SUBTYPE
TA_PRIO	string	No	
TA_RDOM	string	No	key
TA_REMTPSUT	string	No/NoGW	
TA_RNAME	string	Yes	
TA_ROUTINGNAME	string	No	
TA_SERVICENAME	string	No	key
TA_TPSUTTYPE	string	No/NoGW	
TA_TRANTIME	string	Yes	

Refer to the [“DM_LOCAL_SERVICES Section”](#) in “Understanding the DMCONFIG File” for related information about some of these fields.

CONFIGURING
THE
DM_REMOTE_
SERVICES
SECTION

The following table lists the fields in the DM_REMOTE_SERVICES section.

Table A-5 DM_REMOTE_SERVICES SECTION

Field Identifier	Field Type	Update	Notes
TA_BUFSTYPE	string	Yes	INBUF SUBTYPE
TA_BUFTYPE	string	Yes	INBUF
TA_CONV	string	NoGW	format: { Y N }
TA_INRECSTYPE	string	Yes	INRECTYPE SUBTYPE
TA_LDOM	string	No	key
TA_OBUFSTYPE	string	Yes	OUTBUF SUBTYPE
TA_OBUFTYPE	string	Yes	OUTBUF
TA_OUTRECSTYPE	string	Yes	OUTRECTYPE SUBTYPE
TA_RDOM	string	No	key
TA_RNAME	string	Yes	
TA_ROUTINGNAME	string	Yes	
TA_SERVICENAME	string	No	key
TA_TRANTIME	numeric	Yes	

Refer to the [“DM_REMOTE_SERVICES Section”](#) in “Understanding the DMCONFIG File” for related information about some of these fields.

CONFIGURING
THE
DM_ROUTING
SECTION

The following table lists the fields in the DM_ROUTING section.

Table A-6 DM_ROUTING SECTION

Field Identifier	Field Type	Update	Notes
TA_ROUTINGNAME	string	No	key
TA_FIELD	string	Yes	
TA_RANGE	string	Yes	

Table A-6 DM_ROUTING SECTION

Field Identifier	Field Type	Update	Notes
TA_BUFTYPE	string	Yes	

Refer to the “[DM_ROUTING Section](#)” in “Understanding the DMCONFIG File” for related information.

CONFIGURING
THE
DM_ACCESS_
CONTROL
SECTION

The following table lists the fields in the DM_ACCESS_CONTROL section.

Table A-7 DM_ACCESS_CONTROL SECTION

Field Identifier	Field Type	Update	Notes
TA_ACLNAME	string	No	key
TA_RDOM	string	Yes	

Refer to the “[DM_ACCESS_CONTROL Section](#)” in “Understanding the DMCONFIG File” for related information.

CONFIGURING
THE
DM_PASSWORDS
SECTION

The following table lists the fields in the DM_PASSWORDS section.

Table A-8 DM_PASSWORDS SECTION

Field Identifier	Field Type	Update	Notes
TA_LDOM	string	No	key
TA_RDOM	string	No	key
TA_LPWD	string	Yes	format: { Y N U }
TA_RPWD	string	Yes	format: { Y N U }

The TA_LPWD and TA_RPWD show the existence of a defined password for the local and/or the remote domain. Passwords are not displayed. If an UPDATE operation is selected, the value of the corresponding field must be set to U. The program will then prompt with echo turned off for the corresponding passwords.

DIAGNOSTICS IN dmadmin fails if it cannot allocate an FML typed buffer, if it cannot determine the
CONFIGURATION /etc/passwd entry for the user, or if it cannot reset the environment variables
MODE FIELDTBLS or FLDTBLDIR.

The return value printed by dmadmin after each operation completes indicates the status of the requested operation. There are three classes of return values.

The following return values indicate a problem with permissions or an OSITP communications error. They indicate that the operation did not complete successfully.

[TAEPERM]

The calling process specified an ADD, UPDATE, or DELETE operation but it is not running as the System/T administrator. Update operations must be run by the administrator (that is, the user specified in the UID attribute of the RESOURCES section of the TUXCONFIG file).

[TAESYSTEM]

An OSITP error has occurred. The exact nature of the error is written to userlog.

[TAEOS]

An operating system error has occurred.

[TAETIME]

A blocking timeout occurred. The input buffer is not updated so no information is returned for retrieval operations. The status of update operations can be checked by doing a retrieval on the record that was being updated.

The following return values indicate a problem in doing the operation itself and generally are semantic problems with the application data in the input buffer. The string field TA_STATUS will be set in the output buffer and will contain short text describing the problem. The string field TA_BADFLDNAME will be set to the field name for the field containing the value that caused the problem (assuming the error can be attributed to a single field).

[TAECONFIG]

An error occurred while reading the BDMCONFIG file.

[TAEDUPLICATE]

The operation attempted to add a duplicate record.

[TAEINCONSIS]

A field value or set of field values are inconsistently specified.

[TAENOTFOUND]

The record specified for the operation was not found.

[TAENOSPACE]

The operation attempted to do an update but there was not enough space in the `BDMCONFIG` file.

[TAERANGE]

A field value is out of range or is invalid.

[TAEREQUIRED]

A field value is required but not present.

[TAESIZE]

A field value for a string field is too long.

[TAEUPDATE]

The operation attempted to do an update that is not allowed.

The following return values indicate that the operation was successful.

[TAOK]

The operation succeeded. No updates were done to the `BDMCONFIG` file.

[TAUPDATED]

The operation succeeded. Updates were made to the `BDMCONFIG` file.

When using `dmunloadcf` to print entries in the configuration, optional field values are not printed if they are not set (for strings) or 0 (for integers). These fields will always appear in the output buffer when using `dmadmin`. In this way, it makes it easier for the administrator to retrieve an entry and update a field that previously was not set. The entry will have the field name followed by a tab but no field value.

CONFIGURATION EXAMPLE In the following example, `dmadmin` is used to add a new remote domain. For illustration purposes, `ed` is used for the editor.

```
$EDITOR=vi dmadmin -c
dmadmin - Copyright (c) 1996-1999 BEA Systems, Inc.
Portions * Copyright 1986-1997 RSA Data Security, Inc.
All Rights Reserved.
Distributed under license by BEA Systems, Inc.
Tuxedo is a registered trademark.
Section:
    1) RESOURCES           2) LOCAL_DOMAINS
    3) REMOTE_DOMAINS     4) LOCAL_SERVICES
    5) REMOTE_SERVICES    6) ROUTING
```

```

        7) ACCESS_CONTROL  8) PASSWORDS
        9) TDOMAINS       10) OSITPS
       11) SNADOMS        12) LOCAL_REMOTE_USER
       13) REMOTE_USERS   14) SNACRMS
       15) SNASTACKS     16) SNALINKS
       18) TOPEND        19) OSITPX
       q) QUIT

```

Enter Section [1]:3

Operations:

```

        1) FIRST          2) NEXT
        3) RETRIEVE      4) ADD
        5) UPDATE        6) DELETE
        7) NEW_SECTION  8) QUIT

```

Enter Operation [1]:4

Enter editor to add/modify fields [n]? y

In VI...

a

```

TA_RDOM          B05
TA_DOMAINID     BA.BANK05
TA_TYPE         OSITPX

```

wq!

Perform operation [y]?

Return value TAUPDATED

Buffer contents:

```

TA_OPERATION     4
TA_CLASS        3
TA_OCCURS       1
TA_DMINPRIORITY 0
TA_STATUS       CMDGW_CAT:1761: INFO: Update completed successfully
TA_TYPE OSITPX
TA_DOMAINID     BA.BANK05
TA_RDOM B05
TA_CODEPAGE
TA_DMACLPOLICY LOCAL
TA_DMCONNPRINCIPALNAME
TA_DMLOCALPRINCIPALNAME
TA_DMPRIORITY_TYPE LOCAL_RELATIVE
TA_DMCRENDENTIALPOLICY LOCAL

```

Section:

```

        1) RESOURCES      2) LOCAL_DOMAINS
        3) REMOTE_DOMAINS 4) LOCAL_SERVICES
        5) REMOTE_SERVICES 6) ROUTING
        7) ACCESS_CONTROL 8) PASSWORDS
        9) TDOMAINS     10) OSITPS
       11) SNADOMS      12) LOCAL_REMOTE_USER
       13) REMOTE_USERS 14) SNACRMS

```

```

        15) SNASTACKS          16) SNALINKS
        18) TOPEND            19) OSITPX
        q) QUIT
Enter Section [3]:

Operations:
        1) FIRST              2) NEXT
        3) RETRIEVE          4) ADD
        5) UPDATE            6) DELETE
        7) NEW_SECTION      8) QUIT
Enter Operation [4]:7
Buffer cleared
Section:
        1) RESOURCES         2) LOCAL_DOMAINS
        3) REMOTE_DOMAINS   4) LOCAL_SERVICES
        5) REMOTE_SERVICES  6) ROUTING
        7) ACCESS_CONTROL   8) PASSWORDS
        9) TDOMAINS        10) OSITPS
       11) SNADOMS         12) LOCAL_REMOTE_USER
       13) REMOTE_USERS    14) SNACRMS
       15) SNASTACKS      16) SNALINKS
       18) TOPEND         19) OSITPX
        q) QUIT
Enter Section [3]:19

Operations:
        1) FIRST              2) NEXT
        3) RETRIEVE          4) ADD
        5) UPDATE            6) DELETE
        7) NEW_SECTION      8) QUIT
Enter Operation [7]:4
Enter editor to add/modify fields [n]? y
From VI editor...
a
TA_OSITPX          B05
TA_NWADDR          206.189.43.44
TA_AET             {1.3.9999.1},{1}
wq!

Perform operation [y]?

Return value TAUPDATED
Buffer contents:
TA_OPERATION      4
TA_CLASS          19
TA_OCCURS         1
TA_MULTIPLEXING  0
TA_MINENCRYPTBITS 0
TA_MAXENCRYPTBITS 0
```



```

TA_STATUS          CMDGW_CAT:1761: INFO: Update completed successfully
TA_NWADDR          206.189.43.44
TA_AET {1.3.9999.1}, {1}
TA_OSITPX          B05
TA_TSEL
TA_TAILORPATH
TA_PSEL
TA_SSEL
TA_EXTENSIONS
TA_DNSRESOLUTION   STARTUP
TA_OPTIONS
TA_XATMIENCODING   PRELIMINARY
  
```

Section:

- 1) RESOURCES
- 2) LOCAL_DOMAINS
- 3) REMOTE_DOMAINS
- 4) LOCAL_SERVICES
- 5) REMOTE_SERVICES
- 6) ROUTING
- 7) ACCESS_CONTROL
- 8) PASSWORDS
- 9) TDOMAINS
- 10) OSITPS
- 11) SNADOMS
- 12) LOCAL_REMOTE_USER
- 13) REMOTE_USERS
- 14) SNACRMS
- 15) SNASTACKS
- 16) SNALINKS
- 18) TOPEND
- 19) OSITPX
- q) QUIT

Enter Section [19]:q

Unload BDMCONFIG file into ASCII backup [y]? y

Backup filename [DMCONFIG]?

Configuration backed up in DMCONFIG

q

The dmadmin program ends.

SECURITY If dmadmin is run with the application administrator's UID, it assumes a trusted user and Security is bypassed. If dmadmin is run with another user ID, and if the security option is enabled in the TUXCONFIG file, then the corresponding application password is required to start the dmadmin program. If standard input is a terminal, then dmadmin will prompt the user for the password with echo turned off. If standard input is not a terminal, the password is retrieved from the environment variable, APP_PW. If this environment variable is not specified and an application password is required, then dmadmin will fail to start.

When running with another user ID (other than the UID of the administrator) only a limited set of commands is available.

ENVIRONMENT VARIABLES dmadmin resets the FIELDTBLS and FLDTBLDIR environment variables to pick up the \${TUXDIR}/udataobj/dmadmin field table. Hence, the TUXDIR environment variable should be set correctly.

If the application requires security and the standard input to `dmadmin` is not from a terminal, then the `APP_PW` environment variable must be set to the corresponding application password.

The `TUXCONFIG` environment variable should be set to the pathname of the OSITP configuration file.

GENERAL DIAGNOSTICS If the `dmadmin` command is entered before the system has been booted, the following message is displayed:

```
No bulletin board exists. Only logging commands are available.
```

```
dmadmin then prompts for the corresponding commands.
```

If an incorrect application password is entered or is not available to a shell script through the environment, then a log message is generated, the following message is displayed, and the command terminates:

```
Invalid password entered.
```

SEE ALSO *Tuxedo /Domain Guide*

GWADM

/Domain gateway administrative server.

SYNOPSIS `GWADM SRVGRP = "identifier" SRVID = "number" REPLYQ = "N"
CLOPT = "-A -- [-a {on | off}] [-s services]
[-t {on | off}]"`

DESCRIPTION The gateway administrative server `GWADM` is a Tuxedo-supplied server that provides administrative functions for a */Domain gateway group*.

`GWADM` should be defined in the `*SERVERS` section of the `UBBCONFIG` file as a server running within a particular gateway group, that is, `SRVGRP` must be set to the corresponding `GRPNAME` tag specified in the `*GROUPS` section. The `SRVID` parameter is also required and its value must consider the maximum number of gateways allowed within the gateway group.

There should be only one instance of a GWADM per /Domain gateway group, and it should NOT be part of the MSSQ defined for the gateways associated with the group. Also, GWADM should have the REPLYQ attribute set to N.

The CLOPT option is a string of command line options that is passed to the GWADM when it is booted. This string has the following format:

```
CLOPT="-A -- <gateway group runtime parameters>"
```

The following runtime parameters are recognized for a gateway group

```
-a {on | off}
```

This option turns *off* or *on* the audit log feature for this local domain. The default is *off*. The `dmadmin` program can be used to change this setting while the gateway group is running (see `dmadmin`).

```
-s services
```

Specifies the remote *services* that should be initially offered by the domain gateway. The specifications for these services are found in the `DMCONFIG` file. For example, the specification

```
-s x,y,z
```

implies that the gateway should initially advertise remote services *x*, *y*, and *z*. Spaces are not allowed between commas and the `-s` option may appear several times.

```
-t {on | off}
```

This option turns *off* or *on* the statistics gathering feature for the local domain. The default is *off*. The `dmadmin` program can be used to change this setting while the gateway group is running (see `dmadmin`).

The GWADM server must be booted before the corresponding gateways.

PORTABILITY GWADM is supported on Tuxedo-supplied servers, using non-/WS operating systems.

INTEROPERABILITY The initial release of eLink OSI TP can only be installed on a node running Tuxedo Release 6.5 or Release 7.1.

EXAMPLES The following example illustrates the definition of the administrative server in the `UBBCONFIG` file.

```
#
*GROUPS
DMADMGRP  GRPNO=1
gwgrp     GRPNO=2
```

```
#
*SERVERS
DMADM SRVGRP="DMADMGRP" SRVID=1001 RESTART=Y GRACE=0
GWADM SRVGRP="gwgrp" SRVID=1002 RESTART=Y GRACE=0
      CLOPT="-A -- -a on -t on"
GWTDOMAIN SRVGRP="gwgrp" SRVID=1003
RESTART=Y MIN=1 MAX=1
```

SEE ALSO `dmadmin`, `tmboot`

`dmconfig`, `DMADM`, `servopts`, `ubbconfig`

Tuxedo /Domain Guide

Tuxedo Administrator's Guide

B Manually Upgrading BEA eLink OSI TP to Version 4.2

If you are upgrading from an older version of eLink OSI TP to version 4.2, you must modify your existing `DMCONFIG` file to create a `DMCONFIG` file compatible with Tuxedo 8.

Note: It is recommended that you use the `osiadmin` utility to upgrade your `DMCONFIG` file, but you can perform this upgrade manually.

This section covers the following topics for manually upgrading your `DMCONFIG` file:

- [Upgrading From eLink OSI TP Version 1.3](#)
- [Upgrading From eLink OSI TP Version 4.0](#)

Upgrading From eLink OSI TP Version 1.3

To manually upgrade your `DMCONFIG` file for OSI TP Version 4.2, perform the following General Checklist steps. Each step is detailed in the following sections.

1. After installing eLink OSI TP 4.2 locate the original `DMCONFIG` file, referred to as `DMCONFIG.TXT`, and the `ositp` configfile you wish to upgrade and make backup copies of the files before making any modifications.

2. Modify the `DMCONFIG` file.

Following are the detailed steps for upgrading your `DMCONFIG` file:

Step 1 - Backup Existing Configuration Files

It is recommended that you make a backup copy of your original `DMCONFIG.TXT` file and `OSITP CONFIGFILE` before making any changes or running any utilities. A backup helps prevent the loss of your current configuration and allows you to restore any information in the event there is a problem. Enter the following command from your command line or DOS prompt to copy your `DMCONFIG.TXT` file to `DMCONFIG.bak`:

```
copy DCONFIG.TXT DCONFIG.bak
```

Step 2 - Modify Parameters in the DCONFIG File

You must change the `DM_OSITP` section name to `DM_OSITPX`, and you must modify the `TYPE` field in the `DM_LOCAL_DOMAINS` and `DM_REMOTE_DOMAINS` sections to be `TYPE=OSITPX`. In order to use some of the new features of OSI TP 4.2, you may optionally want to modify the `DM_LOCAL_SERVICES` and `DM_REMOTE_SERVICES` definitions as well. Changes to each of these sections consist of removing obsolete parameters, adding new parameters, and modifying values for existing parameters. You can modify entries in the `DMCONFIG` file using any text editor.

Following is a summary of the changes that need to be made to your configuration:

Section	Parameter	Change
<code>DM_OSITP</code>		Obsolete
<code>DM_OSITPX</code>		New

Step 2 - Modify Parameters in the DMCONFIG File

Section	Parameter	Change
DM_OSITPX	ACN	Obsolete
	AEID	Obsolete
	AEQ	Obsolete
	AET	Now required for each domain
	APID	Obsolete
	APT	Obsolete
	DNS_RESOLUTION	New
	MAX_LISTENING_EP	Obsolete
	NWADDR	Now required for each domain
	NWDEVICE	Obsolete
	OPTIONS	New
	P_SEL	New
	PROFILE	Obsolete
	S_SEL	New
	T_SEL	New
TAILOR_PATH	New	
URCH	Obsolete	
DM_LOCAL_DOMAINS	SECURITY	New
	TYPE=OSITP	Obsolete
	TYPE=OSITPX	New
DM_LOCAL_SERVICES	COUPLING	New
	INRECTYPE	New

B Manually Upgrading BEA eLink OSI TP to Version 4.2

Section	Parameter	Change
	OUTRECTYPE	New
DM_REMOTE_DOMAINS	TYPE=OSITP	Obsolete
	TYPE=OSITPX	New
CODEPAGE		New
DM_REMOTE_SERVICES	AUTOPREPARE	New
	INRECTYPE	New
	OUTRECTYPE	New
	REM_TPSUT	New
	TPSUT_TYPE (must be specified BEFORE REM_TPSUT)	New

Refer to Understanding the DMCONFIG File for more information about these new parameters.

Upgrading From eLink OSI TP Version 4.0

There are no changes required to the eLink OSI TP 4.0 UDMCONFIG input file. Perform a `dmloadcf` of this file to create a BDMCONFIG binary file compatible with Tuxedo 8.0. If your `ubbconfig` file contains eLink OSI TP 4.0 Administrative Server UDMADM, which is obsolete for eLink OSI TP 4.1 and 4.2, delete it and perform a `tmloadcf` of the modified `ubbconfig`.

Index

A

- Abstract Syntax Notation 1 (ASN.1)
 - 2-9
- access control
 - defining 4-38
- access control list
 - format 3-22
 - local domains 3-22
 - using wildcards 3-23
- ACL 3-25
- ACLIST 3-23
- addressing
 - application 3-2
 - format for DM_OSITPX 3-16
 - OSITP domains 3-16
- addressing information
 - defining 4-37
- administrative servers 1-11
- AET 3-18
- application address
 - OSI TP 3-2
- Application Entity Title (AET) 3-3
- architecture
 - eLink OSI TP 1-4
- ASN.1 encoding 2-9
- association 1-6
- audit log
 - local domain 3-12
- AUDITLOG 3-12
- AUTOPREPARE 3-28

B

- backup DMCONFIG.TXT file B-2
- BEA eLink OSI TP documentation
 - ix
- BEA eLink OSI TP Features 1-3
- BEA eLink Solution Overview 1-1
- blocking 3-12
- BLOCKTIME 3-12
- buffer 2-9
- buffer conversion
 - examples 2-22
 - View32 and FML 2-24
- buffers
 - data-dependent routing 3-30
 - encoding input 2-9
 - types 2-8
- BUFTYPE 3-31

C

- classes
 - grouping local domains 3-14
 - remote domains 3-15
- Client Support Centers -ix
- commitment protocol 2-6
- communications resource manager
 - 1-7
- components
 - eLink OSI TP server group 1-6
- configuration
 - defining new gateways 4-3

- configuration file
 - processing 4-41
- configuration parameters
 - records and buffers 2-11
- configuration prerequisites 4-1
- connection protocol
 - multiplexed 1-7, 3-2
 - non-multiplexed 3-2
- CONNECTIONSTATUS 5-5
- CONV 3-28
- COUPLING 3-25
- customer support
 - VAR -xiii

D

- DM_ACCESS_CONTROL
 - format 3-22
 - valid parameters 3-23
- DM_LOCAL_DOMAINS
 - format 3-11
 - parameter definitions 3-12
 - valid parameters 3-11
- DM_LOCAL_SERVICES
 - format 3-23
 - valid parameters 3-24
- DM_OSITPX
 - addressing information
 - requirement 3-16
 - format 3-16
 - valid parameters 3-16
- DM_REMOTE_DOMAINS
 - format 3-14
 - parameter definitions 3-15, 3-18, 3-23, 3-24, 3-28
 - valid parameters 3-15
- DM_REMOTE_SERVICES
 - format 3-26
 - valid parameters 3-27
- DM_ROUTING
 - format 3-30

- parameter definitions 3-31
- valid parameters 3-31
- DMADM A-1
- DMADMIN 1-10, A-1
- dmadmin A-2
- DMCONFIG
 - addressing information for OSITP domains 3-16
 - editing 4-34
 - file format 3-4
 - identifying local domains 3-11, 3-14
 - modifying the parameters 4-35
 - prerequisites 4-1
 - processing file 4-4
 - sample file 3-6
 - sections 3-5
 - understanding 3-1
- dmloadcf utility 4-4
 - diagnostics 4-44
 - how it works 4-43
 - invoking 4-42
 - process 4-41
- DMTLOG 3-13
- DMTLOGDEV 3-13
- DMTLOGNAME 3-13
- DMTLOGSIZE 3-13
- DNS_RESOLUTION 3-18
- documentation
 - BEA eLink OSI TP -ix
 - conventions -xiii
 - other publications -x
 - where to find it -viii
- domain components 1-10
- Domain transaction log 3-13
 - page size 3-13
- DOMAINID 3-13, 3-15
- domains
 - local 3-11
 - remote 3-14
- domains transaction management

2-2

E

ECHO 5-6

e-docs Web Site -viii

elements

- of OSI TP gateway 1-10

environment variables 4-2

F

features

- product 1-3

FIELD 3-31

G

gateways

- associated to local domains 3-11
- server group names 3-13

global transaction 2-2, 2-6

GWADM 1-10, A-22

- reference page A-22

GWGRP 3-13

I

IMPORTCFG 5-7

INBUFTYPE 3-25, 3-28

INRECTYPE 3-25, 3-28

L

LDM 3-25, 3-28, 5-7

LISTRDOM 5-7

local domain

- access control list 3-22
- audit log 3-12
- class groups 3-14
- format for

DM_LOCAL_DOMA
INS 3-11

- identifying 3-11
- naming 3-11
- routing requests to remote service 3-28
- services exported 3-23

local domains

- defining 4-35

local Tuxedo services

- defining 4-39

locally originated service calls 2-12

log

- transaction 3-13

loosely coupled transactions 2-2

M

mapping buffers to records 2-18

mapping records to buffers 2-20

MAXRDTRAN 3-13

MAXTRAN 3-13

multiplexed protocol 1-7

N

NWADDR 3-20

O

ONLINERDOM 5-8

Open Systems Interconnection 1-8

Open Systems Interconnection (OSI) 1-8

OPTIONS 3-21

OSI

- architecture 1-8
- benefits of 1-8
- Reference Model 1-8

osiadmin

- executing commands 5-4

- getting help 5-5
- initiating 5-2
- initiating in batch mode 5-4
- initiating in interactive mode 5-4
- initiating in script mode 5-3
- overview 5-1
- osiadmin commands 5-5
- OSIRUNDIR, 4-3
- OSI-TP protocols 1-2
- OUTBUFTYPE 3-26, 3-29
- OUTRECTYPE 3-26, 3-29
- overview
 - eLink OSI TP 1-1

P

- P_SEL 3-21
- parameter definitions
 - DM_LOCAL_DOMAINS 3-12
 - DM_REMOTE_DOMAINS 3-15, 3-18, 3-23, 3-24, 3-28
 - DM_ROUTING 3-31
- parameters
 - valid for
 - DM_ACCESS_CONTROL 3-23
 - valid for
 - DM_LOCAL_SERVICES 3-24
 - valid for DM_OSITP 3-16
 - valid for
 - DM_REMOTE_SERVICES 3-27
 - valid for DM_ROUTING 3-31
 - valid in
 - DM_LOCAL_DOMAINS 3-11
 - valid in

- DM_REMOTE_DOMAINS 3-15
- printing product documentation -viii
- problems, reporting software -xii
- processing DMCONFIG file 4-4
- protocol layers 1-9

R

- RANGES 3-32
- RDOM 3-29
- record 2-9
- record processing
 - local programs 2-9
 - remote programs 2-10
- reference pages
 - DMADM A-1
 - dmadmin A-2
 - GWADM A-22
- related information -ix
- REM_TPSUT 3-21
- remote domain
 - classes 3-15
 - data-dependent routing 3-30
 - format for
 - DM_REMOTE_DOMAINS 3-14
 - format for
 - DM_REMOTE_SERVICES 3-26
 - identifying 3-14, 3-15
 - imported services 3-26
 - RDOMs in access control list 3-23
 - restricting services 3-25
 - service execution 3-27, 3-29
- remote domains
 - defining 4-36
- remote service
 - routing request to 3-28
- remote services

- defining 4-40
- remote systems
 - receive requests 1-5
 - replies 1-5
- requests
 - routing to remote service 3-28
- Resource Manager (RM) 2-2
- RNAME 3-26, 3-29
- ROUTING 3-30
- routing
 - data-dependent 3-30
 - format for DM_ROUTING 3-30
 - requests to remote service 3-28
 - service requests for typed buffers 3-30
- routing information
 - defining 4-40

S

- S_SEL 3-21
- SECURITY 3-14
- servers
 - Domain administration 1-11
- services
 - execution by remote domain 3-27, 3-29
 - exported by local domains 3-23
 - format for
 - DM_LOCAL_SERVICES 3-23
 - imported on remote domains 3-26
 - restricting requests by remote domains 3-25
- Support Online -xi
- SURETY Support Services -x

T

- T_SEL 3-21
- TAILOR file 4-46
 - description 4-44
 - parameters 4-44
- TAILOR_PATH 3-22
- Tech Advantage -xii
- TESTCONNECTION 5-9
- tightly coupled transactions 2-2
- TPSUT_TYPE 3-30
- TRACE 5-9
- transaction across domains 2-6
- transaction log
 - name 3-13
- transaction management 2-1
- Transaction Manager (TM) 2-2
- Transaction Manager Servers (TMS) 2-2
- transaction processing services 1-9
- transaction recovery 2-7
- transaction tree 2-2
- TRANTIME 3-30
- tuning OSI TP-specific tables 4-44
- TUXEDO system
 - recognizing Connect OSI TP servers 4-4
- TYPE 3-14, 3-15
- typed buffers 2-8
 - data-dependent routing 3-30

U

- UBBCONFIG file
 - sample 4-5
- Unisys customer support -x
- Upgrading BEA eLink OSI TP B-1
- upgrading BEA eLink OSI TP 4-34

V

- VAR Customer Support -xiii

W

wildcards

access control lists 3-23

X

XATMI 2-8

XATMI ASE 2-8

XATMI_ENCODING 3-22

XID 2-2